

Radio Powr Savr™ Wireless Occupancy/Vacancy Ceiling Sensor

Lutron® Radio Powr Savr™ occupancy/vacancy sensors are wireless, battery-powered passive infrared (PIR) sensors that automatically control lights via RF communication to compatible dimming and switching devices. These sensors detect the heat from people (IR radiation of 9.5 μm) moving within an area to determine when the space is occupied. The sensors then wirelessly transmit the appropriate commands to the associated dimming and switching devices to turn the lights on or off automatically. They combine both convenience and exceptional energy savings potential along with ease of installation.

Features

- Wireless occupancy sensor has 3 settings available: Auto-On/Auto-Off, Auto-On Low-Light/Auto-Off, and Manual-On/Auto-Off
- Auto-On Low-Light feature will only turn lights on automatically if there is less than approximately 10 Lux (1 fc) of ambient light
- Vacancy only model available to meet California (U.S.A.) Title 24 requirements
- Uses Clear Connect® technology
- Passive infrared motion detection with exclusive Lutron® XCT™ Technology for fine motion detection
- 360° coverage ranges from 324 ft² (30.2 m²) to 676 ft² (62.4 m²), depending on mounting height
- Simple and intuitive adjustments available for Timeout, Auto-On, and Activity settings
- Supports advanced occupancy features, such as dependent occupancy groups and customizable occupied/unoccupied presets in some systems
- Multiple sensors can be added for extended coverage—refer to product specification submittal of receiving device to determine system limits
- Lens illuminates during test mode to verify ideal locations
- Multiple ceiling-mount methods available for different ceiling materials
- Front accessible test buttons make programming easy
- 10-year battery life design
- RoHS compliant

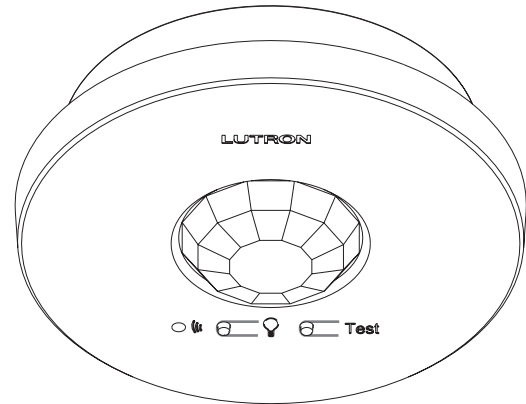

Models Available

- LRF__-OCR2B-P-WH
 - Color Code
 - Occupancy and Vacancy
 - Frequency/Channel Code
- LRF2-VCR2B-P-WH
 - Vacancy Only
 - Available for Channel Code 2 Only

Frequency/Channel Codes

Available

2 = 431.0 – 437.0 MHz (U.S.A., Canada, Mexico, Brazil)

5 = 865.5 – 866.5 MHz (India)

6 = 312.3 – 314.8 MHz (Japan)

7 = 433.05 – 434.79 MHz (Hong Kong)

Color Code

WH = White

Compatible RF Devices

- For use with Lutron® products only
- Communicates to various wireless Lutron® systems*

* Contact Lutron® Customer Service at www.lutron.com for frequency/channel code compatibility with your particular geographic region, and for integrating with other Lutron® lighting and shading products.

Job Name:

Model Numbers:

Job Number:

Specifications

Regulatory

- Lutron® Quality Systems Registered to ISO 9001:2008

Standards Approved

LRF2- (USA and Canada)

- FCC certified
- IC certified
- Meets CA (U.S.A.) Energy Commission Title 24 requirements
- COFETEL
- ANATEL
- SUTEL

LRF5-

- WPC Type (India)

LRF6-

-  007YUUL0689

LRF7-

- FCC

Power/Performance

- Operating voltage: 3 V⁻⁻⁻
- Operating current: 14 µA nominal
- Requires one CR 123 lithium battery
- 10-year battery life
- Non-volatile memory (saved changes are stored during power loss)

Environment

- Temperature: 32 °F to 104 °F (0 °C to 40 °C)
- For indoor use only

Range

• LRF2-, LRF5-, LRF7-

Local load controls must be located within 60 ft (18 m) line of sight, or 30 ft (9 m), through walls, of a sensor.

• LRF6-

Local load controls must be located within 40 ft (12.2 m) line of sight or 23 ft (7 m), through walls, of a sensor.

Sensor Coverage Test

- Front accessible test button
- Lens illuminates orange in response to motion during test mode and is visible from 60 ft (18 m)

Wireless Communication Test

- Front accessible test button
- Turn associated loads on and off



Timeout Options

- 1 minute *
- 5 minutes
- 15 minutes – default setting
- 30 minutes

Auto-On Options (Occupancy Versions Only)

- “Enabled” – Sensor turns lights ON and OFF automatically – default setting.
- “Low Light” – Sensor turns lights ON automatically only in low ambient light conditions. Sensor turns lights OFF automatically.
- “Disabled” ** – Lights must be turned ON manually from dimming or switching device. Sensor turns lights OFF automatically.

Activity Options

- Low Activity () – default setting
- Medium Activity ()
- High Activity ()

* Intended for use in high-activity, briefly occupied areas only

** There is a 15-second grace period that begins when the lights are automatically turned off, during which the lights will automatically turn back on in response to motion. This grace period is provided as a safety and convenience feature in the event the lights turn off while the room is still occupied, so that the user does not need to manually turn the lights back on. After 15 seconds, the grace period expires and the lights must be manually turned on.

Job Name:	Model Numbers:
Job Number:	

Installation Overview

Sensor Setup

- Sensor setup is available as a service by Lutron. For more information see the **Sensor Layout and Tuning** service document (Lutron® P/N 3601235).

Sensor Placement

- The ability of the sensor to detect motion requires line of sight of room occupants. The sensor must have an unobstructed view of the room. **DO NOT** mount behind or near tall cabinets, shelves, hanging fixtures, ceiling fans, etc. The sensor cannot see through glass objects such as patio or shower doors.
- Hot objects and moving air currents can affect the performance of the sensor. To ensure proper operation, the sensor should be mounted at least 4 ft (1.2 m) away from HVAC vents and light bulbs that are below the ceiling line.
- The performance of the sensor depends on a temperature differential between the ambient room temperature and that of room occupants. Warmer rooms may reduce the ability of the sensor to detect occupants.

Mounting

Temporary mounting is optional to test sensor coverage and wireless communication before permanently installing the sensor.

Drop Ceiling (Compressed Fiber Ceiling Tile)

The mounting wire is provided for both temporary and permanent mounting of the sensor to ceiling tiles. It is designed to allow temporary mounting, testing, and repositioning (if necessary) of the sensor without damaging a ceiling tile. Once the final position of the sensor has been chosen, the mounting wire should be twisted together to permanently secure the sensor in place.

Solid Ceiling (Drywall, Plaster, Concrete, or Wood)

- Temporary mounting: Ten (10) temporary mounting strips can be purchased in the kit L-CMDPIRKIT for temporarily mounting and testing the sensor.
- Permanent mounting: Screws and anchors (for drywall or plaster) provided to mount the sensor.

Recess Mount

- Do not recess mount sensor in a metal surface.
- Recess mounting ring requires an opening of 3 in (76 mm) in diameter.
- Recess mounting ring secures internally to ceiling. Sensor twists into the recess mounting ring and sits flush with ceiling (see image to right).
- Recess mounting ring purchased as a separate kit: L-CRMK-WH.

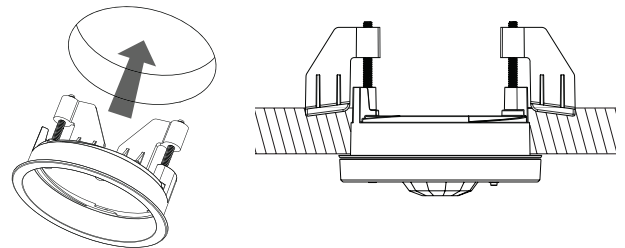

<p>Job Name:</p> <p>Job Number:</p>	<p>Model Numbers:</p>
--	-----------------------

Dimensions

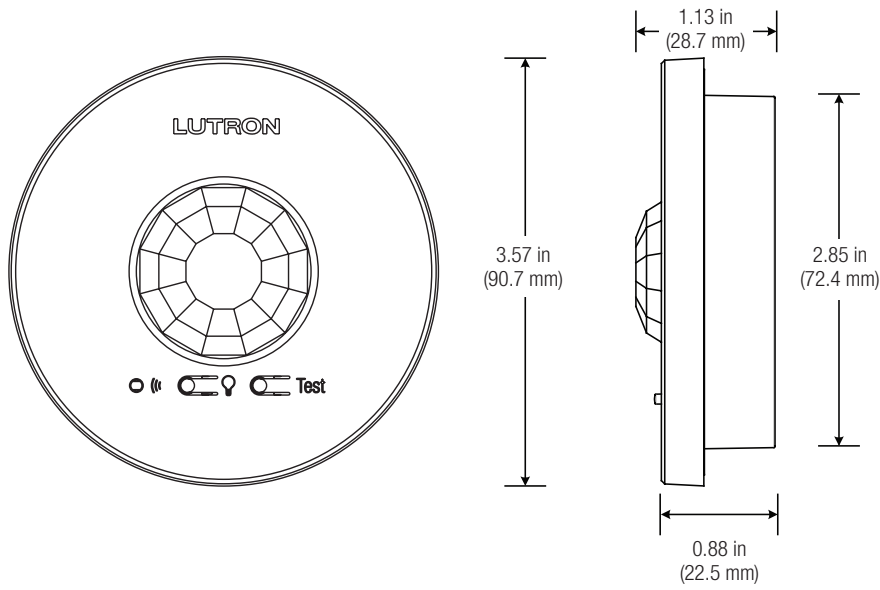

Job Name:	Model Numbers:
Job Number:	

Range Diagrams

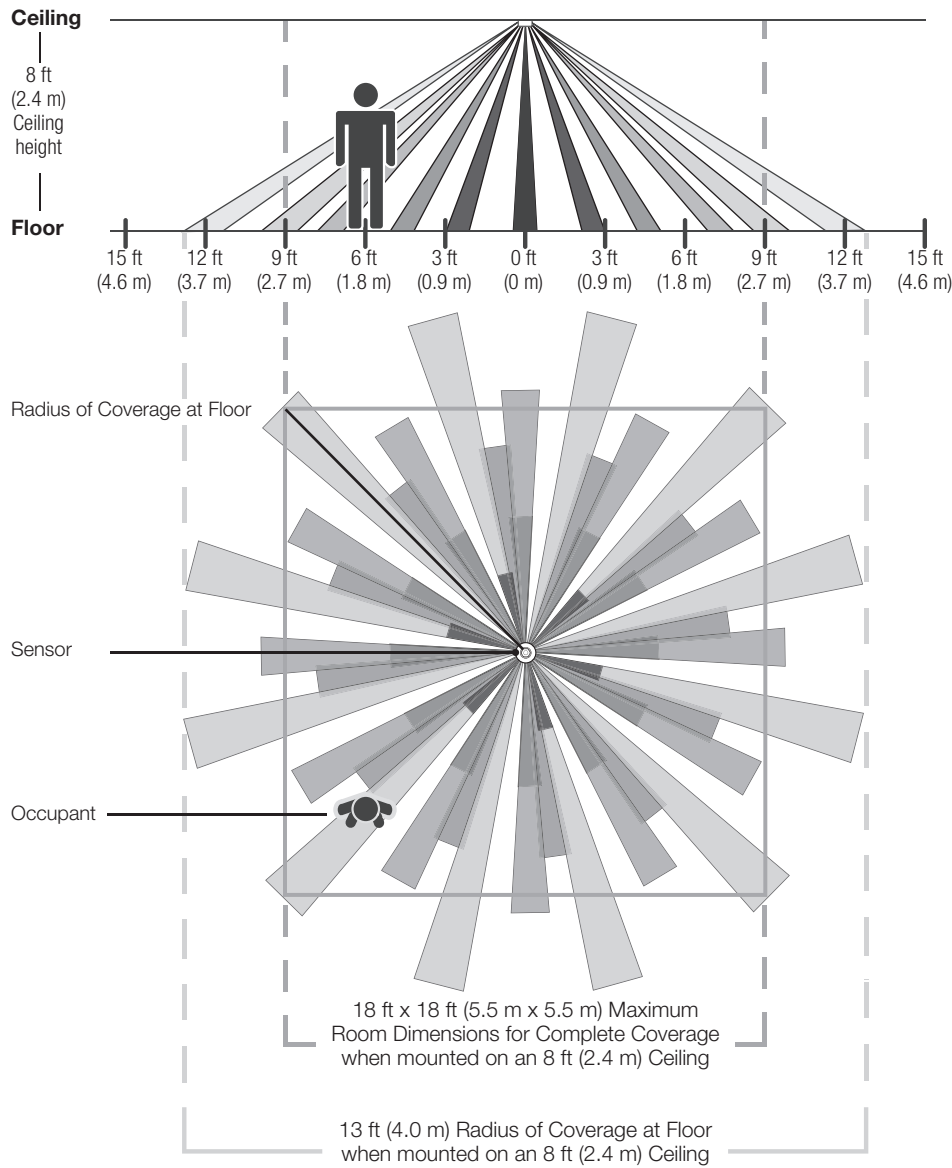

Sensor Coverage Chart (for sensor mounted in center of room)

Ceiling Height	Maximum Room Dimensions for Complete Floor Coverage*	
8 ft (2.4 m)	18 ft x 18 ft (5.5 m x 5.5 m)	324 ft ² (30.2 m ²)
9 ft (2.7 m)	20 ft x 20 ft (6.1 m x 6.1 m)	400 ft ² (37.2 m ²)
10 ft (3.0 m)	22 ft x 22 ft (6.7 m x 6.7 m)	484 ft ² (44.9 m ²)
12 ft (3.7 m)	26 ft x 26 ft (7.9 m x 7.9 m)	676 ft ² (62.4 m ²)

* 12 ft (3.7 m) is the recommended maximum mounting height

Job Name:	Model Numbers:
Job Number:	

Lens Masking

Whenever possible, the sensor should be installed in a location where it cannot view areas outside the intended space, such as hallways or adjacent rooms. If this situation cannot be avoided, portions of the lens may be masked to block the view of the sensor into undesired areas. Ten (10) PIR Lens Masks can be purchased in the kit L-CMDPIRKIT.

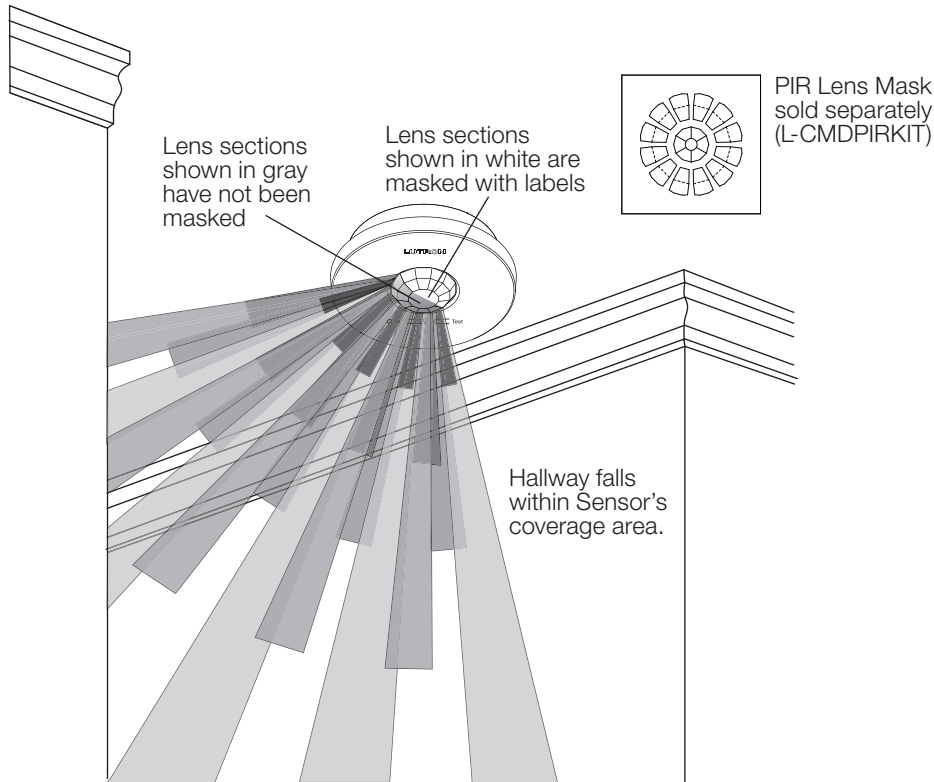

Job Name:	Model Numbers:
Job Number:	