



[Catalog Home](#)

**Product Datasheet**

**ANDERSON FARGO**

**GA105L -- Hot Line Connector**

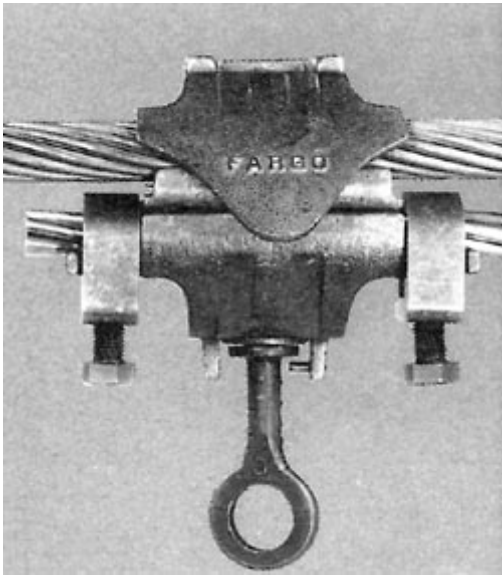

Overhead Primary Tap Connector, Hot Line Tap Connector, Aluminum, AAC|AAAC|ACSR, Range 0.502 - 0.741 in.

**Product Specifications**

<p><b>Series</b></p>	 <p><b>GA-100 Series</b> Hot Line Tap Connector Aluminum Fargo Vise Type Design</p>
<p><b>PDF Catalog Page</b></p>	<p><a href="#">Click HERE to view the web page.</a></p>
<p><b>Plating</b></p>	<p>None</p>
<p><b>Packaging</b></p>	<p>Inhibitor &amp; Bagged</p>
<p><b>Body and Keeper Material</b></p>	<p>Aluminum</p>
<p><b>Eyebolt Material</b></p>	<p>Aluminum Alloy</p>
<p><b>Eyestem Material</b></p>	<p>Forged Aluminum Alloy</p>
<p><b>Spring (on Eyestem) Material</b></p>	<p>Stainless Steel Bellville</p>
<p><b>Dimension A</b></p>	<p>6 in</p>
<p><b>Dimension B</b></p>	<p>3 7/8 in</p>
<p><b>Dimension C</b></p>	<p>3 in</p>
<p><b>Dimension D</b></p>	<p>2 7/8 in</p>
<p><b>Maximum Current Rating Amps Continuous</b></p>	<p>Rated for maximum current of both Main &amp; Tap Conductors</p>
<p><b>Minimum / Maximum Run Conductor</b></p>	<p>AAC 4/0 str (7) Thru AAC 2/0 str (19) w/Armor Rods AAAC 3/0 str(7) Thru AAAC 1/0 str(7) w/Armor Rods ACSR 3/0 (6/1) Thru ACSR 1/0 (6/1) w/Armor Rods</p>
<p><b>Minimum Run Conductor Size</b></p>	<p>0.502</p>
<p><b>Maximum Run Conductor Size</b></p>	<p>0.741</p>
<p><b>Minimum Tap Conductor Size</b></p>	<p>0.502</p>

<b>Maximum Tap Conductor Size</b>	0.741
<b>Minimum / Maximum Tap Conductor</b>	AAC 4/0 str (7) Thru AAC 2/0 str (19) w/Armor Rods AAAC 3/0 str(7) Thru AAAC 1/0 str(7) w/Armor Rods ACSR 3/0 (6/1) Thru ACSR 1/0 (6/1) w/Armor Rods Cu 4/0 str (7) Thru Cu 2/0 str (19) w/Armor Rods
<b>Material Type</b>	Standard
<b>UPC Code</b>	09635930421
<b>Standard Package</b>	25
<b>Standard Package Unit</b>	Each
<b>Min Order Qty</b>	25
<b>Weight / Ea.</b>	0.941 lbs

### Notes

Vise type action develops vibration proof connection, inhibitor loaded.

### Features

For full duty connections involving major line equipment and apparatus or main to main connections.

### Compressed Product Number

GA105L

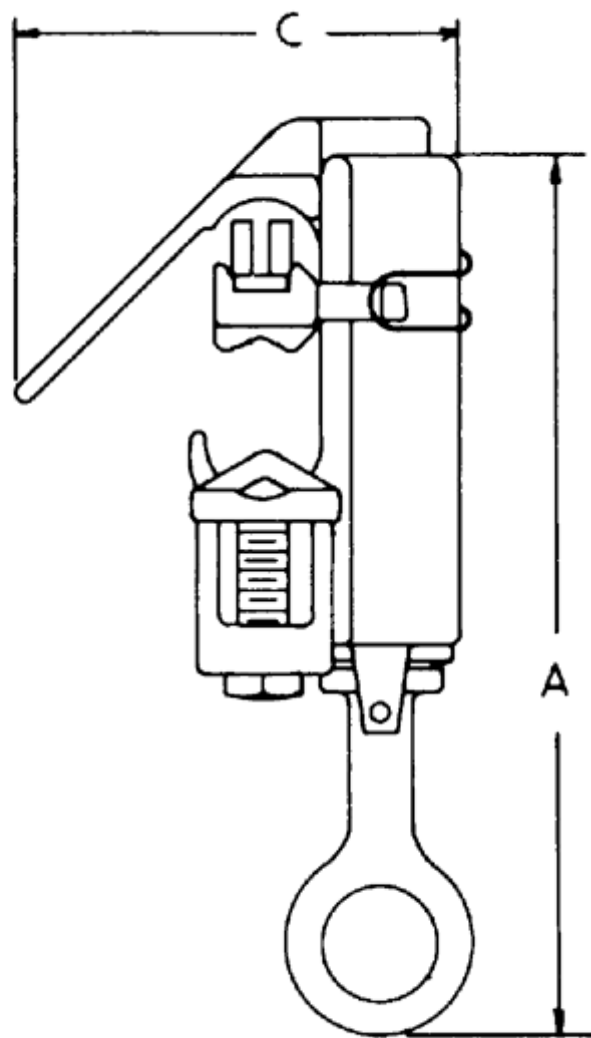
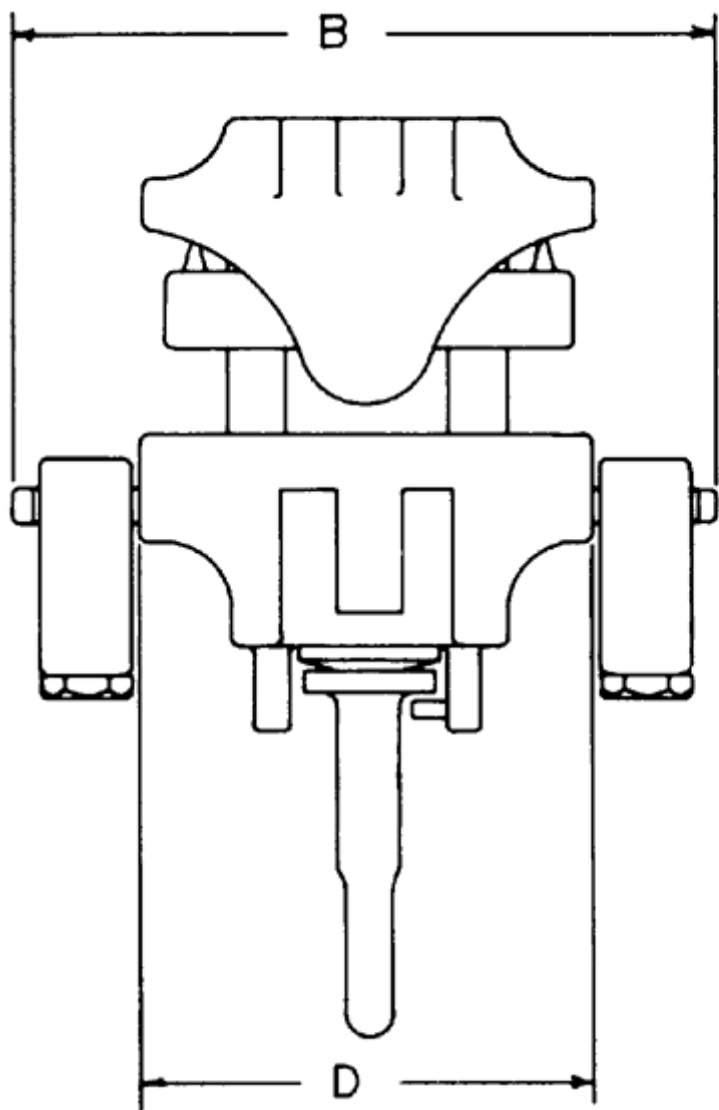

Dwg ref dim A,B, C, & D

**OVERHEAD PRIMARY TAPS  
ADDITIONAL ACCESSORIES  
ALUMINUM AND BRONZE**

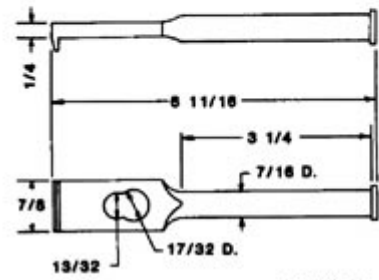
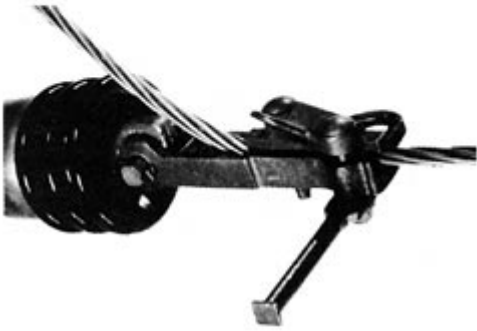

GH-296A

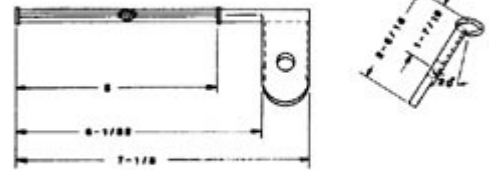
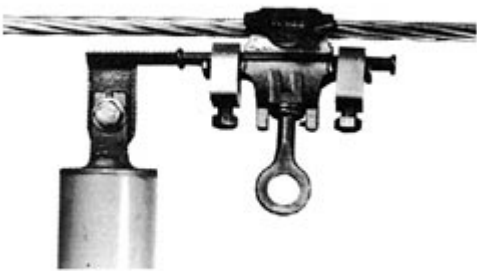

GA-300-FSK

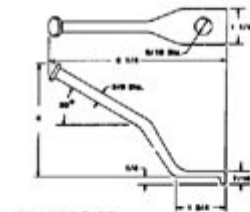

GH-280C-30

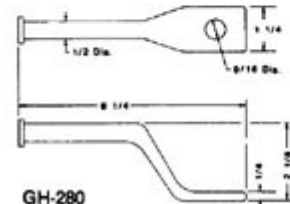

GH-280

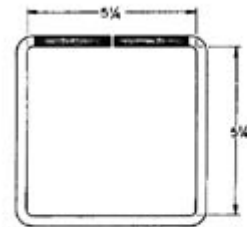

GH-282 1/4" Dia. Copper Rod  
GH-284 3/8" Dia. Copper Rod  
GH-286 1/2" Dia. Copper Rod

Additional Accessories



[Warranty Info](#) | [Trademarks](#) | [Terms of Use](#)

*All contents Copyright © 2007 Hubbell Power Systems, Inc. All rights reserved.*

NOTE: Because Hubbell has a policy of continuous product improvement, we reserve the right to change design and specifications without notice.