

**3M** Science.  
Applied to Life.™



# 3M Packaging Solutions Guide

Right tapes.  
Right system.  
Right partner.

Industrial Specialties Division - Packaging  
September 2024

# At 3M, we never forget our success was sealed by a roll of tape.

A single inventive way of solving a customer's problem more than ~100 years ago led to a breakthrough that became known as "Scotch® Tape"; an invention that changed the world. Today, the curious minds at 3M continue to maintain the legacy of the original Scotch® Tape by meeting customer needs everyday and never compromising on performance.

Reliable performance proven over time has formed a bond of trust with Scotch® Tape. This is why it remains the number one brand for packaging, bundling, reinforcing solutions and more. At 3M, we stake our reputation on delivering the very best, most reliable tapes every day so you can trust Scotch® Tape to protect your reputation, as well.

You can double down on dependability by combining Scotch® Box Sealing Tapes with 3M-Matic™ Case Sealers. With nearly a half-century of experience in building case sealing equipment, 3M delivers the "total package" in packaging systems.

In a world where so many unexpected events can impact your results, Scotch® Tapes and 3M packaging solutions have got you covered — with dependable, high quality products and systems to meet your ever-changing requirements.

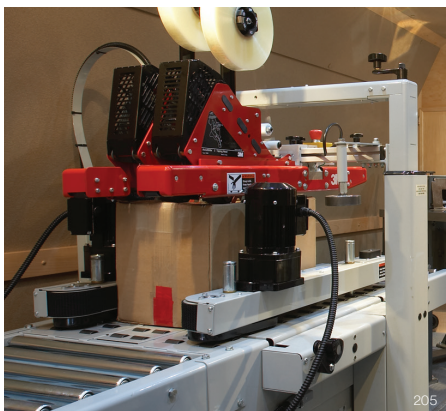

# Right tapes. Right system. Right partner.

## 3M Packaging Solutions



### Packaging Equipment and Dispensers

3M-Matic™ Case Sealers Selection Overview .....	6-7
3M-Matic™ Adjustable Case Sealers .....	8-9
3M-Matic™ Random Case Sealers .....	10
3M™ AccuGlide™ Taping Head Technology .....	11-12
Customized 3M-Matic™ Equipment .....	12
Non-RSC Closure Solutions.....	13
3M-Matic™ Case Sealers Replacement Parts and Accessories .....	14
Scotch® and Tartan™ Manual Tape Dispensers.....	15-17
3M Systems Tape Agreement .....	18-19



### Box Sealing Tapes

Scotch® Box Sealing Tapes Overview .....	21
Box Sealing Tape Selector .....	22
Scotch® and Tartan™ Box Sealing Tapes.....	23
Scotch® Plus+ Series Tapes .....	24
Scotch® Custom Printed Box Sealing Tapes.....	25
Scotch® Cold Temperature Tape.....	26
3M™ Water Activated Tapes.....	27
Scotch® Security Tapes .....	27
Scotch® Specialty Box Sealing Tapes .....	25
Light Duty Packaging Tapes .....	28-29
Scotch® Performance Paper Box Sealing Tape 570 .....	40



### Custom Packing Solutions

3M™ Carry Handles.....	31-32
Scotch Multipack Tapes.....	33
3M™ Tape Pads .....	34
3M™ Hang Tabs.....	34
Scotch® Pouch Tapes.....	35
Label Protection Tapes .....	36
3M™ Packing List Envelopes .....	37



### Sustainable Solutions

PACR (Padded Automatable Curbside Recyclable Mailer Material).....	40
Scotch® Performance Paper Box Sealing Tape 570 .....	40

<b>Glossary</b> .....	39-40
-----------------------	-------

<b>Numerical Index</b> .....	41
------------------------------	----

<b>Product Name Index</b> .....	42-43
---------------------------------	-------

**3M-Matic**  
Case Sealing Systems

**ERECTING & PACKING**

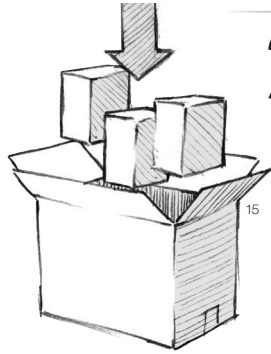

Case erectors  
Ergo packs

Throughput & speed

3M™ AccuGlide™ Tape  
Head Technology

**3M-Matic**  
Case Sealing Systems

Consistency  
Security  
Protection

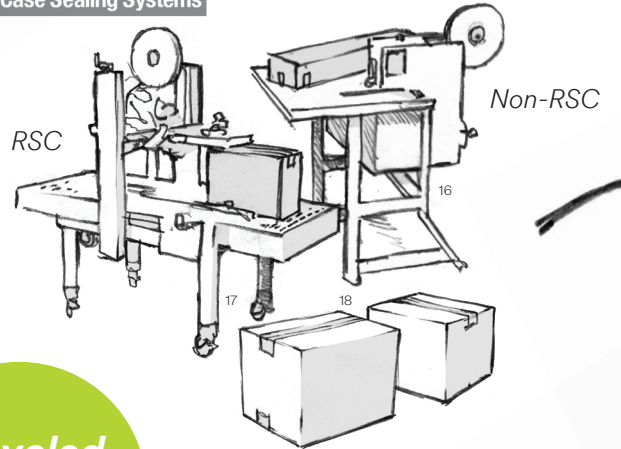

**SEALING**

Semi-automatic  
Hand applied



Recycled  
corrugate?  
No problem!

**Scotch**

Protection  
Control  
Security

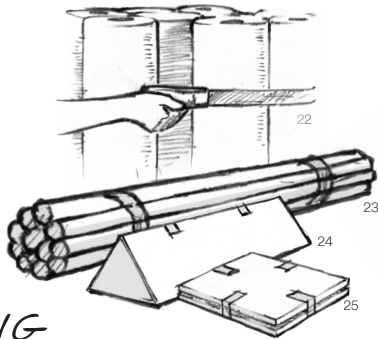

**BUNDLING**

**L-CLIP CLOSURE**

**Tech support**  
Before & after  
the sale

**PACKING STATIONS**

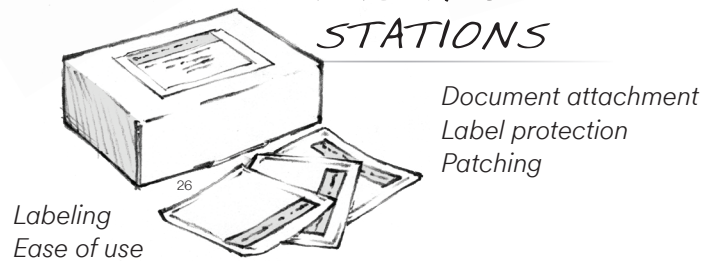

# The Total Package

Pack it. Close it. Move it. Sell it. Use it.

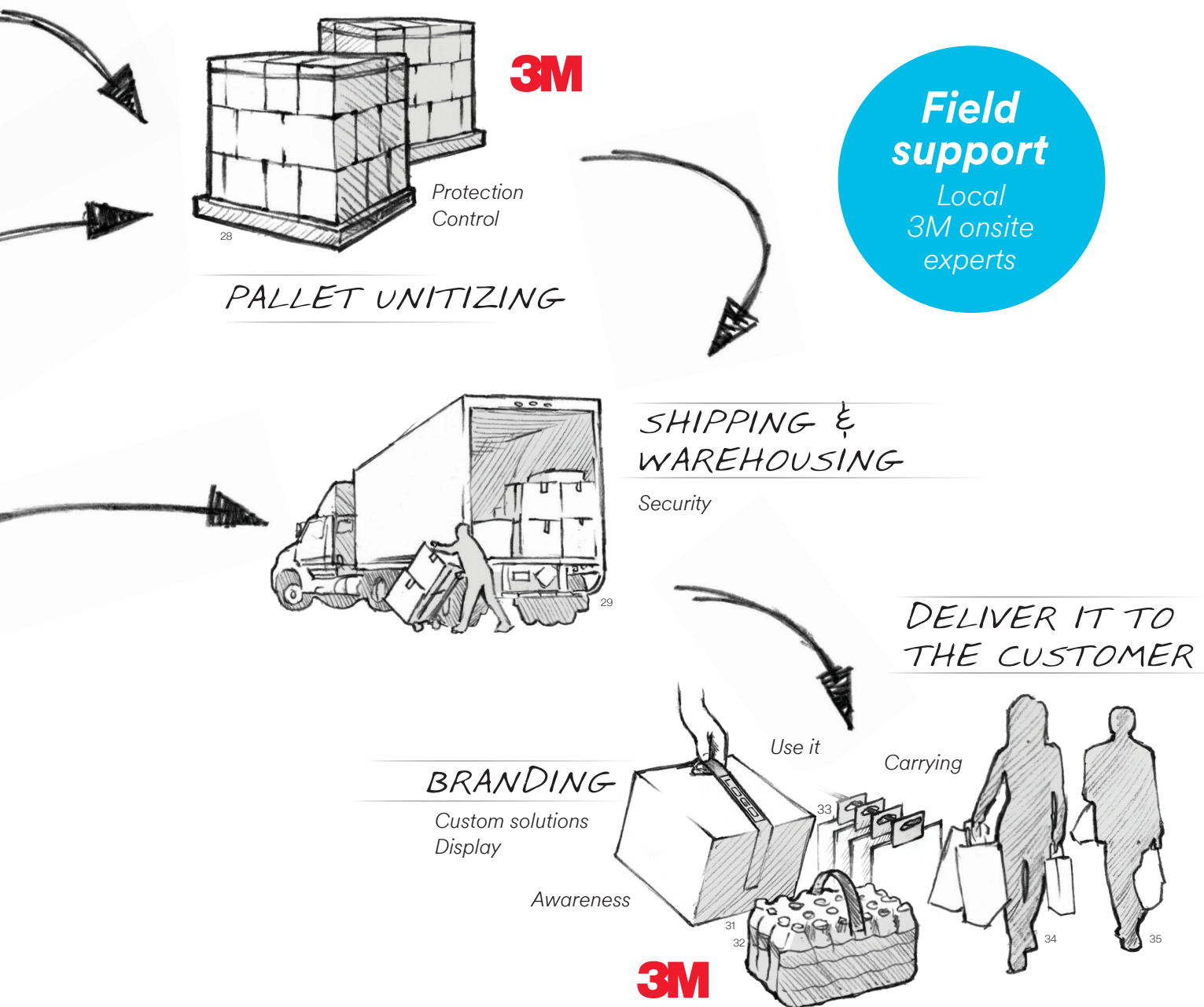



# Packaging Equipment & Dispensers

How do you get your packages securely sealed, out the door and into the hands of your customers in the fastest, most efficient manner? It starts with 3M-Matic™ Case Sealers. For 55 years, packaging facilities everywhere have relied on these productivity-enhancing solutions for consistent, efficient case sealing, day after day.



**55<sup>TH</sup>**  
**3M-Matic™**  
Case Sealers  
ANNIVERSARY CELEBRATION  
Consistent. Reliable. Tough.  
**3M**



**3M-Matic™**  
Case Sealing Systems

## 3M-Matic™ Case Sealer

### Things to Consider When Selecting a Case Sealer

**1**

**Do you pre-form your boxes?  
What style box do you use?**

- RSC (Regular Slotted Carton)
- FPF (Five Panel Fold)
- Full overlap

**3**

**What closure method do you use?**

- RGT (Reinforced Gum Tape)
- Pressure-sensitive box sealing tape
- Glue
- Staples

**2**

**How many boxes do you  
seal per day?**

**4**

**Do you seal your boxes  
in uniform or random  
production runs?**

# 3M-Matic™ Case Sealers Selection Overview



38

For Sealing Uniform Size Boxes

## Manually Adjustable, Semi-Automatic



### 8000af

210

Up to 40 cs/min  
Up to 85 lbs  
Side belt drives

\*Available with 3 inch taping head.

## Manually Adjustable, Semi-Automatic

### Affordable for Low Volume



### 2000a\*

211

Up to 40 cs/min  
Up to 85 lbs  
Bottom belt drive



### 7000a Pro

195

Up to 40 cs/min  
Up to 85 lbs  
Top/bottom belt drives



### 8000a

191

Up to 40 cs/min  
Up to 85 lbs  
Side belt drives

\*Available with 3 inch taping head.

## Manually Adjustable, Semi-Automatic

### Affordable for Low Volume



### 8000ab\*

211

Up to 40 cs/min  
Up to 85 lbs  
Bottom belt drive



### 8000asb

195

Up to 40 cs/min  
Up to 85 lbs  
Top/bottom belt drives



### 700a-s

191

Up to 40 cs/min  
Up to 85 lbs  
Side belt drives









# 3M-Matic™ Case Sealers Selection Overview





39

## For Sealing Various Size Boxes

 <p><b>8000r<sup>†</sup></b> Up to 10 cs/min Up to 200 lbs</p>	 <p><b>800rks<sup>†</sup></b> Up to 10 cs/min Up to 200 lbs Top/bottom side belt drives</p>	 <p><b>7000r Pro*</b> Up to 24 cs/min Up to 85 lbs Top/bottom belt drives</p>	 <p><b>7000r HS Pro*</b> Up to 28 cs/min Up to 60 lbs Top/bottom belt drives</p>
---	--	---	---

\*Available with 3 inch taping head.  
†Comes standard with 3 inch taping head.

Non-RSC Box	
 <p><b>S867</b> 3M-Matic™ L-Clip Applicator S867 is a semi-automatic unit that applies 4.5 inch L-Clips of Scotch® Filament Tapes and Scotch® Box Sealing Tapes at up to 50 clips/min.</p>	 <p><b>S867 II</b> 3M-Matic™ Dual L-Clip Applicator S867 II applies two 4.5 inch L-Clips of Scotch® Filament or Reinforced Strapping Tape on the same edge at up to 50 clips/min.</p>

### 3M-Matic Helpline: 1-800-328-1390

When you have a question, simply call the toll-free helpline, open to take your calls Monday through Friday, 8:00am to 4:30pm Eastern Standard Time. Messages will be taken 24 hours a day for next working day response.

Belt Drive Key
2 = Bottom belt drives
7 = Top and bottom belt drives
8 = Side belt drives

Box Type
a = Adjustable, for batch runs
r = Random, for mixed runs

Additional Capability
b = Bottom only
f = Flap folding
ks = King size
sb = Small box

# 3M-Matic™ Adjustable Case Sealers



## Gain productivity with quick height and width adjustments.

With quick manual adjustment, these rugged units reliably and accurately seal runs of the same size cartons for a variety of markets: food and beverage, medical devices, pharmaceutical, electronics, retail, manufacturing and distribution centers to name a few.

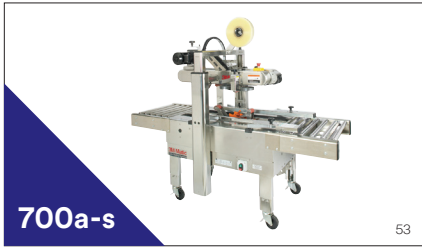

### 3M-Matic™ Adjustable Case Sealer 700a-s

has advanced features to seal uniform cases at up to 30 per minute. Dual masts with dual lead screws for stability and uniform height adjustments. Adjustable top and bottom belt drive system for reliable conveyance of heavier or tall/light boxes. Compression rollers position each box for precise tape sealing. Stainless construction for corrosive environments.

### 3M-Matic™ Case Sealer 2000a Now with 3M™ AccuGlide™ NPH+ Taping Head, is an adjustable bottom belt drive case sealer to dependably seal uniform

### 3M-Matic™ Adjustable Case Sealer 7000a Pro is an adjustable top and bottom belt drive to dependably seal uniform cases at up to 40 per minute.

## Bottom Belt Drive Systems

Machine	Drive System	Box Size Capacity (inches)						Power Requirements		Operating Rate (cs/min)	Belt-Drive Speed (ft/min (m/s))	Taping Head	Comments
		Minimum			Maximum			Electrical	Air				
		L	W	H	L	W	H						
2000a	Bottom	6.0	6.5	4.5 [3.75]	N/L	21.5	24.5 [28.5]	115VAC 60Hz 1.9A 220W	No Air	Up to 40	100 (0,5)	3M™ AccuGlide™ NPH+ Taping Head	Semi-Automatic Adjustable
2000a3			7.5									3" 3M™ AccuGlide™ 3	

Standard size capabilities are listed above. If additional sizes can be met, they are indicated by [Taping Head] or [Machine Configuration]. Changing the taping head or machine configuration will allow for enhanced box height range indicated in the chart above. Please refer to the Instructions and Parts List or 3M representative for more detail.

## Top and Bottom Belt Drive Systems

Machine	Drive System	Box Size Capacity (inches)						Power Requirements		Operating Rate (cs/min)	Belt-Drive Speed (ft/min (m/s))	Taping Head	Comments
		Minimum			Maximum			Electrical	Air				
		L	W	H	L	W	H						
700a-s	Top and Bottom	6.0	6.0	4.75	N/L	21.5	24.5	115VAC 60Hz 3.8A 440W	No Air	Up to 30	78 (0,4)	2" 3M™ AccuGlide™ 2+ Stainless Steel	For Corrosive Environment
7000a Pro	Top and Bottom	6.0	6.5	4.75	N/L	26.5	28.0	115VAC 60Hz 3.8A 440W	No Air	Up to 40	100 (0,5)	2" 3M™ AccuGlide™ 3	Extended size capabilities are possible, please contact 3M
7000a3 Pro												3" 3M™ AccuGlide™ 3	

Standard size capabilities are listed above. If additional sizes can be met, they are indicated by [Taping Head] or [Machine Configuration]. Changing the taping head or machine configuration will allow for enhanced box height range indicated in the chart above. Please refer to the Instructions and Parts List or 3M representative for more detail.



# 3M-Matic™ Adjustable Case Sealers

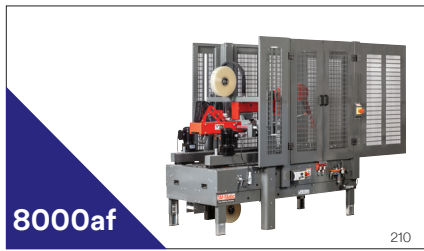

**8000af**

210

**3M-Matic™ Case Sealer 8000af** is an automatic flap folding machine that seals both the top and bottom of a box without an operator.



**8000a**

191

**3M-Matic™ Side Belt Adjustable Case Sealer 8000a** is an adjustable side belt drive case sealer. Seals up to 40 cases per minute, using tape widths from 36mm to 48mm, and also 72mm tape.



**8000asb**

194

**3M-Matic™ Case Sealer 8000asb** with 3M™ AccuGlide™ NPH Taping Head is a manually adjustable side belt drive case sealer. Seals up to 30 cases per minute, using tape width of 36 - 48mm.

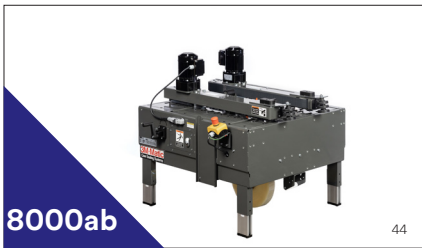

**8000ab**

44

**3M-Matic™ Case Sealer 8000ab** is an adjustable side belt drive case sealer. Applies bottom seal only at rates up to 40 cases per minute, using tape widths from 36mm to 48mm, and also 72mm tape.

## Side Belt Drive Systems

Machine	Drive System	Box Size Capacity (inches)						Power Requirements		Operating Rate (cs/min)	Belt-Drive Speed (ft/min (m/s))	Taping Head	Comments
		Minimum			Maximum			Electrical	Air				
		L	W	H	L	W	H						
8000a	Side	6.0	4.5	4.75	N/L	21.5	28.5	115VAC 60Hz 3.8A 440W	No Air	Up to 40	100 (0.50)	2" 3M™ AccuGlide™ 3	Extended size capabilities are possible, please contact 3M
8000a3			5.5	4.75			28.5					3" 3M™ AccuGlide™ 3	
8000ab	Side	6.0	3.625	2.75	N/L	21.5	21.5	115V 60Hz 3.8A	No Air	Up to 30	100 (0.50)	3M™ AccuGlide™ NPH Taping Head	Bottom Taping Only
8000ab3	Side	6.0	4.5	2.75	N/L	21.5	N/L	115VAC 60Hz 3.8A 440W	No Air	Up to 40	100 (0.50)	3M™ AccuGlide™ NPH Taping Head	Bottom Taping Only
8000asb	Side	6.0	3.5	3.5	N/L	21.5	22.5	115V 60Hz 3.25A	No Air	Up to 40	100 (0.50)	3M™ AccuGlide™ NPH Taping Head	Bottom Taping Only
8000af	Side	6.0	4.75	4.5	30	21.5	28.5	115VAC 60Hz 3.8A 440W	2.5 SCFM @ 85 PSIG	Up to 40	100 (0.50)	2" 3M™ AccuGlide™ 3	Flap-Folding
8000af3			5.75									3" 3M™ AccuGlide™ 3	

Standard size capabilities are listed above. If additional sizes can be met, they are indicated by [Taping Head] or [Machine Configuration]. Changing the taping head or machine configuration will allow for enhanced box height range indicated in the chart above. Please refer to the Instructions and Parts List or 3M representative for more detail.

# 3M-Matic™ Random Case Sealers

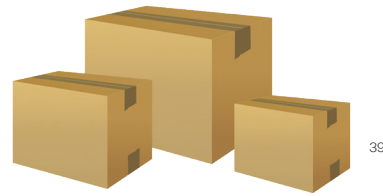

## Gain productivity with automatic height and width adjustments.

Adjusting automatically, these rugged units reliably and accurately seal runs of random size cartons for a variety of markets: food and beverage, medical devices, pharmaceuticals, electronics, retail, manufacturing and distribution centers. The 3M™ AccuGlide™ 2+ and 3 Taping Heads securely apply tape with low impact to protect even lightweight cases.

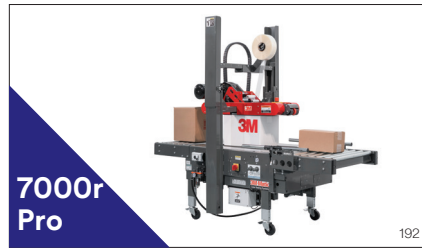

**3M-Matic™ Random Case Sealer 7000r Pro** is a semi-automatic random case sealer that automatically adjusts for case height and width and is capable of sealing 24 cases per minute, using tape widths from 36mm to 48mm wide.

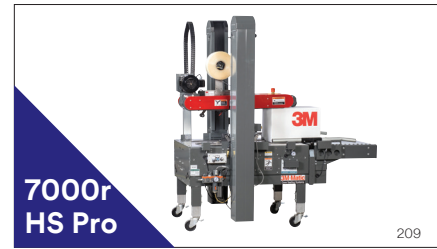

**3M-Matic™ Random Case Sealer 7000r High Speed Pro** is a random size case sealer designed to automatically adjust to a variety of box sizes. It can seal up to 28 different case sizes per minute.



**3M-Matic™ Case Sealer 8000r** is a semi-automatic, random case sealer that automatically adjusts for case height and width. Top and bottom seal at rates up to 20 cases per minute.



**3M-Matic™ Case Sealer 800rks** is a random king size case sealer that automatically adjusts for case height and width and is capable of sealing up to 10 cases per minute, using tape widths from 48mm to 72mm wide.

## Top and Bottom Belt Drive Systems

Machine	Drive System	Box Size Capacity (inches)						Power Requirements		Operating Rate (cs/min)	Belt-Drive Speed ft/min (m/s)	Taping Head	Comments
		Minimum			Maximum			Electrical	Air				
		L	W	H	L	W	H						
<b>7000r Pro</b>	Top and Bottom	6.0	6.5	4.5	N/L	26.5	26.0	115VAC 60Hz 3.8A 440W	3.75 SCFM @ 85 PSIG	Up to 24	100 (0,5)	2" 3M™ AccuGlide™ 3	Extended size capabilities are possible, please contact 3M
<b>7000r3 Pro</b>												3" 3M™ AccuGlide™ 3	
<b>7000r HS Pro</b>	Top and Bottom	7.0	7.0	3.5	N/L	26.0	27.0	115VAC 60Hz 9.5A 1140W	15 SCFM @ 90 PSIG	Up to 28	150 (0,76)	2" 3M™ AccuGlide™ V HSP Taping Head	
<b>7000r3 HS Pro</b>				2.7*								38.13*	

\*Requires special setup.

## Side Belt Drive Systems

Machine	Drive System	Box Size Capacity (inches)						Power Requirements		Operating Rate (cs/min)	Belt-Drive Speed ft/min (m/s)	Taping Head	Comments
		Minimum			Maximum			Electrical	Air				
		L	W	H	L	W	H						
<b>800rks</b>	Side	15.0	6.0	12.0	N/L	30.0	50.0	208/240VAC 3Ph 60Hz 6.6A 1500W	6.25 SCFM @ 85 PSIG	Up to 10	78 (0,4)	3" 3M™ AccuGlide™ 2+	Random King Size
<b>8000r</b>	Side	8.0	5.5	6.0	N/L	20.0	27.0	115V 60Hz 3.25A	6.2 SCFM @ 90 PSIG	Up to 20	100 (0,5)	3M™ AccuGlide™ V HSP Taping Head	Top and Bottom Sealing
<b>8000r3</b>												3M™ AccuGlide™ V HSP Taping Head	

Standard size capabilities are listed above. If additional sizes can be met, they are indicated by [Taping Head] or [Machine Configuration]. Changing the taping head or machine configuration will allow for enhanced box height range indicated in the chart above. Please refer to the Instructions and Parts List or 3M representative for more detail.

# 3M™ AccuGlide™ V HSP Taping Head

3M has a decades long history in case sealing and tape technology! We designed, engineered, and built our first 3M-Matic™ case sealer 55 years ago!

**Our new 3M™ AccuGlide™ V High Speed Taping Head combines the best attributes from all our 3M™ AccuGlide™ taping heads into one!**

**Speed**  
Tested at 150 feet per minute, with the ability to run at multiple speeds.

**Precision**  
Without compromising necessary tape adhesion, the 3M™ AccuGlide™ V HSP Taping Head will apply the precise pressure to adhere the tape without damaging the product in under-filled cases.

**Versatility**  
The narrow design allows the taping head to be quickly dropped into most case sealers and case erectors on the market.

**Durability**  
Reinforced key wear points and components for maximum durability. Rollers are more conformable for better wipe down. Side plates have been reinforced in key areas.

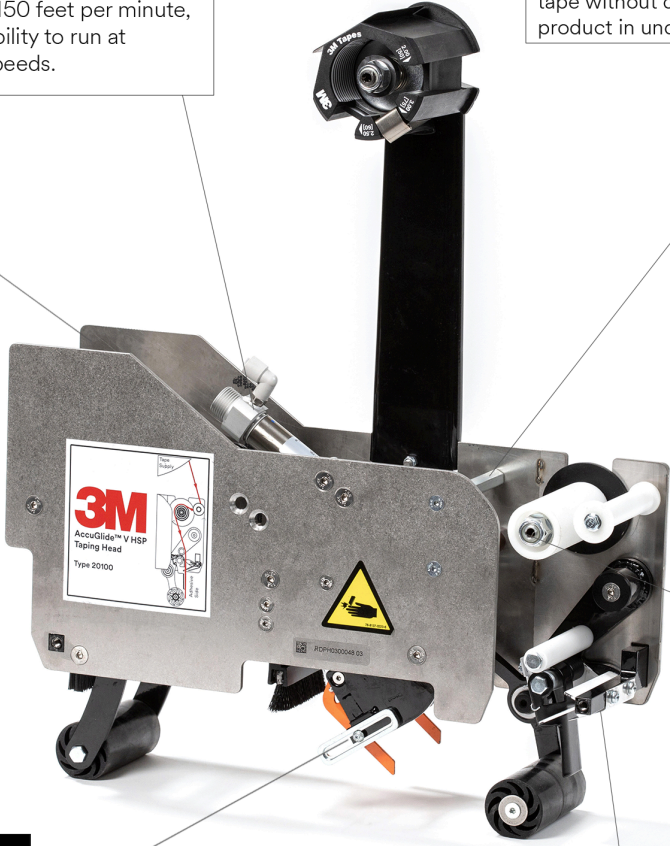

**Flexibility**  
Variable spring positioning, easy one-way tension roller and tape tension adjustments to accept varying corrugate and production environments.

**Tape Application**  
Full width blade for consistent tape cutting, a flap guide to prevent damage to the major flaps and better tape management for consistent tape leg lengths.

**Changeover**  
The tape threading path is open for faster changeovers.

# 3M™ AccuGlide™ Taping Head Technology

## 3M taping heads for easy and accurate case sealing.

3M™ AccuGlide™ Taping Heads are a curvilinear design that applies tape securely with low impact that helps protect even lightweight cartons and contents. Since the combination of box sealing tape and taping head determines carton closure performance, 3M is continually improving both to meet your requirements for productivity and reliability.



### 3M™ AccuGlide™ 2+

Speeds up to 78 ft. per minute.  
Stainless steel option available.



### 3M™ AccuGlide™ 3

Raising the speed limit to 100 ft. per minute for easy, consistent and accurate case sealing.



### 3M™ AccuGlide™ V

Speeds up to 78 ft. per minute.  
Stainless steel option available.



### 3M™ AccuGlide™ NPH+ Taping Head

Featuring a narrow profile head and up to 120 fpm taping speed, the AccuGlide NPH+ can help streamline your operations, maximize your productivity and improve your quality—no matter what brand of case sealer you own.



### 3M™ AccuGlide™ LHB

A low height box taping head that exerts minimum force on case and utilizes shorter tape legs.

## Customized 3M-Matic™ Equipment

### Built around your product needs.

A leading player in case sealing equipment, 3M realizes it's not one size fits all. We have a unique capability to take an existing 3M-Matic™ Case Sealer and customize it to securely seal your unique cartons. Some of our capabilities include width and height modifications, accommodating lighter or heavy weight boxes, and integrating unique tape set ups.



Side Taping

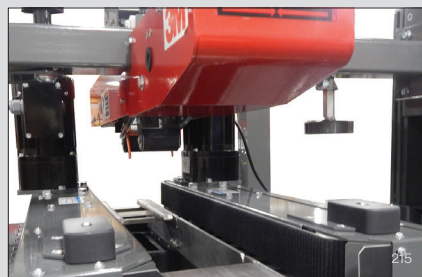

Box Lift for Low Height Cases



Wide Roll Taping



# Non-RSC Closure Solutions

**A range of solutions can help increase throughput while decreasing packaging costs.**

- Solutions for start-ups
- Automation for large companies

## 3M-Matic™ L-Clip Applicator S867 and S867II

To save cost and time, apply pre-fed 4.5-inch L-Clips of Scotch® Filament or Reinforced Strapping Tapes at up to 50 clips per minute to five panel fold, full overlap, telescoping, tuck fold and other non-standard packages. Dual head applies two clips simultaneously as close as 8 inches apart.

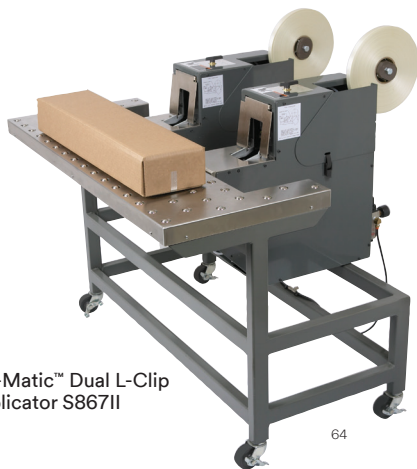

3M-Matic™ Dual L-Clip Applicator S867II

64

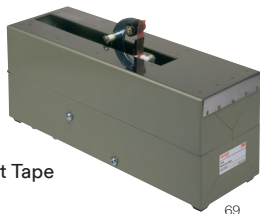

Scotch® Filament Tape Box Sealer S634

69



3M-Matic™ L-Clip Applicator S867 with optional U-Clip adapter.

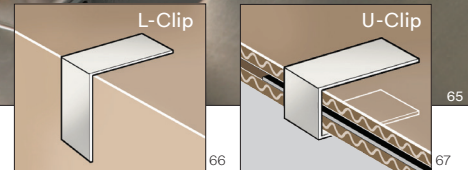

66

65

67

## Table Top L-Clip Applicators

Features	Box Sealer S634
Tape Type(s)	Filament Tape Light Duty Packaging Tape, Upper Scotch® Packaging Tape
Can L-Clip These Package Types	Corrugate
Applied Tape Length	4.5 inch (144mm)
Tape Width Options	0.375–1.5 inch (9.5–36mm)
Cutting Method	Serrated blade cuts tape as box passes L-Clip application mechanism

## Great L-Clip Closure Solution for Non-RSC Box Styles

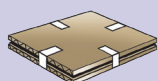

U-Clip Package

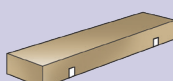

Telescoping Box

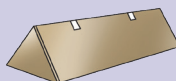

Custom Box

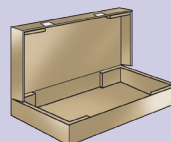

One Piece Box

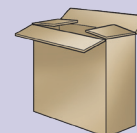

F.O.L.

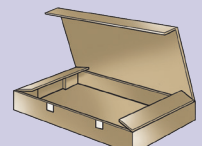

Five Panel Box

68

# 3M-Matic™ Case Sealers Replacement Parts and Accessories

## Genuine 3M Parts to maintain optimal performance of 3M-Matic™ Case Sealers.

Engineered for rugged duty with steel construction and epoxy coated surfaces, 3M-Matic™ Case Sealers may have parts that wear and need occasional replacement. 3M maintains stock of a full range of replacement parts from typical wear parts such as blades, belts, and springs to safety labels to bushings and cylinders. With over 5,000 stocked SKUs, replacement parts are available for prompt delivery to your location whether you are doing preventive maintenance or rebuilding a 3M-Matic™ Case Sealer after years of service.

Regular preventive maintenance of your equipment and quality parts are keys to performance of both newer case sealers or models that have been running for 30 years.

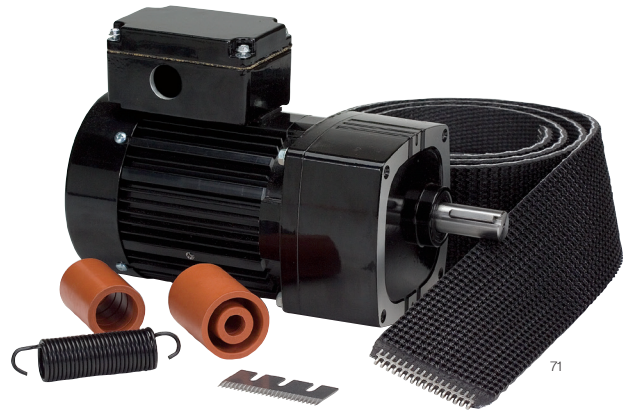

For replacement parts contact: 1-800-344-9883  
[store.combi.com/cspd](http://store.combi.com/cspd)

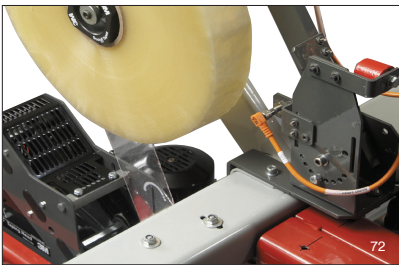

### Application Monitor

With top and bottom sensors, the case sealer mounted programmable logic controller alerts the operator when tape is not applied to the box or not cut, or when tape supply is low on the roll.



### Low Tape Indicator Light Kit

An option for 3M-Matic™ Case Sealers. Indicates when tape is getting low.



### 3-Flap Folder

For increased productivity, easily attached flap folder assists operator in folding the minor (front) and two major (side) flaps of RSCs before taping.

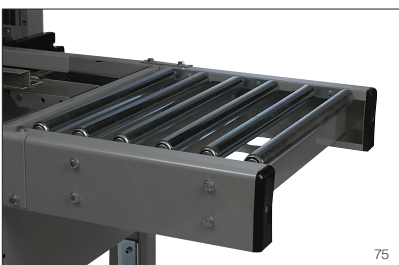

### Infeed/Exit Conveyor

Ball bearing steel rollers in a steel frame bolts to the 3M-Matic™ Case Sealer to provide a smooth transition in existing conveyor lines. Provides pack area surface at infeed. Available also in stainless steel.



### Box Hold Down Attachment

Holds RSCs on the optional infeed conveyor to free the operator's hands for case filling.



### Locking/Swivel Casters

When packaging operations need to be reconfigured or moved, 3M-Matic™ Case Sealers roll to the job on these heavy duty casters. Toe-operated lever locks case sealer in place.





# Scotch® and Tartan™ Manual Tape Dispensers

## Scotch® Box Sealing Tape Dispenser HR80/HR83

Portable, lightweight, easy to operate, hand-held dispenser with a retractable blade.



## Scotch® Low Noise Box Sealing Tape Dispenser H150/H153

A hand-held, roll-on, pistol-grip dispenser designed to reduce the noise of tape unwind.



## Tartan™ Box Sealing Hand Dispenser HR933

Tape dispenser with a retractable blade.

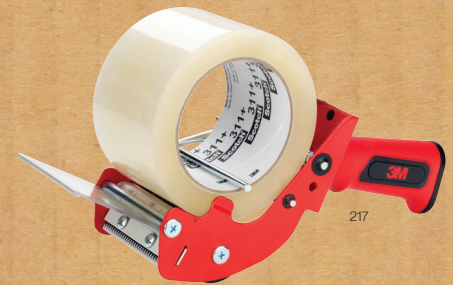

## Scotch® Heavy-Duty Dispensers

Manual heavy-duty dispensers for use with 3M™ Narrow Width Film Tapes.

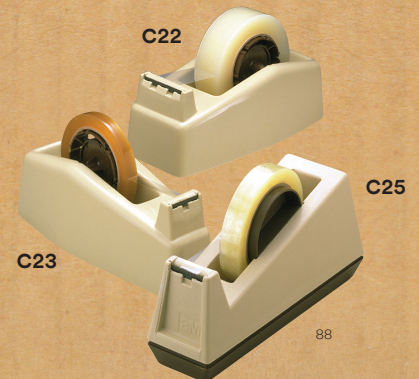

## Scotch® Box Sealing Tape Dispensers

Hand-held dispensers for use with specially formulated Scotch® Box Sealing Tapes.



## Specialty Scotch® Tape Dispensers

Hand-held dispensers for use with Scotch® High Strength Filament Tapes.

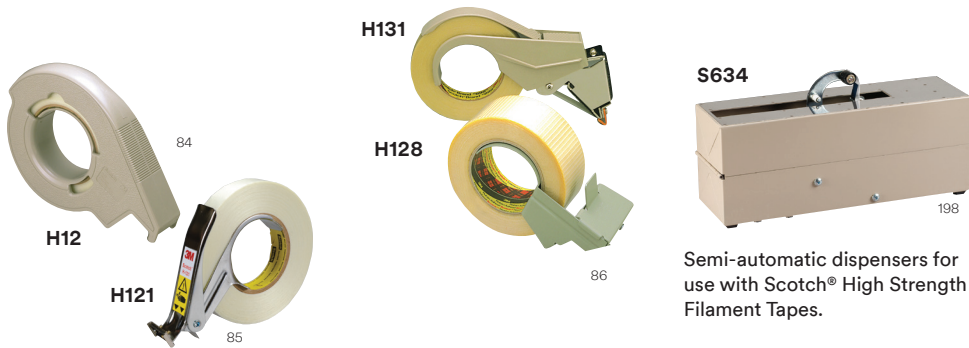

## Scotch® Bag Sealers

Applies tape in an adhesive-to-adhesive flag seal.

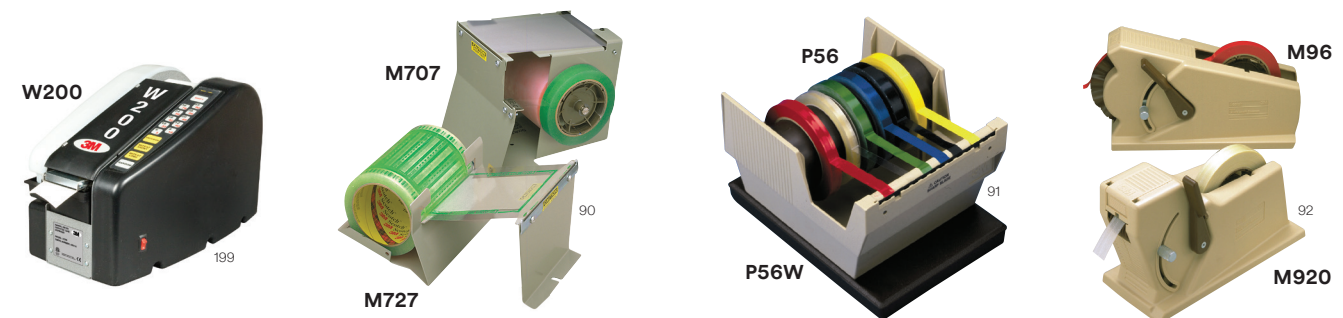

### 3M™ Electric Water Activated Tape Dispenser

Dispenser has a heated water reservoir that speeds tape activation. Dispenses a pre-set length of water-activated tape at the push of a button. (Manual version also available.)

### Scotch® Label Protection Dispensers

Tabletop and portable dispensers designed specifically for 3M™ Label Protection and Pouch Tapes.

### Scotch® Multi-Roll Dispenser

Dispenser for pull and tear of up to 6 inches total width of tapes. P56W offers weighted base. (P52/P52W also available for up to 2" total width tape.)

### Scotch® Definite Length Dispensers

Dispensers that deliver a uniform length of 3M™ Narrow Width Tape and Scotch® Filament Tapes every time quickly and easily. (M82 and M900 are also available for wider tape dispensing.)



# Scotch® and Tartan™ Manual Tape Dispensers

## Easy dispensing for manufacturing, office, commercial and retail jobs.

All Scotch® and Tartan™ Manual Tape Dispensers for box sealing tapes, filament tapes, film tapes, label protection tapes and pouch tapes are application-designed to meet the needs of the customer. Select from a variety of hand-held and heavy duty pull-and-tear table top dispensers.

Product	Product Description	Max Tape Width
<b>Hand-Held Box Sealing Tape Dispensers</b>		
H122	Durable plastic dispenser with built-in brake for precise seals	48mm
H123	Lightweight, compact metal tape dispenser	72mm
H128	Heavy-duty durable metal tape dispenser	48mm
H150	Tape dispenser designed to reduce the noise of tape unwind during application	48mm
H153	Tape dispenser designed to reduce the noise of tape unwind during application	72mm
H180	Portable and easy to operate pistol grip dispenser	48mm
H183	Portable and easy to operate pistol grip dispenser	72mm
H190	Pistol grip dispenser features pull apart design	48mm
H192	Ergonomical tape dispenser with hand brake	48mm
H320	Ultra-light, economical, plastic tape dispenser	48mm
HB902	Economical, compact, and lightweight tape dispenser	48mm
HB903	Economical pistol grip tape dispenser	48mm
HR80	Portable, lightweight, easy to operate, dispenser with a retractable blade	48mm
HR83	Portable, lightweight, easy to operate, dispenser with a retractable blade	72mm
HR933	Tape dispenser with a retractable blade	72mm
H12	Portable, plastic dispenser features a hand brake to add tension to the tape roll	24mm
H121	Durable, metal dispenser allows operator to add tension for a tighter tape application	24mm
H128	Heavy-duty, metal dispenser commonly used to dispense tapes 8959 and 890	48mm
H131	Quick and easy one hand method to apply, cut, and buff the tape closures	18mm
H133	Quick and easy one hand method to apply, cut, and buff the tape closures	18mm
HB901	Economical and portable tape dispenser	24mm
<b>Table Top Dispensers</b>		
C22	Weighted dispenser for easy pull and cut tape dispensing	2 in
C23	Weighted dispenser for easy pull and cut tape dispensing	1 in
C25	Weighted dispenser for easy pull and cut tape dispensing	1 in
HB900	Weighted, slip-proof base for quick and easy one-handed operation	1 in
M82	Definite length dispenser handles multiple rolls of tape commonly dispensed with filament and light duty tapes	96mm
M96	Definite length dispenser — dispenses tape in lengths of 3/4 inch to 5 inch per stroke	1 in
M900	Durable, metal construction dispenses a uniform length of packaging tape from 1-1/2 inch to 16 inch	3 in
M920	Definite length dispenser — dispenses tape in lengths of 1/2 inch to 4 inch per stroke	1 in
P52	Mainline tabletop manual pull and cut dispenser with multiple roll capacity	2 in
P52W	Mainline tabletop manual pull and cut dispenser with multiple roll capacity (comes with weighted base)	2 in
P56	Mainline tabletop manual pull and cut dispenser with multiple roll capacity	6 in
P56W	Mainline tabletop manual pull and cut dispenser with multiple roll capacity (comes with weighted base)	6 in
P448	Metal dispenser that handles multiple rolls for easy dispensing	8 in
S634	Semi-automatically applies L-Clip of tape to a box using filament or light duty tapes	18mm
W100	Manually dispenses pre-set length of water-activated tapes	3 in
W200	Electronic dispenser — dispenses a pre-set length of water-activated tape at the push of a button	3 in
<b>Specialty Tape Dispensers</b>		
M707	Heavy duty metal dispenser with auxiliary holder and cutter for 3/4-inch rolls of tape — commonly used with tapes 821 and 823	4 in
M727	Metal construction provides easy dispensing of pouch tapes 824, 827 and 829	5 in
M797	Metal construction provides easy dispensing of pouch tape 827	6 in
P400	Bag sealer — applies tape in an adhesive-to-adhesive — flag seal (includes bag trimmer)	3/4 in

# 3M Systems Tape Agreement

When you switch to Scotch® packaging tape and sign up for a 3M Systems Tape Agreement, you can receive no charge equipment, parts or taping heads for your case sealers.\*

\* Terms & Conditions apply

## Earn spare parts/tape heads

- Earn no-charge spare parts for your 3M-Matic™ Case Sealer when you purchase qualifying amounts of Scotch® Box Sealing Tape.
- Earn no-charge 3M™ AccuGlide™ Taping Heads for your 3M-Matic™ Case Sealer when you purchase qualifying amounts of Scotch® Box Sealing Tape.

## Earn credit

- Earn credits towards a new 3M-Matic™ Case Sealer.

To learn more about the  
**3M Systems Tape Agreement,**  
visit: [3M.com/STA](https://www.3m.com/STA).



Contact your 3M packaging specialists for more details about these great offers.



# Right tape. Right system. Right partner.

## Take your packaging process to the next level.

Purchase qualifying amounts of Scotch® Box Sealing Tape and receive no charge equipment, parts or taping heads for your case sealers.

Core Products (371, 311+)			Premium Products (313, 315, 355, 371+, 373+, 375+)		
Offer type	Product	No Charge Quantity	Offer type	Product	No Charge Quantity
<b>When you buy 1 pallet</b>			<b>When you buy 1 pallet</b>		
3M-Matic™ Credit	\$250 USD / \$330 CAD Credit	1	3M-Matic™ Credit	\$1,000 USD / \$1,320 CAD Credit	1
Hand Dispensers	Case of Hand Dispensers	1	Hand Dispensers	Case of Hand Dispensers	2
Spare Parts Kit	3M™ AccuGlide™ or 3M-Matic™ SPK	1	Spare Parts Kit	3M™ AccuGlide™ or 3M-Matic™ SPK	1
<b>When you buy 2 pallets</b>			<b>When you buy 2 pallets</b>		
Taping Head	3M™ AccuGlide™ 2	1	Taping Head	3M™ AccuGlide™ 2	1
	3M™ AccuGlide™ 2+	1		3M™ AccuGlide™ 2+	1
	3M™ AccuGlide™ 3	1		3M™ AccuGlide™ 3	1
	3M™ AccuGlide™ NPH	1		3M™ AccuGlide™ 2+ SST	1
3M™ AccuGlide™ NPH+	1	3M™ AccuGlide™ NPH		1	
				3M™ AccuGlide™ NPH+	1
				3M™ AccuGlide™ NPH SST	1
<b>When you buy 3 pallets</b>			<b>When you buy 2 pallets</b>		
Specialty Taping Head	3M™ AccuGlide™ 2+ SST	1	Specialty Taping Head	3M™ AccuGlide™ 6W	1
	3M™ AccuGlide™ V HSP	1		3M™ AccuGlide™ V HSP	1
	3M™ AccuGlide™ NPH SST	1		3M™ AccuGlide™ HST (Black / Blue)	1
<b>When you buy 4 pallets</b>			<b>When you buy 12 pallets</b>		
Specialty Taping Head	3M™ AccuGlide™ 6W	1	Equipment (one machine per customer per calendar year)	2000a	1
	3M™ AccuGlide™ HST (Black / Blue)	1		7000a	1
<b>When you buy 24 pallets</b>				8000a	1
Equipment (one machine per customer per calendar year)	2000a	1		8000ab	
	7000a	1		8000asb	
	8000a	1		S867	1
	8000ab	1		S867-II	1
	8000asb	1	<b>When you buy 18 pallets</b>		
	S867	1	Equipment (one machine per customer per calendar year)	8000r	1
S867-II	1	7000r		1	
		8000af		1	
<b>When you buy 32 pallets</b>					
Equipment (one machine per customer per calendar year)	8000r	1			
	7000r	1			
	8000af	1			



# Box Sealing Tapes

Delivering quality with tapes that keep production lines moving with less interruption and ensure packages are sealed on arrival.



# The full job of a package is containment, protection and communication.

## Technology that really delivers.

- Seal cartons reliably without the mess, dwell time and equipment maintenance of hot melt adhesive
- Two choices of pressure sensitive adhesive, each with a different combination of properties
- Backing choices for specific performance properties

3M eliminates 99% of organic solvents in production of Scotch® Box Sealing Tape.

Our Scotch® Recycled Corrugate Tape 3073 is made with an adhesive that contains over 10% bio-based content. All recycled corrugate tapes use recycled materials in the core to help with your sustainability goals.

Visit [3M.com/sustainability](https://www.3m.com/sustainability) for more goals.



**Caring for the environment now and for the future.**

## Scotch® Box Sealing Tapes solve common package sealing problems:



Problem: Tabbing

**Solution:** Easy unwind and high initial adhesion of Scotch® Box Sealing Tapes reduce tabbing downtime and rework.



Problem: Tape popping

**Solution:** Initial adhesion and holding power of Scotch® Box Sealing Tapes ensure a secure sealing throughout a supply chain.

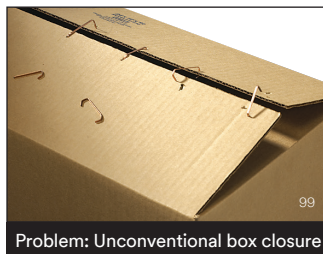

Problem: Unconventional box closure

**Solution:** Scotch® Box Sealing Tapes close securely without the holes, waste, appearance, sharp points and disposal of staples.

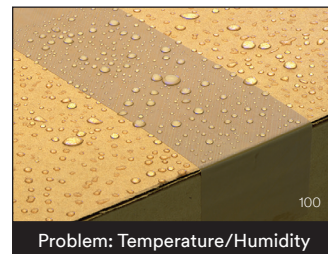

Problem: Temperature/Humidity

**Solution:** Scotch® Box Sealing Tapes resist moisture encountered in storage and shipping through the supply chain.

## Tape Backing and Adhesive Selection Guide

<b>Step 1</b> Select Tape Backing	<b>Polyester</b>	<ul style="list-style-type: none"> <li>• Strongest backing</li> <li>• Excellent abrasion resistance</li> <li>• Moisture and chemical resistance</li> </ul>	<ul style="list-style-type: none"> <li>• Highest temperature resistance</li> <li>• Transparency</li> </ul>
	<b>Polypropylene</b>	<ul style="list-style-type: none"> <li>• Strong backing</li> <li>• Good abrasion resistance</li> <li>• Good conformability</li> </ul>	<ul style="list-style-type: none"> <li>• Most economical</li> <li>• Transparency</li> </ul>
<b>Step 2</b> Select Tape Adhesive	<b>Synthetic Rubber</b>	<ul style="list-style-type: none"> <li>• Excellent holding power</li> <li>• Good initial adhesion above 40°F</li> <li>• Meets ASTM D-5486 government specification</li> </ul>	
	<b>Acrylic</b>	<ul style="list-style-type: none"> <li>• Excellent initial adhesion over a broad temperature range</li> <li>• Extremely long performance life</li> <li>• High UV and chemical tolerance</li> </ul>	

Delivering service and support to help you select the right 3M product for your application. On-site consultation with experienced 3M engineers and sales specialists are standing by to help.

# Box Sealing Tape Selector

Use this selector to help determine a box sealing tape that meets your packaging needs. **The suggestions provided by this method must be confirmed by testing.** Additional packaging and shipping factors should also be considered.

Circle the point value that best describes your operations		
	Point Value	Points
<b>1. How much does the filled box weigh?</b>		
a. 10 pounds	10	
b. 20 pounds	20	
c. 30 pounds	25	
d. 40 pounds	30	
e. 50 pounds	35	
f. 70 pounds	45	
g. 80 pounds	50	
h. 100 pounds	60	
<b>2. What is the carton burst/ECT test?</b>		
a. 150 SW/26	5	
b. 175 SW/29	10	
c. 200 SW/32	15	
d. 250 SW/40	20	
e. 275 SW/44	25	
f. 350 SW/55	30	
g. 200 DW/42	35	
h. 275 DW/48	40	
i. 350 DW/51	45	
<b>3. What is the value of contents?</b>		
a. <\$100	10	
b. \$100-\$1000	25	
c. >\$1000	40	
<b>4. What is the method of shipment?</b>		
a. Palletized and unitized	5	
b. Palletized but not unitized	15	
c. Single	30	
<b>5. Type of carrier</b>		
a. Company truck	5	
b. Commercial transport/LTL	15	
c. UPS/USPS/FEDEX	30	
<b>Total Points</b>		

Choose an effective closure...choose 3M		
205		
195		72mm
180		
165		72mm
150		
135		48mm
120		48mm
105		
90		42mm
75	72mm	
60		36mm
45	48mm	
35	42mm	36mm
	36mm	
	<b>Scotch® Box Sealing Tape Recommended for Testing</b>	
<b>Your Total Points</b>	<b>3071</b>	<b>373</b>
	<b>371</b>	<b>313</b>
	<b>371+</b>	<b>3073</b>
	<b>311+</b>	<b>355</b>

These suggestions are based on experience, but there are factors which could alter the overall performance. **For example:**

Cartons with center seam gap greater than 3/4" or over packed/under packed cartons should be tested with 3" (72mm) wide tape

Hard-to-stick surfaces and Recycled Corrugate Boxes, test Scotch® Recycled Corrugate Tape 371+, 3071 and 3073

Box sealing tapes are available custom printed and with standard security messages

Applications when tape is applied under 40°F, test Scotch® Box Sealing Tape 311+, 373+ and 375+

If your package is unusual in size, shape, or load, try the 3M Technical Service Request (TSR) Program. Using the 3M TSR Program, a 3M representative will work with you on initial testing of a Scotch® Box Sealing Tape. One or two best options will be identified then a sample of your substrate is brought to the 3M Laboratories and tested for stress or other factors the product will encounter. The 3M test results will help you select the best box sealing tape for your manufacturing process and customer needs.





# Scotch® and Tartan™ Box Sealing Tapes

**Dependability for eCommerce, fulfillment, food and beverage, pharmaceuticals, electronics and more.**

With choices of polyester or polypropylene backings and synthetic rubber or acrylic adhesives, you have dependability for a wide variety of box types, sizes, contents, handling situations and storage conditions.

- Reliability even with the stresses of over packed or under packed boxes
- Quick, easy application by hand, manual dispensers or 3M-Matic™ Case Sealers
- Choice of lengths, widths, backings, adhesives and colors to meet specific needs

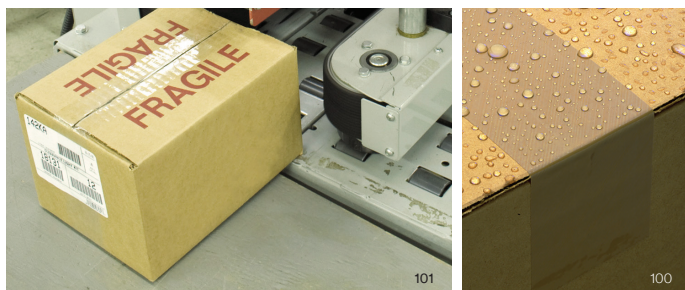

Consistent quality of Scotch® Box Sealing Tapes means fewer interruptions on your packaging line.

Scotch® Box Sealing Tapes with polyester backing and synthetic rubber adhesive resist the moisture in storage and shipping.



Product	Tape Structure (Backing/Adhesive)	Tape Class	Adhesion to Steel oz/in (N/100mm)	Tensile Strength lbs/in (N/100mm)	Elongation at Break (%)	Backing Thickness mils (mm)	Total Thickness mils (mm)	Available Colors/Comments
<b>ASTM Test Method</b>			<b>D-3330</b>	<b>D-3759</b>	<b>D-3759</b>	<b>D-3652</b>	<b>D-3652</b>	
						220		
<b>Scotch® Box Sealing Tapes</b>								
311+	Polypropylene/Acrylic	Medium Duty	38 (42)	25 (438)	125	1.1 (0.028)	2.05 (0.052)	Clear, Tan
371+	Polypropylene/Synthetic Rubber	Medium Duty	45 (49.3)	22 (385)	160	1.2 (0.030)	2.1 (0.053)	Clear or Custom Printed
373+		Heavy Duty	50 (54.9)	30 (525)	160	1.6 (0.041)	2.5 (0.060)	Clear or Custom Printed: Adhesive contains 10% renewable components
375+		Ultra-Heavy Duty	55 (60)	35 (613)	160	2.0 (0.051)	3.1 (0.079)	Clear, Tan or Custom Printed
<b>Scotch® Performance Grade Box Sealing Tapes</b>								
371	Polypropylene/Synthetic Rubber	Medium Duty	40 (44)	22 (385)	160	1.2 (0.030)	1.8 (0.046)	Clear, Tan, Blue, Green, Orange, Red, White, Yellow or Custom Printed
373		Heavy Duty	55 (55)	30 (525)	160	1.6 (0.041)	2.5 (0.064)	Clear, Tan, Blue, Green, Orange, Red, White, Yellow or Custom Printed
375		Ultra-Heavy Duty	55 (60)	35 (613)	160	2.0 (0.051)	3.1 (0.079)	Clear, Tan or Custom Printed
<b>Scotch® Polyester Box Sealing tapes</b>								
353	Polypropylene/Synthetic Rubber	Heavy Duty	45 (49)	25 (438)	110	1.0 (0.025)	1.9 (0.048)	Clear, Tan or Custom Printed
355		Ultra-Heavy Duty	78 (85)	67 (1174)	130	2.0 (0.051)	3.43 (0.087)	Clear, Tan or Custom Printed
351		Heavy Duty with Government Spec	78 (85)	67 (1174)	130	2.0 (0.051)	3.43 (0.087)	Clear, Tan or Custom Printed
<b>Scotch® Utility Grade Box Sealing Tapes</b>								
313	Polypropylene/Acrylic	Heavy Duty	32 (35)	35 (613)	125	1.6 (0.041)	2.55 (0.065)	Clear
315		Heavy Duty	38 (41.5)	23 (403)	200	2.3 (0.058)	3.5 (0.089)	Clear
<b>Tartan™ Box Sealing Tapes</b>								
302	Polypropylene/Acrylic	Medium Duty	14 (15)	18 (309)	110	1.0 (0.025)	1.7 (0.042)	Clear
305		Medium Duty	16 (18)	18 (309)	110	1.0 (0.025)	1.8 (0.045)	Clear

Note: This technical information and data should be considered representative or typical only and should not be used for specification purposes.

# Scotch® Plus+ Series Tapes



Adheres to substrates containing up to 100 % recycled corrugate



High tack, performance grade and fast grab



Added strength and value allows use of a single strip to confidently seal boxes



Compatible with 3M-Matic™ Case sealing equipment

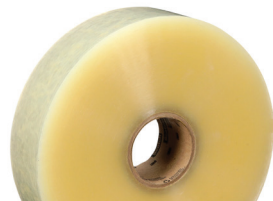

**311+** Pallet Shipment

Medium Duty Heavy Duty Ultra-Heavy Duty

Engineered for everyday use and to perform when applied at cold temperatures

- Palletized shipments
- Performance-grade acrylic
- Everyday use
- Great value for the dollar

**371+** Pallet Shipment

Medium Duty Heavy Duty Ultra-Heavy Duty

Designed to seal quickly and securely

- Palletized shipments
- Quick stick hot melt adhesive
- Available in custom printing

**373+** Private Single Parcel Carrier

Medium Duty Heavy Duty Ultra-Heavy Duty

Developed to withstand the stresses over and under-packed of boxes

- High value palletized shipments
- Quick stick hot melt adhesive
- Box weight up to 80lbs\*
- Private single-parcel carrier
- Available in custom printing

**375+** 3-Party Carrier (Land, Sea, Air)

Medium Duty Heavy Duty Ultra-Heavy Duty

Created for ultimate strength in the toughest commutes

- Tough commute shipments
- Quick stick hot melt adhesive
- Box weight up to 100lbs\*
- Third-party carrier
- Available in custom printing



## High Tack Box Sealing Tapes Comparison Guide

Product	Tape Structure (Backing/Adhesive)	Tape Class	Adhesion to Steel oz/in (N/100mm)	Tensile Strength lbs/in (N/100mm)	Elongation at Break (%)	Backing Thickness mills (mm)	Total Thickness mills (mm)	Available Colors/Comments	Custom Printed	Underfill Box	Overfill Box	Recycled Corrugate	Rough Commutes	Compatible with 3M-Matic™ Equipment
ASTM Test Method			D-3330	D-3759	D-3759	D-3652	D-3652							
<b>311+</b>	Polypropylene/Acrylic	Medium Duty	38 (42)	25 (438)	125	1.1 (0.028)	2.05 (0.052)	Clear, Tan				●		●
<b>371+</b>	Polypropylene/Synthetic Rubber	Medium Duty	45 (49.3)	22 (385)	160	1.2 (0.030)	2.1 (0.053)	Clear, Tan or Custom Printed	●	●	●			●
<b>373+</b>		Heavy Duty	50 (54.9)	30 (525)	160	1.6 (0.041)	2.5 (0.060)	Clear, Tan or Custom Printed; made with 10% bio-based adhesive	●	●	●	●	●	●
<b>375+</b>		Ultra Heavy Duty	55 (60)	35 (613)	160	2.0 (0.051)	3.1 (0.079)	Clear, Tan or Custom Printed	●	●	●	●	●	●

Note: This technical information and data should be considered representative or typical only and should not be used for specification purposes.



# Scotch® Custom Printed Box Sealing Tapes

## Let them know exactly who the package came from.

With every delivery, Scotch® Custom Printed Box Sealing Tape helps you differentiate your packages from the competitors. Whether you include your logo, tagline or other promotional messaging, your package will surely get noticed.

- Printed message won't rub off during transit
- Can be used to print handing instructions or labeling, replacing the need to carry large inventories of various printed cartons
- Adds security by discouraging tampering



Scotch® Box Sealing Tapes can be custom printed in up to 10 colors. Choose from the entire library of Pantone® Inks to match your logo brand or theme.

- Easily conforms around edges ✓
- Strong seal on rough surfaces ✓
- Holds through wide temperature variations ✓
- Resists moisture in storage and shipping ✓
- Resists nicks and abrasions ✓
- Ideal for food and beverage ✓
- Quick, easy application ✓

Product	Tape Structure (Backing/Adhesive)	Tape Class	Adhesion to Steel oz/in (N/100mm)	Tensile Strength lbs/in (N/100mm)	Elongation at Break (%)	Backing Thickness mils (mm)	Total Thickness mils (mm)	Available Colors/Comments
ASTM Test Method			D-3330	D-3759	D-3759	D-3652	D-3652	
371+CP	Polypropylene/ Synthetic Rubber	Medium Duty	45 (49.3)	22 (385)	160	1.2 (0.030)	2.1 (0.053)	Clear or Custom Printed
373+CP		Heavy Duty	50 (54.9)	30 (525)	160	1.6 (0.041)	2.5 (0.060)	Clear, Tan or Custom Printed: made with 10% bio-based adhesive
375+CP		Ultra-Heavy Duty	55 (60)	35 (613)	160	2.0 (0.051)	3.1 (0.079)	Clear, Tan or Custom Printed
371CP	Polypropylene/ Synthetic Rubber	Medium Duty	40 (44)	22 (385)	160	1.2 (0.030)	1.8 (0.046)	Clear, Tan, Blue, Green, Orange, Red, White, Yellow or Custom Printed
373CP								
3715CP								
353CP	Polyester/ Synthetic Rubber	Heavy Duty	45 (483)	25 (438)	110	1.1 (0.025)	1.9 (0.048)	Clear, Tan
355CP		Ultra-Heavy Duty	78 (85)	67 (1174)	130	2.0 (0.051)	3.43 (0.087)	Clear, Tan or Custom Printed

PANTONE® is the property of Pantone LLC.

**Note:** This technical information and data should be considered representative or typical only and should not be used for specification purposes.

# Scotch® Cold Temperature Tape

## Extreme performance even in cold temperatures.

- Adheres to a variety of surfaces, including on corrugated boxes with over 70% recycled content.
- Can be applied at freezer and refrigeration temperatures of 20°F to 50°F (-6.6°C to 10°C).
- Once applied, performs well on fiberboard boxes subjected to temperatures below 32°F (0°C).
- Quick, easy application by hand, manual dispensers or 3M-Matic™ Case Sealers.
- Moistened adhesive interacts with porous surfaces to form a powerful, secure bond
- Tape forms a tamper-evident seal that shreds if an attempt is made to pull it off before delivery
- Paper construction is easy to handle, making it ideal for hand applications
- Boxes are sealed secure, yet easy to open without cutting tools
- Coreless rolls reduce waste and simplify roll changes

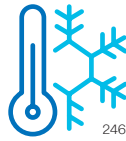

246



226



102

For box packing, sealing and storage below 40°F, Scotch® Box Sealing Tape 311+ seal with a rubber adhesive modified for reliability in the cold.

Product	Tape Structure (Backing/Adhesive)	Tape Class	Adhesion to Steel oz/in (N/100mm)	Tensile Strength lbs/in (N/100mm)	Elongation at Break (%)	Backing Thickness mils (mm)	Total Thickness mils (mm)	Available Colors/Comments
<b>ASTM Test Method</b>			<b>D-3330</b>	<b>D-3759</b>	<b>D-3759</b>	<b>D-3652</b>	<b>D-3652</b>	
<b>311+</b>	Polypropylene/Acrylic	Medium Duty	38 (42)	25 (438)	125	1.1 (0.028)	2.05 (0.052)	Clear

103

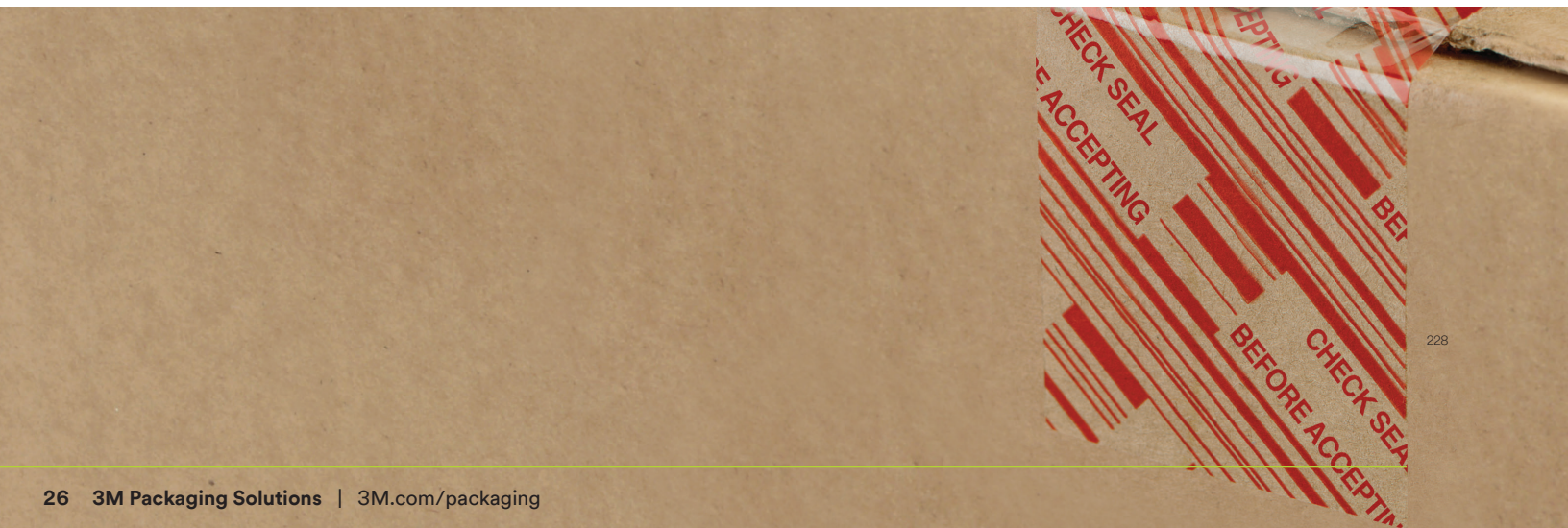

228



# 3M™ Water Activated Tapes



**Simplify your packing operations with a proven solution.**

3M™ Water Activated Tapes are an easy, economical answer to a wide variety of basic carton sealing challenges.

Product	Tape Structure (Backing/Adhesive)	Basis Weight	Caliper (mils)	Tensile Strength (lbs / in)	Tear Strength (grams)	Available Colors/Comments
<b>ASTM Test Method</b>		<b>D-646</b>	<b>D-645</b>	<b>D-5803</b>	<b>D-1922</b>	
<b>Water Activated Tapes</b>						
6141	Paper backing/gummed modified cornstarch based adhesive	35	3.5	30	72	Kraft (Tan) or Custom Printed
6142		60	5.5	44	125	
6143		90	7.5	58	200	
6144	Paper backing with filament reinforcement/gummed modified cornstarch based adhesive	23 / 23	4.9	45-50	N/A	Kraft (Tan) or Custom Printed
6145		23 / 23 (Kraft) 30 / 23 (White)	5.0 (Kraft) 7.3 (White)	52-57	N/A	Kraft (Tan), White or Custom Printed
6146		30 / 23	6.5	60-65	N/A	Kraft (Tan) or Custom Printed
6147		23 / 23 (Kraft)	8.5	60-65	N/A	Kraft (Tan) or Custom Printed

Product	Tape Structure (Backing/Adhesive)	Tape Class	Adhesion to Steel oz/in (N/100mm)	Tensile Strength lbs/in (N/100mm)	Elongation at Break (%)	Backing Thickness mils (mm)	Total Thickness mils (mm)	Available Colors/Comments
<b>ASTM Test Method</b>			<b>D-3330</b>	<b>D-3759</b>	<b>D-3759</b>	<b>D-3652</b>	<b>D-3652</b>	
<b>Security Tapes</b>								
373+ Printed	Polypropylene/ Synthetic Rubber	Heavy Duty	50 (55)	30 (525)	160	1.6 (0.041)	2.5 (0.064)	Tan with Red Type: IF SEAL IS BROKEN CHECK CONTENTS BEFORE ACCEPTING Adhesive contains 10% renewable components
3771		Medium Duty	40 (44)	22 (385)	160	1.2 (0.030)	1.8 (0.046)	White with Red Type: IF SEAL IS BROKEN CHECK CONTENTS BEFORE ACCEPTING
3772			40 (44)	22 (385)	160	1.2 (0.030)	1.8 (0.046)	White with Red Type: FRAGILE HANDLE WITH CARE
3775			40 (44)	22 (385)	160	1.2 (0.030)	1.8 (0.046)	White with Red Type: MIXED MERCHANDISE ENCLOSED
3779			40 (44)	22 (385)	160	1.2 (0.030)	1.8 (0.046)	Clear with Red Type: CHECK SEAL BEFORE ACCEPTING
3199	Polypropylene/ Acrylic		22 (24)	25 (701)	125	1.1 (0.028)	2.05 (0.052)	Clear with Red Type: CHECK SEAL BEFORE ACCEPTING

## Scotch® Security Tapes

**Deter package tampering.**

Scotch® Security Box Sealing Tapes are ideal for sealing packages and securing loads with high value contents. Printed messages communicate the need for careful package inspection prior to acceptance and reduce theft during the shipping process. Available with a variety of pre-printed messages.



**Note:** This technical information and data should be considered representative or typical only and should not be used for specification purposes.

# Light Duty Packaging Tapes

**Versatility with choices of film backings and adhesives for application success.**

## Typical Light Duty Applications

- Garment bundling
- Plastic bag closure
- Party tray closure
- Small box closure
- Document envelope closure
- Inner pack box closure



## Variety of Surfaces

- Fabrics
- Molded plastics
- Metals
- Clay-coated paperboard
- Corrugated
- Vinyl and films



231

### Scotch® Light Duty Packaging Tape 640+ Clean Removal

UPVC backing with clean removal acrylic adhesive for a wide variety of fabric finishes and treatments, including for tabbing shirts and underwear.



232

### Scotch® Light Duty Packaging Tape 605 Cold Temperature

Polypropylene backing with acrylic adhesive for cold temperature applications, such as closing a plastic tray lid.



233

### Scotch® Light Duty Packaging Tape 600 High Clarity

A transparent film tape designed for a variety of general industrial applications. The UPVC backing material is moisture, chemical and UV resistant. The acrylic adhesive provide clean removability from a wide variety of surfaces.

### Scotch® Color Coding Tape 690

UPVC backing with natural rubber adhesive for sealing and color coding.



234



# Light Duty Packaging Tapes

Product	Color	Backing Material	Backing Thickness mils (mm)	Total Thickness mils (mm)	Tensile Strength lb/in (N/100mm)	Adhesive Type	Adhesion to Steel oz/in (N/100mm)	Elongation (%)	Typical Use	Comments
<b>Light Duty Packaging Tapes</b>										
600	Clear	UPVC	1.5 (0.038)	2.3 (0.058)	28 (490)	Acrylic	32 (35)	45	L-Clip closure, attaching, tabbing and holding	Excellent handling, high clarity and long aging
605	Clear	Polypropylene	1.6 (0.041)	2.5 (0.064)	22 (385)	Acrylic	27 (30)	57	Cold temperature packaging	Cold temperature applications; Complies to FDA Regulations for indirect food contact
640	Clear	UPVC	1.2 (0.030)	1.9 (0.048)	32 (560)	Acrylic	22 (25)	65	Tabbing and holding of apparel	Clean removal from wide variety of fabrics and substrates
640+	Clear	UPVC	1.2 (0.030)	1.9 (0.048)	32 (560)	Acrylic	22 (25)	65	Tabbing and holding of apparel	Clean removal from wide variety of fabrics and substrates
681	Clear	UPVC	1.5 (0.038)	2.4 (0.061)	25 (438)	Natural Rubber	40 (44)	35	Sealing	Resists moisture and chemicals; Heat shrinkable; Complies with US FDA 21 CFR 175.105 for indirect food contact
690	Black, Blue, Green, Red, Yellow, White	UPVC	1.5 (0.038)	2.3 (0.058)	35 (613)	Natural Rubber	30 (33)	45	Color coding	Resists moisture and chemicals; Heat shrinkable
856	Transparent	Polyester	1.0 (0.025)	2.0 (0.051)	25 (438)	Acrylic	20 (22)	90	Tough backing for good tear resistance	Tough backing for good tear resistance
5910	Clear	Polypropylene	1.2 (0.030)	2.0 (0.051)	18 (315)	Acrylic	16 (17)	90	Utility grade for light duty packaging	Conforms easily
<b>Fingerprint Lifting Tape</b>										
8004	Clear	Polypropylene	1.4 (0.036)	2.0 (0.051)	18 (315)	Acrylic	16 (17)	90	Ultra clear tape; Handles easily	Lift and preserve physical evidence such as fingerprints

## Technologies matched to the applications.

### Choice of Backings

- UPVC for transparency plus moisture, chemical and UV resistance; non-staining and heat-shrinkable
- Polypropylene for transparency plus conformability and flexibility
- Cellophane for heat resistance
- Polyester for strength and abrasion resistance

### Choice of Adhesives

- Acrylic for long aging and UV resistance
- Rubber for high initial bond strength and adhesion to wide variety of materials including hard-to-bond plastics

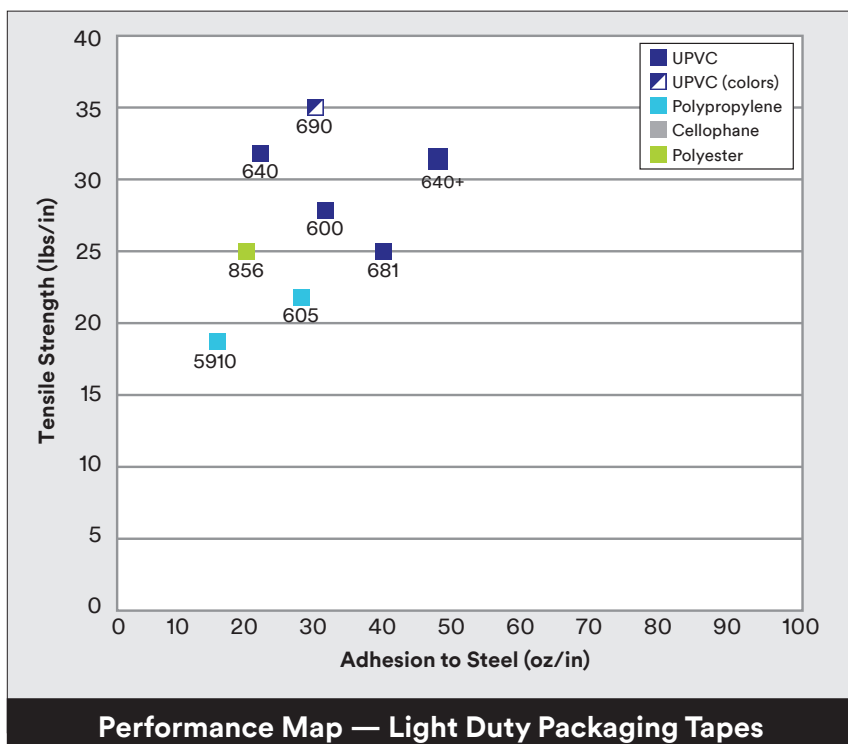

**Note:** This technical information and data should be considered representative or typical only and should not be used for specification purposes.



# Custom Packaging Solutions



# 3M™ Carry Handles

## Applied at Retail Checkout

### Convenience for your customer.

- Pre-cut padded carry handles for easy application
- Quickly and easily transform bulky purchases into travel-friendly packages
- Custom print! Put your BRAND in consumer's hands
- Custom size to meet your store profile
- Great alternative to large retail shopping bag. Save a bag...get a handle
- Reduce single-use plastic and plastic waste by up to 74%

\*Based on the weight of a large plastic bag of 17.5 grams vs. 3M™ Carry Handle weight of 4.5 grams.



## Pre-Applied By Manufacturer

### Give your products a lift.

- Differentiate your on-shelf appeal — customers will associate convenience with your brand
- Easily combine two stand up pouches for a unique duo-pouch solution
- Printed handles communicate — drive brand awareness, augment or replace other package information
- Convenience: Promo packs and up-sized SKUs can be easily carried from store to car or bus to home or office
- Ask your 3M Packaging Specialist for details on automated application equipment



Range of carry handle options — pre-cut (hand applied) or in-line pre-laminated (machine applied)

# 3M™ Carry Handles

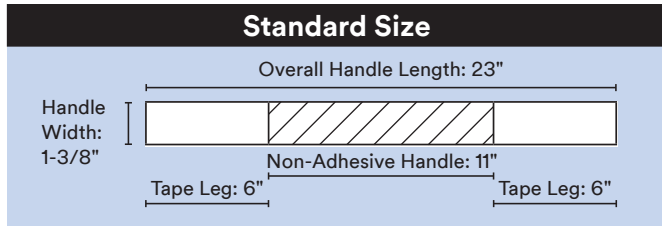

**Weight**

carry handle **4.5g**

large retail plastic bag **17.5g**

Reduce plastic waste by **74%**



## Pre-cut padded carry handles for hand application.

Product	Weight Holding Capacity (lbs)	Tape Material	Total Thickness mils (mm)	Tensile Strength lb/in (N/100mm)	Adhesive Type	Adhesion oz/in (N/100mm)	Pads per Case	Handles per Case	Handle (W x L)	Tape Leg Length
ASTM Test Method			D-3652	D-3759	D-3330					
8310	10	Polypropylene	3.1 (0.079)	35 (613)	Synthetic Rubber	55 (60)	110	2750	1" x 17"	3"
8315	15	Polypropylene	3.1 (0.079)	35 (613)	Synthetic Rubber	55 (60)	80	2000	1-3/8" x 23"	6"
8320	20	Polyester	3.5 (0.089)	67 (1174)	Synthetic Rubber	78 (85)	110	2750	1" x 17"	3"
8330	30	Polyester	3.5 (0.089)	67 (1174)	Synthetic Rubber	78 (85)	80	2000	1-3/8" x 23"	6"
8350	50	Filament Tape	7.7 (0.196)	270 (4728)	Synthetic Rubber	80 (88)	80	2000	1-3/8" x 23"	6"

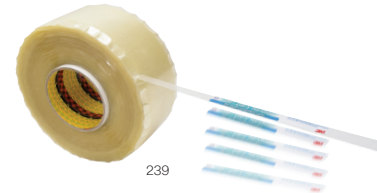

## In-line carry handles for automated application. Enables quick change over of marketing message.

Product	Weight Holding Capacity (lbs)	Tape Material	Adhesive Type	Adhesion oz/in (N/100mm)	Tensile Strength lb/in (N/100mm)	Total Thickness mils (mm)	Roll Type	Roll (W x L)	Core Dia.
8346	20	Polyester	Natural Rubber	28 (30)	45 (786)	2.9 (0.073)	Level- wound	1" x 5470 yd	6"
8346HP	20	Polyester	Synthetic Rubber	52 (57.0)	57 (996)	3.4 (0.086)	Level- wound	1" x 5470 yd	6"
9009HP	20	Polypropylene	Synthetic Rubber	50 (55)	103 (1800)	2.55 (0.065)	Level- wound	1" x 7108 yd	6"



## Pre-laminated carry handles for automated application. Perfect for long runs with limited change overs.

Product	Weight Holding Capacity (lbs)	Handle Material	Adhesive Type/Backing	Adhesion oz/in (N/100mm)	Tensile Strength lb/in (N/100mm)	Total Thickness mils (mm)	Roll Size/Format	Core Dia.	Suggested Use
8381	30	Multiple*	Synthetic Rubber/MOPP	55 (60)	97 (1709)	2.9 (0.073)	MAX OD 380mm (15")	6"	General purpose
8383	20	Multiple*	Synthetic Rubber/MOPP	48 (53)	90 (1580)	2.8 (0.071)	Plantery or Level-wound	6"	Apply on films

\*Available materials include: paper (2 grades), clear polyethylene, white polyethylene, polypropylene foam or polyethylene foam.

Note: This technical information and data should be considered representative or typical only and should not be used for specification purposes.



# Scotch® Multipack Tapes

**Economical and sustainable alternative to shrink films, banding, boxes and bags.**

- Effective way to bundle consumer products into multipacks and value packs
- Clear, strong tape holds firmly and removes cleanly without damaging the primary package graphics



Discrete tape highlights primary packaging.

## A Full Selection of Bundling Options

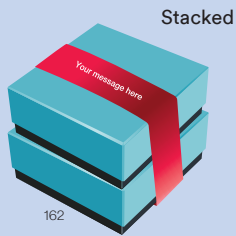

Custom carry handle option for convenience

Learn more about the Multipack Solution online. You'll find videos, and both tape and equipment details at [3M.com/Multipack](https://www.3m.com/Multipack)

Product	Color	Backing Material	Backing Thickness mils (mm)	Total Thickness mils (mm)	Tensile Strength lb/in (N/100mm)	Adhesive Type	Adhesion to Steel oz/in (N/100mm)	Elongation (%)	Comments
699	Clear	Polypropylene	1.6 (0.041)	2.6 (0.066)	30 (525)	Synthetic Rubber	46 (50)	160	Designed for bundling multi-unit primary packaging; Combine with 3M™ Carry Handles for bundling pouches; Apply manually or with automated equipment; 699CP is a custom printed version

**Note:** This technical information and data should be considered representative or typical only and should not be used for specification purposes.

# 3M™ Tape Pads

## No dispenser? No problem!

- **Portable** “peel and stick” convenience, 25 sheets per pad
- **Adheres** to bags, boxes, plastic film, powder coats, metals and glass
- **Removable tab** for easy handling
- **Stores easily** in pockets, drawers, tool boxes and part carts
- Used to repair, patch, seal, protect, reinforce, close and trap



3M™ Packaging Tape Pad 3750P



3M™ Tape Sheets 822

Product	Sheet Size(s)	Color	Tape Material	Total Thickness mil (mm)	Tensile Strength lb/in (N/100mm)	Adhesive Type	Adhesion Strength oz/in (N/100mm)	Elongation (%)	Tab
809G	Custom Size	Transparent, Red, Yellow	Polypropylene	3.1 (0.079)	35 (613)	Synthetic Rubber	55 (60)	160	Removable or Permanent
809GP	Custom Size w/Custom Print								
809S	Custom Size w/Custom Backsheet	Transparent	Polypropylene	3.1 (0.079)	35 (613)	Synthetic Rubber	55 (60)	160	Removable or Permanent
822	4" x 6"	Transparent	Polypropylene	3.1 (0.079)	35 (613)	Synthetic Rubber	55 (60)	160	Removable
3750P	2" x 6"								

# 3M™ Hang Tabs

- Clear, durable, polyester tabs with a pressure-sensitive adhesive for easy in-store repair of damaged packaging such as torn punches in chipboard header cards
- Clear tabs do not obscure packaging graphics — showcases existing packaging graphics and messaging
- Pre-cut, bendable tab format for convenience and ease of use
- Sticks to most product or packaging surfaces for store display applications

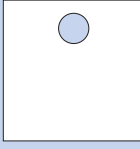
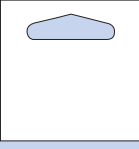

175

Hole Styles for Hang Tags		
 <p><b>J-Hook</b></p> <p>Consumer-friendly option, encourages item selection from anywhere on peg</p>	 <p><b>Round Hole</b></p> <p>For single-wire pegs</p>	 <p><b>Delta Hole</b></p> <p>For wider double-wire pegs or self-centers on standard pegs</p>



176

Product	Size (H x W)	Hole Style	Color	Hang Tabs per Pad	Backing Material	Total Thickness mil (mm)	Adhesive Type	Adhesion Strength oz/in (N/100mm)
1072	1-3/8" x 7/8"	J-Hook	Clear	Individual	Polyester	25.8 (0.66)	Synthetic Rubber	175 (192)
1074	1" x 2"	Round	Clear	10 per pad	Polyester	13.5 (0.34)	Synthetic Rubber	55 (60)
1075	2" x 2"	Delta	Clear	10 per pad	Polyester	13.5 (0.34)	Synthetic Rubber	55 (60)
1076	2" x 2"	Round	Clear	10 per pad	Polyester	13.5 (0.34)	Synthetic Rubber	55 (60)

Note: This technical information and data should be considered representative or typical only and should not be used for specification purposes.



# Scotch® Pouch Tapes

## Strong, low-profile attachment solution.

- “Trap it” with unique 3M tape construction — strong adhesive tape area on the edges frame the large, clear non-adhesive window area in the middle
- Attach documents, packing lists, invoices, literature, catalogs, brochures, or even product samples, small part packets or other merchandise
- Synthetic rubber adhesive sticks well to corrugate and many other substrates
- Custom-print option can personalize your message

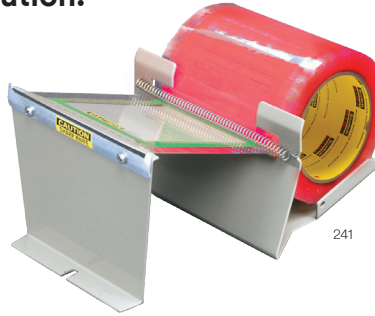

Scotch® Pouch Tape Dispenser M727 with Scotch® Pouch Tape 824RCT — Available in rolls for easy dispensing at pack stations.

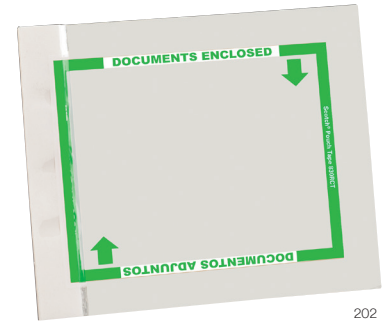

Scotch® Pouch Tape Sheets 830RCT are available in pads for portable back-pocket convenience. No liners help keep work areas clean of debris.

Product	Individual Pouch Size (h x w)	Printed Message	Applications	Core Size	Material Type	Total Thickness mils (mm)	Tensile Strength lb/in (N/100mm)	Adhesive Type	Adhesion Strength oz/in (N/100mm)	Dispenser Options
<b>Pads</b>										
830	5" x 6"	"Documents Enclosed"	25 per pad	—	Polypropylene	2.5 mil (0.064)	30 lb/in (525 N/100 mm)	Hot Melt Synthetic Rubber Resin	50 oz/in (54.7 N/100 mm)	—
830CP	5" x 6"	Custom Print	25 per pad	—		2.5 mil (0.064)	30 lb/in (525 N/100 mm)		50 oz/in (54.7 N/100 mm)	—
830RCT	5" x 6"	"Documents Enclosed"	25 per pad	—		2.5 mil (0.064)	30 lb/in (525 N/100 mm)		50 oz/in (54.7 N/100 mm)	—
	6" x 10"	"DOCUMENTS ENCLOSED"/"DOCUMENTOS ADJUNTOS"	25 per pad	—		2.5 mil (0.064)	30 lb/in (525 N/100 mm)		50 oz/in (54.7 N/100 mm)	—
	11" x 12"	"DOCUMENTS ENCLOSED"/"DOCUMENTOS ADJUNTOS"	25 per pad	—		2.5 mil (0.064)	30 lb/in (525 N/100 mm)		50 oz/in (54.7 N/100 mm)	—
830CN	5" x 6"	"DOCUMENTS ENCLOSED"/"DOCUMENTOS ADJUNTOS"	25 per pad	—		2.5 mil (0.064)	30 lb/in (525 N/100 mm)		50 oz/in (54.7 N/100 mm)	—
832	6" x 10"	"DOCUMENTS ENCLOSED"	25 per pad	—		2.5 mil (0.064)	30 lb/in (525 N/100 mm)		50 oz/in (54.7 N/100 mm)	—
832CP	6" x 10"	Custom Print	25 per pad	—		2.5 mil (0.064)	30 lb/in (525 N/100 mm)		50 oz/in (54.7 N/100 mm)	—
8240P	5" x 6"	"Packing List Enclosed"	25 per pad	—		2.5 mil (0.064)	30 lb/in (525 N/100 mm)		50 oz/in (54.7 N/100 mm)	—
<b>Rolls</b>										
824	5" x 6"	"Documents Enclosed"	333 per roll	3"	Polypropylene	2.5 mil (0.064)	30 lb/in (525 N/100 mm)	Hot Melt Synthetic Rubber Resin	50 oz/in (54.7 N/100 mm)	M727 or M797
8240	5" x 6"	"Documents Enclosed"	500 per roll	3"		2.5 mil (0.064)	30 lb/in (525 N/100 mm)		50 oz/in (54.7 N/100 mm)	M727 or M797
8240	5" x 8"	"Documents Enclosed"	500 per roll	3"		2.5 mil (0.064)	30 lb/in (525 N/100 mm)		50 oz/in (54.7 N/100 mm)	M727 or M797
	6" x 8"	"Documents Enclosed"	500 per roll	3"		2.5 mil (0.064)	30 lb/in (525 N/100 mm)		50 oz/in (54.7 N/100 mm)	M797
828CP	5" x 6"	Custom Print	—	3"		2.5 mil (0.064)	30 lb/in (525 N/100 mm)		50 oz/in (54.7 N/100 mm)	M727 or M797
	6" x 8"	Custom Print	—	3"		2.5 mil (0.064)	30 lb/in (525 N/100 mm)		50 oz/in (54.7 N/100 mm)	M727 or M797
829	5" x 6"	Packing List Enclosed	333 per roll	3"		2.5 mil (0.064)	30 lb/in (525 N/100 mm)		50 oz/in (54.7 N/100 mm)	M727 or M797

Note: This technical information and data should be considered representative or typical only and should not be used for specification purposes.

# Label Protection Tapes

**Protect labeled shippers, mailers, envelopes, tubes, drums, tubs.**

- Tape material options for use on wide range of substrates
- High clarity for sharp read-through accuracy
- Bright color tape option draws attention to important label content

Product	Roll Width(s) Available	Roll Length	Color	Backing Material	Total Thickness mils (mm)	Tensile Strength lb/in (N/100mm)	Adhesive Type	Adhesion Strength oz/in (N/100mm)	Elongation (%)	Comments
821	2", 3", 4", 5", 6"	72 yd	Pink	Acetate	2.5 (0.063)	12 (210)	Acrylic	25 (27)	15	Low-glare matte finish. Write-on surface; Hand-tearable — no dispenser needed
856	1", 1.5", 2", 3", 4", 6"	72 yd	Clear	Polyester	2.0 (0.051)	25 (438)	Acrylic	20 (22)	90	Excellent transparency and resistance to abrasion, moisture and chemicals; Go-to option for outdoor applications
3565	96mm, 120mm	100m	Clear	Polypropylene	1.9 (0.048)	22 (385)	Synthetic Rubber	40 (44)	160	Excellent transparency and conformability; Resists tearing, splitting, moisture, abrasion and smudges
3765	96mm, 120mm, 144mm	132m	Clear	Polypropylene	1.5 (0.038)	20 (350)	Acrylic	22 (24)	119	Good transparency; Recommended for cold temperature applications



242



# 3M™ Packing List Envelopes

## Wide variety of choices for document control and protection.

- Convenient peel-and-stick document protection
- Non-printed and printed with standard messages
- Custom sizes and/or custom printed messages
- Reclosable 3M™ Zipper Closure Envelope is available in two sizes
- Polyethylene backing/synthetic rubber adhesive/paper liner
- Backing thickness: 2.0 mil; Total thickness: 5.0 mil



**Easy Inspection** — For cross border shipping and other inspection situations, zipper closure envelopes open easily and close securely. Tough construction resists moisture and abrasion.

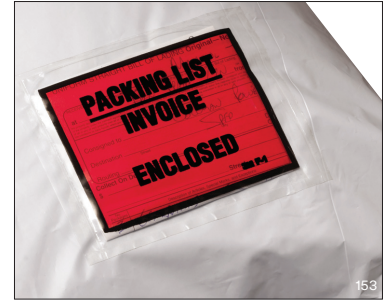









**Secure Adhesion** — High tack pressure sensitive adhesive on the back of the envelope grabs on contact and holds securely even to curved and flexible surfaces.

## T (Top Printed)

<p><b>T1</b> Packing List/ Invoice Enclosed 4.5" x 5.5" 1,000/case</p>  <p>side-load</p>	<p><b>T1 INV</b> Invoice Enclosed 4.5" x 5.5" 1,000/case</p>  <p>side-load</p>	<p><b>T3</b> Packing List/ Invoice Enclosed 7" x 5.5" 1,000/case</p>  <p>top-load</p>
<p><b>T1 PL</b> Packing List Enclosed 4.5" x 5.5" 1,000/case</p>  <p>side-load</p>	<p><b>T2</b> Packing List/ Invoice Enclosed 4.5" x 6" 1,000/case</p>  <p>side-load</p>	<p><b>T4</b> Packing List/ Invoice Enclosed 5.5" x 10" 1,000/case</p>  <p>side-load</p>

## NP (Non-Printed)

<p><b>NP1</b> No Print (Clear) 4.5" x 5.5" 1,000/case</p>  <p>side-load</p>	<p><b>NP6</b> No Print (Clear) 9.5" x 12" 1,000/case</p>  <p>side-load</p>
<p><b>NP2</b> No Print (Clear) 4.5" x 6" 1,000/case</p>  <p>side-load</p>	<p><b>NP9</b> No Print (Clear) 7" x 6" 1,000/case</p>  <p>top-load</p>
<p><b>NP3</b> No Print (Clear) 5.5" x 7" 1,000/case</p>  <p>top-load</p>	<p><b>FED1</b> No Print (Perfed) 6.75" x 10.75" 500/case</p>  <p>top-load</p>
<p><b>NP4</b> No Print (Clear) 5.5" x 10" 1,000/case</p>  <p>side-load</p>	
<p><b>NP5</b> No Print (Clear) 7" x 10" 1,000/case</p>  <p>side-load</p>	

## F (Full Face Printed)

**F1**  
Packing List/  
Invoice Enclosed  
4.5" x 5.5"  
1,000/case



side-load

## Zipper Closure Envelopes

<p><b>NPZ-L</b> No Print (Clear) 8.5" x 11.5" 500/case</p>	<p><b>NPZ-XL</b> No Print (Clear) 10" x 12.5" 500/case</p>
--	--





# Sustainable Packaging Solutions





3M™ Sustainable  
Packaging Solutions

# A more responsible future for the packaging industry.

Consumers, government regulators, and corporations are all demanding more eco-friendly packaging. 3M is here to help you meet these challenges and deliver what your customers are asking for without sacrificing the performance you need and deserve.

## Step by step.

We are with you on every step of your journey toward sustainability. Here are just a few of the ways our packaging solutions help you meet your goals:



We continue to develop packaging and products that are **reusable, renewable, recyclable**, or made with more recycled material.



We're creating solutions that can be **recycled after use** rather than discarded.



We offer packaging solutions that do more with less material, helping **reduce the environmental footprint** of the packaging industry.



Our manufacturing team is working to make production processes more **energy-efficient** and increase our usage of **renewable energy**.



# 3M™ Padded Automatable Curbside Recyclable (PACR) Mailer Material

## Automatable for you. Simple for your customers.

The 3M™ Padded Automatable Curbside Recyclable (PACR) Mailer Material is a paper-based solution that delivers the protection and performance you need with the sustainability focus you want. Designed for use with automated packaging machines, it withstands the rigors of shipping while being automatable for you and simple for your customers.



184



### Sustainability focused

- Certified recyclable just like paper or a cardboard box\*
- Only uses a single layer of kraft paper
- Certified Repulpable by Western Michigan University with >99% fiber recovery
- Lightweight, which can help reduce carbon emissions in transit
- Supports right-sized packaging



### Protective performance

- Proprietary padding technology
- Enables ISTA-3A certification
- Durable with strong protection against drops, bursts, vibration, and more
- Designed to resist moisture penetration
- Withstands the rigors of shipping



### Automatable

- Facilitates fast and efficient operations
- Enables labor redeployment
- Heat sealable with potential dwell times under one second
- Compatible with a variety of printing technologies
- Available in a variety of widths

\*Curbside recyclable where facilities are available

## Introducing the NEW! Scotch® Performance Paper Tape 570

### Striking the perfect balance between performance and sustainability.

Scotch® Performance Paper Tape 570 is an ideal alternative to conventional box sealing tapes when sustainability is a priority. Optimal for palletized and lightweight, single-parcel shipments.



### Additional Features Include:

- Recycle-compatible when left on the box according to Western Michigan University (WMU) Recyclability testing.
- Features a strong backing made from responsibly sourced paper and a solvent-free hot melt adhesive.
- Reliably adheres to various surfaces, including cartons with high levels of recycled content
- Equally applicable for manual use and machine/automated processes

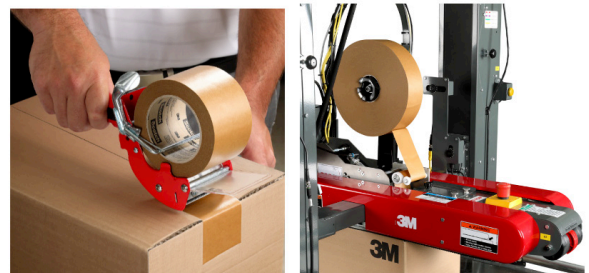

**Note:** This technical information and data should be considered representative or typical only and should not be used for specification purposes.



# Glossary

This glossary is compiled by the Pressure Sensitive Tape Council (PSTC) and 3M (terms identified with an asterisk). PSTC is the North American trade association for tape manufacturers and affiliate suppliers, dedicated to helping the industry produce quality pressure sensitive adhesive tape products in the global marketplace. Visit [pstc.org](https://www.pstc.org) for more information.

## **Abrasion Resistance**

The ability of a tape to withstand rubbing and still function satisfactorily.

## **Acrylic Adhesive\***

A pressure sensitive, viscoelastic blend of acrylic-based materials which may be modified by tackifying additives. Acrylic adhesives are a very broad class of materials and come in many types to achieve different properties.

## **Adhesion to Backing**

The bond produced to the backing of the same tape or another tape backing.

## **Adhesive Deposit or Residue**

Adhesive that is pulled away from the tape upon removal and remains on the surface to which it has been applied.

## **Adjustable Case Sealer**

A case sealer that must be manually adjusted for box width and height. Accepts runs of one box size at a time.

## **Article Letters\***

Letters if a MSDS does not exist on a product.

## **Backing**

A relatively thin flexible material to which the adhesive is applied. Theoretically, any material that is reasonably flat, thin and flexible can be used as a tape backing.

## **Backsize**

An occlusive coating applied to the non-pressure sensitive side of a porous backing, such as paper, in order to provide a satisfactory surface that the pressure sensitive adhesive side can contact when the tape is wound into a roll.

## **Caliper**

The thickness (as of a sheet of paper) measured under specified conditions. See also THICKNESS.

## **Co-extruded\***

Refers to film extruded in individual layers with the possibility of different raw materials in each layer providing unique combined film properties.

## **Conformability\***

The ability for a tape to make arcs, circles, go into depressions, go over protrusions and still stay in one piece without slivering or tape lifting or necking down.

## **Containment**

To confine and hold in place.

## **Controlled Unwind\***

When a balance is achieved between too low of an unwind, allowing the tape to prematurely unwind from its own backing, or too high, causing premature slivering or breaking when unwinding from its roll.

## **Elastomer**

An elastic, polymeric substance, such as natural or synthetic rubber.

## **Elongation (Stretch, Ultimate Elongation)**

The distance a tape will stretch in the machine or cross direction before breaking under controlled conditions, expressed as a percentage of original length. Elongation is not necessarily an indication of conformability.

## **Extruded\***

A manufacturing process where material is forced through a nozzle (like extruded film or backing). Better for lay-flat than skived.

## **FOL**

Full overlap.

## **Filaments**

Thin, longitudinal yarns or threads of glass, polyester, nylon or other high strength materials.

## **Holding Power (Shear Adhesion, Shear Resistance)**

The ability of a tape to resist static forces applied in the same plane as the backing. Usually expressed in a time required for a given weight and length of tape to shear free from a vertical panel.

## **Hot Melt (Pressure Sensitive Adhesive)**

A pressure sensitive adhesive, applied to the backing in hot liquid form, which then cools to form a conventional pressure sensitive adhesive.

## **Humidity**

The moisture content of the air. Actual humidity is the number of grams of moisture in the air at any given time. Relative humidity is the percent of moisture relative to the maximum that air at any given temperature can retain without precipitation.

## **Impact Resistance (Shock Resistance)**

The ability of a tape to resist sudden impacts, pulls, or shocks as may sometimes be encountered by packages in transit.

## **L-Clip**

Tape seal applied over the edge of non-RSCs with one leg down the side and the other on the top and/or bottom.

## **Moisture Vapor Transmission Rate**

A measure of the rate of water vapor transmission through a pressure sensitive product usually measured in grams per square meter per 24 hours.

## **MOPP**

Monoaxially-oriented polypropylene tape construction.

## **NPE\***

An NPE number is used to designate an experimental product. NPE products are often provided to customers for evaluation purposes only, and may or may not be commercialized.

## **Non-RCS**

All box structures other than RSC (Regular Slotted Carton).

## **Off-Core**

A roll of tape in which the layers are in correct alignment, but the tape is displaced sideways on the core.

## **Opacity**

The ability of a tape to prevent the transmission of light.

## **Pad**

Pre-cut, tape strips stacked on a pad for easy one-at-a-time removal.

\*Compiled by 3M.

# Glossary

## **PE\***

The abbreviation for polyethylene. Usually extruded in a single (mono) layer.

## **Peel Adhesion**

The force per unit width required to break the bond between a pressure sensitive adhesive tape and the surface to which it has been applied when the tape is peeled back at a controlled angle at a standard rate and condition.

## **PLE**

Packing List Envelope.

## **Pouch Tape**

Tape with adhesive-free area within a perimeter of pressures sensitive adhesive. When applied the adhesive-free area forms a containment pouch.

## **PP\***

Abbreviation for polypropylene. Usually manufactured as a single (mono) layer via a casting process.

## **Pressure Sensitive**

A term commonly used to designate a distinct category of adhesive tapes and adhesives which in dry form (solvent/ water free) are aggressively and permanently tacky at room temperature and that firmly adhere to a variety of dissimilar surfaces upon mere contact without the need of more than finger or hand pressure. These products require no activation by water, solvent, or heat in order to exert a strong adhesive holding force toward such materials as paper, plastic, glass, wood, cement, and metal. They have sufficient cohesive holding power and elastic nature so that, despite their aggressive tackiness, they can be handled with the fingers and removed from smooth surfaces without leaving a residue.

## **Quick Stick (Finger Tack, Initial Adhesion, Wet Grab)**

See TACK.

## **Random Case Sealer**

A case sealer that automatically adjusts for case width and height. Typically used for runs of different box sizes.

## **Recouperage**

To salvage goods within a container that has broken or opened during shipment.

## **Release Force**

The measure of the force required to separate a unit width of pressure sensitive tape from a release coated surface at a controlled angle and speed.

## **Retroreflective**

Surface, material, or device that reflects light back to its source.

## **RGT**

Reinforced Gum Tape.

## **RSC**

Regular Slotted Carton.

## **Rubber Adhesive\***

A pressure sensitive, viscoelastic blend of polymeric rubber-based materials and tackifying resin. The rubber materials may be natural or synthetic. Rubber adhesives are a very broad class of materials and come in many types to achieve different properties.

## **Shear Adhesion**

The time required, under specified test conditions (surface area, weight load), to slide a standard area of pressure sensitive tape from a standard flat surface in a direction parallel to the surface.

## **Single Faced (Coated)**

A tape to which a pressure sensitive adhesive is applied to only one side of the backing.

## **Solvent/Chemical Resistant\***

Ability to resist common solvents or chemicals.

## **Surface Energy (Surface Wetting Ability)**

The measure of surface tension in dynes. The lower the surface energy of a substrate, the more difficult it becomes for an adhesive or coating to wet out that surface.

## **Tack**

The property of a pressure sensitive adhesive that allows it to adhere to a surface under very slight pressure. It is determined by the ability of the adhesive to wet quickly the surface it contacts.

## **Tear Resistance**

The force required to propagate a tear in a tape in a given direction after the tear has been initiated.

## **Telescoping**

A sideways sliding of the tape layers, one over another, such that the roll looks like a funnel or a telescope, usually occurring over a period of time.

## **Tensile Strength**

The force required to break a unit width of tape by controlled pulling on opposite ends of the piece.

## **Thickness (Caliper, Gauge)**

The perpendicular distance from one surface of either a tape, backing or adhesive to the other, usually expressed in mils, thousandths of an inch or millimeters. This is usually measured under controlled slight pressure with a special gauge.

## **TSCA\***

Toxic Substances Control Act.

## **U-Clip**

Tape seal applied to an RSC carton with tape legs down both sides of the carton and across the center seam.

## **UL 723\***

UL 723 deals mainly with flammability.

## **Unwind or Unwind Adhesion**

The force required to remove tape from a roll under prescribed conditions.

## **Water Vapor Transmission (WVTR)**

The weight of water vapor allowed through a controlled area of tape within a specified time period and under controlled conditions.

\*Compiled by 3M.



# Numerical Index

2000a.....	6,8	3775.....	27	HB900 .....	17
2000a3.....	8	3779.....	27	HB901.....	17
302.....	23	5910.....	29	HB902.....	17
305.....	23	6141 .....	27	HB903.....	17
311+ .....	23, 24, 26	6142 .....	27	HR80 .....	17
313.....	23	6143.....	27	HR83 .....	17
315.....	23	6144 .....	27	HR933.....	17
351.....	23	6145.....	27	M82 .....	17
353.....	23	6146.....	27	M96 .....	17
355.....	23	6147.....	27	M707 .....	17
355CP.....	25	7000a Pro.....	6, 8	M727 .....	17
371.....	23	7000a3 Pro.....	8	M797 .....	17
371+.....	23, 24	7000r HS Pro.....	7, 10	M900 .....	17
371CP.....	25	7000r Pro.....	7, 10	M920 .....	17
373 .....	23	7000r3 HS Pro .....	10	P52.....	17
373+.....	23	7000r3 Pro .....	10	P52W.....	17
375 .....	23	8000a.....	6, 9	P56.....	17
375+.....	23, 24	8000a3.....	9	P56W .....	17
375CP.....	25	8000ab.....	6, 9	P400 .....	17
570.....	40	8000af.....	6, 9	P448 .....	17
600 .....	28, 29	8000af3 .....	9	PACR .....	40
605 .....	29	8000asb.....	6, 9	S634 .....	17
640 .....	29	8000r.....	7, 10	S867 .....	7, 13
640+ .....	29	8004.....	29	S867 II.....	7, 13
681.....	29	8310.....	32	W100 .....	17
690 .....	29	8315.....	32	W200 .....	17
700a-s.....	6, 8	8320 .....	32		
8000ab.....	6, 9	8330 .....	32		
8000ab3 .....	9	8346 .....	32		
8000asb.....	6, 9	8346HP .....	32		
8000r.....	7, 10	8350.....	32		
8000r3 .....	10	8381.....	32		
800rks.....	7, 10	8383 .....	32		
809GP.....	34	C22 .....	17		
809S.....	34	C23 .....	17		
822 .....	34	C25 .....	17		
856.....	29, 36	H12 .....	17		
1072.....	34	H121 .....	17		
1074.....	34	H122 .....	17		
1075 .....	34	H123 .....	17		
1076 .....	34	H128.....	17		
3071CP.....	23	H131.....	17		
3073 .....	22	H133 .....	17		
3073CP.....	23	H150 .....	17		
3199.....	27	H153.....	17		
3565 .....	34	H180 .....	17		
3750P.....	34	H183 .....	17		
3765.....	36	H190 .....	17		
3771.....	27	H192 .....	17		
3772 .....	27	H320 .....	17		

# Product Name Index

## 3M™ AccuGlide™ Taping Heads

2+ .....	12
3 .....	12
4 .....	12
LHB .....	12
NPH .....	12
NPH+ .....	12

## 3M-Matic™ Adjustable Case Sealers

2000a .....	8
7000a Pro .....	8
7000a3 Pro .....	8
700a-s .....	8
8000a .....	9
8000a3 .....	9
8000af .....	9
8000ab .....	9
8000af3 .....	9
8000asb .....	9

## 3M-Matic™ Random Case Sealers

8000r .....	12
8000r3 .....	12
8000rks .....	12
7000r HS Pro .....	12
7000r Pro .....	12
7000r3 HS Pro .....	12
7000r3 Pro .....	12

## 3M™ Padded Automatable Curbside Recyclable (PACR) Mailer Material

PACR .....	40
------------	----

## Box Sealing Tapes

311+ .....	23
302 .....	23
305 .....	23
313 .....	23
315 .....	23
351 .....	23
353 .....	23
355 .....	23
369 .....	23
371 .....	23
371+ .....	23
373 .....	23
375 .....	23

## Carry Handles

8310 .....	32
8315 .....	32
8320 .....	32
8330 .....	32
8346 .....	32
8346HP .....	32
8350 .....	32
8381 .....	32
8383 .....	32

## Cold Temperature Tape

311+ .....	26
------------	----

## Custom Printed Box Sealing Tapes

355CP .....	25
371CP .....	25
373CP .....	25
375CP .....	25
3071CP .....	25
3073CP .....	25

## Water Activated Tapes

6141 .....	27
------------	----

## Hang Tabs

1072 .....	34
1074 .....	34
1075 .....	34
1076 .....	34

## Label Protection Tapes

821 .....	36
856 .....	36
3565 .....	36
3765 .....	36

## Light Duty Packaging Tapes

600 .....	28, 29
605 .....	28, 29
640 .....	28, 29
640+ .....	28, 29
640+ .....	28, 29
681 .....	29
690 .....	29
856 .....	29
5910 .....	29
8004 .....	29

## Manual Tape Dispensers

C22 .....	17, 18, 19
C23 .....	17, 18, 19
C25 .....	17, 18, 19
H12 .....	17, 18, 19
H121 .....	17, 18, 19
H122 .....	17, 18, 19
H123 .....	17, 18, 19
H128 .....	17, 18, 19
H131 .....	17, 18, 19
H133 .....	17, 18, 19
H150 .....	17, 18, 19
H153 .....	17, 18, 19
H180 .....	17, 18, 19
H183 .....	17, 18, 19
H190 .....	17, 18, 19
H192 .....	17, 18, 19
H320 .....	17, 18, 19
HB900 .....	17, 18, 19
HB901 .....	17, 18, 19
HB902 .....	17, 18, 19
HB903 .....	117, 18, 19
HR80 .....	17, 18, 19
HR83 .....	17, 18, 19
HR933 .....	17, 18, 19
M82 .....	17, 18, 19
M96 .....	17, 18, 19
M707 .....	17, 18, 19
M727 .....	17, 18, 19
M797 .....	117, 18, 19
M900 .....	17, 18, 19
M920 .....	17, 18, 19
P52 .....	17, 18, 19
P52W .....	17, 18, 19
P56 .....	17, 18, 19
P56W .....	17, 18, 19
P400 .....	17, 18, 19
P448 .....	17, 18, 19
S634 .....	17, 18, 19
W100 .....	17, 18, 19
W200 .....	17, 18, 19



# Product Name Index

## Non-RSC Closure Solutions

S867 .....	13
S867II .....	13

## Packing List Envelopes

F1 .....	37
FED1 .....	37
NP1 .....	37
NP2 .....	37
NP3 .....	37
NP4 .....	37
NP5 .....	37
NP6 .....	37
NP9 .....	37
NPZ-L .....	37
NPZ-XL .....	37
T1 .....	37
T1 INV .....	37
T1 PL .....	37
T2 .....	37
T3 .....	37
T4 .....	37

## Pouch Tapes

830RCT .....	35
--------------	----

## Scotch® Custom Printed Box Sealing Tapes

311+ .....	25
371+ .....	25
3073 .....	25

## Reinforced Strapping Tapes

862 .....	29, 33
863 .....	33
864 .....	33
865 .....	33
8651 .....	33

## Scotch® Plus+ Series Tapes

311+ .....	24
374+ .....	24
373+ .....	24
375+ .....	24

## Security Tapes

3199 .....	27
3732 .....	27
3771 .....	27
3772 .....	27
3775 .....	27
3779 .....	27

## Scotch® Performance Paper Tape 570

8884 .....	40
------------	----

## Stretchable Tapes

8884 .....	17
8886 .....	17

## Tape Pads

809G .....	34
809S .....	34
822 .....	34
3750P .....	34

## Water Activated Tapes

6141 .....	27
6142 .....	27
6143 .....	27
6144 .....	27
6145 .....	27
6146 .....	27
6147 .....	27

# We're here to help.

Need help finding the right product for your packaging needs? Contact us if you need product, technical or application advice or want to collaborate with a 3M technical specialist, or give us a call at 1-800-831-0658.

**3M Custom Packaging Hotline: 1-800-253-2329**

**3M Industrial Technical Support: 1-888-726-8244**

**3M-Matic™ Application Support Helpline: 1-800-328-1390**

**3M-Matic™ and Tape Dispenser Replacement Parts: 1-800-344-9883**

**Product Selection and Use:** Many factors beyond 3M's control and uniquely within user's knowledge and control can affect the use and performance of a 3M product in a particular application. As a result, customer is solely responsible for evaluating the product and determining whether it is appropriate and suitable for customer's application, including conducting a workplace hazard assessment and reviewing all applicable regulations and standards (e.g., OSHA, ANSI, etc.). Failure to properly evaluate, select, and use a 3M product and appropriate safety products, or to meet all applicable safety regulations, may result in injury, sickness, death, and/or harm to property.

**Warranty, Limited Remedy, and Disclaimer:** Unless a different warranty is specifically stated on the applicable 3M product packaging or product literature (in which case such warranty governs), 3M warrants that each 3M product meets the applicable 3M product specification at the time 3M ships the product. 3M MAKES NO OTHER WARRANTIES OR CONDITIONS, EXPRESS OR IMPLIED, INCLUDING, BUT NOT LIMITED TO, ANY IMPLIED WARRANTY OR CONDITION OF MERCHANTABILITY, FITNESS FOR A PARTICULAR PURPOSE, OR ARISING OUT OF A COURSE OF DEALING, CUSTOM, OR USAGE OF TRADE. If a 3M product does not conform to this warranty, then the sole and exclusive remedy is, at 3M's option, replacement of the 3M product or refund of the purchase price.

**Limitation of Liability:** Except for the limited remedy stated above, and except to the extent prohibited by law, 3M will not be liable for any loss or damage arising from or related to the 3M product, whether direct, indirect, special, incidental, or consequential (including, but not limited to, lost profits or business opportunity), regardless of the legal or equitable theory asserted, including, but not limited to, warranty, contract, negligence, or strict liability.

3M, 3M-Matic, AccuGlide, Scotchlite and Tartan are trademarks of 3M Company. Scotch is a registered trademark of 3M Company.



**Industrial Specialties Division - Packaging**  
**3M Center, Building 223-4NE**  
**St. Paul, MN 55144-1000**

**Phone** 800-362-3550  
**Fax** 877-369-2923  
**Web** 3M.com/Packaging

Please recycle. Printed in USA.  
© 3M 2024. All rights reserved.  
70-0710-0432-2 Rev Sept 2023