

FEATURES & SPECIFICATIONS

INTENDED USE — Intended for low to medium mounting heights where dust, dirt, humidity or moisture are present. Ideal for canopies, dock areas, wastewater treatment, refrigerated areas, food processing and other non-hazardous environments. Not for use or installation in direct outdoor sunlight. Must be installed under canopy or covered ceiling. For direct sunlight installations, please refer to the [FEX](#) product family. **Certain airborne contaminants can diminish the integrity of acrylic and/or polycarbonate.** [Click here for Acrylic-Polycarbonate Compatibility table for suitable uses.](#)

CONSTRUCTION — Housing formed from impact resistant, UV stabilized, fiberglass reinforced polyester with cold-rolled steel enclosed wireway. Poured in place gasketing provides a seal between housing and diffuser. Captive, corrosion-resistant cam-action latches secure the diffuser; 10 on 4' units, and ten on 8' units. Stainless steel latches available.

Finish: Painted parts pretreated with a five-stage iron-phosphate process to ensure superior paint adhesion and corrosion resistance, then finished with a high-gloss, baked white enamel.

OPTICS — High-impact acrylic diffuser with a stippled interior surface to spread lamp image.

PLEASE NOTE: The standard 4' diffuser is 2-1/4" deep, and the standard 8' or 48T8HO diffuser is 3" deep. To order the 4' diffuser so that it matches the depth of the 8' diffuser, order the ARDP option. The 8' diffuser is not available in the 2-1/4" depth.

ELECTRICAL — Thermally protected, resetting, Class P, HPF, non-PCB, UL Listed and CSA Certified ballast is standard.

AWM, TFN, THHN wire throughout, rated for required temperatures.

INSTALLATION — For unit or row installations, surface (ceiling or wall) or suspended mounting. Wall mounting; horizontal orientation only for use in damp locations. Stainless steel surface spring-mounting brackets standard (2 included).

LISTINGS — 120V, 277V and MVOLT are UL Listed and CSA Certified (standard). 347V is CSA Certified (see Options). NOM Certified (see Options). Listed for 25°C ambient and wet locations for covered-ceiling applications. Compliance to FDA/USDA requirements and/or NSF splash-zone certification.

WARRANTY — 1-year limited warranty. Complete warranty terms located at:

www.acuitybrands.com/support/warranty/terms-and-conditions

Note: Actual performance may differ as a result of end-user environment and application.

Specifications subject to change without notice.

Catalog Number
Notes
Type

Enclosed and Gasketed Industrial

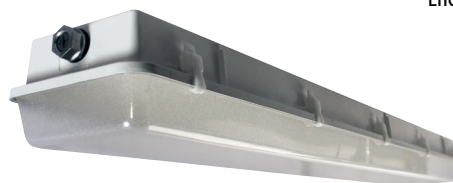

DMW

**INSTANT, PROGRAMMED
OR RAPID START**

4' or 8' length
1, 2 or 3 lamps



ORDERING INFORMATION

Lead times will vary depending on options selected. Consult with your sales representative.

Example: DMW 2 32 MVOLT GEB10IS

DMW	Series	Number of lamps	Lamp type	Diffuser	Voltage	Ballast	Options
DMW	DMW	1	28T5 28W T5 (48") ³	(blank)	120	GEB10IS	EL6DW Emergency battery pack (nominal 600 lumens), CA Title 20 noncompliant ^{7,8,9}
	Wet location	2	32 32W T8 (48")		277		EL14DW Emergency battery pack (nominal 1400 lumens), CA Title 20 noncompliant ^{7,8,9}
	For tandem double-length unit, add prefix T. Example: TDMW ¹	3 ²	48T8HO 44W T8HO (48")	ARDP	347	GEB10RS	GLR Internal fast-blow fusing (not available with MVOLT or 347V) ¹⁰
		Lamps not included	54T5HO 54W T5HO (48") ⁴	3" Deep high-impact acrylic (50% DR) ⁵	MVOLT others available	GEB10PS	GMF Internal slow-blow fusing (not available with MVOLT) ¹⁰
			96T8 59W T8 slimline (96")				RIF1 Radio interference filter, one per fixture
			96T8HO 86W T8 380mA (96")				STSL Stainless steel latches
							WLF Wet location fittings (one pair; installed, top, for use with 1/2" rigid conduit)
							CS89 6' white cord, 16/3, no plug, wet location
							CS88 6' Brad Harrison 16/3 cord and straight blade plug set wet location ¹⁰
							MSI_ Wet location occupancy sensor pre-wired ^{10,11}
							CSA CSA certified (only required for 347V)
							NOM NOM certified ¹²

Accessories: Order as separate catalog number.	
BCD	Bracket for hanger chain mounting. Two per package ¹³
HC36	Chain hangers (1 pair, 36" long); Requires BCD
WLF	Wet location fittings (1 pair, not installed, for use with 1/2" rigid conduit)

Replacement Parts: Order as separate catalog number.	
DDM48	2-1/4" Deep high-impact acrylic (50 DR) replacement lens for 48" fixture
DDM96	3" Deep high-impact acrylic (50% DR) replacement lens for 96" fixture ⁵
DDM48 ARDP	3" Deep high-impact acrylic (50% DR) replacement lens for 48" fixture ⁵
DMW/VRISMB	Surface mounting brackets (pair) ¹⁴

Notes

1 Not available with 96T8 or 96T8HO.

2 28T5 lamps only.

3 Must specify GEB10PS ballast.

4 Must specify GEB10PS90 ballast.

5 ARDP standard on 48T8HO and 8' fixtures.

6 Available 347V T8 only.

7 Must specify voltage; 120 or 277V only.

8 Not available to ship into California, CA Title 20 noncompliant.

9 See [PS600DW](#) or [PS1400DW](#) spec sheet for more information.

10 Must specify voltage.

11 For mounting up to 8' specify MS18; for mounting up to 20' specify MS120.

12 32W lamp with GEB10PS ballast is not available.

13 For stainless steel, specify STS (ex: BCD STS).

14 Brackets ship standard with fixture. For replacement purposes only.

DMW Instant, Programmed or Rapid Start

MOUNTING DATA

For unit or row installation, surface (ceiling or wall) or suspended mounting.

DMW — Drill holes through housing and channel at appropriate locations. Includes gasketed wet location fittings on ends for power feeding/mounting. Fitting is threaded for 1/2" rigid conduit (optional WLF for top mounting). Attach to surface using fasteners and sealing washers (by others) appropriate for ceiling materials.

Unit installation — Minimum of two hangers required.

Row installation — Minimum of two hangers required. Recommended 1/2" nipple with union (by others) for DMW.

MOUNTING ACCESSORIES

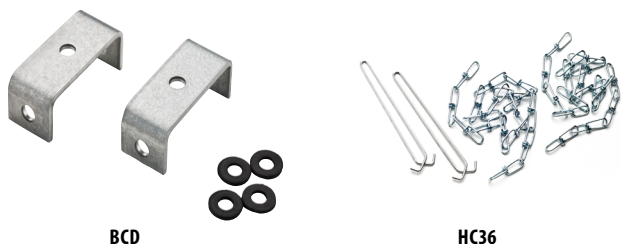

BCD

HC36

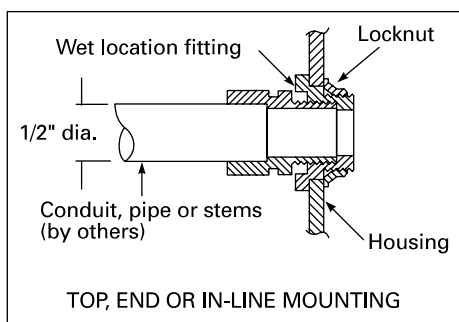

DIMENSIONS

- Length: 50 (127.0)
98 (248.9)
- Width: 8-1/8 (20.6)
- Fixture depth: 5-5/8 (14.3) (deep lens)
4-3/4 (12.1) (standard lens)

All dimensions are shown in inches (centimeters) unless otherwise noted.

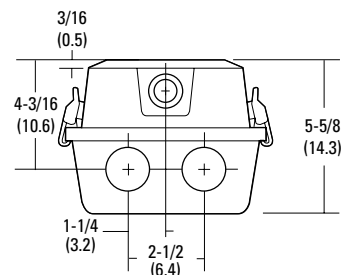
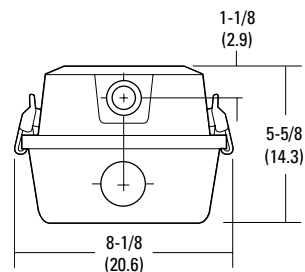

- A = 11/16 (17) Dia.
- B = 1-1/8 (29) Dia.
- Recommended mounting locations (field drilling required)

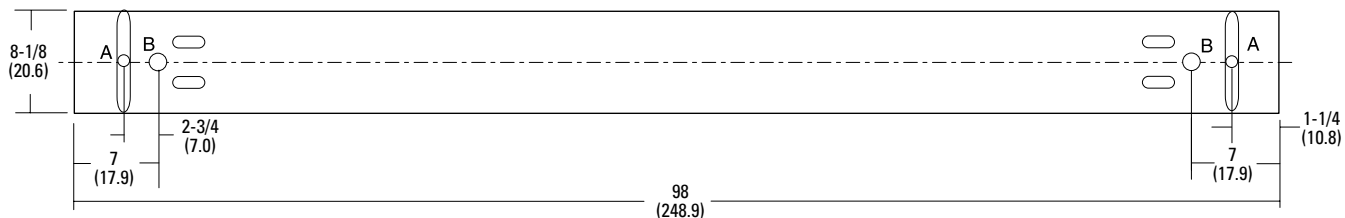
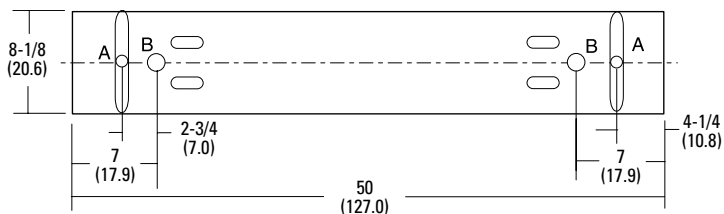

PHOTOMETRICS

See www.lithonia.com