

Manual Motor Control Switches and Disconnects

Vario™, GS1, GS2, LK4, MD Enclosed, TeSys™ DF Fuseholders

Catalog
9421CT0301R03/16
2016

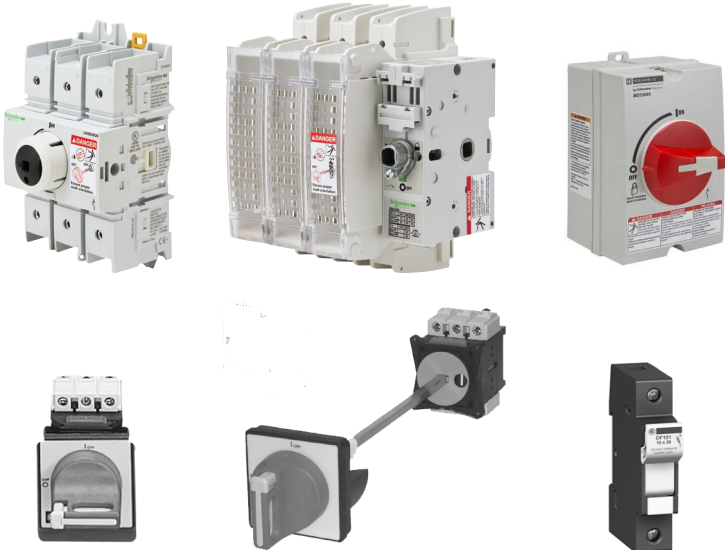

CONTENTS





| Description | Page |
|--|------|
| Mini-Vario and Vario Manual Motor Control Switches | 3 |
| GS1 and GS2 Fusible and LK4 Nonfusible Disconnect Switches | 26 |
| MD Enclosed Motor Disconnect Switch | 39 |
| TeSys DF IEC-Type Fuseholders | 41 |
| Index of Catalog Numbers | 48 |

Manual Motor Control Switches and Disconnects

Mini-Vario and Vario Manual Motor Control Switches

Mini-Vario and Vario Manual Motor Control Switches

Product Description

| | | | | | | | | | | | | |
|--|---|-------------|----------------|--|--------------|--------------|--|-------------|--|---|---------------|--|
| Applications | Mini-Vario and Vario rotary manual motor control switches from 12 to 175 A are suitable for on-load making and breaking of resistive or mixed resistive and inductive circuits where frequent operation is required. They can also be used for direct switching of motors in utilization categories AC-3 and DC-3 specific to motors. Vario manual motor control switches are suitable for isolator applications with fully visible indication (since the handle cannot be in the open position unless all the contacts are actually open and separated by the appropriate isolating distance) and it is possible to padlock the handles. | | | | | | | | | | | |
| |  | | |  | | |  | | |  | | |
| Switch type | Mini-Vario for standard applications | | | Vario for high performance applications | | | | | | | | |
| Thermal current, UL/IEC | 10 A / 12 A | 16 A / 20 A | 10 A / 12 A | 16 A / 20 A | 20 A / 25 A | 20 A / 32 A | 25 A / 40 A | 45 A / 63 A | 63 A / 80 A | 100 A / 125 A | 110 A / 175 A | |
| Operational current AC-23 A at 400 V | 8.1 A | 11 A | 8.1 A | 11 A | 14.5 A | 21.6 A | 29 A | 41.5 A | 57 A | 68.5 A | 83 A | |
| Number of poles | 3 to 5 | 3 to 5 | 3 to 6 | 3 to 6 | 3 to 6 | 3 to 6 | 3 to 6 | 3 to 6 | 3 to 6 | 3 + N + PE | 3 + N + PE | |
| Number of auxiliary contacts | 1 or 2 | 1 or 2 | 1 to 4 | 1 to 4 | 1 to 4 | 1 to 4 | 1 to 4 | 1 to 4 | 1 to 4 | 1 to 4 | 1 to 4 | |
| Switch mounting from the front | Screw mounting 1 or 4 holes 1 x \varnothing 0.88 in. (1 x \varnothing 22.5 mm) hole or 1 x \varnothing 0.2 in. (4 x \varnothing 5.5 mm) screws | | | Screw mounting 1 or 4 holes 1 x \varnothing 0.88 in. (1 x \varnothing 22.5 mm) hole or 1 x \varnothing 0.2 in. (4 x \varnothing 5.5 mm) screws | | | | | 1 x \varnothing 0.2 in. (4 x \varnothing 5.5 mm) screw | | | |
| Switch mounting from the back | Clip-on mounting on DIN rail | | | Clip-on mounting on DIN rail or screw | | | | | | Screw | | |
| Reversible terminal blocks | Yes | Yes | Yes | Yes | Yes | Yes | Yes | Yes | Yes | Yes | Yes | |
| Door mounting | Yes | Yes | Yes | Yes | Yes | Yes | Yes | Yes | Yes | Yes | Yes | |
| Mounting at back of enclosure with door interlock | Yes | Yes | Yes | Yes | Yes | Yes | Yes | Yes | Yes | Yes | Yes | |
| Enclosure catalog number ¹ | V•DN12 | V•DN20 | V•D02 V•F02 | V•D01 V•F01 | V•D0 V•F0 | V•D1 V•F1 | V•D2 V•F2 | V•F3 | V•F4 | V•F5 | V•F6 | |

¹ Enclosures not UL Listed.



International Acceptance

UL Listed, CSA Certified, IEC Rated, CE Marked, and most other applicable international standards.

UL508, CSA 22.2 No. 14 - UL File # E164864 CCN NLRV, CSA File # LR81630 Class 3211 05.

Suitable for use in equipment or machinery as manual motor controllers and horsepower and ampere rated.

IEC

Tested in accordance to IEC 60947-3, IEC 60529, and IEC 60695-2-1.

CE

Compliance with the European Machine Directive IEC 60204.

Manual Motor Control Switches and Disconnects

Mini-Vario and Vario Manual Motor Control Switches

| Switch type | VN12 VZN12 | V02 VZ02 | VN20 VZN20 | V01 VZ01 | V0 VZ0 | VVD0 VVE0 | V1 VZ1 | VVD1 VVE1 |
|--|---|-------------|---------------|-------------|------------|--------------|-----------|--------------|
| Environment | | | | | | | | |
| Conforming to standards | IEC 60947-3 | | | | | | | |
| Approvals | UL, CSA, GL, UL File # E164864 CCN NLRV, CSA File # LR81630 Class 3211 05 | | | | | | | |
| Protective treatment | "TC" | | | | | | | |
| Degree of protection with protection shroud | IP 20 conforming to IEC 60529 | | | | | | | |
| Ambient air temperature | -4 to +122 °F (-20 to +50 °C) | | | | | | | |
| Flame resistance | 1760 °F (960 °C) conforming to IEC 60695-2-1 | | | | | | | |
| Shock resistance 1/2 sine wave = 11ms conforming to IEC 60068-2-27 | 15 g | 30 g | 15 g | 30 g | | | | |
| Vibration resistance 10 to 150 Hz conforming to IEC 60068-2-6 | 5 g | 1 g | 1 g | 1 g | | | | |
| Electrical characteristics, AC operation | | | | | | | | |
| Rated operational voltage (Ue) | 690 V | 690 V | 690 V | 690 V | 690 V | 690 V | 690 V | 690 V |
| Rated impulse withstand voltage (Uimp) | 6 kV | 8 kV | 6 kV | 8 kV | 8 kV | 8 kV | 8 kV | 8 kV |
| Conventional thermal currents in free air (Ith) and rated uninterrupted (Iu) | 12 A | | 20 A | | 25 A | | 32 A | |
| Conventional thermal current in enclosure (Ithe) | 10 A | | 16 A | | 20 A | | 25 A | |
| Rated operational power and current | | | | | | | | |
| AC-21A/22A | 230 to 690 V | A | 12 | 20 | 25 | 32 | | |
| AC-23A | 230 V | A (kW) | 10.6 (3) | 14 (4) | 19.7 (5.5) | 19.7 (5.5) | | |
| | 240 V | A (kW) | 10.6 (3) | 14 (4) | 19.9 (5.5) | 18.9 (5.5) | | |
| | 400 V | A (kW) | 8.1 (4) | 11 (5.5) | 14.5 (7.5) | 21.8 (11) | | |
| | 415 V | A (kW) | 8.1 (4) | 11 (5.5) | 14 (7.5) | 21 (11) | | |
| | 500 V | A (kW) | 8.9 (5.5) | 11.9 (7.5) | 16.7 (11) | 16.7 (11) | | |
| | 690 V | A (kW) | 8.6 (7.5) | 12.3 (11) | 17.5 (15) | 17.5 (15) | | |
| Rated operational power | | | | | | | | |
| AC-3 | 230/240 V | Hp (kW) | 2 (1.5) | 2 (1.5) | 4 (3) | 4 (3) | 5 (4) | 5 (4) |
| | 400/415 V | Hp (kW) | 4 (3) | 4 (3) | 5 (4) | 5 (4) | 7 (5.5) | 10 (7.5) |
| | 500 V | Hp (kW) | 5 (4) | 5 (4) | 7 (5.5) | 7 (5.5) | 10 (7.5) | 10 (7.5) |
| | 690 V | Hp (kW) | 5 (4) | 7 (5.5) | 7 (5.5) | 10 (7.5) | 15 (11) | 15 (11) |
| Intermittent duty class | 30 | | 30 | | 30 | | 30 | |
| Characteristics in normal operating conditions | | | | | | | | |
| Rated making capacity AC-21A/22A/23A (I rms) | A / 400 V | 120 | 200 | | 250 | | 320 | |
| Rated breaking capacity AC-21A/22A/23A (I rms) | A / 400 V | 120 | 200 | | 200 | | 250 | |
| Short-circuit characteristics | | | | | | | | |
| Permissible ms short time rating (Icw) | A / 400V / 1s | 140 | 300 | 140 | 300 | 300 | 384 | |
| Rated making capacity under short-circuit condition (Icm) I peak | kA / 400 V | 0.5 | 1 | 0.5 | 1 | 1 | 1 | |
| Rated conditional short-circuit current (I rms) | kA / 400 V | 6 | 10 | 6 | 10 | 10 | 10 | |
| with a M/G G fuses | 12 A | | 20 A | | 25 A | | 35 A | |



Manual Motor Control Switches and Disconnects

Mini-Vario and Vario Manual Motor Control Switches

| Switch type | V2 VZ2 | VVD2 VVE2 | V3 VZ3 | VVD3 VVE3 | V4 VZ4 | VVD4 VVE4 | V5 | V6 | VZ7 VZ20 | VZN05 VZN06 | |
|---|---|--------------|-------------|--------------|-------------|--------------|-----------|-----------|-------------|----------------|--|
| Environment | | | | | | | | | | | |
| Conforming to standards | IEC 947-3 | | | | | | | IEC 947-5 | | | |
| Approvals | UL, CSA, GL, UL File # E164864 CCN NLRV, CSA File # LR81630 Class 3211 05 | | | | | | | | | | |
| Protective treatment | "TC" | | | | | | | | | | |
| Degree of protection with protection shroud | IP 20 conforming to IEC 529 | | | | | | | | | | |
| Ambient air temperature | -4 to +122 °F (-20 to +50 °C) | | | | | | | | | | |
| Flame resistance | 960 °C (1760 °F) conforming to IEC 695-2-1 | | | | | | | | | | |
| Shock resistance 1/2 sine wave = 11ms conforming to IEC 60068-2-27 | 30 g | | | | | | | — | | | |
| Vibration resistance 10 to 150 Hz conforming to IEC 60068-2-6 | 1 g | | | | | | | — | | | |
| Electrical characteristics, AC operation | | | | | | | | | | | |
| Rated operational voltage (Ue) | 690 V | 690 V | 690 V | 690 V | 690 V | 690 V | 690 V | 690 V | 690 V | 690 V | |
| Rated impulse withstand voltage (Uimp) | 8 kV | 8 kV | 8 kV | 8 kV | 8 kV | 8 kV | 8 kV | 8 kV | 8 kV | 6 kV | |
| Conventional thermal currents in free air (Ith) and rated uninterrupted (Iu) | 40 A | 63 A | 80 A | 125 A | 175 A | 12 A | 6 A | | | | |
| Conventional thermal current in enclosure (Ithe) | 32 A | 50 A | 63 A | 100 A | 140 A | 10 A | 4 A | | | | |
| Rated operational power and current | | | | | | | | | | | |
| AC-21A/22A | 230 to 690 V | A | 40 | 63 | 80 | 125 | 160 | Ie/AC-15 | Ie/AC-15 | | |
| AC-23A | 230 V | A (kW) | 25.8 (7.5) | 50.3 (15) | 61.2 (18.5) | 71.9 (22) | 96.6 (30) | 6 A | 6 A | | |
| | 240 V | A (kW) | 24.8 (7.5) | 48.2 (15) | 58.5 (18.5) | 68 (22) | 92.7 (30) | 6 A | 6 A | | |
| | 400 V | A (kW) | 29 (15) | 41.5 (22) | 57 (30) | 68.5 (37) | 83 (45) | 4 A | 4 A | | |
| | 415 V | A (kW) | 28 (15) | 40 (22) | 55 (30) | 66 (37) | 80 (45) | 4 A | 4 A | | |
| | 500 V | A (kW) | 28.5 (18.5) | 44 (30) | 54 (37) | 64.5 (45) | 79 (55) | 2 A | 2 A | | |
| | 690 V | A (kW) | 17.5 (15) | 25 (22) | 33 (30) | 42 (37) | 49 (45) | 1 A | 1 A | | |
| Rated operational power | | | | | | | | | | | |
| AC-3 | 230/240 V | Hp (kW) | 7 (5.5) | 14.75 (11) | 20 (15) | 30 (22) | 40 (30) | — | — | | |
| | 400/415 V | Hp (kW) | 14.75 (11) | 24 (18.5) | 30 (22) | 40 (30) | 50 (37) | — | — | | |
| | 500 V | Hp (kW) | 20 (15) | 30 (22) | 40 (30) | 50 (37) | 60 (45) | — | — | | |
| | 690 V | Hp (kW) | 14.75 (11) | 24 (18.5) | 24 (18.5) | 40 (30) | 50 (37) | — | — | | |
| Intermittent duty class | | 30 | 30 | 30 | 30 | 30 | — | — | | | |
| Characteristics in normal operating conditions | | | | | | | | | | | |
| Rated making capacity AC-21A/22A/23A (I rms) | A / 400 V | 400 | 630 | 800 | 1250 | 1750 | — | — | | | |
| Rated breaking capacity AC-21A/22A/23A (I rms) | A / 400 V | 320 | 500 | 640 | 1000 | 1400 | — | — | | | |
| Short-circuit characteristics | | | | | | | | | | | |
| Permissible ms short time rating (Icw) | A / 400 V / 1s | 480 | 756 | 960 | 1500 | 2100 | — | — | | | |
| Rated making capacity under short-circuit condition (Icm) I peak | kA / 400 V | 1 | 2.1 | 2.1 | 2.8 | 2.8 | — | — | | | |
| Rated conditional short-circuit current (I rms) | kA / 400 V | 10 | 10 | 10 | 10 | 10 | 1 | 1 | | | |
| with a M/G G fuses | | 50 A | 63 A | 80 A | 125 A | 200 A | 16 A | 1.6 A | | | |

Manual Motor Control Switches and Disconnects

Mini-Vario and Vario Manual Motor Control Switches

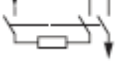
| Switch type | | | VN12 VZN12 | V02 VZ02 | VN20 VZN20 | V01 VZ01 | V0 VZ0 | VVD0 VVE0 | V1 VZ1 | VVD1 VVE1 | |
|---|---|------------------------|---------------|-------------|---------------|-------------|------------|--------------|------------|--------------|--|
| Electrical characteristics, DC operation | | | | | | | | | | | |
| Rated operational current (contacts in series) | | | | | | | | | | | |
|    | 24 V | 1 contact | A | 12 | 20 | 25 | 32 | | | | |
| | | 2 contacts | A | 12 | 20 | 25 | 32 | | | | |
| | | 3 contacts | A | 12 | 20 | 25 | 32 | | | | |
| | 48 V | 1 contact | A | 12 | 20 | 25 | 32 | | | | |
| | | 2 contacts | A | 12 | 20 | 25 | 32 | | | | |
| | | 3 contacts | A | 12 | 20 | 25 | 32 | | | | |
| | 60 V | 1 contact | A | 12 | 20 | 25 | 32 | | | | |
| | | 2 contacts | A | 12 | 20 | 25 | 32 | | | | |
| | | 3 contacts | A | 12 | 20 | 25 | 32 | | | | |
| | 110 V | 1 contact | A | 1.5 | 2 | 9 | 10 | | | | |
| | | 2 contacts | A | 8 | 10 | 12 | 16 | | | | |
| | | 3 contacts | A | 12 | 20 | 25 | 32 | | | | |
| | 220 V | 1 contact | A | 1.5 | 2 | 2.5 | 3 | | | | |
| | | 2 contacts | A | 7 | 8 | 10 | 12 | | | | |
| | | 3 contacts | A | 10 | 14 | 16 | 20 | | | | |
| | 250V | 1 contact | A | 0.6 | 0.7 | 0.8 | 1 | | | | |
| | | 2 contacts | A | 3 | 4 | 6 | 8 | | | | |
| | | 3 contacts | A | 8 | 10 | 12 | 16 | | | | |
| | Rated operational current (contacts in series) | | | | | | | | | | |
| | DC-2 TO DC-5 (L/R = 1ms) | 24 V | 1 contact | A | 12 | 20 | 25 | 32 | | | |
| | | | 2 contacts | A | 12 | 20 | 25 | 32 | | | |
| 3 contacts | | | A | 12 | 20 | 25 | 32 | | | | |
| 48 V | | 1 contact | A | 12 | 20 | 25 | 32 | | | | |
| | | 2 contacts | A | 12 | 20 | 25 | 32 | | | | |
| | | 3 contacts | A | 12 | 20 | 25 | 32 | | | | |
| 60 V | | 1 contact | A | 10 | 14 | 16 | 20 | | | | |
| | | 2 contacts | A | 12 | 20 | 25 | 32 | | | | |
| | | 3 contacts | A | 12 | 20 | 25 | 32 | | | | |
| 110 V | | 1 contact | A | 1.5 | 2 | 2.5 | 3 | | | | |
| | | 2 contacts | A | 3 | 4 | 5 | 6 | | | | |
| | | 3 contacts | A | 12 | 20 | 25 | 32 | | | | |
| 220 V | | 1 contact | A | 0.4 | 0.5 | 0.5 | 0.8 | | | | |
| | | 2 contacts | A | 1.4 | 1.5 | 1.5 | 2 | | | | |
| | | 3 contacts | A | 1 | 2 | 3 | 4 | | | | |
| 250 V | | 1 contact | A | 0.3 | 0.4 | 0.5 | 0.8 | | | | |
| | | 2 contacts | A | 0.4 | 0.6 | 0.8 | 1 | | | | |
| | | 3 contacts | A | 1.2 | 2.4 | 1.6 | 2 | | | | |
| Other characteristics | | | | | | | | | | | |
| Mechanical durability | | millions of op. cycles | 0.05 | 0.1 | 0.05 | 0.1 | 0.1 | 0.1 | 0.1 | 0.1 | |
| Electrical durability in cat. AC-21 | | millions of op. cycles | 0.05 | 0.1 | 0.05 | 0.1 | 0.1 | 0.1 | 0.1 | 0.1 | |
| Electrical durability in cat. DC-1 to 5 | | operating cycles | 30,000 | | 30,000 | | 30,000 | 30,000 | 30,000 | 30,000 | |
| Suitable for isolation | | | yes | | yes | | yes | yes | yes | yes | |
| Cabling | Flexible cable + cable end | AWG (mm ²) | 12 (4) | 10 (6) | 12 (4) | 10 (6) | 10 (6) | 10 (6) | 10 (6) | 10 (6) | |
| | Solid cable | AWG (mm ²) | 12 (4) | 8 (10) | 12 (4) | 8 (10) | 8 (10) | 8 (10) | 8 (10) | 8 (10) | |
| Tightening torque | | lb-in (N•m) | 6.2 (0.7) | 18.6 (2.1) | 6.2 (0.7) | 18.6 (2.1) | 18.6 (2.1) | 18.6 (2.1) | 18.6 (2.1) | 18.6 (2.1) | |

Manual Motor Control Switches and Disconnects Mini-Vario and Vario Manual Motor Control Switches

| Switch type | | | V2 VZ2 | VDD2 VVE2 | V3 VZ3 | VVD3 VVE3 | V4 VZ4 | VVD4 VVE4 | V5 | V6 | VZ7 VZ20 | VZN5 VZN06 | |
|---|--|------------------------|------------------|------------------------|-----------|--------------|------------|--------------|------------|--------------|----------------------------|---------------|------|
| Electrical characteristics, DC operation | | | | | | | | | | | | | |
| Rated operational current (contacts in series) | | | | | | | | | | | | | |
| DC-1 (L/R = 1 ms)  | 24 V | 1 contact | A | 40 | 63 | 80 | 125 | 175 | 175 | 8 (Ie/DC-11) | | | |
| | | 2 contacts | A | 40 | 63 | 80 | 125 | 175 | 175 | — | | | |
| | | 3 contacts | A | 40 | 63 | 80 | 125 | 175 | 175 | — | | | |
| | 48 V | 1 contact | A | 40 | 63 | 80 | 125 | 175 | 175 | 175 | 8 (Ie/DC-11) | | |
| | | 2 contacts | A | 40 | 63 | 80 | 125 | 175 | 175 | — | | | |
| | | 3 contacts | A | 40 | 63 | 80 | 125 | 175 | 175 | — | | | |
| | 60 V | 1 contact | A | 35 | 40 | 50 | 60 | 70 | 70 | 70 | 4 (Ie/DC-11) | | |
| | | 2 contacts | A | 40 | 63 | 80 | 125 | 175 | 175 | — | | | |
| | | 3 contacts | A | 40 | 63 | 80 | 125 | 175 | 175 | — | | | |
| | 110 V | 1 contact | A | 12 | 20 | 25 | 30 | 12 | 12 | 12 | 2 (Ie/DC-11) | | |
| | | 2 contacts | A | 20 | 63 | 80 | 125 | 175 | 175 | — | | | |
| | | 3 contacts | A | 40 | 63 | 80 | 125 | 175 | 175 | — | | | |
| | 220 V | 1 contact | A | 4 | 6 | 8 | 12 | 15 | 15 | 15 | 1 (Ie/DC-11) | | |
| | | 2 contacts | A | 14 | 25 | 30 | 40 | 50 | 50 | — | | | |
| | | 3 contacts | A | 25 | 30 | 40 | 80 | 100 | 100 | — | | | |
| | 250V | 1 contact | A | 2 | 4 | 5 | 6 | 10 | 10 | 10 | 0.8 (Ie/DC-11) | | |
| | | 2 contacts | A | 12 | 20 | 25 | 30 | 40 | 40 | — | | | |
| | | 3 contacts | A | 20 | 30 | 40 | 50 | 61 | 61 | — | | | |
| Rated operational current (contacts in series) | | | | | | | | | | | | | |
| DC-2 TO DC-5 (L/R = 1ms) | 24 V | 1 contact | A | 40 | 63 | 80 | 125 | 175 | 175 | — | | | |
| | | 2 contacts | A | 40 | 63 | 80 | 125 | 175 | 175 | — | | | |
| | | 3 contacts | A | 40 | 63 | 80 | 125 | 175 | 175 | — | | | |
| | 48 V | 1 contact | A | 40 | 63 | 80 | 125 | 175 | 175 | 175 | — | | |
| | | 2 contacts | A | 40 | 63 | 80 | 125 | 175 | 175 | — | | | |
| | | 3 contacts | A | 40 | 63 | 80 | 125 | 175 | 175 | — | | | |
| | 60 V | 1 contact | A | 25 | 40 | 50 | 60 | 70 | 70 | 70 | — | | |
| | | 2 contacts | A | 40 | 63 | 80 | 125 | 175 | 175 | — | | | |
| | | 3 contacts | A | 40 | 63 | 80 | 125 | 175 | 175 | — | | | |
| | 110 V | 1 contact | A | 5 | 6 | 8 | 10 | 12 | 12 | 12 | — | | |
| | | 2 contacts | A | 8 | 10 | 20 | 22 | 24 | 24 | — | | | |
| | | 3 contacts | A | 40 | 50 | 63 | 70 | 80 | 80 | — | | | |
| | 220 V | 1 contact | A | 1 | 1.5 | 2 | 2.2 | 2.4 | 2.4 | 2.4 | — | | |
| | | 2 contacts | A | 3 | 4 | 6 | 7 | 8 | 8 | — | | | |
| | | 3 contacts | A | 7 | 10 | 15 | 16 | 13 | 13 | — | | | |
| | 250 V | 1 contact | A | 1 | 1.2 | 1.5 | 1.6 | 1.8 | 1.8 | 1.8 | — | | |
| | | 2 contacts | A | 2 | 3 | 6 | 7 | 8 | 8 | — | | | |
| | | 3 contacts | A | 6 | 8 | 10 | 12 | 14 | 14 | — | | | |
| | Other characteristics | | | | | | | | | | | | |
| | Mechanical durability | | | millions of op. cycles | 0.1 | 0.03 | 0.03 | 0.03 | 0.03 | 0.03 | 0.03 | 0.1 | 0.05 |
| | Electrical durability in cat. AC-21 | | | millions of op. cycles | 0.1 | 0.03 | 0.03 | 0.03 | 0.03 | 0.03 | 0.03 | 0.1 (AC-15) | 0.05 |
| Electrical durability in cat. DC-1 to 5 | | | operating cycles | 30 K | 30 K | 30 K | 30 K | 30 K | 30 K | 30 K | 30 K (DC-11) | | |
| Suitable for isolation | | | | yes | yes | yes | yes | yes | yes | yes | — | | |
| Cabling | Flexible cable with cable end | AWG (mm ²) | 10 (6) | 6 (16) | 6 (16) | 2/0 (70) | 2/0 (70) | 2/0 (70) | 2/0 (70) | 2/0 (70) | 18 to 16 (2 x 0.75 to 1.5) | | |
| | Solid cable | AWG (mm ²) | 8 (10) | 4 (25) | 4 (25) | 3/0 (95) | 3/0 (95) | 3/0 (95) | 3/0 (95) | 3/0 (95) | 16 to 14 (2 x 1 to 2.5) | | |
| Tightening torque | | | lb-in (N·m) | 18.6 (2.1) | 35.4 (4) | 35.4 (4) | 200 (22.6) | 200 (22.6) | 200 (22.6) | 200 (22.6) | 6.2 (0.7) | | |

Manual Motor Control Switches and Disconnects

Mini-Vario and Vario Manual Motor Control Switches

Selection



VCDN20

- 3-pole rotary manual motor control switches, 10–16 A (UL), 12–20 A (IEC).
- Marking on operator.
- Padlockable operating handle (padlocks not supplied).

Complete Units

Degree of protection IP65, NEMA/UL Type 1 and 12.

Table 1: Main Manual Motor Control Switches for Door Mounting

| Operator Handle | Front Plate in. (mm) | Mounting in. (mm) | Rating (A) | | Catalog Number | Weight lbs (kg) |
|--|------------------------------------|-------------------|------------|-----|----------------|-----------------|
| | | | UL | IEC | | |
| Red, padlockable with up to 3 padlocks | Yellow 2.38 x 2.38 (60 x 60) | Ø 0.88 (22.5) | 10 | 12 | VCDN12 | 0.39 (0.177) |
| | | | 16 | 20 | VCDN20 | 0.39 (0.177) |

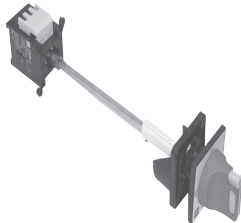

VCCDN20

Table 2: Main Manual Motor Control Switches for Mounting at Back of an Enclosure ¹

| Operator Handle | Front Plate in. (mm) | Mounting in. (mm) | Rating (A) | | Catalog Number | Weight lbs (kg) |
|--|------------------------------------|-------------------|------------|-----|----------------|-----------------|
| | | | UL | IEC | | |
| Red, padlockable with up to 3 padlocks | Yellow 2.38 x 2.38 (60 x 60) | Ø 0.88 (22.5) | 10 | 12 | VCCDN12 | 0.736 (0.334) |
| | | | 16 | 20 | VCCDN20 | 0.736 (0.334) |

¹ Switches supplied with a shaft extension VZN17 and a door interlock plate KZ32 (see page 10).

Table 3: Main Manual Motor Control Switches for Door Mounting

| Operator Handle | Front Plate in. (mm) | Mounting in. (mm) | Rating (A) | | Catalog Number | Weight lbs (kg) |
|--|-----------------------------------|-------------------|------------|-----|----------------|-----------------|
| | | | UL | IEC | | |
| Black, padlockable with up to 3 padlocks | Black 2.38 x 2.38 (60 x 60) | Ø 0.88 (22.5) | 10 | 12 | VBDN12 | 0.39 (0.177) |
| | | | 16 | 20 | VBDN20 | 0.39 (0.177) |



VBDN20

Enclosures

- Degree of protection IP55, non-NEMA.
- Sealable enclosure.

Table 4: Enclosed Main Manual Motor Control Switches ²

| Operator Handle | Front Plate in. (mm) | Rating (A) IEC | Power in AC23 at 400 V Hp (kW) | No. Add-on Modules Possible | Catalog Number | Weight lbs (kg) |
|---|------------------------------------|----------------|--------------------------------|-----------------------------|----------------|-----------------|
| Red, padlockable with: 1 padlock 0.32" (Ø 8 mm) shank or 3 padlocks 0.24" (Ø 6 mm) shank | Yellow 2.38 x 2.38 (60 x 60) | 10 | 5 (4) | 2 | VCFN12GE | 0.93 (0.422) |
| | | 16 | 7 (5.5) | 2 | VCFN20GE | 0.93 (0.422) |

² Enclosure not UL or CSA listed.



VCFN-GE
(Yellow cover with red handle)

Manual Motor Control Switches and Disconnects Mini-Vario and Vario Manual Motor Control Switches

Table 5: Switch Bodies

| Description | Rating (A) | | Catalog Number | Weight lbs (kg) |
|------------------------------------|------------|-----|----------------|-----------------|
| | UL | IEC | | |
| 3-Pole manual motor control switch | 10 | 12 | VN12 | 0.242 (0.110) |
| | 16 | 20 | VN20 | 0.242 (0.110) |



Table 6: Add-on Modules

| Description | Rating (A) | | Catalog Number | Weight lbs (kg) |
|---|---|-----------|----------------|-----------------|
| | UL | IEC | | |
| Main pole module | 10 | 12 | VZN12 | 0.04 (0.020) |
| | 16 | 20 | VZN20 | 0.04 (0.020) |
| Neutral pole module with early make and late break contacts | N/A | 12 and 20 | VZN11 | 0.04 (0.020) |
| Grounding module | N/A | 12 and 20 | VZN14 | 0.035 (0.016) |
| Auxiliary contact block module | 1 N.O. late make contact | | VZN05 | 0.04 (0.020) |
| | 1 N.C. early break contact | | VZN06 | 0.04 (0.020) |
| Input terminal protection shrouds | For add-on pole modules or auxiliary contact block modules (single-pole shroud) | | VZN26 | 0.008 (0.004) |
| | For switch bodies (3-pole switch shroud) | | VZN08 | 0.015 (0.007) |

VN20



VZN11



VZN14



VZN05



VZN26



VZN08

Maximum Number of Add-on Modules that can be attached to a Switch Body

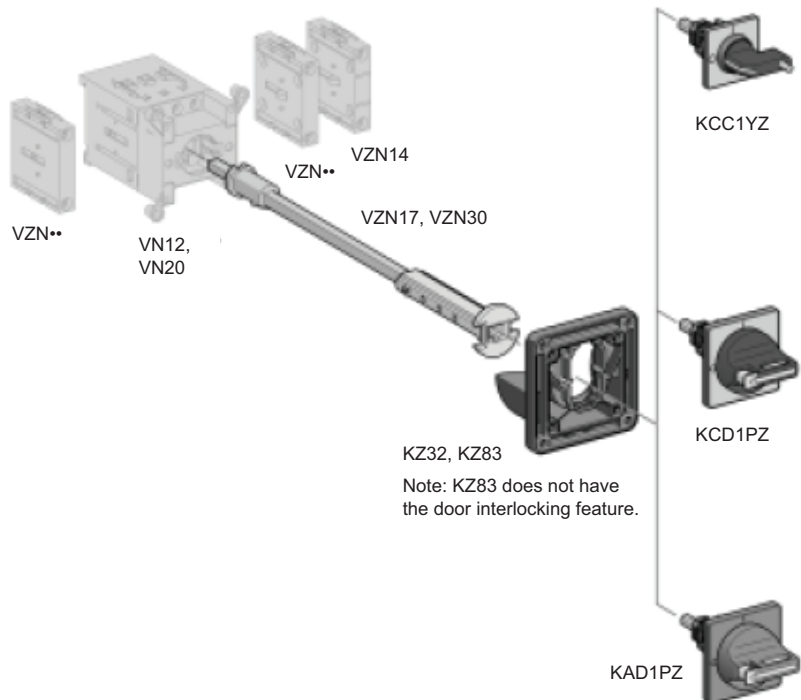
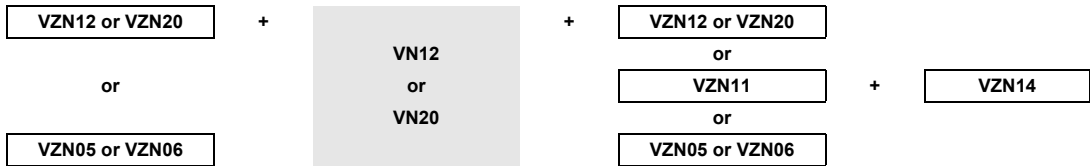

Manual Motor Control Switches and Disconnects

Mini-Vario and Vario Manual Motor Control Switches

- Degree of protection IP65, NEMA/UL Type 1 and 12.
- Marking on operator.
- Padlockable operating handle (padlocks not supplied).
- Operator mounting by 1 \varnothing 0.88 in. (22.5 mm) hole.
- For other accessories and enclosures, see pages 19 and 20.

Table 7: Operators for Main Manual Motor Control Switches

| Operator Handle | Front Plate in. (mm) | Catalog Number | Weight lbs (kg) |
|---|---------------------------------|-------------------|--------------------|
| Red, padlockable with 1 padlock | Yellow 1.75 x 1.75 (45 x 45) | KCC1YZ | 0.11 (0.05) |
| Red, padlockable with up to 3 padlocks | Yellow 2.38 x 2.38 (60 x 60) | KCD1PZ | 0.185 (0.084) |

Table 8: Operators for Main Manual Motor Control Switches

| Operator Handle | Front Plate in. (mm) | Catalog Number | Weight lbs (kg) |
|---|--------------------------------|-------------------|--------------------|
| Black, padlockable with up to 3 padlocks | Black 2.38 x 2.38 (60 x 60) | KAD1PZ | 0.185 (0.084) |

Table 9: Components for Door Interlocking

| For Mounting at the Back of an Enclosure, in Addition to a Direct Operator | | | | | |
|--|--|--------------------------------|---------------------|-------------------|--------------------|
| Description | Front Plate in. (mm) | Enclosure Depth in. (mm) | Package Quantity | Catalog Number | Weight lbs (kg) |
| Shaft extension | — | 11.88 to 13.38 (300 to 340) | 1 | VZN17 | 0.22 (0.100) |
| | | 15.75 to 17 (400 to 430) | 1 | VZN30 | 0.286 (0.130) |
| Door interlock plate | 1.75 x 1.75 (45 x 45) or 2.38 x 2.38 (60 x 60) | — | 5 | KZ32 | 0.375 (0.170) |
| Plate for door mounting | 1.75 x 1.75 (45 x 45) or 2.38 x 2.38 (60 x 60) | — | 5 | KZ83 | 0.451 (0.205) |

Manual Motor Control Switches and Disconnects Mini-Vario and Vario Manual Motor Control Switches

- 3-pole rotary manual motor control switches: 10 to 115 A (UL), 12 to 175 A (IEC).
- Marking on operator.
- Padlockable operating handle (padlocks not supplied).
- Degree of protection IP65, NEMA/UL Type 1 and 12.

Table 10: Main Manual Motor Control Switches for Door Mounting



VCF0

| Operator Handle | Front Plate in. (mm) | Mounting in. (mm) | Rating (A) | | Catalog Number | Weight lbs (kg) |
|--|------------------------------------|-------------------|------------|-----|----------------|-----------------|
| | | | UL | IEC | | |
| Red, padlockable with up to 3 padlocks | Yellow 2.38 x 2.38 (60 x 60) | Ø 0.88 (22.5) | 10 | 12 | VCD02 | 0.474 (0.215) |
| | | | 16 | 20 | VCD01 | 0.474 (0.215) |
| | | | 20 | 25 | VCD0 | 0.474 (0.215) |
| | | | 20 | 32 | VCD1 | 0.474 (0.215) |
| | | | 25 | 40 | VCD2 | 0.474 (0.215) |
| | | 4 screws | 10 | 12 | VCF02 | 0.55 (0.25) |
| | | | 16 | 20 | VCF01 | 0.55 (0.25) |
| | | | 20 | 25 | VCF0 | 0.55 (0.25) |
| | | | 20 | 32 | VCF1 | 0.55 (0.25) |
| | | | 25 | 40 | VCF2 | 0.55 (0.25) |
| Red, long, padlockable with up to 3 padlocks | Yellow 3.5 x 3.5 (90 x 90) | 4 screws | 45 | 63 | VCF3 | 1.234 (0.560) |
| | | | 63 | 80 | VCF4 | 1.234 (0.560) |
| | | | 100 | 125 | VCF5 | 2.644 (1.200) |
| | | | 115 | 175 | VCF6 | 2.644 (1.200) |

Table 11: Main Manual Motor Control Switches for Mounting at Back of an Enclosure ¹

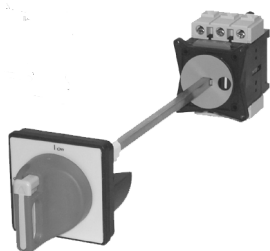

VCCF0

| Operator Handle | Front Plate in. (mm) | Mounting in. (mm) | Rating (A) | | Catalog Number | Weight lbs (kg) |
|--|------------------------------------|-------------------|------------|-----|----------------|-----------------|
| | | | UL | IEC | | |
| Red, padlockable with up to 3 padlocks | Yellow 2.38 x 2.38 (60 x 60) | Ø 0.88 (22.5) | 10 | 12 | VCCD02 | 0.864 (0.392) |
| | | | 16 | 20 | VCCD01 | 0.864 (0.392) |
| | | | 20 | 25 | VCCD0 | 0.864 (0.392) |
| | | | 20 | 32 | VCCD1 | 0.864 (0.392) |
| | | | 25 | 40 | VCCD2 | 0.864 (0.392) |
| | | 4 screws | 10 | 12 | VCCF02 | 1.615 (0.527) |
| | | | 16 | 20 | VCCF01 | 1.615 (0.527) |
| | | | 20 | 25 | VCCF0 | 1.615 (0.527) |
| | | | 20 | 32 | VCCF1 | 1.615 (0.527) |
| | | | 25 | 40 | VCCF2 | 1.615 (0.527) |
| Red, long, padlockable with up to 3 padlocks | Yellow 3.5 x 3.5 (90 x 90) | 4 screws | 45 | 63 | VCCF3 | 0.969 (0.440) |
| | | | 63 | 80 | VCCF4 | 1.498 (0.680) |
| | | | 100 | 125 | VCCF5 | 2.909 (1.320) |
| | | | 115 | 175 | VCCF6 | 2.909 (1.320) |

¹ Unit supplied with a shaft extension VZ17 and a door interlock plate KZ32 or KZ74, see page 10.

Manual Motor Control Switches and Disconnects

Mini-Vario and Vario Manual Motor Control Switches



VBD0

- 3-pole rotary manual motor control switches: 10–115 A (UL), 12–175 A (IEC).
- Marking on operator.
- Padlockable operating handle (padlocks not supplied).
- Degree of protection IP65, NEMA/UL Type 1 and 12.

Table 12: Main Manual Motor Control Switches for Door Mounting

| Operator Handle | Front Plate in. (mm) | Mounting in. (mm) | Rating (A) | | Catalog Number | Weight lbs (kg) |
|--|-----------------------------|-------------------|------------|-----|----------------|-----------------|
| | | | UL | IEC | | |
| Black, padlockable with up to 3 padlocks | Black 2.38 x 2.38 (60 x 60) | ∅ 0.88 (22.5) | 10 | 12 | VBD02 | 0.474 (0.215) |
| | | | 16 | 20 | VBD01 | 0.474 (0.215) |
| | | | 20 | 25 | VBD0 | 0.474 (0.215) |
| | | | 20 | 32 | VBD1 | 0.474 (0.215) |
| | | | 25 | 40 | VBD2 | 0.474 (0.215) |
| | | 4 screws | 10 | 12 | VBF02 | 0.55 (0.250) |
| | | | 16 | 20 | VBF01 | 0.55 (0.250) |
| | | | 20 | 25 | VBF0 | 0.55 (0.250) |
| | | | 20 | 32 | VBF1 | 0.55 (0.250) |
| | | | 25 | 40 | VBF2 | 0.55 (0.250) |
| Black, long, padlockable with up to 3 padlocks | Black 3.5 x 3.5 (90 x 90) | 4 screws | 45 | 63 | VBF3 | 1.234 (0.560) |
| | | | 63 | 80 | VBF4 | 1.234 (0.560) |
| | | | 100 | 125 | VBF5 | 2.644 (1.200) |
| | | | 115 | 175 | VBF6 | 2.644 (1.200) |



VBF5

Table 13: Main Manual Motor Control Switches

| For Mounting in an Enclosure or for Modular Distribution Boards | | | | | |
|---|------------------------------|------------|-----|----------------|-----------------|
| Operator Handle | Front Plate in. (mm) | Rating (A) | | Catalog Number | Weight lbs (kg) |
| | | UL | IEC | | |
| Red, padlockable with 1 padlock | Yellow 1.75 x 1.75 (45 x 45) | 20 | 25 | VVE0 | 0.55 (0.250) |
| | | 20 | 32 | VVE1 | 0.55 (0.250) |
| | | 25 | 40 | VVE2 | 0.55 (0.250) |
| | | 45 | 63 | VVE3 | 1.168 (0.530) |
| | | 63 | 80 | VVE4 | 1.168 (0.530) |



VVE1

Table 14: Main Manual Motor Control Switches

| For Mounting in an Enclosure or for Modular Distribution Boards | | | | | |
|---|-----------------------------|------------|-----|----------------|-----------------|
| Operator Handle | Front Plate in. (mm) | Rating (A) | | Catalog Number | Weight lbs (kg) |
| | | UL | IEC | | |
| Black, not padlockable | Black 1.75 x 1.75 (45 x 45) | 20 | 25 | VVD0 | 0.55 (0.250) |
| | | 20 | 32 | VVD1 | 0.55 (0.250) |
| | | 25 | 40 | VVD2 | 0.55 (0.250) |
| | | 45 | 63 | VVD3 | 1.234 (0.560) |
| | | 63 | 80 | VVD4 | 1.234 (0.560) |

Manual Motor Control Switches and Disconnects Mini-Vario and Vario Manual Motor Control Switches



Non-Metallic Enclosure

- 3-pole rotary manual motor control switches, 12 to 175 A.
- Marking on operator.
- Degree of protection IP55, NEMA Type, as noted.
- Handles are padlockable.

Non-Metallic Enclosures

The Vario manual motor control switch is also offered as an enclosed switch. The 3-pole version makes the Vario manual motor control switch ideal for manual motor control applications. They are compact, easy to wire and connect, and come undrilled to allow variable cable entry positions.

Table 15: Enclosure Rated NEMA/UL Type 1 and 12

| Rating (A) | | Horsepower Ratings Hp (kW) | | | | IP55-PVC 3-Pole |
|------------|-----|----------------------------|---------|----------|---------|-----------------|
| UL | IEC | 208 V | 240 V | 480 V | 600 V | Catalog Number |
| 20 | 32 | 5 (4) | 5 (4) | 10 (7) | 10 (7) | VC1GUN |
| 25 | 40 | 7.5 (6) | 7.5 (6) | 15 (11) | 20 (15) | VC2GUN |
| 45 | 63 | 15 (11) | 15 (11) | 30 (2.2) | 40 (30) | VC3GUN |
| 63 | 80 | 15 (11) | 20 (15) | 40 (30) | 50 (37) | VC4GUN |
| 100 | 125 | 20 (15) | 25 (19) | 50 (37) | 60 (45) | VC5GUN |
| 115 | 175 | 25 (19) | 30 (22) | 60 (45) | 75 (56) | VC6GUN |



Metallic Enclosure

Metallic Enclosures

The V1 and V2 come in metallic enclosures (NEMA/UL Type 1, 4, 4X, and 12). The NEMA/UL Type 1 is supplied with conduit knockouts top and bottom. A VZ7 auxiliary contact can be factory installed in these metallic enclosures by adding Form X11 to the catalog number. A VZ20 auxiliary contact can be factory installed in these enclosures by adding Form X20 to the catalog number.



VCF0GE

Table 16: Enclosure Rated NEMA/UL Type 1, 12, and 4/4X

| Rating (A) | | Horsepower Ratings Hp (kW) | | | NEMA/UL Type 1 | NEMA/UL Type 12 | NEMA/UL Type 4/4X ¹ |
|------------|-----|----------------------------|---------|---------|------------------|------------------|--------------------------------|
| UL | IEC | 240 V | 480 V | 600 V | Catalog Number | Catalog Number | Catalog Number |
| 20 | 32 | 5 (4) | 10 (7) | 10 (7) | 9421V1G30 | 9421V1A30 | 9421V1W30 |
| 25 | 40 | 7.5 (6) | 15 (11) | 20 (15) | 9421V2G30 | 9421V2A30 | 9421V2W30 |

¹ For indoor use only. The NEMA/UL Type 4/4X enclosure is made of #304 stainless steel with 3/4 in. T&B stainless steel hubs on the top and bottom.



VCF3GE

Table 17: Enclosed 3-Pole Main Manual Motor Control Switches

| Operator Handle | Front Plate Dimensions in. (mm) | Rating (A) IEC | Power in AC 23 at 400 V kW | No. Add-on Modules Possible ¹ | Catalog Number ² | Weight lbs (kg) |
|--|---------------------------------|----------------|----------------------------|--|-----------------------------|-----------------|
| Red, padlockable with up to 3 padlocks | Yellow 2.38 x 2.38 (60 x 60) | 10 | 4 | 2 | VCF02GE | 1.102 (0.500) |
| | | 16 | 5.5 | 2 | VCF01GE | 1.102 (0.500) |
| | | 20 | 7.5 | 2 | VCF0GE | 1.102 (0.500) |
| | | 25 | 11 | 2 | VCF1GE | 1.102 (0.500) |
| | | 32 | 15 | 2 | VCF2GE | 1.102 (0.500) |
| | | 50 | 22 | 3 | VCF3GE | 2.049 (0.930) |
| | | 63 | 30 | 3 | VCF4GE | 2.049 (0.930) |

Continued on next page



VBF0GE

Manual Motor Control Switches and Disconnects

Mini-Vario and Vario Manual Motor Control Switches

Table 17: Enclosed 3-Pole Main Manual Motor Control Switches *(continued)*

| Operator Handle | Front Plate Dimensions in. (mm) | Rating (A) IEC | Power in AC 23 at 400 V kW | No. Add-on Modules Possible ¹ | Catalog Number ² | Weight lbs (kg) |
|--|------------------------------------|----------------|----------------------------|--|-----------------------------|-----------------|
| Black, padlockable with up to 3 padlocks | Yellow 2.38 x 2.38 (60 x 60) | 10 | 4 | 2 | VBF02GE | 1.102 (0.500) |
| | | 16 | 5.5 | 2 | VBF01GE | 1.102 (0.500) |
| | | 20 | 7.5 | 2 | VBF0GE | 1.102 (0.500) |
| | | 25 | 11 | 2 | VBF1GE | 1.102 (0.500) |
| | | 32 | 15 | 2 | VBF2GE | 1.102 (0.500) |
| | | 50 | 22 | 3 | VBF3GE | 2.049 (0.930) |
| | | 63 | 30 | 3 | VBF4GE | 2.049 (0.930) |
| Black, long, padlockable with up to 3 padlocks | Yellow 3.5 x 3.5 (90 x 90) | 100 | 37 | 4 | VBF5GE | 4.827 (2.190) |
| | | 140 | 45 | 4 | VBF6GE | 4.827 (2.190) |

¹ Refer to the chart on page 15.

² Enclosures are not UL or CSA listed.

Manual Motor Control Switches and Disconnects Mini-Vario and Vario Manual Motor Control Switches

Table 18: Switch Bodies and Add-on Modules

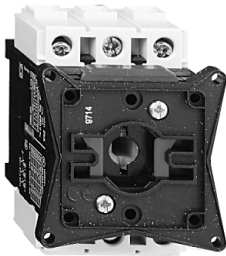

V0



V5

| Switch Bodies | | | | |
|--|------------|--------------------------|----------------|-----------------|
| Description | Rating (A) | | Catalog Number | Weight lbs (kg) |
| | UL | IEC | | |
| 3-pole manual motor control switches ¹ | 10 | 12 | V02 | 0.44 (0.200) |
| | 16 | 20 | V01 | 0.44 (0.200) |
| | 20 | 25 | V0 | 0.44 (0.200) |
| | 20 | 32 | V1 | 0.44 (0.200) |
| | 25 | 40 | V2 | 0.44 (0.200) |
| | 45 | 63 | V3 | 1.102 (0.500) |
| | 63 | 80 | V4 | 1.102 (0.500) |
| | 100 | 125 | V5 | 1.983 (0.900) |
| | 115 | 175 | V6 | 1.983 (0.900) |
| Add-on modules | | | | |
| Main pole module | 10 | 12 | VZ02 | 0.11 (0.050) |
| | 16 | 20 | VZ01 | 0.11 (0.050) |
| | 20 | 25 | VZ0 | 0.11 (0.050) |
| | 20 | 32 | VZ1 | 0.11 (0.050) |
| | 25 | 40 | VZ2 | 0.11 (0.050) |
| | 45 | 63 | VZ3 | 0.22 (0.100) |
| | 63 | 80 | VZ4 | 0.22 (0.100) |
| Neutral pole module with early make and late break contacts ¹ | N/A | 12 to 40 | VZ11 | 0.11 (0.050) |
| | | 63 and 80 | VZ12 | 0.22 (0.100) |
| | | 125 and 175 | VZ13 | 0.55 (0.250) |
| Grounding module | N/A | 12 to 40 | VZ14 | 0.11 (0.050) |
| | | 63 and 80 | VZ15 | 0.22 (0.100) |
| | | 125 and 175 | VZ16 | 0.55 (0.250) |
| | | N.O. + N.C. ² | VZ7 | 0.11 (0.050) |
| Auxiliary contact block module with 2 auxiliary contacts | — | N.C. + N.O. | VZ20 | 0.11 (0.050) |

¹ Protection shrouds are available if required. See Table 21 on page 19.

² Late make N.O., early break N.C. contacts.

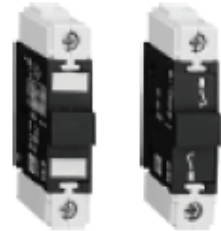

VZ0

VZ11

Maximum Number of Add-on Modules that can be attached to a Switch Body

One (1) add-on module on each side of the switch body:

| | | | | | | | | | | |
|-----------------|---|-----|---|-----------------|--|------|---|----|---|------|
| VZ7 or VZ20 | + | V0* | + | VZ7 or VZ20 | | VZ7 | + | V5 | + | VZ7 |
| or | | | | or | | or | | | | or |
| VZ11 or VZ12 | + | V0 | + | VZ11 or VZ12 | | VZ20 | + | or | + | VZ20 |
| or | | | | or | | or | | or | | or |
| VZ14 or VZ15 | + | to | + | VZ14 or VZ15 | | VZ13 | + | or | + | VZ13 |
| or | | | | or | | or | | V6 | | or |
| VZ0*/VZ0 to VZ4 | + | V4 | + | VZ0*/VZ0 to VZ4 | | VZ16 | + | | + | VZ16 |

Two (2) add-on modules on each side of the switch body:

| | | | | | | | | | | | | | | |
|------|---|------|---|-----|---|------|---|-----|----|------|----|------|----|------|
| VZ0* | + | VZ0* | + | V0* | + | VZ0* | + | VZ7 | or | VZ20 | or | VZ11 | or | VZ14 |
| VZ0 | + | VZ0 | + | V0 | + | VZ0 | + | VZ7 | or | VZ20 | or | VZ11 | or | VZ14 |
| VZ1 | + | VZ1 | + | V1 | + | VZ1 | + | VZ7 | or | VZ20 | or | VZ11 | or | VZ14 |
| VZ2 | + | VZ2 | + | V2 | + | VZ2 | + | VZ7 | or | VZ20 | or | VZ11 | or | VZ14 |
| VZ3 | + | VZ3 | + | V3 | + | VZ3 | + | VZ7 | or | VZ20 | or | VZ12 | or | VZ15 |
| VZ4 | + | VZ4 | + | V4 | + | VZ4 | + | VZ7 | or | VZ20 | or | VZ12 | or | VZ15 |

NOTE: The add-on modules mounted next to the switch body are main poles. Maximum of 3 main poles per switch body.



VZ15

VZ20

Manual Motor Control Switches and Disconnects

Mini-Vario and Vario Manual Motor Control Switches

Non-Padlockable Handles

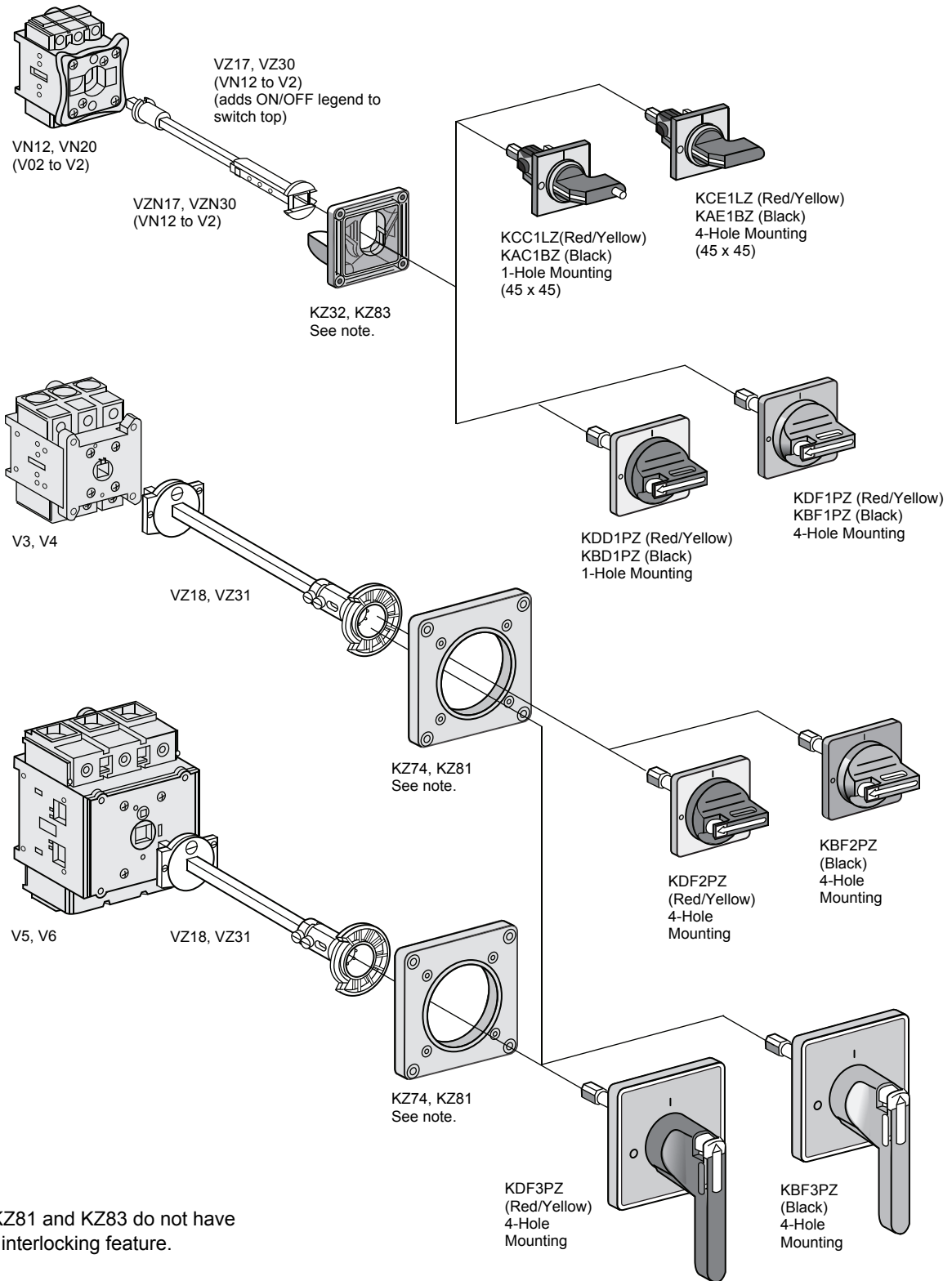

NOTE: KZ81 and KZ83 do not have the door interlocking feature.

Manual Motor Control Switches and Disconnects Mini-Vario and Vario Manual Motor Control Switches

- Marking on operator.
- Degree of protection IP65, NEMA/UL Type 1 and 12.

Table 19: Handles and Front Plates for Main Manual Motor Control Switches (not padlockable)

| For Switch Body | Operator Handle | Front Plate Dimensions in. (mm) | Mounting in. (mm) | Catalog Number | Weight lbs (kg) |
|-------------------------|------------------------------|------------------------------------|-------------------|----------------------------|-----------------|
| VN12, VN20 V02 to V2 | Red not padlockable | Yellow 1.75 x 1.75 (45 x 45) | ∅ 0.88 (22.5) | KCC1LZ | 0.11 (0.050) |
| | | | 4 screws | KCE1LZ | 0.088 (0.040) |
| | Black not padlockable | Yellow 2.38 x 2.38 (60 x 60) | ∅ 0.88 (22.5) | KDD1PZ | 0.181 (0.082) |
| | | | 4 screws | KDF1PZ | 0.165 (0.075) |
| | | Black 1.75 x 1.75 (45 x 45) | ∅ 0.88 (22.5) | KAC1BZ | 0.11 (0.050) |
| | | | 4 screws | KAE1BZ | 0.088 (0.040) |
| V3 and V4 | Red, long not padlockable | Yellow 2.38 x 2.38 (60 x 60) | 4 screws | KDF2PZ | 0.154 (0.070) |
| | Black not padlockable | Black 2.38 x 2.38 (60 x 60) | | KBF2PZ | |
| V5 and V6 | Red, long not padlockable | Yellow 3.5 x 3.5 (90 x 90) | 4 screws | KDF3PZ ¹ | 0.353 (0.160) |
| | Black not padlockable | Black 3.5 x 3.5 (90 x 90) | | KBF3PZ ¹ | |

¹ For door mounting 63 A and 80 A manual motor control switches, adapter plate KZ106 must be ordered separately. See page 20.

Manual Motor Control Switches and Disconnects

Mini-Vario and Vario Manual Motor Control Switches

Padlockable Handles

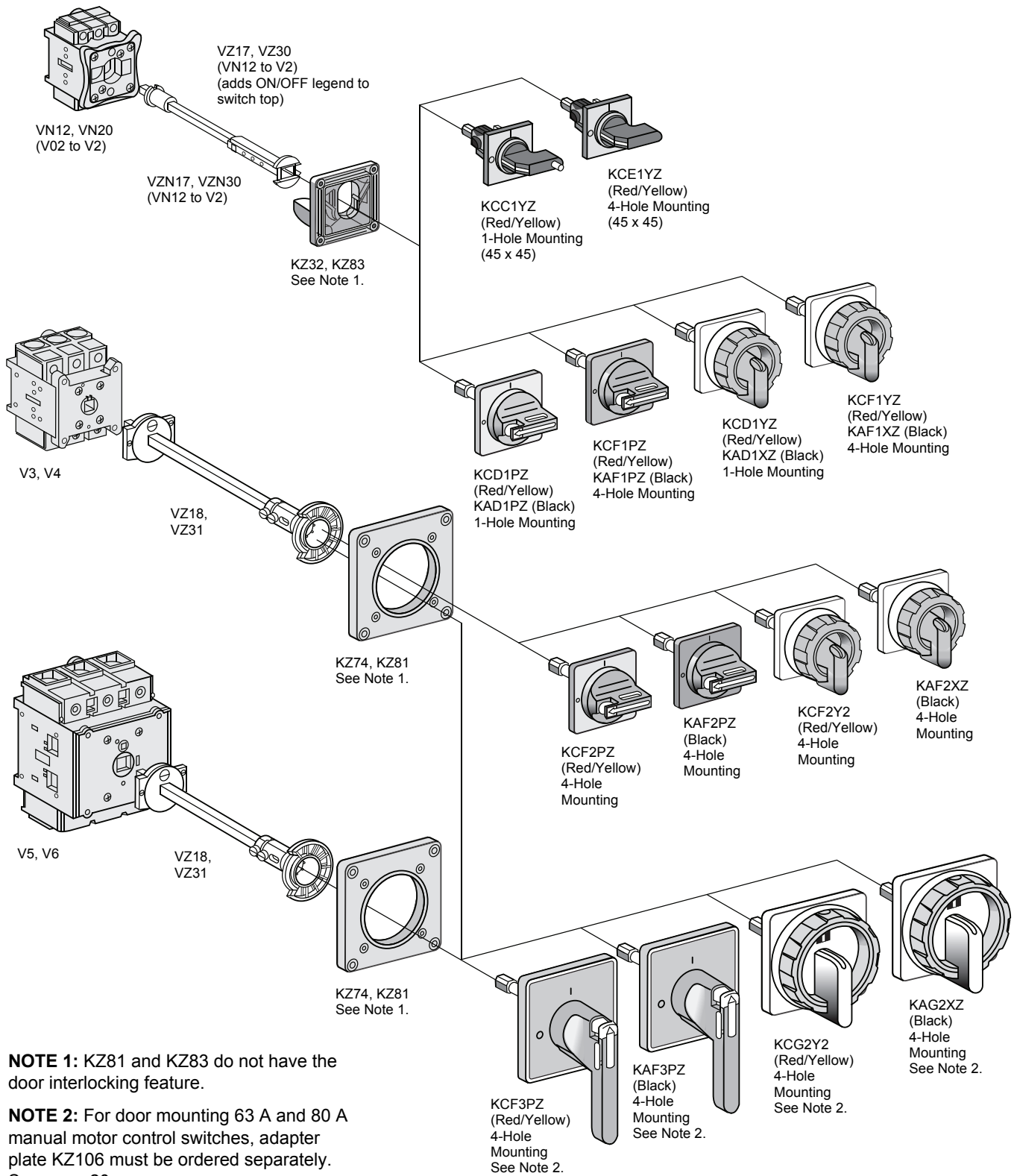

NOTE 1: KZ81 and KZ83 do not have the door interlocking feature.

NOTE 2: For door mounting 63 A and 80 A manual motor control switches, adapter plate KZ106 must be ordered separately. See page 20.

Manual Motor Control Switches and Disconnects Mini-Vario and Vario Manual Motor Control Switches

- Marking on operator.
- Padlockable operating handle (padlocks not supplied).
- Degree of protection IP65, NEMA/UL Type 1 and 12.

Table 20: Handles and Front Plates for Main Manual Motor Control Switches



KCF2YZ



KCF2PZ

| For Switch Body | Operator Handle | Front Plate Dimensions in. (mm) | Mounting in. (mm) | Catalog Number | Weight lbs (kg) |
|-------------------------|---|------------------------------------|-------------------|------------------------------------|-----------------|
| VN12, VN20 V02 to V2 | Red padlockable with 1 padlock | Yellow 1.75 x 1.75 (45 x 45) | Ø 0.88 (22.5) | KCC1YZ | 0.11 (0.050) |
| | | | 4 screws | KCE1YZ | 0.088 (0.040) |
| | Red padlockable with up to 3 padlocks | Yellow 2.38 x 2.38 (60 x 60) | Ø 0.88 (22.5) | KCD1PZ KCD1YZ | 0.181 (0.082) |
| | | | 4 screws | KCF1PZ KCF1YZ 1 | 0.165 (0.075) |
| | Black padlockable with up to 3 padlocks | Black 2.38 x 2.38 (60 x 60) | Ø 0.88 (22.5) | KAD1PZ KAD1XZ 1 | 0.181 (0.082) |
| | | | 4 screws | KAF1PZ KAF1XZ 1 | 0.165 (0.075) |
| V3 and V4 | Red padlockable with up to 3 padlocks | Yellow 2.38 x 2.38 (60 x 60) | 4 screws | KCF2PZ KCF2YZ 1 | 0.154 (0.070) |
| | Black padlockable with up to 3 padlocks | Black 2.38 x 2.38 (60 x 60) | | KAF2PZ KAF2XZ 1 | |
| V5 and V6 | Red, long padlockable with up to 3 padlocks | Yellow 3.5 x 3.5 (90 x 90) | 4 screws | KCF3PZ 2 KCG2YZ 1 | 0.353 (0.160) |
| | Black, long padlockable with up to 3 padlocks | Black 3.5 x 3.5 (90 x 90) | | KAF3PZ 2 KAG2XZ 1 | |

¹ Similar in style to KCF2YZ.

² For door mounting 63 A and 80 A manual motor control switches, adapter plate KZ106 must be ordered separately. See page 20.



VZ8



VZ26

Table 21: Input Terminal Protection Shrouds

| Description | For Use With | Catalog Number | Weight lbs (kg) |
|--|-------------------------|----------------|-----------------|
| For switch bodies (3-pole shroud) | V02 to V2 | VZ8 | 0.033 (0.015) |
| | V3 and V4 | VZ9 | 0.044 (0.020) |
| | V5 and V6 | VZ10 | 0.132 (0.060) |
| For add-on pole modules (single-pole shroud) | VZ02 to VZ2, VZ11, VZ14 | VZ26 | 0.011 (0.005) |
| | VZ3, VZ4, VZ12, VZ15 | VZ27 | 0.015 (0.007) |
| | VZ13, VZ16 | VZ28 | 0.044 (0.020) |
| For contact blocks with 2 auxiliary contacts | — | VZ29 | 0.011 (0.005) |

Manual Motor Control Switches and Disconnects

Mini-Vario and Vario Manual Motor Control Switches

Table 22: Components for Door Interlocking









| For Mounting at the Back of an Enclosure, in Addition to a Direct Operator | | | | | | |
|--|-------------------------|---|---------------------------|----------------|-----------------|---------------|
| Description | For Use With | Front Plate Dimensions in. (mm) | Standard Package Quantity | Catalog Number | Weight lbs (kg) | |
|  <p>VZ18</p>  <p>KZ32</p>  <p>KZ81</p>  <p>KZ106</p> | VN12, VN20 V02 to V2 | 11.81 x 12.99 (300 to 330) | 1 | VZN17 | 0.22 (0.100) | |
| | | 15.75 x 16.93 (400 to 430) | 1 | VZN30 | 0.286 (0.130) | |
| | V02 to V2 | 11.81 x 12.99 (300 to 330) | 1 | VZ17 | 0.165 (0.075) | |
| | | 15.75 x 16.93 (400 to 430) | 1 | VZ30 | 0.275 (0.125) | |
| | V3 and V4 | 11.81 x 12.60 (300 to 320) | 1 | VZ18 | 0.375 (0.170) | |
| | | 15.75 x 16.54 (400 to 420) | 1 | VZ31 | 0.474 (0.215) | |
| | V5 and V6 | 11.81 x 13.78 (300 to 350) | 1 | VZ18 | 0.375 (0.170) | |
| | | 16.93 x 17.72 (430 to 450) | 1 | VZ31 | 0.474 (0.215) | |
| | Door interlock plate | VN12, VN20 V02 to V2 | — | 5 | KZ32 | 0.390 (0.177) |
| | | V3 to V6 | — | 5 | KZ74 | 0.044 (0.020) |
| Plates for door mounting handles with 4 screw mounting (do not interlock with door) | VN12, VN20 V02 to V2 | 1.75 x 1.75 (45 x 45) or 2.38 x 2.38 (60 x 60) | 5 | KZ83 | 0.452 (0.205) | |
| | V3 and V4 | 2.38 x 2.38 (60 x 60) | 5 | KZ81 | 0.022 (0.010) | |
| | V3 to V6 | 3.5 x 3.5 (90 x 90) | 5 | KZ81 | 0.022 (0.010) | |
| Adaptor plate for manual motor control switches | V3 and V4 | 3.5 x 3.5 (90 x 90) | 5 | KZ106 | 0.165 (0.075) | |

Table 23: Accessories for Operators

| Description | For Use With | Front Plate Dimensions in. (mm) | Standard Package Quantity | Catalog Number | Weight lbs (kg) |
|---|--|---------------------------------|---------------------------|----------------|-----------------|
|  <p>KZ13</p> | front plate | 1.75 x 1.75 (45 x 45) | 5 | KZ13 | 0.132 (0.060) |
| | | 2.38 x 2.38 (60 x 60) | 5 | KZ15 | 0.143 (0.065) |
| | | 3.5 x 3.5 (90 x 90) | 5 | KZ103 | 0.154 (0.070) |
|  <p>KZ14</p> | front plate | 1.75 x 1.75 (45 x 45) | 20 | KZ14 | 0.132 (0.060) |
| | | 2.38 x 2.38 (60 x 60) | 10 | KZ16 | 0.143 (0.065) |
| | | 3.5 x 3.5 (90 x 90) | 5 | KZ101 | 0.154 (0.070) |
|  <p>KZ76</p> | KZ14 | — | 20 | KZ76 | 0.044 (0.020) |
| | KZ16 | — | 10 | KZ77 | 0.022 (0.010) |
| | KZ101 | — | 5 | KZ100 | 0.011 (0.005) |
|  <p>Z01</p> | VN12, VN20 V02 to V2 | 1.75 x 1.75 (45 x 45) | 5 | KZ65 | 0.081 (0.037) |
| | | 2.38 x 2.38 (60 x 60) | 5 | KZ66 | 0.073 (0.033) |
| | V3 and V4 | 2.38 x 2.38 (60 x 60) | 5 | KZ62 | 0.073 (0.033) |
| Tightening tool | V3 to V6 | 3.5 x 3.5 (90 x 90) | 5 | KZ67 | 0.140 (0.064) |
| | operators with Ø 7/8 in. (22.5 mm) mounting | — | 5 | Z01 | 0.110 (0.050) |

Manual Motor Control Switches and Disconnects Mini-Vario and Vario Manual Motor Control Switches

Manual Motor Control Switch Bodies

VN12 and VN20

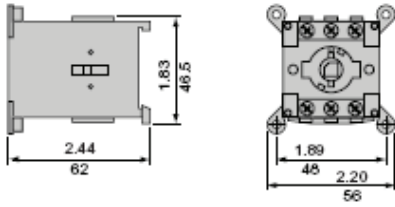

Add-on modules VZN12 and VZN20

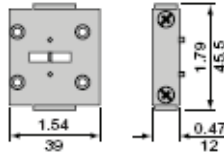

VZN11, VZN14 VZN05, and VZN06

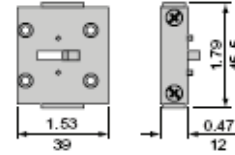

Manual Motor Control Switch Mounted on Enclosure Door VN12 and VN20

Four-hole mounting

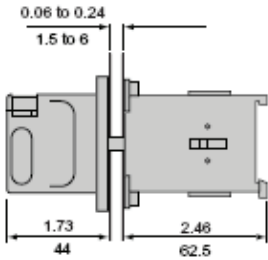

Single-hole mounting

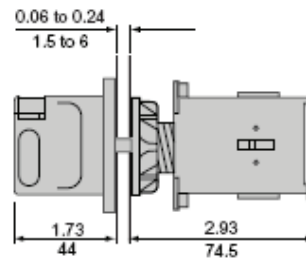

1.75 in. x 1.75 in. front plate (45 mm x 45 mm)

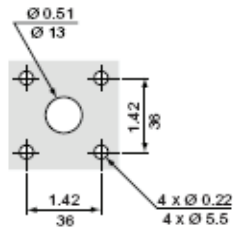

2.38 in. x 2.38 in. front plate (60 mm x 60 mm)

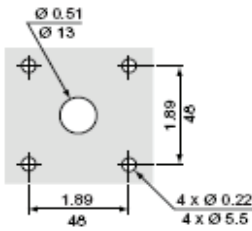

Single-hole mounting

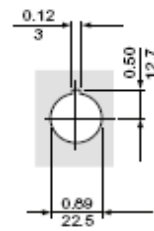

Dimensions: $\frac{\text{in.}}{\text{mm}}$

Manual Motor Control Switches and Disconnects

Mini-Vario and Vario Manual Motor Control Switches

Manual Motor Control Switch Mounted at Back of Enclosure with Shaft Extension VZN17 or VZN30 (clip-on mounting on DIN rail) VN12, VN20

Four-hole mounting

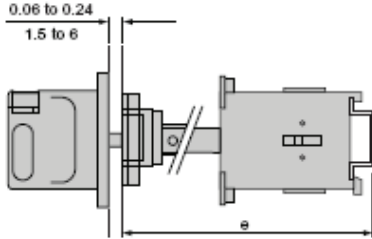

Single-hole mounting

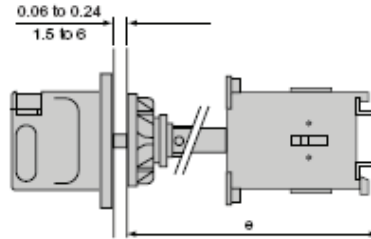

| | Shaft Extension | Distance (e) Enclosure Depth in. (mm) |
|------------|-----------------|---|
| VN12, VN20 | VZN17 | 11.81 to 12.99 (300 to 330) |
| | VZN30 | 15.75 to 16.93 (400 to 430) |

V•FN12GE and V•FN20GE (Enclosures not UL or CSA Listed)

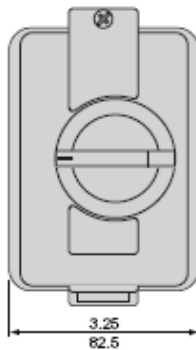
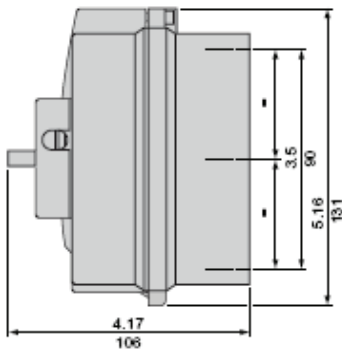

Dimensions: $\frac{\text{in.}}{\text{mm}}$

Wiring Diagrams

Switch body
VN12 and VN20

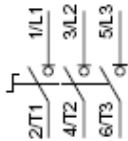

Main pole module
VZN12 and VZN20



Neutral pole module
VZN11



Auxiliary contact blocks
VZN05 VZN06



Manual Motor Control Switches and Disconnects Mini-Vario and Vario Manual Motor Control Switches

Switch Bodies

V01, V0 to V2

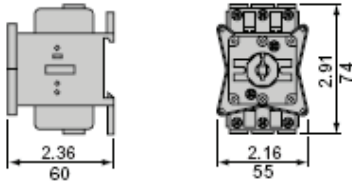

VZ02 to VZ4, VZ11 to VZ16

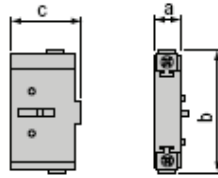

VZ7, VZ20

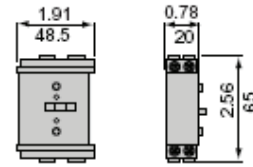

| | in. (mm) | in. (mm) | in. (mm) |
|---------------------------------------|-----------|------------|-----------|
| | a | b | c |
| VZ02 and VZ01, VZ0 to VZ2, VZ11, VZ14 | 0.63 (16) | 2.9 (74) | 1.38 (35) |
| VZ3, VZ4, VZ12, VZ15 | 0.79 (20) | 3.27 (83) | 1.81 (46) |
| VZ13, VZ16 | 1.18 (30) | 4.92 (125) | 2.48 (63) |

V3 to V6

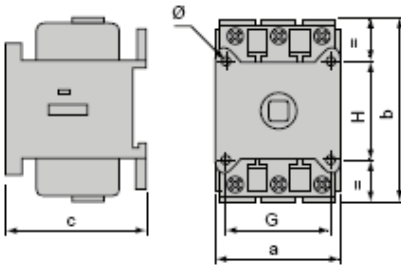

| | in. (mm) | in. (mm) | in. (mm) | in. (mm) | in. (mm) | in. (mm) |
|--------|-----------|------------|-----------|-----------|-----------|------------|
| | a | b | c | G | H | Ø |
| V3, V4 | 2.36 (60) | 3.27 (83) | 2.56 (65) | 1.89 (48) | 1.89 (48) | 0.22 (5.5) |
| V5, V6 | 3.54 (90) | 4.92 (125) | 3.54 (90) | 2.68 (68) | 2.68 (68) | 0.22 (5.5) |

Manual Motor Control Switch Mounted on Enclosure Door

V0+, V0 to V4

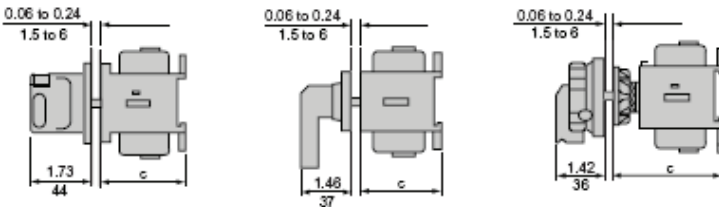

Single-hole mounting

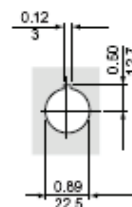

Four-hole mounting

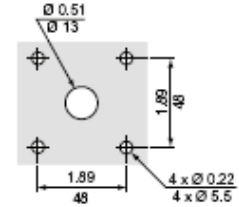

V5 and V6

Four-hole mounting

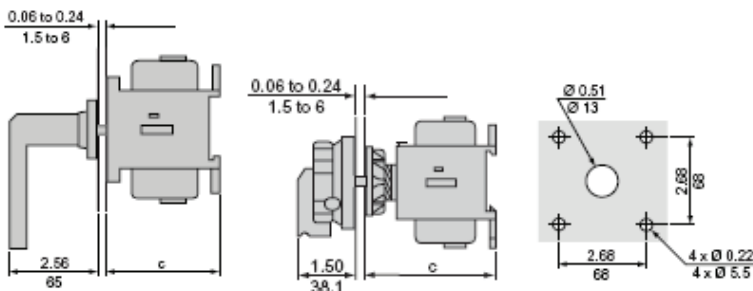

| | 4-Hole in. (mm) | Single Hole in. (mm) |
|---------------|--------------------|-------------------------|
| | c | c |
| V0+, V0 to V2 | 2.36 (60) | 3.07 (78) |
| V3, V4 | 2.56 (65) | 3.27 (83) |
| V5, V6 | 3.54 (90) | 4.25 (108) |

Dimensions: $\frac{\text{in.}}{\text{mm}}$

Manual Motor Control Switches and Disconnects

Mini-Vario and Vario Manual Motor Control Switches

Manual Motor Control Switch Mounted at back of Enclosure V0*, V0 to V2 with Shaft Extension VZ17 or VZ30 (Clip-on mounting on DIN rail possible for V0* to V2)

V0*, V0 to V2

V3 to V4 with shaft extension VZ18 or VZ31

V5 and V6 with shaft extension VZ18 or VZ31

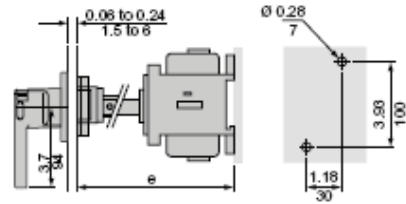
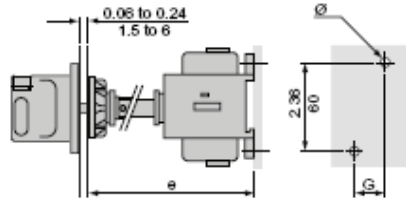
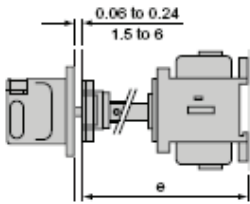

| | Shaft Extension | Distance (e) Enclosure Back/Door in. (mm) | Ø in. (mm) | G in. (mm) |
|-------------------------|-----------------|---|----------------|------------|
| V02 and V01 V0 to V2 | VZ17 | 11.81 to 12.99 (300 to 330) | 2 x 0.17 (4.2) | 0.59 (15) |
| | VZ30 | 15.75 to 16.93 (400 to 430) | 2 x 0.17 (4.2) | 0.59 (15) |
| V3 and V4 | VZ18 | 11.81 to 12.99 (300 to 330) | 2 x 0.20 (5) | 0.79 (20) |
| | VZ31 | 15.75 to 16.93 (400 to 430) | 2 x 0.20 (5) | 0.79 (20) |

| | Shaft Extension | Distance (e) Enclosure Back/Door in. (mm) |
|-----------|-----------------|---|
| V5 and V6 | VZ18 | 11.81 to 12.99 (300 to 330) |
| | VZ31 | 15.75 to 16.93 (400 to 430) |

Manual Motor Control Switches for Modular Distribution Boards

VV-0 to VV-2

VV-3 and VV-4

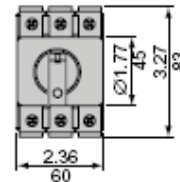
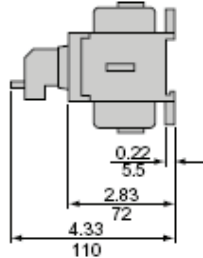
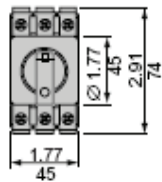
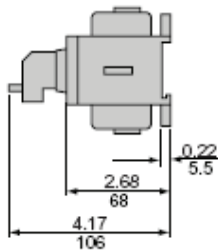

Enclosures

V-F02GE to V-F4GE, V-FXGE1 to V-FXGE4

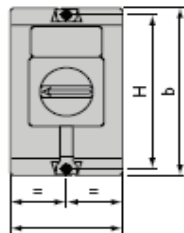
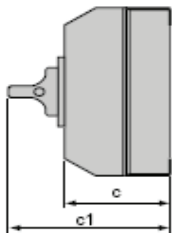

| | a | b | c | c1 | H |
|----------------------------|------------|------------|------------|------------|------------|
| V-F02GE to V-F2GE, V-FXGE1 | 3.54 (90) | 5.75 (146) | 3.35 (85) | 5.16 (131) | 5.12 (130) |
| V-F3GE and V-F4GE | 5.91 (150) | 6.69 (170) | 4.17 (106) | 5.98 (152) | 6.46 (164) |

Dimensions: $\frac{\text{in.}}{\text{mm}}$

Manual Motor Control Switches and Disconnects

Mini-Vario and Vario Manual Motor Control Switches

Switch Body

V02 and V01, V0 to V6

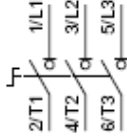

Main Pole Module

VZ02 and VZ01, VZ0 to VZ4



Neutral Pole Module

VZ11 to VZ13



Auxiliary Contact Blocks

VZ7



VZ20



Non-Metallic Enclosed Switch Dimensions

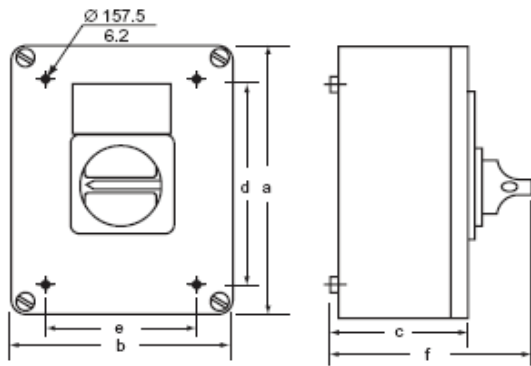

| Type | No. of Poles | a | b | c | d | e | f |
|------------------|--------------|------------|-----------|-----------|--------------|-------------|-------------|
| VC1GUN VC2GUN | 3 | 6.5 (164) | 4.8 (121) | 3.4 (87) | 5.6 (141) | 3.9 (98) | 5.2 (132) |
| VC3GUN VC4GUN | 3 | 7.6 (193) | 6.5 (164) | 3.4 (87) | 6.7 (170) | 5.6 (141) | 5.2 (132) |
| VC5GUN VC6GUN | 3 | 11.5 (291) | 9.5 (241) | 5.0 (128) | 10.6 (268.5) | 8.6 (218.5) | 7.5 (190.5) |

Dimensions: $\frac{\text{in.}}{\text{mm}}$

Metallic Enclosed Switch Dimensions

NEMA/UL Type 4, 4x, and 12: V1W30, V2W30, V1A30, and V2A30

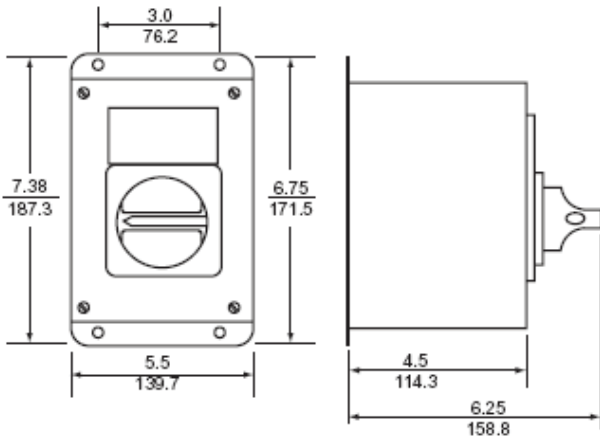

NEMA/UL Type 1: V1G30 and V2G30

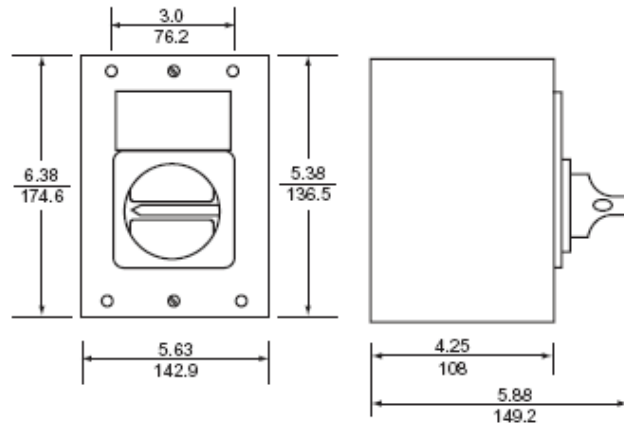

Dimensions: $\frac{\text{in.}}{\text{mm}}$

Manual Motor Control Switches and Disconnects
GS1 and GS2 Fusible and LK4 Nonfusible Disconnect Switches

GS1 and GS2 Fusible and LK4 Nonfusible Disconnect Switches

Table 24: Fusible GS1 30 A and GS2 60–800 A Disconnect Switches

| Definition and Function | Specifications | Conformity to Standards |
|--|---|--|
| <p>The GS1 and GS2 multipolar manually operated fusible disconnect switches are based on the most up-to-date disconnect switch technology.</p> <p>Suitable as service entrance equipment only when installed with a properly rated enclosure.</p> | <ul style="list-style-type: none"> • Seven ratings from 30–800 A, using Class CC, J, and L fuses. • ON and OFF switch operation • Through the door operator • Flange-mounted, cable-operated 60–200 A • NFPA 79 handle kits 30–400 A | <ul style="list-style-type: none"> • WHTY.E195721 (UL Listing) • WHTY.E195722 (UL Listing) • WHTY2.E195722 (UL Component Recognition) • CSA – Class: 4652-02 File: 703149 • CSA – Class: 4652-04 File: 703149 • IEC 60947-3 • CE |
| Product Features | | |
| <p>Practical Safeguard</p> <p>Double Break</p> <p>This modern designed mechanism disconnects on both sides of the fuse using two double breaking contacts per pole. This provides complete isolation of the fuses in the OFF position.</p> <p>Touch Safe</p> <p>Our design reduces the danger of accidental contact with live, energized parts. All products are supplied standard with fuse cover.</p> |  | <p>Exceptional 200 KA Short Circuit Protection</p> <p>The GS2 Series with the use of Class CC or J fuses provides exceptional high short circuit protection, up to 200 kA.</p> <p>Panel Space Savings</p> <p>This proven switch technology has the fuses incorporated on the top of the switch mechanism to reduce the foot print of the product and saves 50% of panel space compared to other switch designs using other fuse classes.</p> |

Table 25: Nonfusible LK4 30–1200 A Disconnect Switches

| Definition and Function | Specifications | Conformity to Standards |
|---|--|---|
| <p>The LK4*** is a multipolar manually operated switch. It is based on the most up-to-date disconnect switch technology available.</p> <p>Suitable as service entrance equipment only when installed with a properly rated enclosure.</p> | <ul style="list-style-type: none"> • Ten ratings from 30–1200 A <ul style="list-style-type: none"> – LK4 compact three ratings 30–100 A – LK4 standard 60–1200 A • ON and OFF switch operation <ul style="list-style-type: none"> – LK4 compact <ul style="list-style-type: none"> – Through the door operator – Side access operator – LK4 standard <ul style="list-style-type: none"> – Through the door operator | <ul style="list-style-type: none"> • UL98 File E19572 • CCN WHTY/WHTY2 • CSA 22.2 No. 4 File LR 703150 • Class 4651-02 • IEC 60947-3 • CE |
| Product Features | | |
| <p>Welded Contact Protection</p> <p>In case of welded contacts due to an overload or short circuit, the switch will not reach the OFF position unless the contacts are actually open.</p> | | <p>Clear Position Indication</p> <p>All switches and handles have clear ON and OFF designation.</p> |

Manual Motor Control Switches and Disconnects GS1 and GS2 Fusible and LK4 Nonfusible Disconnect Switches

Common Features for GS1, GS2, and LK4 Disconnect Switches

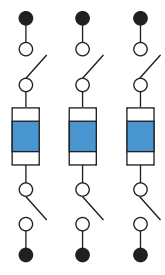
A Complete Range of Handles



The GS1, GS2, and LK4 disconnect switch series offers a full line of NEMA/UL/IP rated handles.

- Rated Type 1, 3R, 4, 4X, and 12
- IP54 and IP65

Handles offer the user the largest selection of options in operating the switch.

- Standard configuration: ON/OFF (two positions)
- All external handles are available in two colors, black or red/yellow.



Padlocking

Handles can be padlocked in the OFF position with up to three padlocks. Meets OSHA requirements for lockout/tagout procedures. For safety reasons, the door can not be opened when the handle is padlocked.

Door Interlock in ON Position

The handles allow opening of the door in OFF position only. In the ON position the door can not be opened. This interlocking can however be bypassed by authorized personnel.

Defeater

The defeat function allows qualified personnel to by-pass the door interlock when the switch is in the ON position by means of a tool. This exclusive design is also available in Type 4 and 4X ratings. The defeater cannot be actuated if the handle is padlocked.

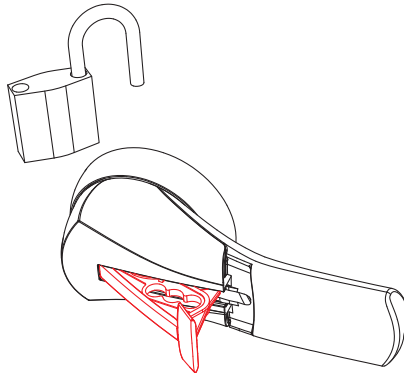

Padlocking

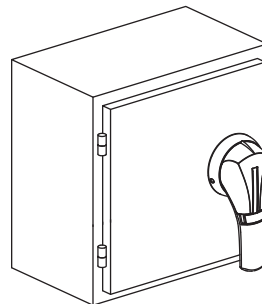

Door Interlock in ON Position

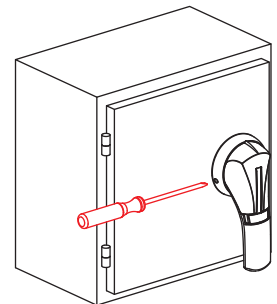

Defeater

Manual Motor Control Switches and Disconnects

GS1 and GS2 Fusible and LK4 Nonfusible Disconnect Switches

Table 26: GS1 and GS2 Fusible Disconnect Switches

UL and CSA

| Catalog Number | GS1DDU3 (compact) | GS1DU3 (compact) | GS2EEU3 | GS2EU3N | GS2GU3N | GS2JU3N | GS2MU3N | GS2QU3N | GS2SU3 | GS2TU3 |
|--|----------------------|---------------------|------------|------------|------------|-------------|---------------------|------------------------|---------------|---------------|
| Rating (A) | 30 | 30 | 30 | 30 | 60 | 100 | 200 | 400 | 600 | 800 |
| Operating Voltage (V) | 600 | 600 | 600 | 600 | 600 | 600 | 600 | 600 | 600 | 600 |
| Max hp/Max Motor FLA Current Three Phase (hp/A) | | | | | | | | | | |
| 240 V | 7.5/22 | 7.5/22 | 7.5/22 | 7.5/22 | 15/42 | 30/80 | 60/154 | 125/312 | 200 | 200 |
| 480 V | 15/21 | 15/21 | 15/21 | 15/21 | 30/40 | 60/77 | 125/156 | 250/302 | 400 | 500 |
| 600 V | 20/22 | 20/22 | 20/22 | 20/22 | 50/52 | 75/77 | 150/144 | 350/336 | 500 | 500 |
| 125 Vdc | 3/25 | 3/25 | 3/25 | 3/25 | 5/40 | — | — | — | — | — |
| 250 Vdc | 5/20 | 5/20 | 5/20 | 5/20 | 10/38 | 20/72 | 40/140 ¹ | 50/173 ¹ | — | — |
| Short Circuit Rating w/Fuses (kA) | 100 | 100 | 100 | 100 | 100 | 200 | 200 | 200 | 200 | 200 |
| Fuse Class | CC | J | CC | J | J | J | J | J | J | L |
| Fuse Rating (A) | 30 | 30 | 30 | 30 | 60 | 100 | 200 | 400 | 600 | 800 |
| Endurance (no. of operations) | | | | | | | | | | |
| Electrical Endurance | 6000 | 6000 | 6000 | 6000 | 6000 | 6000 | 6000 | 1000 | 1000 | 1000 |
| Mechanical Endurance | 10000 | 10000 | 10000 | 10000 | 10000 | 10000 | 8000 | 6000 | 5000 | 5000 |
| Dimensions 3 Pole | | | | | | | | | | |
| H in. (mm) | 4.56 (116) | 4.56 (116) | 5.31 (135) | 5.35 (136) | 5.35 (136) | 11.46 (291) | 7.67 (195) | 15.34 (390) | 11.18 (284) | 11.18 (284) |
| W in. (mm) | 3.8 (97) | 4.15 (105) | 4.92 (125) | 5.87 (149) | 5.87 (149) | 5.87 (149) | 7.72 (196) | 10.19 (259) | 11.81 (300) | 11.81 (300) |
| D in. (mm) | 3.3 (84) | 3.9 (99) | 3.9 (99) | 4.84 (123) | 4.84 (123) | 4.81 (122) | 5.11 (130) | 7.08 (180) | 9.84 (250) | 9.84 (250) |
| Shaft Size Square, in. | 0.2 x 0.2 | 0.2 x 0.2 | 0.4 x 0.4 | 0.4 x 0.4 | 0.4 x 0.4 | 0.4 x 0.4 | 0.4 x 0.4 | 0.4 x 0.4 | 0.59 x 0.59 | 0.59 x 0.59 |
| Shaft Size Square, mm. | 5 x 5 | 5 x 5 | 10 x 10 | 10 x 10 | 10 x 10 | 10 x 10 | 10 x 10 | 10 x 10 | 15 x 15 | 15 x 15 |
| Switch Operating Torque, lb. in. | 21 | 21 | 53 | 88 | 88 | 88 | 106 | 132 | 350 | 350 |
| Terminal Lug Kits | Integrated | Integrated | Standard | Standard | Integrated | Integrated | GS1AW403 | GS1AW603 350 MCM-#6 | GS1AW503 | GS1AW503 |
| Wire Range AWG | | | | | | | | | | |
| min (mm ²) | #14 (2) | #14 (2) | #14 (2) | #14 (2) | #10 (6) | #12 (34) | #6 (16) | GS1AW606 600 MCM-#4 | 2 x 2 (34) | 2 x 2 (34) |
| max (mm ²) | #10 (6) | #10 (6) | #10 (6) | #6 (13) | #6 (16) | #1 (42) | #300 (152) | or 250 MCM-#10 | 2 x 600 (304) | 2 x 600 (304) |
| Wire Tightening, lb. in. (N•m) | 27 (3) | 27 (3) | 48 (5.4) | 58 (6.6) | 31 (3.5) | 35.4 (4) | 275 (8.5) | 160 (18.1) | 500 (56.5) | 500 (56.5) |
| Lug Mounting, lb. in. (N•m) | Integrated | Integrated | Integrated | Integrated | Integrated | Integrated | Integrated | Integrated | 310 (35.0) | 310 (35.0) |
| Auxiliary Contacts | | | | | | | | | | |
| NEMA/UL Rating, AC | A600 | A600 | A600 | A600 | A600 | A600 | A600 | A600 | A600 | A600 |
| NEMA/UL Rating, DC | N600 | N600 | N600 | N600 | N600 | N600 | N600 | N600 | N600 | N600 |

IEC

| Catalog Number | GS1DDU3 | GS1DU3 | GS2EEU3 | GS2EU3N | GS2GU3N | GS2JU3N | GS2MU3N | GS2QU3N | GS2SU3 | GS2TU3 |
|--|---------|--------|---------|---------|---------|---------|---------|---------|--------|------------|
| Rating (A) | 32 | 32 | 32 | 32 | 63 | 100 | 200 | 400 | 630 | 800 |
| Rated Insulation Voltage Ui (V) | 690 | 690 | 750 | 750 | 750 | 750 | 750 | 800 | 1000 | 1000 |
| Rated Impulse Voltage (Uimp) | 8 kV | 8 kV | 8 kV | 8 kV | 8 kV | 8 kV | 8 kV | 8 kV | 12 kV | 12 kV |
| Operation Current Ie | | | | | | | | | | |
| 400 V AC | A | | | | | | | | | |
| AC 22A | 32 | 32 | 32 | 32 | 63 | 100 | 200 | 400 | 630 | 800 |
| AC 23A | 32 | 32 | 32 | 32 | 63 | 100 | 200 | 400 | 630 | 800 |
| 690 V AC | | | | | | | | | | |
| AC 22A | 32 | 32 | 32 | 32 | 63 | 100 | 200 | 400 | 630 | 800 |
| AC 23A | 32 | 32 | 32 | 32 | 63 | 100 | 200 | 250 | 630 | 630 |
| Motor Power (kW) | | | | | | | | | | |
| 400 Vac | AC 23A | 15 | 15 | 15 | 30 | 51 | 100 | 220 | 355 | 450 |
| 500 Vac | AC 23A | 18.5 | 18.5 | 18.5 | 40 | 63 | 140 | 220 | 450 | 560 |
| 690 Vac | AC 23A | 25 | 25 | 25 | 55 | 90 | 185 | 220 | 600 | 600 |
| Maximum Peak let through Current, kA peak | 5.5 | 5.5 | 7.6 | 17.6 | 17.6 | 22 | 32 | 36 | 77 | 77 |
| Connection | | | | | | | | | | |
| Min. Cu Cable Section (mm ²) | 2 | 2 | 2 | 2 | 6 | 34 | 16 | 2 x 16 | 2 x 34 | 2 x 40 x 5 |
| Min. Cu Busbar Section (mm ²) | — | — | — | — | — | — | — | — | — | — |

¹ 3 poles in series in one of the following conditions: 3 poles on +, 2 poles on + and 1 on -, 1 pole on + and 2 on -, 3 poles on -.

Ambient air temperature

Operating temperature: -20 to +70 °C

Storage temperature: -40 to +80 °C

Manual Motor Control Switches and Disconnects

GS1 and GS2 Fusible and LK4 Nonfusible Disconnect Switches

Table 27: LK4 Nonfusible Disconnect Switches

UL and CSA

| Catalog Number | LK4DU3CN | LK4GU3CN | LK4JU3CN | LK4JU3N | LK4MU3N | LK4QU3N | LK4SU3N | LK4TU3N | LK4UU3N | LK4WU3N |
|--|------------------------|------------------------|------------------------|--------------------------------|--------------------------------|---|--------------------------------------|--------------------------------------|--------------------------------------|--------------------------------------|
| Rating (A) | 30 | 60 | 100 | 100 | 200 | 400 | 600 | 800 | 1000 | 1200 |
| Operating Voltage (V) | 600 | 600 | 600 | 600 | 600 | 600 | 600 | 600 | 600 | 600 |
| Max hp/Max Motor FLA Current Three Phase (hp/A) | | | | | | | | | | |
| 240 V | 10/30 | 20/56 | 20/53 | 30/80 | 75/92 | 125/312 | 200/480 | 200/480 | 200/480 | 200/480 |
| 480 V | 20/28 | 40/53 | 50/64 | 75/96 | 150/187 | 250/302 | 400/477 | 500/590 | 500/590 | 500/590 |
| 600 V | 25/28 | 50/52 | 50/51 | 100/100 | 200/192 | 350/336 | 350/336 | 500/472 | 500/472 | 500/472 |
| 125 Vdc | — | — | — | 10/77 | 15/112 ¹ | 20/148 ¹ | 20/148 ¹ | — | — | — |
| 250 Vdc | — | — | — | 15/54 | 15/56 ² | 50/173 ² | 50/173 ² | — | — | — |
| Short Circuit Rating w/Fuses (kA) | 100 | 100 | 100 | 200 | 200 | 200 | 200 | 100 | 100 | 100 |
| Fuse Class | J | J | J | J | J | J | J | L | L | L |
| Fuse Rating (A) | 30 | 60 | 100 | 100 | 200 | 400 | 600 | 800 | 1000 | 1200 |
| Endurance (no. of operations) | | | | | | | | | | |
| Electrical Endurance | 6000 | 6000 | 6000 | 6000 | 6000 | 1000 | 1000 | 500 | 500 | 500 |
| Mechanical Endurance | 10000 | 10000 | 10000 | 8000 | 8000 | 6000 | 6000 | 3500 | 3500 | 3500 |
| Dimensions 3 Pole | | | | | | | | | | |
| H in. (mm) | 4.92 (125) | 4.92 (125) | 4.92 (125) | 6.30 (160) | 6.30 (160) | 10.23 (260) | 12.6 (320) | 13 (320) | 13 (320) | 13 (320) |
| W in. (mm) | 3.13 (79.5) | 3.13 (79.5) | 3.13 (79.5) | 7.08 (180) | 7.08 (180) | 9.05 (230) | 11 (279) | 14.65 (370) | 14.65 (370) | 14.65 (370) |
| D in. (mm) | 2.52 (64) | 2.52 (64) | 2.52 (64) | 3.74 (95) | 3.74 (95) | 4.92 (128) | 5.51 (140) | 5.51 (140) | 5.51 (140) | 5.51 (140) |
| Shaft Size Square, in. | 0.2 x 0.2 | 0.2 x 0.2 | 0.2 x 0.2 | 0.4 x 0.4 | 0.4 x 0.4 | 0.4 x 0.4 | 0.59 x 0.59 | 0.59 x 0.59 | 0.59 x 0.59 | 0.59 x 0.59 |
| Shaft Size Square, mm. | 5 x 5 | 5 x 5 | 5 x 5 | 10 x 10 | 10 x 10 | 10 x 10 | 15 x 15 | 15 x 15 | 15 x 15 | 15 x 15 |
| Switch Operating Torque, lb. in. | 21 | 88 | 88 | 106 | 106 | 320 | 320 | 1320 | 320 | 320 |
| Terminal Lug Kits | Standard | Standard | Standard | GS1AW403 | GS1AW403 | GS1AW603 350 MCM-#6 | GS1AW503 | GS1AW903 | GS1AW903 | GS1AW903 |
| Wire Range AWG min (mm ²) max (mm ²) | #12 (4) #2/0 (50) | #12 (4) #2/0 (50) | #12 (4) #2/0 (50) | #6 (16) #300 (152) kcmil | #6 (16) #300 (152) kcmil | GS1AW606 600 MCM-#4 or 250 MCM-#10 | 2 x 2 (34) 2 x 600 (304) kcmil | 2 x 2 (34) 2 x 600 (304) kcmil | 2 x 2 (34) 2 x 600 (304) kcmil | 2 x 2 (34) 2 x 600 (304) kcmil |
| Wire Tightening, lb. in. (N·m) Lug Mounting, lb. in. (N·m) | 35.4 (4) Integrated | 35.4 (4) Integrated | 35.4 (4) Integrated | 160 (18.1) 200 (22.6) | 160 (18.1) 200 (22.6) | | 500 (56.5) 310 (35) | 500 (56.5) 310 (35) | 500 (56.5) 310 (35) | 500 (56.5) 310 (35) |
| Auxiliary Contacts NEMA/UL Rating, AC NEMA/UL Rating, DC | A600 N600 | A600 N600 | A600 N600 | A600 N600 | A600 N600 | A600 N600 | A600 N600 | A600 N600 | A600 N600 | A600 N600 |

IEC

| Catalog Number | LK4DU3CN | LK4GU3CN | LK4JU3CN | LK4JU3N | LK4MU3N | LK4QU3N | LK4SU3N | LK4TU3N | LK4UU3N | LK4WU3N |
|--|-----------------------|----------|------------|------------|------------|------------|------------|------------|--------------|--------------|
| Rating (A) | 32 | 63 | 100 | 100 | 200 | 400 | 600 | 800 | 1000 | 1200 |
| Rated Insulation Voltage Ui (V) | 690 | 750 | 750 | 750 | 750 | 1000 | 1000 | 1000 | 1000 | 1000 |
| Rated Impulse Voltage (Uimp) | 8 kV | 8 kV | 8 kV | 8 kV | 8 kV | 12 kV | 12 kV | 12 kV | 12 kV | 12 kV |
| Operation Current Ie | | | | | | | | | | |
| 400 Vac | A AC 22A AC 23A | 32 63 | 100 100 | 100 100 | 200 200 | 400 400 | 630 630 | 800 800 | 1000 1000 | 1200 1000 |
| 690 Vac | AC 22A AC 23A | 32 63 | 100 100 | 100 100 | 200 200 | 400 200 | 500 200 | 630 400 | 630 400 | 630 400 |
| Motor Power (kW) | | | | | | | | | | |
| 400 V AC | AC 23A | 15 | 30 | 51 | 51 | 100 | 220 | 355 | 450 | 560 |
| 500 V AC | AC 23A | 18.5 | 40 | 63 | 63 | 140 | 280 | 450 | 560 | 560 |
| 690 V AC | AC 23A | 25 | 55 | 90 | 90 | 185 | 185 | 185 | 400 | 400 |
| Maximum Peak let through Current, kA peak | 5.5 | 17.6 | 17.6 | 17.6 | 32 | 48 | 48 | 75 | 75 | 75 |
| Connection | | | | | | | | | | |
| Min. Cu Cable Section (mm ²) | 4 | 4 | 4 | 4 | 16 | 16 | 2 x 34 | 2 x 34 | 2 x 34 | — |
| Min. Cu Busbar Section (mm ²) | — | — | — | — | — | — | 2 x 30 x 5 | 2 x 40 x 5 | 2 x 50 x 5 | 2 x 60 x 5 |

¹ 2 poles in series.

² 3 poles in series in one of the following conditions: 3 poles on +, 2 poles on + and 1 on -, 1 pole on + and 2 on -, 3 poles on -.

Manual Motor Control Switches and Disconnects

GS1 and GS2 Fusible and LK4 Nonfusible Disconnect Switches

Fusible Disconnect Switches

Select one of each:

1 Switch
(see below)

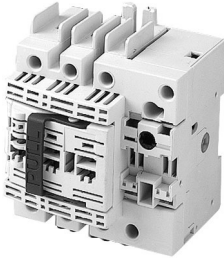

Compact 30 A Switch
GS1DDU3

1 Shaft
(see page 32)



Shaft 320 mm
GS2AE2

1 Handle
(see page 32)



Black Handle
GS2AH110

1 Lug Kit (if required)
(see page 34)



Lug Kit
GS1AW403



100 A Switch
GS2JU3N

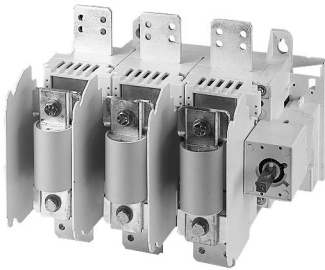

800 A Switch
GS2TU3

Table 28: Compact GS1 30 A

| Type | Fuses | Amps | Nb | Maximum Horse Power Rating | | | Catalog Number | Shaft Style ¹ |
|---------|-------|------|-------|----------------------------|-------|-------|----------------|--------------------------|
| | | | | Three Phase | | | | |
| Compact | | | Poles | 240 V | 480 V | 600 V | | |
| Fused | CC | 30 | 3 | 7.5 | 15 | 20 | GS1DDU3 | AG |
| Fused | J | 30 | 3 | 7.5 | 15 | 20 | GS1DU3 | AG |

Table 29: GS2 30–400 A

| Type | Fuses | Amps | Nb | Maximum Horse Power Rating | | | Catalog Number | Shaft Style ¹ |
|---------|-------|------|-------|----------------------------|-------|-------|----------------------|--------------------------|
| | | | | Three Phase | | | | |
| Compact | | | Poles | 240 V | 480 V | 600 V | | |
| Fused | CC | 30 | 3 | 7.5 | 15 | 20 | GS2EEU3 | B |
| Fused | J | 30 | 3 | 7.5 | 15 | 20 | GS2EU3N | B |
| Fused | J | 60 | 3 | 15 | 30 | 50 | GS2GU3N | B |
| Fused | J | 100 | 3 | 30 | 60 | 75 | GS2JU3N | B |
| Fused | J | 200 | 3 | 60 | 125 | 150 | GS2MU3N ² | B |
| Fused | J | 400 | 3 | 125 | 250 | 350 | GS2QU3N ² | B |

Table 30: GS2 600–800 A

| Type | Fuses | Amps | Nb | Maximum Horse Power Rating | | | Catalog Number | Shaft Style ¹ |
|---------|-------|------|-------|----------------------------|-------|-------|---------------------|--------------------------|
| | | | | Three Phase | | | | |
| Compact | | | Poles | 240 V | 480 V | 600 V | | |
| Fused | J | 600 | 3 | 200 | 400 | 500 | GS2SU3 ² | C |
| Fused | L | 800 | 3 | 200 | 500 | 500 | GS2TU3 ² | C |

¹ Match the switch with the shaft. For example, match the "AG" designation on the switch with the "AG" designation on the shaft.

² Terminal lugs must be ordered separately.

Table 31: Cable Operator Kits for GS2 Switches

| Catalog Number | Description |
|----------------|----------------------------|
| GS2AH36F | 36 in. Cable Operator Kit |
| GS2AH60F | 60 in. Cable Operator Kit |
| GS2AH120F | 120 in. Cable Operator Kit |
| GS2AH144F | 144 in. Cable Operator Kit |
| GS2AH180F | 180 in. Cable Operator Kit |

Manual Motor Control Switches and Disconnects

GS1 and GS2 Fusible and LK4 Nonfusible Disconnect Switches

Nonfusible Disconnect Switches

Select one of each:

1 Switch
(see below)

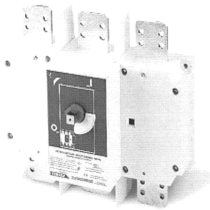

100–400 A Switch

1 Shaft
(see page 32)



Shaft 32 mm
GS2AE6

1 Handle
(see page 32)



Black Handle
GS2AH150

1 Lug Kit (if required)
(see page 34)



GS1AW503

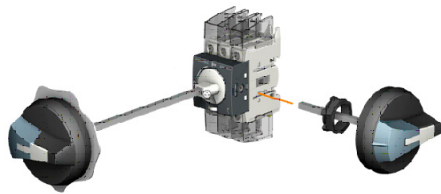

30 A Compact
LK4DU3CN

Table 32: Compact LK4 30–100 A

| Type | Amps | Nb | Maximum Horse Power Rating | | | Catalog Number | Shaft Style ¹ |
|----------|------|-------|----------------------------|-------|-------|----------------|--------------------------|
| | | | Three Phase | | | | |
| Compact | | Poles | 240 V | 480 V | 600 V | | |
| Nonfused | 30 | 3 | 10 | 20 | 28 | LK4DU3CN | AL |
| Nonfused | 60 | 3 | 20 | 40 | 50 | LK4GU3CN | AL |
| Nonfused | 100 | 3 | 20 | 50 | 50 | LK4JU3CN | AL |

Table 33: LK4 100–200 A

| Type | Amps | Nb | Maximum Horse Power Rating | | | Catalog Number | Shaft Style ¹ |
|----------|------|-------|----------------------------|-------|-------|----------------------|--------------------------|
| | | | Three Phase | | | | |
| | | Poles | 240 V | 480 V | 600 V | | |
| Nonfused | 100 | 3 | 30 | 75 | 100 | LK4JU3N ² | B |
| Nonfused | 200 | 3 | 75 | 150 | 200 | LK4MU3N ² | B |

Table 34: LK4 400–1200 A

| Type | Amps | Nb | Maximum Horse Power Rating | | | Catalog Number | Shaft Style ¹ |
|----------|------|-------|----------------------------|-------|-------|----------------------|--------------------------|
| | | | Three Phase | | | | |
| | | Poles | 240 V | 480 V | 600 V | | |
| Nonfused | 400 | 3 | 125 | 250 | 350 | LK4QU3N ² | B |
| Nonfused | 600 | 3 | 200 | 400 | 350 | LK4SU3N ² | D |
| Nonfused | 800 | 3 | 250 | 500 | 500 | LK4TU3N ² | D |
| Nonfused | 1000 | 3 | 200 | 500 | 500 | LK4UU3N ² | D |
| Nonfused | 1200 | 3 | 200 | 500 | 500 | LK4WU3N ² | D |

¹ Match the switch with the shaft. For example, match the "AL" designation on the switch with the "AL" designation on the shaft.

² Terminal lugs must be ordered separately.

Manual Motor Control Switches and Disconnects

GS1 and GS2 Fusible and LK4 Nonfusible Disconnect Switches

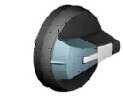

LK4AH110CN
Handle Style L1



GS2AH110
Handle Style H1



GS2AH130
Handle Style H2



GS2AH150
Handle Style H3



GS2AH170
Handle Style H4

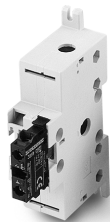

Auxiliary Contacts
GS1AD10 + GS2AM110

Table 35: Handles and Shafts for GS Switches

| Rating (A) | Handle | | | | Shaft: 12.6 in. (320 mm) Catalog No. | Shaft: 15.7 in. (400 mm) Catalog No. | Shaft Style ¹ |
|---------------|-------------|-------|-----------|------------|--|---|-----------------------------|
| | Catalog No. | Style | Type | Color | | | |
| 30–60 | GS2AH110 | H1 | 1, 3R, 12 | Black | GS2AE8 (GS1DDU3 or DU3 only) GS2AE2 | GS2AE81 (GS1DDU3 or DU3 only) GS2AE21 | AG |
| 30–60 | GS2AH120 | H1 | 1, 3R, 12 | Red/Yellow | | | |
| 30–60 | GS2AH410 | H1 | 4, 4X | Black | | | |
| 30–60 | GS2AH420 | H1 | 4, 4X | Red/Yellow | | | |
| 30–400 | GS2AH130 | H2 | 1, 3R, 12 | Black | GS2AE2 | GS2AE21 | B |
| 30–400 | GS2AH140 | H2 | 1, 3R, 12 | Red/Yellow | | | |
| 30–400 | GS2AH430 | H2 | 4, 4X | Black | | | |
| 30–400 | GS2AH440 | H2 | 4, 4X | Red/Yellow | | | |
| 600–800 | GS2AH150 | H3 | 4, 4X | Black | GS2AE5 | GS2AE51 | C |
| 600–800 | GS2AH160 | H3 | 4, 4X | Red/Yellow | | | |

¹ Match the switch with the shaft. For example, match the “AG” designation on the switch with the “AG” designation on the shaft.

Table 36: Handles and Shafts for LK Switches

| Rating (A) | Handle | | | | Shaft: 12.6/320 in./mm Catalog No. | Shaft: 15.7/400 in./mm Catalog No. | Shaft Guide ¹ Catalog No. | Shaft Style ² |
|----------------|-------------|-------|-----------|------------|--|--|---|-----------------------------|
| | Catalog No. | Style | Type | Color | | | | |
| 30–100 Compact | LK4AH110CN | L1 | 1, 3R, 12 | Black | LK4AE12CN | — | GS2AEH12 | AL |
| 30–100 Compact | LK4AH120CN | L1 | 1, 3R, 12 | Red/Yellow | | | | |
| 30–100 Compact | LK4AH410CN | L1 | 4, 4X | Black | | | | |
| 30–100 Compact | LK4AH420CN | L1 | 4, 4X | Red/Yellow | | | | |
| 100–400 | GS2AH130 | H2 | 1, 3R, 12 | Black | GS2AE2 | GS2AE21 | GS2AEH12 | B |
| 100–400 | GS2AH140 | H2 | 1, 3R, 12 | Red/Yellow | | | | |
| 100–400 | GS2AH430 | H2 | 4, 4X | Black | | | | |
| 100–400 | GS2AH440 | H2 | 4, 4X | Red/Yellow | | | | |
| 600 | GS2AH150 | H3 | 4, 4X | Black | GS2AE6 | GS2AE61 | GS2AEH12 | D |
| 600 | GS2AH160 | H3 | 4, 4X | Red/Yellow | | | | |
| 800–1200 | GS2AH170 | H4 | 4, 4X | Black | | | | |
| 800–1200 | GS2AH180 | H4 | 4, 4X | Red/Yellow | | | | |

¹ Required on shafts for LK4DU3CN and LK4GU3CN switches.

² Match the switch with the shaft. For example, match the “AG” designation on the switch with the “AG” designation on the shaft.

The handle kits listed in Table 37 are new—released in 2015.

Table 37: *New!* Complete Kits

| Rating | Kit Catalog Number | Pieces Included ¹ | | | | |
|--------|--------------------|------------------------------|--------------|-----------------------|-------------|------------|
| | | Compact Switch | 400 mm Shaft | Handle Color / Rating | Handle | Guide Cone |
| 30 A | LK4DUKB1 | LK4DU3CN | LK4AE41CN | Black / NEMA 1,12,3R | LK4AH0110CN | GS2AEH12 |
| 30 A | LK4DUKB4 | LK4DU3CN | LK4AE41CN | Black / NEMA 4, 4X | LK4AH0410CN | GS2AEH12 |
| 30 A | LK4DUKR1 | LK4DU3CN | LK4AE41CN | Red / NEMA 1,12,3R | LK4AH0120CN | GS2AEH12 |
| 30 A | LK4DUKR4 | LK4DU3CN | LK4AE41CN | Red / NEMA 4, 4X | LK4AH0420CN | GS2AEH12 |
| 60 A | LK4GUKB1 | LK4GU3CN | LK4AE41CN | Black / NEMA 1,12,3R | LK4AH0110CN | GS2AEH12 |
| 60 A | LK4GUKB4 | LK4GU3CN | LK4AE41CN | Black / NEMA 4, 4X | LK4AH0410CN | GS2AEH12 |
| 60 A | LK4GUKR1 | LK4GU3CN | LK4AE41CN | Red / NEMA 1,12,3R | LK4AH0120CN | GS2AEH12 |
| 60 A | LK4GUKR4 | LK4GU3CN | LK4AE41CN | Red / NEMA 4, 4X | LK4AH0420CN | GS2AEH12 |
| 100 A | LK4JUKB1 | LK4JU3CN | LK4AE41CN | Black / NEMA 1,12,3R | LK4AH0110CN | GS2AEH12 |
| 100 A | LK4JUKB4 | LK4JU3CN | LK4AE41CN | Black / NEMA 4, 4X | LK4AH0410CN | GS2AEH12 |
| 100 A | LK4JUKR1 | LK4JU3CN | LK4AE41CN | Red / NEMA 1,12,3R | LK4AH0120CN | GS2AEH12 |
| 100 A | LK4JUKR4 | LK4JU3CN | LK4AE41CN | Red / NEMA 4, 4X | LK4AH0420CN | GS2AEH12 |

¹ Components are NOT sold separately. Only 400 mm shaft can be purchased separately.

Manual Motor Control Switches and Disconnects

GS1 and GS2 Fusible and LK4 Nonfusible Disconnect Switches

Table 38: Auxiliary Contacts for GS Switches ¹

| Switch Amperes | Catalog Number | Description |
|----------------|-----------------|--------------------------|
| 30–800 | GS2AM110 | Auxiliary contact 1 N.O. |
| 30–800 | GS2AM101 | Auxiliary contact 1 N.C. |
| 30 Compact | GS1AD10 | Auxiliary contact holder |

¹ GS1DU3 and GS1DDU3 switches allow up to four auxiliary contacts without adding contact holder GS1AD10. For more than four contacts, GS1AD10 is required.

Table 39: Terminal Shrouds for GS Switches, Line or Load ¹

| Switch Amperes | Catalog Number | Description |
|----------------|----------------|------------------------|
| 30–100 | GS1AP33 | Standard on product |
| 200 | GS2AP43 | GS2, 3-pole, 200 A |
| 400 | GS2AP53 | GS2, 3-pole, 400 A |
| 600–800 | GS2AP73 | GS2, 3-pole, 600–800 A |

¹ Order one terminal shroud per side. For example, order one terminal shroud for *either* the line side *or* the load side; order two terminal shrouds for *both* the line side *and* the load side.

Table 40: Shorting Links

| For use on | Shorting Links per Kit | Catalog No. |
|----------------|------------------------|-----------------|
| GS2, 60 A | 3 | GS1AU203 |
| GS2, 100 A | 3 | GS1AU303 |
| GS2, 200 A | 3 | GS1AU403 |
| GS2, 400 A | 3 | GS1AU503 |
| GS2, 600–800 A | 3 | GS1AU803 |

Manual Motor Control Switches and Disconnects

GS1 and GS2 Fusible and LK4 Nonfusible Disconnect Switches

Accessories

Table 41: Auxiliary Contacts for LK Switches

| Switch Amperes | Catalog Number | Description |
|----------------|----------------|-------------------------------|
| 30–100 Compact | MDSAN11 | Aux Contact 1 N.O. and 1 N.C. |
| 30–100 Compact | MDSAN20 | Aux Contact 2 N.O. and 2 N.C. |
| 100–400 | LK4AD10N | Aux Contact 1 N.O. and 1 N.C. |
| 100–400 | LK4AD20N | Aux Contact 2 N.O. and 2 N.C. |
| 600–1200 | LK4AD30N | Aux Contact Holder |
| 600–1200 | GS2AM110 | Aux Contact 1 N.O. |
| 600–1200 | GS2AM101 | Aux Contact 1 N.C. |

Table 42: Terminal Shrouds for LK Switches

| Switch Amperes | Catalog Number | Description |
|-----------------------|----------------|---------------------------------------|
| 30–60 | LK4AP3CN | Shroud Top and Bottom, 3-Pole |
| 100–200 | LK4AP33TN | Shroud Top LK4, 3-Pole, 100/200 A |
| 100–200 | LK4AP33BN | Shroud Bottom LK4, 3-Pole, 100/200 A |
| 400 | LK4AP53TN | Shroud Top LK4, 3-Pole, 400 A |
| 400 | LK4AP53BN | Shroud Bottom LK4, 3-Pole, 400 A |
| 600 ¹ | LK4AP63N | Shroud Bottom LK4, 3-Pole, 600 A |
| 800–1200 ¹ | LK4AP83N | Shroud Bottom LK4, 3-Pole, 800–1200 A |

¹ 600–1200 A standard with top shroud.

Table 43: Terminal Lugs

| For Use On | Rating | No. of Wires per Lug | No. of Lugs per Terminal | Lug Size (AWG) | Wire Type | Lugs per Kit | Lug Kit Catalog No. |
|------------|--------|----------------------|--------------------------|-----------------|-----------|--------------|---------------------|
| LK4DU3CN | 30 | 1 | 1 | #12–2/0 | Cu | — | Standard |
| LK4GU3CN | 60 | 1 | 1 | #12–2/0 | Cu | — | Standard |
| LK4JU3N | 100 | 1 | 1 | 6–300 kcmil | Cu/Al | 6 | GS1AW403 |
| LK4MU3N | 200 | 1 | 1 | 6–300 kcmil | Cu/Al | 6 | GS1AW403 |
| LK4QU3N | 400 | 2 | 1 | 350 MCM–6 | Cu/Al | — | GS1AW603 |
| | | 1 | 1 | 600 MCM–4 | Cu/Al | 6 | GS1AW606 |
| | | 2 | 1 | 250 MCM–1/0 | Cu/Al | 6 | GS1AW606 |
| LK4SU3N | 600 | 2 | 1 | 2 x 2–600 kcmil | Cu/Al | 6 | GS1AW503 |
| LK4TU3N | 800 | 2 | 2 | 2 x 2–600 kcmil | Cu/Al | 12 | GS1AW903 |
| LK4UU3N | 1000 | 2 | 2 | 2 x 2–600 kcmil | Cu/Al | 12 | GS1AW903 |
| LK4WU3N | 1200 | 2 | 2 | 2 x 2–600 kcmil | Cu/Al | 12 | GS1AW903 |
| GS1DDU3 | 30 | 1 | 1 | #14–#10 | Cu | — | Standard |
| GS1DU3 | 30 | 1 | 1 | #14–#10 | Cu | — | Standard |
| GS2GU3N | 60 | 1 | 1 | #10–#6 | Cu | — | Standard |
| GS2JU3N | 100 | 1 | 1 | #12–#1 | Cu | — | Standard |
| GS2MU3N | 200 | 1 | 1 | 6–300 kcmil | Cu/Al | 6 | GS1AW403 |
| GS2QU3N | 400 | 2 | 1 | 350 MCM–6 | Cu/Al | — | GS1AW603 |
| | | 1 | 1 | 600 MCM–4 | Cu/Al | 6 | GS1AW606 |
| | | 2 | 1 | 250 MCM–1/0 | Cu/Al | 6 | GS1AW606 |
| GS2SU3 | 600 | 2 | 1 | 2 x 2–600 kcmil | Cu/Al | 6 | GS1AW503 |
| GS2TU3 | 800 | 2 | 1 | 2 x 2–600 kcmil | Cu/Al | 6 | GS1AW503 |

Table 44: Power Distribution Lugs

| For Use On | Rating | No. of Wires per Lug | Lug Size (AWG) | Wire Type | Lugs per Kit | Lug Kit Catalog Number |
|--------------------|------------|----------------------|----------------|-----------|--------------|------------------------|
| GS1JU3 | 100 | 6 | #14–#6 | Cu | 3 | GS1AW306 ¹ |
| GS2MU3N GS2QU3N | 200 400 | 12 | #14–#4 | Cu | 3 | GS1AW406 |
| GS2MU3N GS2QU3N | 200 400 | 6 | #12–2/0 | Cu | 3 | GS1AW506 |

¹ Cannot be used on GS2JU3N.



Terminal Lugs

Manual Motor Control Switches and Disconnects GS1 and GS2 Fusible and LK4 Nonfusible Disconnect Switches

LK4DU3CN / LK4GU3CN / LK4JU3CN, 30–100 A Compact Nonfusible Disconnect Switches

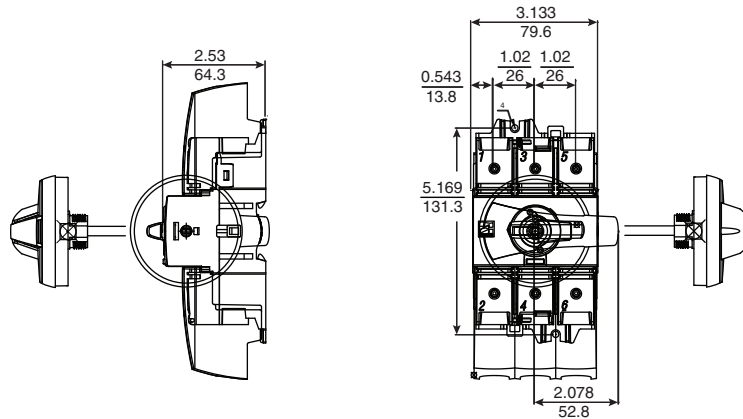

Handle for 30–100 A Compact Nonfusible Disconnect Switches

Handle part no.

- LK4AH110CN
- LK4AH120CN
- LK4AH410CN
- LK4AH420CN

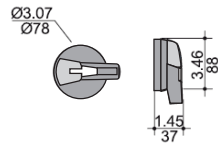

Right-side or front operation

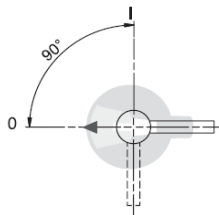

Door drilling with 4 fixing screws

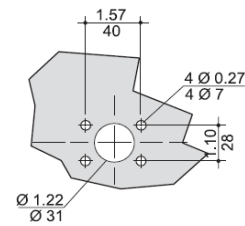

Door drilling with fixing nut

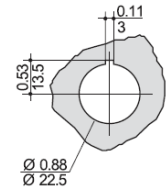

LK4JU3N / LK4MU3N / LK4QU3N, 100–400 A Nonfusible Disconnect Switches—Dimensions

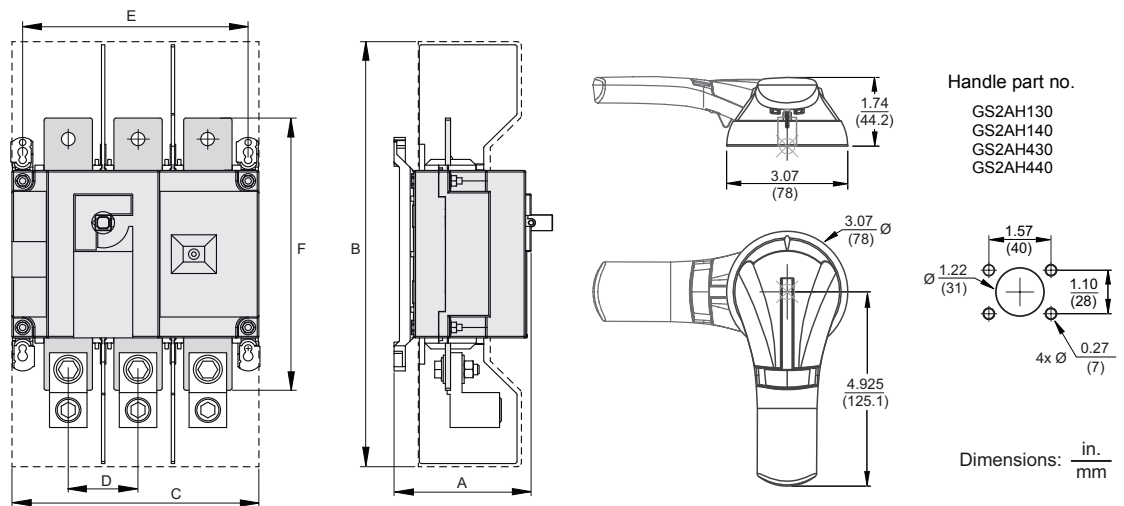

Handle part no.

- GS2AH130
- GS2AH140
- GS2AH430
- GS2AH440

Dimensions: $\frac{\text{in.}}{\text{mm}}$

| Rating (A) | Dimensions = in. (mm) | | | | | |
|------------|-----------------------|------------|-------------|-----------|------------|------------|
| | A | B | C | D | E | F |
| 100–200 | 3.72 (94.6) | 10.1 (256) | 7.09 (1.80) | 1.97 (50) | 6.3 (160) | 6.3 (160) |
| 400 | 4.92 (128) | 16 (406) | 9.05 (230) | 2.56 (65) | 8.26 (210) | 10.2 (260) |

Manual Motor Control Switches and Disconnects

GS1 and GS2 Fusible and LK4 Nonfusible Disconnect Switches

LK4SU3N, 600 A Nonfusible Disconnect Switches—Dimensions

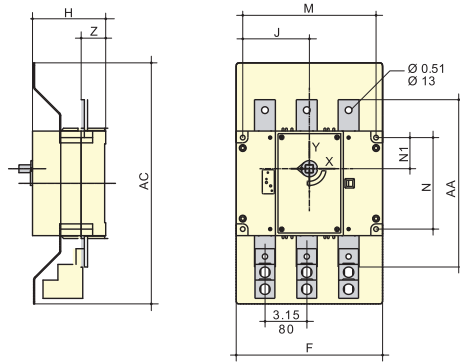

| Rating (A) | Dimensions = in. (mm) | | | | | | | | |
|------------|-----------------------|----------|-----------|-------------|-------------|------------|-------------|------------|-----------|
| | AC | F | H | J | M | N | N1 | AA | Z |
| 600 | 18.12 (460) | 11 (280) | 5.5 (140) | 5.0 (127.5) | 10.03 (255) | 6.88 (175) | 2.34 (59.5) | 12.6 (320) | 1.85 (47) |

Handle for 600 A and 800 A Fusible Disconnect Switches

Handle part no.
GS2AH150
GS2AH160

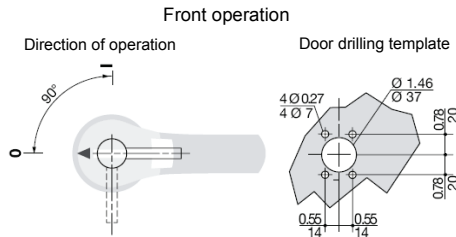
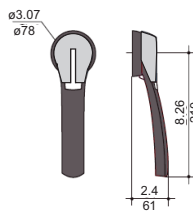

LK4TU3N / LK4UU3N / LK4WU3N, 800–1200 A Nonfusible Disconnect Switches—Dimensions

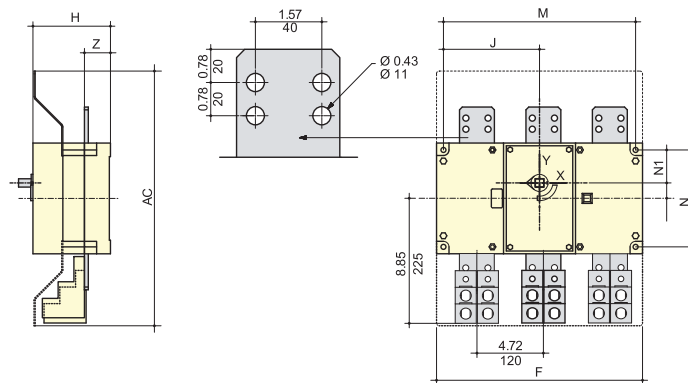

| Rating (A) | Dimensions = in. (mm) | | | | | | | | |
|------------|-----------------------|-------------|-----------|--------------|-------------|------------|-------------|-----------|--|
| | AC | F | H | J | M | N | N1 | Z | |
| 800–1200 | 18.12 (460) | 14.64 (372) | 5.5 (140) | 6.83 (173.5) | 13.66 (347) | 6.88 (175) | 2.34 (59.5) | 1.85 (47) | |

Handle for 800–1200 A Fusible Disconnect Switches

Handle part no.
GS2AH170
GS2AH180

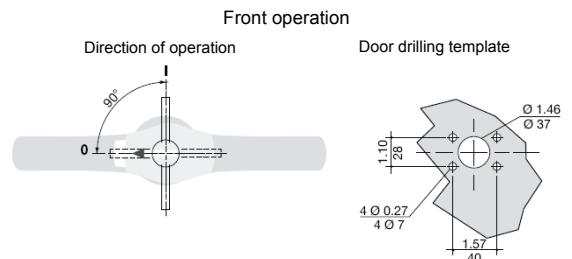
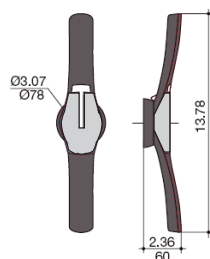

Dimensions: $\frac{\text{in.}}{\text{mm}}$

Manual Motor Control Switches and Disconnects

GS1 and GS2 Fusible and LK4 Nonfusible Disconnect Switches

Handle for 30 A and 60 A Fusible Disconnect Switches

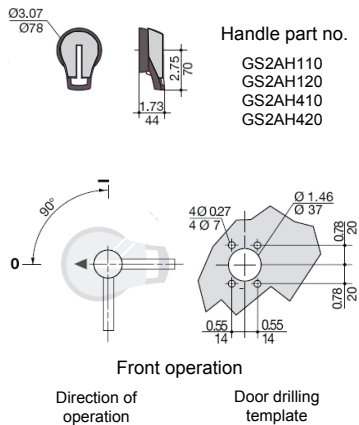

GS1DDU3, 30 A Fusible Disconnect Switches, Class CC Fuses and GS1DU3, 30 A Fusible Disconnect Switches, Class J Fuses—Dimensions

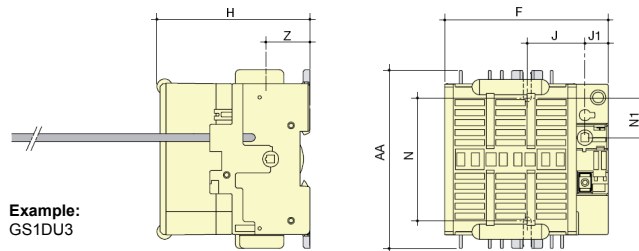

| Rating (A) | Dimensions = in. (mm) | | | | | | | |
|------------|-----------------------|-------------|-------------|-----------|-------------|----------|------------|-------------|
| | F | H | J | J1 | N | N1 | AA | Z |
| 30 / CC | 3.78 (96) | 3.28 (83.5) | 1.47 (37.5) | 0.59 (15) | 3.13 (79.5) | 1 (25.5) | 4.56 (116) | 1.12 (28.5) |
| 30 / J | 4.13 (105) | 3.89 (99) | 1.47 (37.5) | 0.59 (15) | 3.13 (79.5) | 1 (25.5) | 4.56 (116) | 1.12 (28.5) |

GS2EEU3, 30 A Fusible Disconnect Switches, Class CC Fuses

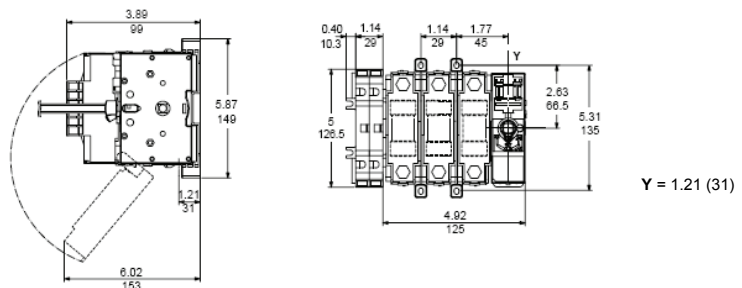
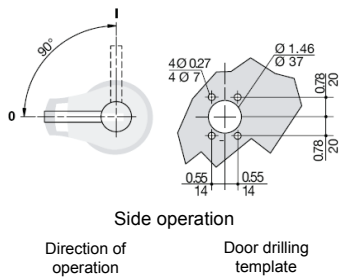

Handle for 100 A, 200 A, and 400 A Fusible Disconnect Switches

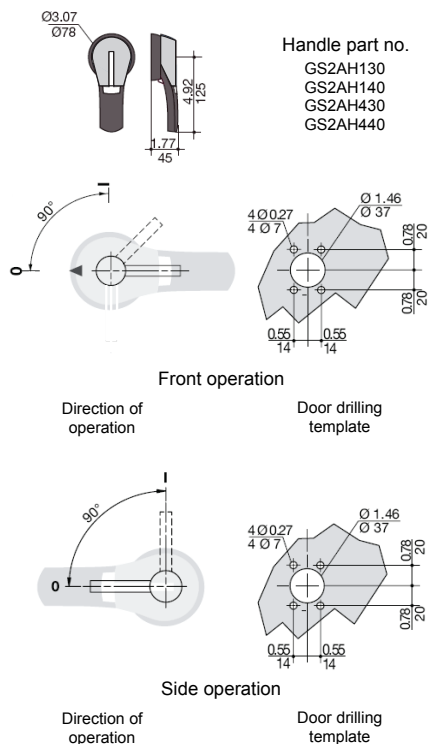

GS2EU3N, 30 A and GS2GU3N, 60 A Fusible Disconnect Switches, Class J Fuses

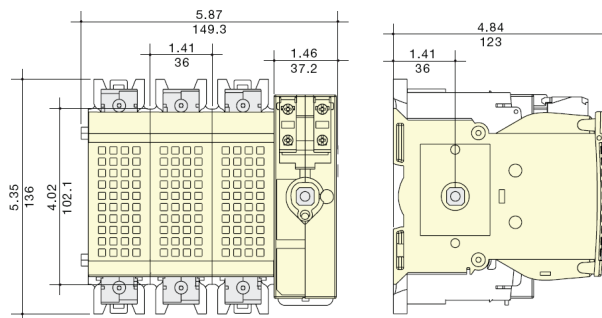

GS2JU3N, 100 A Fusible Disconnect Switches, Class J Fuses

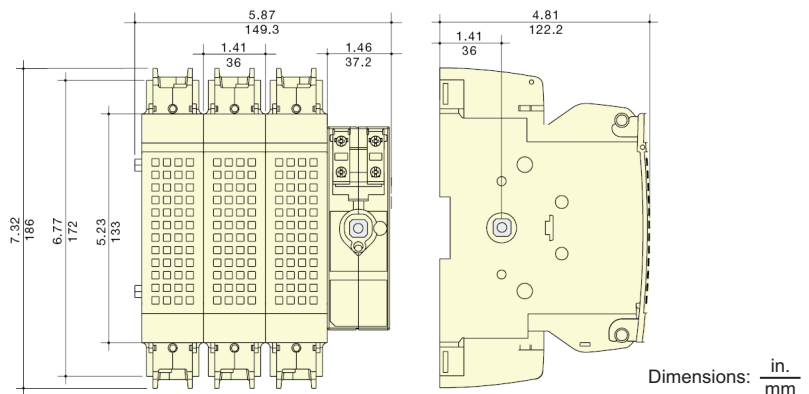

Manual Motor Control Switches and Disconnects

GS1 and GS2 Fusible and LK4 Nonfusible Disconnect Switches

Handle for 100 A, 200 A, and 400 A
Fusible Disconnect Switches

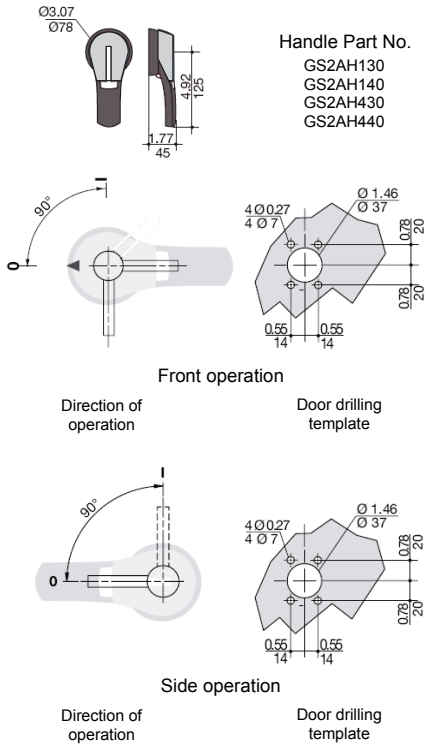

GS2MU3N, 200 A Fusible Disconnect Switches, Class J Fuses

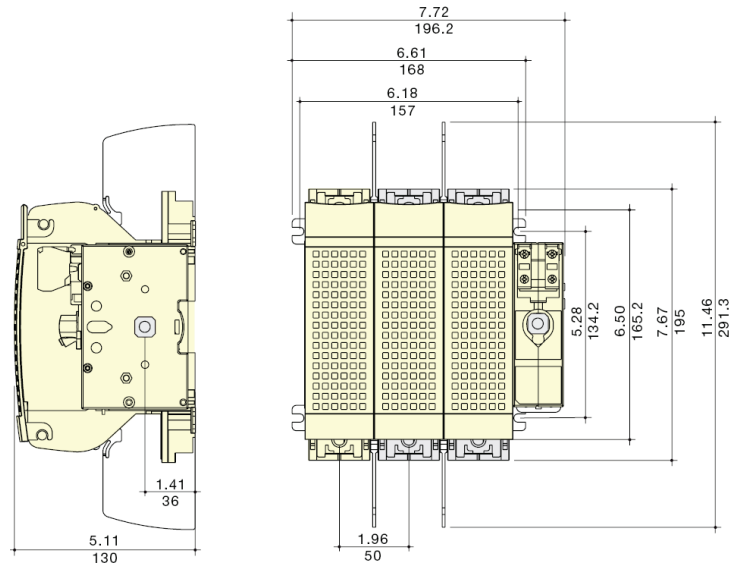

GS2QU3N, 400 A Fusible Disconnect Switches, Class J Fuses

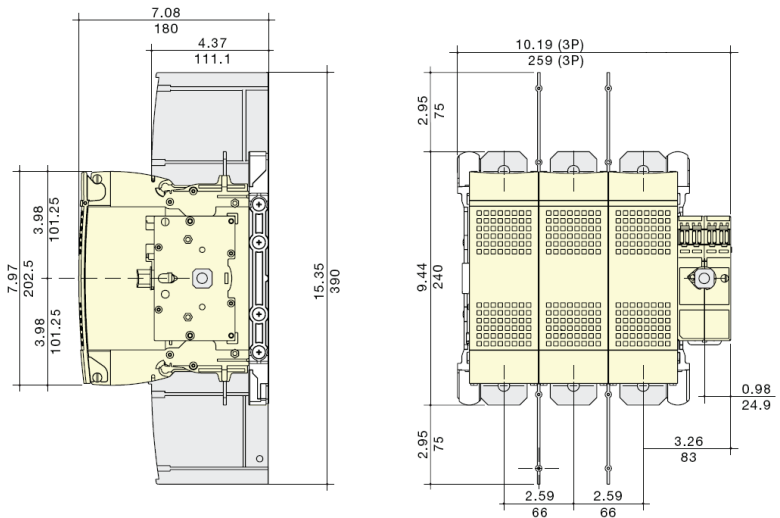

Handle for 600 A and 800 A
Fusible Disconnect Switches

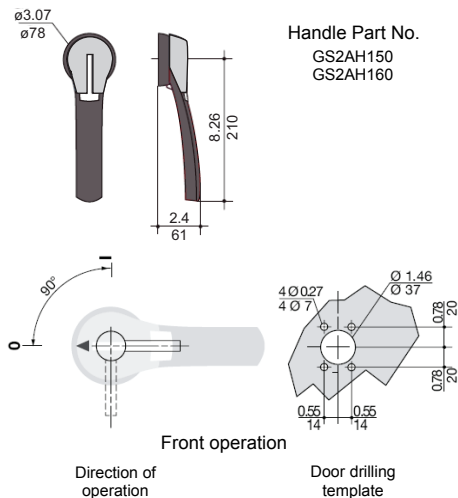

GS2SU3, 600 A Fusible Disconnect Switches, Class J Fuses
GS2TU3, 800 A Fusible Disconnect Switches, Class J Fuses

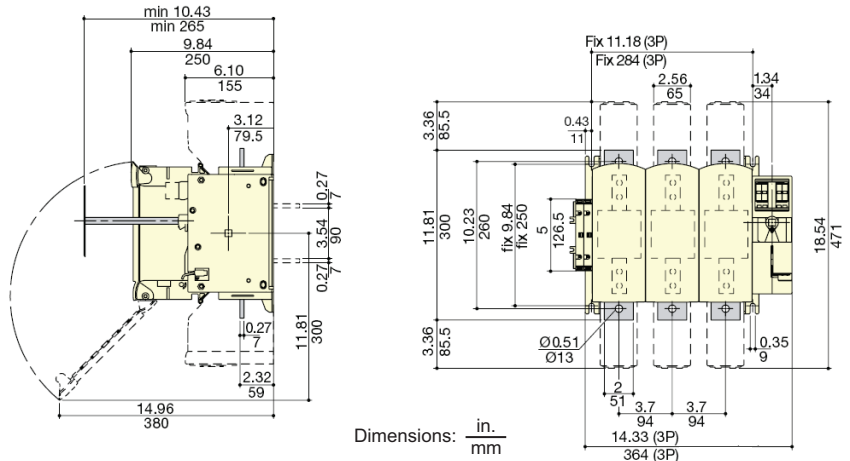

Manual Motor Control Switches and Disconnects

Square D™ MD Enclosed Motor Disconnect Switch

Square D™ MD Enclosed Motor Disconnect Switch



Schneider Electric's Square D brand has been an industry leader in safety switches for over 100 years and is recognized as the market leader in product quality, durability, and reliability. The latest addition to the MD motor disconnect family is a non-receptacle switch for UL 508 listed applications.

This MD motor disconnect switch serves as a local on/off switch for a motor when the motor branch circuit protection is in a central enclosure. It is in a compact NEMA 4X enclosure and is available in 30 A and 60 A versions.

Key Benefits

- Lowers costs—significantly less expensive than stainless steel motor disconnect switches.
- Enhances safety—handle interlock prevents cover from being removed while in the On position.
- Maximizes space—one of smallest footprints on the market.

Key Features

- Water-tight NEMA 4X polycarbonate enclosure—ideal for use in wash down or rugged industrial applications. Covers additional enclosure types, such as NEMA 1, 12, 3R, and 4.
- Standard 3-pole design—optional additional power pole
- Available in 30 A and 60 A sizes
- Horsepower rated
- Clear On/Off indication
- Front padlockable handle complies with OSHA lockout/tagout requirements—accepts up to three 8 mm padlocks
- cULus certified—UL File E164864

Table 45: NEMA 4X Enclosed Switches

| Approvals | Maximum Horsepower Rating | | | Catalog Number |
|-----------|---------------------------|-------------|---------|----------------|
| | Three Phase | | | |
| | 220–240 Vac | 440–480 Vac | 600 Vac | |
| UL 508 | 7.5 | 20 | 25 | MD3304X |
| UL 508 | 20 | 40 | 40 | MD3604X |

Table 46: Accessories

| Description | Catalog Number |
|--|----------------|
| 2 normally open auxiliary contact module | MDSAN20 |
| 1 normally open + 1 normally closed auxiliary contact module | MDSAN11 |
| Additional 30 A power pole | MDS30P |

Manual Motor Control Switches and Disconnects

Square D™ MD Enclosed Motor Disconnect Switch

**30 A Enclosed Switch
Mounting Diagram**

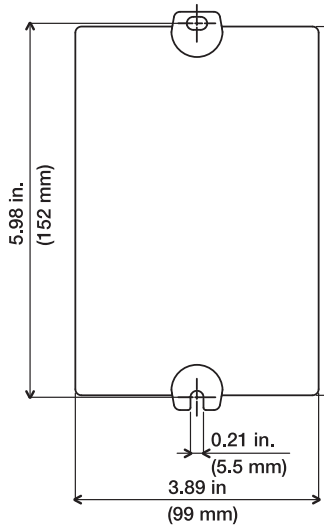

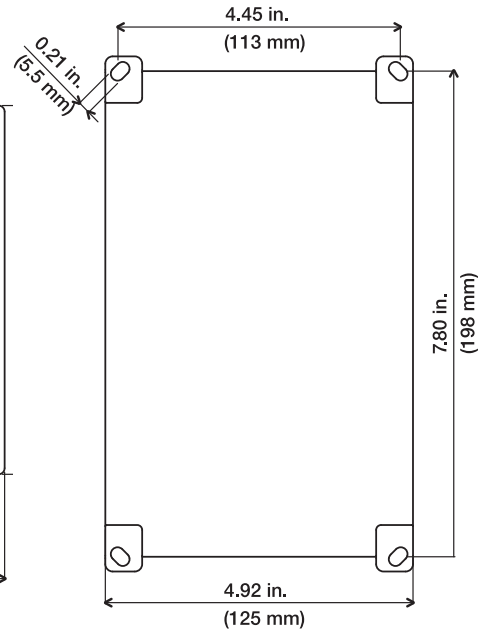

**60 A Enclosed Switch
Mounting Diagram**



TeSys™ DF IEC-Type Fuseholders

Table 47: Specifications

| Fuse Holder Type | | DF8 | DF10 | DF14 | DF22 | DFCC | | | | |
|---|--|--|--|----------------------------------|--------------------|----------------------------------|---|------------------------------------|----------------------------------|----------------------------------|
| Environmental Characteristics | | | | | | | | | | |
| Conforming to standards | | IEC 60947-3, UL 512, CSA 22-2 n° 39 | | | | | | | | |
| Protective treatment | | "TH," treatment for hot and humid environments | | | | | | | | |
| Degree of protection | Conforming to IEC 60529 | IP20 | | | | | | | | |
| Ambient air temperature | Storage | °F (°C) | - 40 to +80 (- 40 to +176) | | | | | | | |
| | Operation, with derating ¹ | °F (°C) | - 20 to +60 (- 4 to +140) | | | | | | | |
| Flame resistance | Conforming to IEC 60695-2-1 | °F (°C) | 960 (1760) | | | | | | | |
| Pole Characteristics | | | | | | | | | | |
| Fuse size | | mm (in.) | 8.5 x 31.5 (0.3 x 1.2) | 10 x 38 (0.4 x 1.5) | 14 x 51 (0.6 x 51) | 22 x 58 (0.9 x 2.3) | 10 x 38 (0.4 x 1.5) CC fuse | | | |
| Use category | | AC20B | | | | | | | | |
| Rated insulation voltage (Ui) with tubular links, AC supply | | V | 500 | 690 | 690 | 690 | 600 | | | |
| Rated operational | | Hz | 50/60 | | | | | | | |
| Rated impulse withstand (Uimp) | | kV | 6 | 6 | 8 | 8 | 6 | | | |
| Conventional thermal current (Ith) for ambient air temperature ≤ 40 °C¹ | | | | | | | | | | |
| | With tubular links | A | 25 | 32 | 50 | 125 | 30 | | | |
| | With aM cartridge fuses | A | 25 | 32 | 50 | 125 | 30 | | | |
| | With gG cartridge fuses | A | 25 | 32 | 50 | 100 | 30 | | | |
| Short circuit characteristics (with tubular links) | | | | | | | | | | |
| | Permissible short-time rating (low) (rms value Cos φ = 0.35) Conforming to IEC 60947-3 | A | 300 | 385 | 800 | 1200 | 300 | | | |
| | Maximum permissible peak value (dynamic stress) Conforming to IEC 60269-1 | kA | 11 | 15 | 15 | 19 | 11 | | | |
| Certifications | | — |  File E310269 CCN IZLT2 File E310269 CCN IZLT8 | | | |  E310269 CCN IZLT | | | |
| Wire sizes (number of conductors x c.s.a.) | | | | | | | | | | |
| | | | Min. | Max. | Min. | Max. | Min. | Max. | Min. | Max. |
| | Solid wire | mm ² (AWG) | 1 x 1.5 (1 x 16) | 1 x 6 (1 x 16) 2 x 6 (2 x 10) | 1 x 1.5 (1 x 16) | 1 x 6 (1 x 16) 2 x 6 (2 x 10) | 1 x 2.5 (1 x 14) 2 x 10 (2 x 8) | 1 x 2.5 (1 x 14) 2 x 10 (2 x 8) | 1 x 35 (1 x 2) 2 x 25 (2 x 4) | 1 x 6 (1 x 16) 2 x 6 (2 x 10) |
| | Flexible wire without cable end | mm ² (AWG) | 1 x 1.5 (1 x 16) | 1 x 6 (1 x 16) 2 x 6 (2 x 10) | 1 x 1.5 (1 x 16) | 1 x 6 (1 x 16) 2 x 6 (2 x 10) | 1 x 2.5 (1 x 14) 2 x 10 (2 x 8) | 1 x 2.5 (1 x 14) 2 x 10 (2 x 8) | 1 x 35 (1 x 2) 2 x 25 (2 x 4) | 1 x 6 (1 x 16) 2 x 6 (2 x 10) |
| | Flexible wire with cable end | mm ² (AWG) | 1 x 1.5 (1 x 16) | 1 x 6 (1 x 16) 2 x 6 (2 x 10) | 1 x 1.5 (1 x 16) | 1 x 6 (1 x 16) 2 x 6 (2 x 10) | 1 x 2.5 (1 x 14) 2 x 10 (2 x 8) | 1 x 2.5 (1 x 14) 2 x 10 (2 x 8) | 1 x 35 (1 x 2) 2 x 25 (2 x 4) | 1 x 6 (1 x 16) 2 x 6 (2 x 10) |
| Tightening torque | | N·m (lb-in) | 2.2 (19) | | 3.5 (31) | | 4 (35) | | 2.2 (19) | |

¹ For use in an installation with ambient temp. > 20 °C (68 °F), apply the derating coefficient from Table 49 on page 42.

Manual Motor Control Switches and Disconnects

TeSys™ DF IEC-Type Fuseholders

Table 48: Characteristics of early break and signaling contacts DF14AM and DF22AM

| | | | | | | |
|---|-----------------------------|----|-------------------|-------------|--------------|--------------|
| Rated insulation voltage (Ui) a.c. supply | | V | 250 | | | |
| Conventional thermal current (Ith) for ambient air temperature ≤ 40 °C ¹ | | A | 5 | | | |
| Rated operational current | | | 24 V | 48 V | 127 V | 240 V |
| | Category AC-15 | A | 4 | 4 | 3 | 2.5 |
| | Category DC-13 | A | 3 | 1 | 0.2 | 0.1 |
| Definition of rated characteristics | Conforming to IEC 60947-5-1 | | B300 | | | |
| Low load operating characteristics | Minimum voltage | V | 10 | | | |
| | Minimum current | mA | 30 | | | |
| Cabling | | | Faston connectors | | | |

¹ For use in an installation with ambient temp. > 20 °C (68 °F), apply the derating coefficient from Table 49.

Table 49: Derating Coefficients

| | | | | | |
|------------------------------|---------|---------|----------|----------|----------|
| Max temperature °C (°F) | 20 (68) | 30 (86) | 40 (104) | 50 (122) | 60 (140) |
| Max. relative humidity | 95% | 90% | 80% | 50% | 50% |
| Current derating coefficient | 1 | 0.95 | 0.9 | 0.8 | 0.7 |

Manual Motor Control Switches and Disconnects

TeSys™ DF IEC-Type Fuseholders

Table 50: Fuseholders¹



DF101



DF103N



DF141



DF141NC



DF221



DF223NC



DF101NV



DF103V



DF141NV



DF143VC



DF221NV



DF223VC

| Conventional thermal current (Ith) A | Size of cartridge fuse or link mm (in.) | Composition P = Poles N = Neutral | Sold in lots of | Catalog number | Weight kg (oz) |
|--|--|---|-----------------|----------------------------|-------------------|
| 25 | 8.5 x 31.5 (0.3 x 1.2) | 1 P | 12 | DF81 | 0.061 (2.15) |
| | | N | 12 | DF10N | 0.071 (2.50) |
| | | 1 P + N ² | 6 | DF81N | 0.132 (4.66) |
| | | 2 P | 6 | DF82 | 0.122 (4.30) |
| | | 3 P | 4 | DF83 | 0.183 (6.46) |
| 32 | 10 x 38 (0.4 x 1.5) | 3 P + N ² | 3 | DF83N | 0.254 (8.96) |
| | | 1 P | 12 | DF101 | 0.061 (2.15) |
| | | N | 12 | DF10N | 0.071 (2.50) |
| | | 1 P + N ² | 6 | DF101N | 0.132 (4.66) |
| | | 2 P | 6 | DF102 | 0.122 (4.30) |
| 50 | 14 x 51 (0.6 x 2.0) | 3 P | 4 | DF103 | 0.183 (6.46) |
| | | 3 P + N ² | 3 | DF103N | 0.254 (8.96) |
| | | 1 P | 6 | DF141 | 0.140 (4.94) |
| | | N | 6 | DF14N | 0.150 (5.29) |
| | | 1 P + N ² | 3 | DF141N | 0.290 (10.23) |
| 125 | 22 x 58 (0.9 x 2.3) | 2 P | 3 | DF142 | 0.280 (9.88) |
| | | 3 P | 2 | DF143C³ | 0.420 (14.82) |
| | | 3 P + N ² | 1 | DF143NC³ | 0.570 (20.11) |
| | | 1 P | 6 | DF221 | 0.218 (7.69) |
| | | N | 6 | DF22N | 0.238 (8.40) |
| | | 1 P + N ² | 3 | DF221N | 0.456 (16.09) |
| | | 2 P | 3 | DF222 | 0.436 (15.38) |
| | | 3 P | 2 | DF223C³ | 0.654 (23.07) |
| | | 3 P + N ² | 1 | DF223NC³ | 0.892 (31.46) |

Fuseholders with blown fuse indicators (neon)^{1,4}

| | | | | | |
|-----|---------------------------|----------------------|----|-----------------------------|---------------|
| 25 | 8.5 x 31.5 (0.3 x 1.2) | 1 P | 12 | DF81V | 0.064 (2.26) |
| | | 1 P + N ² | 6 | DF81NV | 0.135 (4.76) |
| | | 2 P | 6 | DF82V | 0.125 (4.41) |
| | | 3 P | 4 | DF83V | 0.186 (6.56) |
| 32 | 10 x 38 (0.4 x 1.5) | 3 P + N ² | 3 | DF83NV | 0.257 (9.07) |
| | | 1 P | 12 | DF101V | 0.064 (2.26) |
| | | 1 P + N ² | 6 | DF101NV | 0.135 (4.76) |
| | | 2 P | 6 | DF102V | 0.125 (4.41) |
| 50 | 14 x 51 (0.6 x 2.0) | 3 P | 4 | DF103V | 0.186 (6.56) |
| | | 3 P + N ² | 3 | DF103NV | 0.257 (9.07) |
| | | 1 P | 6 | DF141V | 0.143 (5.04) |
| | | 1 P + N ² | 3 | DF141NV | 0.293 (10.34) |
| 125 | 22 x 58 (0.9 x 2.3) | 2 P | 3 | DF142V | 0.283 (9.98) |
| | | 3 P | 2 | DF143VC³ | 0.423 (14.92) |
| | | 3 P + N ² | 1 | DF143NVC³ | 0.573 (20.21) |
| | | 1 P | 6 | DF221V | 0.221 (7.80) |
| | | 1 P + N ² | 3 | DF221NV | 0.459 (16.19) |
| | | 2 P | 3 | DF222V | 0.439 (15.49) |
| | | 3 P | 2 | DF223VC³ | 0.657 (23.18) |
| | | 3 P + N ² | 1 | DF223NVC³ | 0.895 (31.57) |

¹ Each pole can be marked. A clip-in marker holder is provided for this purpose. Clip-in markers type AB1 R• or AB1 G• can also be used.

² N: neutral pole fitted with a locked tubular link as standard.

³ A letter "C" in the catalog number indicates that the fuseholder can be fitted with auxiliary early break, blown fuse signaling, and fuse present signaling contacts.

⁴ Operational voltage of the blown fuse indicator: 110–690 V.

Manual Motor Control Switches and Disconnects

TeSys™ DF IEC-Type Fuseholders



DFCC1V



DFCC3V

Table 51: Fuseholders¹

| Conventional thermal current (Ith) | Size of cartridge fuse or link | Composition P = Poles | Sold in lots of | Catalog number | Weight kg (oz) |
|------------------------------------|--------------------------------|-----------------------|-----------------|----------------|-------------------|
| A | | | | | |
| 30 | Class CC | 1 P | 12 | DFCC1 | 0.061 (2.15) |
| | | 2 P | 6 | DFCC2 | 0.122 (4.30) |
| | | 3 P | 4 | DFCC3 | 0.183 (6.46) |

Fuseholders with blown fuse indicators (neon)¹

| | | | | | |
|----|----------|-----|----|--------|--------------|
| 30 | Class CC | 1 P | 12 | DFCC1V | 0.064 (2.26) |
| | | 2 P | 6 | DFCC2V | 0.125 (4.41) |
| | | 3 P | 4 | DFCC3V | 0.186 (6.56) |

¹ Each pole can be marked. A clip-in marker holder is provided for this purpose. Clip-in markers type AB1 R• or AB1 G• can also be used.

Table 52: Auxiliary early break and blown fuse signaling contacts¹

| | Size of cartridge fuse or link mm (in.) | Number of contacts | Sold in lots of | Catalog number | Weight kg (oz) |
|------|--|--------------------|-----------------|----------------|-------------------|
| DF14 | 14 x 51 (0.6 x 2.0) | 1 | 1 | DF14AM1 | 0.025 (0.88) |
| | | 2 | 1 | DF14AM2 | 0.029 (1.02) |
| DF22 | 22 X 58 (0.9 x 2.3) | 1 | 1 | DF22AM1 | 0.032 (1.13) |
| | | 2 | 1 | DF22AM2 | 0.035 (1.23) |

¹ These auxiliary contacts provide the following functions: early break, blown fuse signaling (if the Fuseholder is fitted with striker fuses) and fuse present signaling.



DF14AM•

Table 53: Fuseholder Assembly Kits¹

| Fuseholders to be assembled | Size of cartridge fuse or link mm (in.) | Composition | Sold in lots of | Catalog number | Weight kg (oz) |
|-----------------------------|--|-------------------|-----------------|----------------|-------------------|
| DF8 | 8.5 x 31.5 (0.3 x 1.2) | 12 pins, 24 clips | 12 | DF10AP | 0.007 (0.25) |
| DF10 | 10 x 38 (0.4 x 1.5) | | | | |
| DF14 | 14 x 51 (0.6 x 2.0) | 10 pins, 30 clips | 10 | DF14AP | 0.025 (0.88) |
| DF22 | 22 X 58 (0.9 x 2.3) | 10 pins, 30 clips | 10 | DF22AP | 0.028 (0.99) |

¹ 1 pin and 2 clips are required to assemble two DF8 or DF10 fuseholders together.
1 pin and 3 clips are required to assemble two DF14 or DF22 fuseholders together.

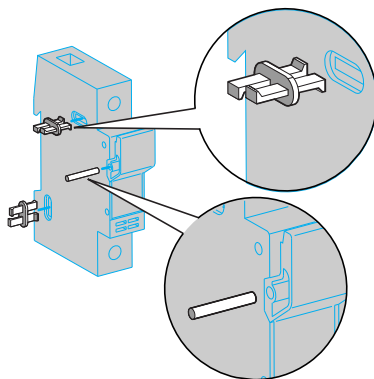

Detail of assembly clip and pin mounting

Table 54: Marking Accessories

| Description | Composition | Marking | Sold in lots of | Catalog number | Weight kg (oz) |
|-----------------|--|---------|-----------------|--------------------|-------------------|
| Clip-in markers | Strip of 10 identical numbers or letters | 0-9 | 25 | AB1R• ¹ | 0.002 (0.07) |
| | | A-Z | 25 | AB1G• ¹ | 0.002 (0.07) |

¹ When ordering, replace the • in the catalog number with the number or letter required. Example: AB1-R1 or AB1-GA.

DF10 and DFCC fuseholders have been subjected to a current withstand of I_p = 9 kA and 12T = 38 kA2s at 800 Vac maximum, 200 kA.

DF14 fuseholders have been subjected to a current withstand of I_p = 24.2 kA and 12T = 130 kA2s at 750 Vac maximum, 200 kA.

DF22 fuseholders have been subjected to a current withstand of I_p = 20.4 kA and 12T = 141 kA2s at 750 Vac maximum, 200 kA.

DF10, DF14, and DF22 devices accept fuses which provide supplementary protection and have not been evaluated by UL for use where branch circuit protection is needed.

Manual Motor Control Switches and Disconnects TeSys™ DF IEC-Type Fuseholders

Dimensions

Modular fuseholders 25 A and 32 A
Mounting on 35 mm DIN rail

DF81 and DF81V
DF101 and DF101V
DF10N
DFCC1 and DFCC1V

DF81N and DF81NV
DF82 and DF82V
DF101N and DF101NV
DF102 and DF102V
DFCC2 and DFCC2V

DF83 and DF83V
DF103 and DF103V
DFCC3 and DFCC3V

DF83N and DF83NV
DF103N and DF103NV

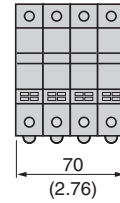
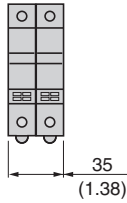
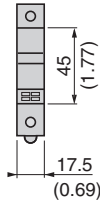
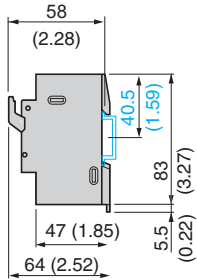

Modular fuseholders 50 A
Mounting on 35 mm DIN rail

DF141 and DF141V
DF14N

DF141N and DF141NV
DF142 and DF142V

DF143C and DF143VC

DF143NC and DF143NV

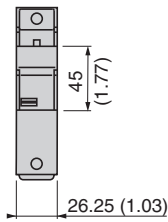
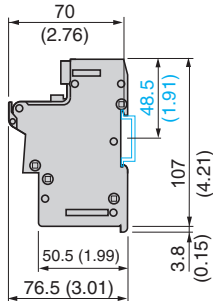

Modular fuseholders 125 A
Mounting on 35 mm DIN rail

DF221 and DF221V
DF22N

DF221N and DF221NV
DF222 and DF222V

DF223C and DF223VC

DF223NC and DF223NV

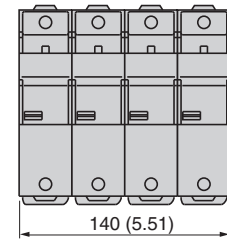
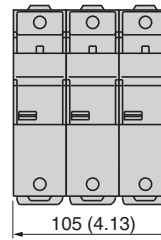
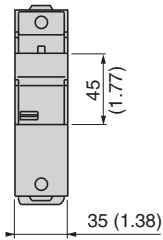
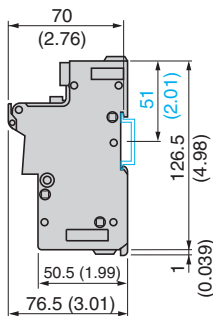

Wiring diagrams

Modular fuseholders

DF•1P



DF•N

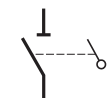

DF•1P + N

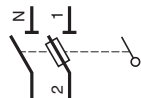

DF•2P

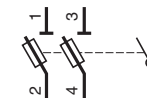

DF•3P

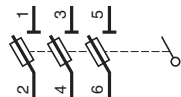

DF•3P + N

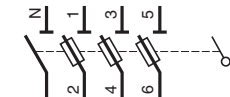

Manual Motor Control Switches and Disconnects

TeSys™ DF IEC-Type Fuseholders

Table 55: Cartridge fuses without striker—Type aM

| Cartridge fuse type mm (in.) | Maximum rated voltage Vac | Rating A | Sold in lots of | Catalog Number | Weight g (oz) | | | |
|--|------------------------------|---------------------------------------|-----------------|----------------|------------------|----------|----------|-----------|
| Cylindrical 8.5 x 31.5 (0.3 x 1.2) | 400 | 1 | 10 | DF2BA0100 | 10 (0.35) | | | |
| | | 2 | 10 | DF2BA0200 | | | | |
| | | 4 | 10 | DF2BA0400 | | | | |
| | | 6 | 10 | DF2BA0600 | | | | |
| | | 8 | 10 | DF2BA0800 | | | | |
| | | 10 | 10 | DF2BA1000 | | | | |
| Cylindrical 10 x 38 (0.4 x 1.5) | 500 | 0.16 | 10 | DF2CA001 | 0.35 (10) | | | |
| | | 0.25 | 10 | DF2CA002 | | | | |
| | | 0.50 | 10 | DF2CA005 | | | | |
| | | 1 | 10 | DF2CA01 | | | | |
| | | 2 | 10 | DF2CA02 | | | | |
| | | 4 | 10 | DF2CA04 | | | | |
| | | 6 | 10 | DF2CA06 | | | | |
| | | 8 | 10 | DF2CA08 | | | | |
| | | 10 | 10 | DF2CA10 | | | | |
| | | 12 | 10 | DF2CA12 | | | | |
| | 16 | 10 | DF2CA16 | | | | | |
| | 400 | 20 | 10 | DF2CA20 | | | | |
| | | 25 | 10 | DF2CA25 | | | | |
| | | Cylindrical 14 x 51 (0.6 x 2.0) | 500 | 0.25 | | 10 | DF2EA002 | 20 (0.71) |
| | | | | 0.50 | | 10 | DF2EA005 | |
| | | | | 1 | | 10 | DF2EA01 | |
| 2 | | | | 10 | DF2EA02 | | | |
| 4 | 10 | | | DF2EA04 | | | | |
| 6 | 10 | | | DF2EA06 | | | | |
| 8 | 10 | | | DF2EA08 | | | | |
| 10 | 10 | | | DF2EA10 | | | | |
| 12 | 10 | | | DF2EA12 | | | | |
| 16 | 10 | | | DF2EA16 | | | | |
| 20 | 10 | | | DF2EA20 | | | | |
| 25 | 10 | | | DF2EA25 | | | | |
| 32 | 10 | | | DF2EA32 | | | | |
| 40 | 10 | | | DF2EA40 | | | | |
| 400 | 50 | 10 | DF2EA50 | | | | | |
| Cylindrical 22 x 58 (0.9 x 2.3) | 690 | 4 | 10 | DF2FA04 | 45 (1.59) | | | |
| | | 6 | 10 | DF2FA06 | | | | |
| | | 8 | 10 | DF2FA08 | | | | |
| | | 10 | 10 | DF2FA10 | | | | |
| | | 16 | 10 | DF2FA16 | | | | |
| | | 20 | 10 | DF2FA20 | | | | |
| | | 25 | 10 | DF2FA25 | | | | |
| | | 32 | 10 | DF2FA32 | | | | |
| | | 40 | 10 | DF2FA40 | | | | |
| | | 50 | 10 | DF2FA50 | | | | |
| | 500 | 63 | 10 | DF2FA63 | | | | |
| | | 80 | 10 | DF2FA80 | | | | |
| | | 100 | 10 | DF2FA100 | | | | |
| | | 400 | 125 | 10 | | DF2FA125 | | |



DF2CA***

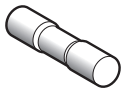

DF2EA***

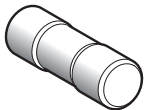

DF2FA***

Manual Motor Control Switches and Disconnects

TeSys™ DF IEC-Type Fuseholders

Table 56: Cartridge fuses with striker—Type aM

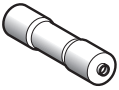
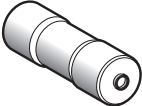
| Cartridge fuse type mm (in.) | Maximum rated voltage V~ | Rating A | Standard Pack Quantity | Catalog Number | Weight g (oz) |
|---|--|-------------|------------------------|----------------|------------------|
|  Cylindrical 14 x 51 (0.6 x 2.0) DF3EA** | 500 | 2 | 10 | DF3EA02 | 20 (0.71) |
| | | 4 | 10 | DF3EA04 | |
| | | 6 | 10 | DF3EA06 | |
| | | 8 | 10 | DF3EA08 | |
| | | 10 | 10 | DF3EA10 | |
| | | 12 | 10 | DF3EA12 | |
| | | 16 | 10 | DF3EA16 | |
| | | 20 | 10 | DF3EA20 | |
| | | 25 | 10 | DF3EA25 | |
| | | 32 | 10 | DF3EA32 | |
| | 40 | 10 | DF3EA40 | | |
| | 400 | 50 | 10 | DF3EA50 | 20 (0.71) |
| |  Cylindrical 22 x 58 (0.9 x 2.3) DF3FA*** | 690 | 4 | 10 | DF3FA04 |
| 6 | | | 10 | DF3FA06 | |
| 8 | | | 10 | DF3FA08 | |
| 10 | | | 10 | DF3FA10 | |
| 16 | | | 10 | DF3FA16 | |
| 20 | | | 10 | DF3FA20 | |
| 25 | | | 10 | DF3FA25 | |
| 32 | | | 10 | DF3FA32 | |
| 40 | | | 10 | DF3FA40 | |
| 50 | | | 10 | DF3FA50 | |
| 500 | | 63 | 10 | DF3FA63 | 45 (1.59) |
| | | 80 | 10 | DF3FA80 | |
| | | 100 | 10 | DF3FA100 | |
| 400 | | 125 | 10 | DF3FA125 | 45 (1.59) |

INDEX

Numerics

| | |
|-----------|----|
| 9421V1A30 | 13 |
| 9421V1G30 | 13 |
| 9421V1W30 | 13 |
| 9421V2A30 | 13 |
| 9421V2G30 | 13 |
| 9421V2W30 | 13 |

A

| | |
|-------|----|
| AB1G• | 44 |
| AB1R• | 44 |

D

| | |
|-----------|----|
| DF101 | 43 |
| DF101N | 43 |
| DF101NV | 43 |
| DF101V | 43 |
| DF102 | 43 |
| DF102V | 43 |
| DF103 | 43 |
| DF103N | 43 |
| DF103NV | 43 |
| DF103V | 43 |
| DF10AP | 44 |
| DF10N | 43 |
| DF141 | 43 |
| DF141N | 43 |
| DF141NV | 43 |
| DF141V | 43 |
| DF142 | 43 |
| DF142V | 43 |
| DF143C | 43 |
| DF143NC | 43 |
| DF143NVC | 43 |
| DF143VC | 43 |
| DF14AM1 | 44 |
| DF14AM2 | 44 |
| DF14AP | 44 |
| DF14N | 43 |
| DF221 | 43 |
| DF221N | 43 |
| DF221NV | 43 |
| DF221V | 43 |
| DF222 | 43 |
| DF222V | 43 |
| DF223C | 43 |
| DF223NC | 43 |
| DF223NVC | 43 |
| DF223VC | 43 |
| DF22AM1 | 44 |
| DF22AM2 | 44 |
| DF22AP | 44 |
| DF22N | 43 |
| DF2BA0100 | 46 |
| DF2BA0200 | 46 |
| DF2BA0400 | 46 |
| DF2BA0600 | 46 |
| DF2BA0800 | 46 |
| DF2BA1000 | 46 |
| DF2CA001 | 46 |

| | |
|----------|----|
| DF2CA002 | 46 |
| DF2CA005 | 46 |
| DF2CA01 | 46 |
| DF2CA02 | 46 |
| DF2CA04 | 46 |
| DF2CA06 | 46 |
| DF2CA08 | 46 |
| DF2CA10 | 46 |
| DF2CA12 | 46 |
| DF2CA16 | 46 |
| DF2CA20 | 46 |
| DF2CA25 | 46 |
| DF2EA002 | 46 |
| DF2EA005 | 46 |
| DF2EA01 | 46 |
| DF2EA02 | 46 |
| DF2EA04 | 46 |
| DF2EA06 | 46 |
| DF2EA08 | 46 |
| DF2EA10 | 46 |
| DF2EA12 | 46 |
| DF2EA16 | 46 |
| DF2EA20 | 46 |
| DF2EA25 | 46 |
| DF2EA32 | 46 |
| DF2EA40 | 46 |
| DF2EA50 | 46 |
| DF2FA04 | 46 |
| DF2FA06 | 46 |
| DF2FA08 | 46 |
| DF2FA10 | 46 |
| DF2FA100 | 46 |
| DF2FA125 | 46 |
| DF2FA16 | 46 |
| DF2FA20 | 46 |
| DF2FA25 | 46 |
| DF2FA32 | 46 |
| DF2FA40 | 46 |
| DF2FA50 | 46 |
| DF2FA63 | 46 |
| DF2FA80 | 46 |
| DF3EA02 | 47 |
| DF3EA04 | 47 |
| DF3EA06 | 47 |
| DF3EA08 | 47 |
| DF3EA10 | 47 |
| DF3EA12 | 47 |
| DF3EA16 | 47 |
| DF3EA20 | 47 |
| DF3EA25 | 47 |
| DF3EA32 | 47 |
| DF3EA40 | 47 |
| DF3EA50 | 47 |
| DF3FA04 | 47 |
| DF3FA06 | 47 |
| DF3FA08 | 47 |
| DF3FA10 | 47 |
| DF3FA100 | 47 |
| DF3FA125 | 47 |
| DF3FA16 | 47 |
| DF3FA20 | 47 |

| | |
|---------|----|
| DF3FA25 | 47 |
| DF3FA32 | 47 |
| DF3FA40 | 47 |
| DF3FA50 | 47 |
| DF3FA63 | 47 |
| DF3FA80 | 47 |
| DF81 | 43 |
| DF81N | 43 |
| DF81NV | 43 |
| DF81V | 43 |
| DF82 | 43 |
| DF82V | 43 |
| DF83 | 43 |
| DF83N | 43 |
| DF83NV | 43 |
| DF83V | 43 |
| DFCC1 | 44 |
| DFCC1V | 44 |
| DFCC2 | 44 |
| DFCC2V | 44 |
| DFCC3 | 44 |
| DFCC3V | 44 |

G

| | |
|-----------|--------|
| GS1AD10 | 33 |
| GS1AP33 | 33 |
| GS1AU203 | 33 |
| GS1AU303 | 33 |
| GS1AU403 | 33 |
| GS1AU503 | 33 |
| GS1AU803 | 33 |
| GS1AW306 | 34 |
| GS1AW403 | 34 |
| GS1AW406 | 34 |
| GS1AW503 | 34 |
| GS1AW506 | 34 |
| GS1AW603 | 34 |
| GS1AW606 | 34 |
| GS1DDU3 | 28, 30 |
| GS1DU3 | 28, 30 |
| GS2AH110 | 32 |
| GS2AH120 | 32 |
| GS2AH120F | 30 |
| GS2AH130 | 32 |
| GS2AH140 | 32 |
| GS2AH144F | 30 |
| GS2AH150 | 32 |
| GS2AH160 | 32 |
| GS2AH170 | 32 |
| GS2AH180 | 32 |
| GS2AH180F | 30 |
| GS2AH36F | 30 |
| GS2AH410 | 32 |
| GS2AH420 | 32 |
| GS2AH430 | 32 |
| GS2AH440 | 32 |
| GS2AH60F | 30 |
| GS2AM101 | 33–34 |
| GS2AM110 | 33–34 |
| GS2AP43 | 33 |
| GS2AP53 | 33 |

| | |
|---------|--------|
| GS2AP73 | 33 |
| GS2EEU3 | 28, 30 |
| GS2EU3N | 28, 30 |
| GS2GU3N | 28, 30 |
| GS2JU3N | 28, 30 |
| GS2MU3N | 28, 30 |
| GS2QU3N | 28, 30 |
| GS2SU3 | 28, 30 |
| GS2TU3 | 28, 30 |

K

| | |
|--------|--------|
| KAC1BZ | 17 |
| KAD1PZ | 10, 19 |
| KAD1XZ | 19 |
| KAE1BZ | 17 |
| KAF1PZ | 19 |
| KAF1XZ | 19 |
| KAF2PZ | 19 |
| KAF2XZ | 19 |
| KAF3PZ | 19 |
| KAG2XZ | 19 |
| KBD1PZ | 17 |
| KBF1PZ | 17 |
| KBF2PZ | 17 |
| KBF3PZ | 17 |
| KCC1LZ | 17 |
| KCC1YZ | 10, 19 |
| KCD1PZ | 10, 19 |
| KCD1YZ | 19 |
| KCE1LZ | 17 |
| KCE1YZ | 19 |
| KCF1PZ | 19 |
| KCF1YZ | 19 |
| KCF2PZ | 19 |
| KCF2YZ | 19 |
| KCF3PZ | 19 |
| KCG2YZ | 19 |
| KDD1PZ | 17 |
| KDF1PZ | 17 |
| KDF2PZ | 17 |
| KDF3PZ | 17 |
| KZ100 | 20 |
| KZ101 | 20 |
| KZ103 | 20 |
| KZ106 | 20 |
| KZ13 | 20 |
| KZ14 | 20 |
| KZ15 | 20 |
| KZ16 | 20 |
| KZ32 | 10, 20 |
| KZ62 | 20 |
| KZ65 | 20 |
| KZ66 | 20 |
| KZ67 | 20 |
| KZ74 | 20 |
| KZ76 | 20 |
| KZ77 | 20 |
| KZ81 | 20 |
| KZ83 | 10, 20 |

L

| | |
|------------|--------|
| LK4AD10N | 34 |
| LK4AD20N | 34 |
| LK4AD30N | 34 |
| LK4AH110CN | 32 |
| LK4AH120CN | 32 |
| LK4AH410CN | 32 |
| LK4AH420CN | 32 |
| LK4AP33BN | 34 |
| LK4AP33TN | 34 |
| LK4AP3CN | 34 |
| LK4AP53BN | 34 |
| LK4AP53TN | 34 |
| LK4AP63N | 34 |
| LK4DU3CN | 29, 31 |
| LK4DUKB1 | 32 |
| LK4DUKB4 | 32 |
| LK4DUKR1 | 32 |
| LK4DUKR4 | 32 |
| LK4GU3CN | 29, 31 |
| LK4GUKB1 | 32 |
| LK4GUKB4 | 32 |
| LK4GUKR1 | 32 |
| LK4GUKR4 | 32 |
| LK4JU3CN | 29, 31 |
| LK4JU3N | 29, 31 |
| LK4JUKB1 | 32 |
| LK4JUKB4 | 32 |
| LK4JUKR1 | 32 |
| LK4JUKR4 | 32 |
| LK4MU3N | 29, 31 |
| LK4QU3N | 29, 31 |
| LK4SU3N | 29, 31 |
| LK4TU3N | 29, 31 |
| LK4UU3N | 29, 31 |
| LK4WU3N | 29, 31 |

M

| | |
|---------|--------|
| MD3304X | 39 |
| MD3604X | 39 |
| MDS30P | 39 |
| MDSAN11 | 34, 39 |
| MDSAN20 | 34, 39 |

V

| | |
|--------|----|
| V0 | 15 |
| V01 | 15 |
| V02 | 15 |
| V1 | 15 |
| V2 | 15 |
| V3 | 15 |
| V4 | 15 |
| V5 | 15 |
| V6 | 15 |
| VBDO | 12 |
| VBDO1 | 12 |
| VBDO2 | 12 |
| VBD1 | 12 |
| VBD2 | 12 |
| VBDN12 | 8 |

Manual Motor Control Switches and Disconnects Index

| | | | |
|---------|----|----------|--------|
| VBDN20 | 8 | VCFN12GE | 8 |
| VBF0 | 12 | VCFN20GE | 8 |
| VBF01 | 12 | VN12 | 9 |
| VBF01GE | 14 | VN20 | 9 |
| VBF02 | 12 | VVD0 | 12 |
| VBF02GE | 14 | VVD1 | 12 |
| VBF0GE | 14 | VVD2 | 12 |
| VBF1 | 12 | VVD3 | 12 |
| VBF1GE | 14 | VVD4 | 12 |
| VBF2 | 12 | VVE0 | 12 |
| VBF2GE | 14 | VVE1 | 12 |
| VBF3 | 12 | VVE2 | 12 |
| VBF3GE | 14 | VVE3 | 12 |
| VBF4 | 12 | VVE4 | 12 |
| VBF4GE | 14 | VZ0 | 15 |
| VBF5 | 12 | VZ01 | 15 |
| VBF5GE | 14 | VZ02 | 15 |
| VBF6 | 12 | VZ1 | 15 |
| VBF6GE | 14 | VZ10 | 19 |
| VC1GUN | 13 | VZ11 | 15 |
| VC2GUN | 13 | VZ12 | 15 |
| VC3GUN | 13 | VZ13 | 15 |
| VC4GUN | 13 | VZ14 | 15 |
| VC5GUN | 13 | VZ15 | 15 |
| VC6GUN | 13 | VZ16 | 15 |
| VCCD0 | 11 | VZ17 | 20 |
| VCCD01 | 11 | VZ18 | 20 |
| VCCD02 | 11 | VZ2 | 15 |
| VCCD1 | 11 | VZ20 | 15 |
| VCCD2 | 11 | VZ26 | 19 |
| VCCDN12 | 8 | VZ27 | 19 |
| VCCDN20 | 8 | VZ28 | 19 |
| VCCF0 | 11 | VZ29 | 19 |
| VCCF01 | 11 | VZ3 | 15 |
| VCCF02 | 11 | VZ30 | 20 |
| VCCF1 | 11 | VZ31 | 20 |
| VCCF2 | 11 | VZ4 | 15 |
| VCCF3 | 11 | VZ7 | 15 |
| VCCF4 | 11 | VZ8 | 19 |
| VCCF5 | 11 | VZ9 | 19 |
| VCCF6 | 11 | VZN05 | 9 |
| VCD0 | 11 | VZN06 | 9 |
| VCD01 | 11 | VZN08 | 9 |
| VCD02 | 11 | VZN11 | 9 |
| VCD1 | 11 | VZN12 | 9 |
| VCD2 | 11 | VZN14 | 9 |
| VCDN12 | 8 | VZN17 | 10, 20 |
| VCDN20 | 8 | VZN20 | 9 |
| VCF0 | 11 | VZN26 | 9 |
| VCF01 | 11 | VZN30 | 10, 20 |
| VCF01GE | 13 | | |
| VCF02 | 11 | Z | |
| VCF02GE | 13 | Z01 | 20 |
| VCF0GE | 13 | | |
| VCF1 | 11 | | |
| VCF1GE | 13 | | |
| VCF2 | 11 | | |
| VCF2GE | 13 | | |
| VCF3 | 11 | | |
| VCF3GE | 13 | | |
| VCF4 | 11 | | |
| VCF4GE | 13 | | |
| VCF5 | 11 | | |
| VCF6 | 11 | | |

Manual Motor Control Switches and Disconnects

Schneider Electric USA, Inc.
800 Federal Street
Andover, MA 01810 USA
888-778-2733
www.schneider-electric.us

Electrical equipment should be installed, operated, serviced, and maintained only by qualified personnel.

© 2013–2016 Schneider Electric. All Rights Reserved
Schneider Electric, Square D, TeSys, and Vario are trademarks owned by Schneider Electric Industries SAS or its affiliated companies. All other trademarks are the property of their respective owners.
9421CT0301R03/2016 Replaces 9421CT0301R07/2015, 08/2015