

RUL Series

RUL™ LED Rural Utility Luminaire

Product Description

The RUL™ LED Rural Utility luminaire delivers ultra-efficient LED lighting with a low total cost of ownership and a quick return on investment for end users requiring a 70-100W HPS or 100-175W Mercury Vapor replacement solution. By providing industry-leading efficacy of up to 114 lumens per watt and an industry-leading 10-year limited warranty, Cree is changing the assumptions associated with purchasing and maintaining utility and residential security lighting. While its lightweight design, tool-less entry, and easy installation make the RUL™ LED Rural Utility Luminaire an ideal solution for any contractor. Kitted options available.

Applications: Rural, residential, street lighting, agricultural, and general security lighting

Performance Summary

Efficacy: Up to 114 LPW

CRI: Minimum 70 CRI

CCT: 3000K (+/- 300K), 4000K (+/- 300K)

Limited Warranty*: 10 years on luminaire and photocell/7 years on arm mount/
5 years on reflector/refractor

* See <http://lighting.cree.com/warranty> for warranty terms

Accessories

Field-Installed	
Arm Mount RUL-ARM24 - 24.0" (610mm) curved raw aluminum arm mount - Includes zinc-plated steel hardware - Mounts to wood poles - Weight: 1.82 lbs. (0.8kg)	Long-Life Photocell RUL-PEC - Must be ordered with RUL luminaire - Weight: 0.28 lbs. (0.1kg) NEMA® Style Reflector/Refractor RUL-REF - Must be ordered with RUL luminaire - Weight: 2.20 lbs. (1.0kg)



RUL Luminaire w/ES-K1 Option shown (photocell, 10kV surge suppression protection, 7' cord, and arm not included with standard luminaire)

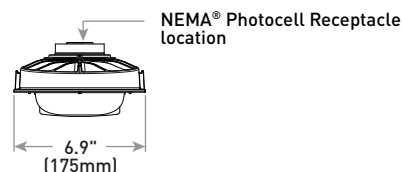
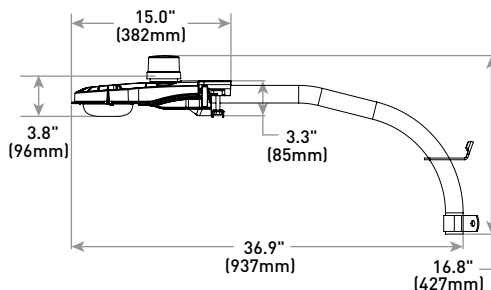

Weight*
3.75 lbs (1.7kg)

* RUL-ARM24/ES-K1 Option: add 1.82 lbs. (0.8kg)

Luminaire w/ES-K2 option shown on page 4

Ordering Information

Example: RULHT2MEC30K-12UFN

RUL	HT		C		12	UF	N		
Product	Mounting	Optic	Input Power Designator	CCT	Voltage	Color Options	Utility Label/Receptacle		Option
RUL	HT Horizontal Tenon	2ME Type II Medium 5ME Type V Medium	C 50W	30K 3000K 40K 4000K	12 120V	UF Grey Unfinished	N Utility Label and NEMA® Photocell Receptacle - Label per ANSI C136.15 - 3-pin receptacle per ANSI C136.10 - Photocell and shorting cap by others		ES 10kV Surge Suppression Protection CORD 7' Cord (Pre-Installed) ES-K1 Utility Kit - Includes: 10kV surge suppression protection, long-life photocell, 24" arm mount and 7' cord (pre-installed) ES-K2 Utility Kit - Includes: 10kV surge suppression protection, long-life photocell, 24" arm mount, NEMA® style reflector/refractor and 7' cord (pre-installed)



Rev. Date: V10 05/08/2017



Product Specifications

CONSTRUCTION & MATERIALS

- Die cast aluminum housing w/UV stabilized polymeric door
- Clear borosilicate glass refractor
- Compatible with ANSI C136.6 reflectors/refractors
- Tool-less entry
- Mounts on 1.25" IP, 1.66" (42mm) O.D. or 2" IP, 2.375" (60mm) O.D. horizontal tenon (minimum 3" [76mm] in length) and is adjustable +/- 5° in 2.5° increments to allow for fixture leveling
- Luminaire secured with two 3/8-16 x 2.0" mounting bolts
- Comes standard with Utility Label per ANSI C136.15 and 3-pin NEMA® Photocell Receptacle per ANSI C136.10
- ES-K1 packages the following items in a single box for convenience:
 - RUL™ utility luminaire w/10kV surge suppression protection
 - Long-life photocell
 - 7' (2.1m) 14/3 SEOW cord (pre-installed)
 - 24.0" (610mm) curved raw aluminum arm mount w/zinc-plated steel hardware for mounting to wood poles
- ES-K2 packages the following items in a single box for convenience:
 - RUL™ utility luminaire w/10kV surge suppression protection
 - Long-life photocell
 - 7' (2.1m) 14/3 SEOW cord (pre-installed)
 - 24.0" (610mm) curved raw aluminum arm mount w/zinc-plated steel hardware for mounting to wood poles
 - NEMA® style reflector/refractor
- **Weight:** See Weight chart on pages 1 and 4

ELECTRICAL SYSTEM

- **Input Voltage:** 120V, 60Hz
- **Power Factor:** > 0.9
- **Total Harmonic Distortion:** < 20%
- Integral 6kV surge suppression protection standard; 10kV optional w/ES, ES-K1 and ES-K2 options
- When code dictates fusing, a slow blow fuse or type C/D breaker should be used to address inrush current
- Electrolytic capacitor-free design provides high reliability
- **Operating Temperature Range:** -40°C - +25°C (-40°F - +77°F)

REGULATORY & VOLUNTARY QUALIFICATIONS

- cULus Listed
- Suitable for wet locations
- Luminaire only certified to ANSI C136.31-2001, 3G bridge and overpass vibration standards
- 6kV surge suppression protection tested in accordance with IEEE/ANSI C62.41.2 on standard luminaires
- 10kV surge suppression protection tested in accordance with IEEE/ANSI C62.41.2 on luminaires w/ES, ES-K1 and ES-K2 options
- Meets FCC Part 15, Subpart B, Class A standards for conducted and radiated emissions
- DLC qualified. Please refer to www.designlights.org/QPL for most current information
- RoHS compliant. Consult factory for additional details

Electrical Data*		
Input Power Designator	System Watts 120V	Total Current (A)
		120V
C	50	0.42

* Electrical data at 25°C (77°F). Actual wattage may differ by +/- 10% when operating at 120V +/- 10%

Recommended RUL Luminaire Lumen Maintenance Factors (LMF) ¹						
Ambient	Input Power Designator	Initial LMF	25K hr Projected ² LMF	50K hr Calculated ³ LMF	75K hr Calculated ³ LMF	100K hr Calculated ³ LMF
5°C (41°F)	C	1.04	0.97	0.92	0.87	0.83
10°C (50°F)	C	1.03	0.96	0.91	0.86	0.82
15°C (59°F)	C	1.02	0.95	0.90	0.85	0.81
20°C (68°F)	C	1.01	0.94	0.89	0.84	0.80
25°C (77°F)	C	1.00	0.93	0.88	0.84	0.79

¹Lumen maintenance values at 25°C (77°F) are calculated per TM-21 based on LM-80 data and in-situ luminaire testing

²In accordance with IESNA TM-21-11, Projected Values represent interpolated value based on time durations that are within six times (6X) the IESNA LM-80-08 total test duration (in hours) for the device under testing ((DUT) i.e. the packaged LED chip)

³In accordance with IESNA TM-21-11, Calculated Values represent time durations that exceed six times (6X) the IESNA LM-80-08 total test duration (in hours) for the device under testing ((DUT) i.e. the packaged LED chip)

Photometry

All published luminaire photometric testing performed to IESNA LM-79-08 standards by a NVLAP accredited laboratory. To obtain an IES file specific to your project consult: <http://lighting.cree.com/products/outdoor/street-and-roadway/rul-series>

2ME

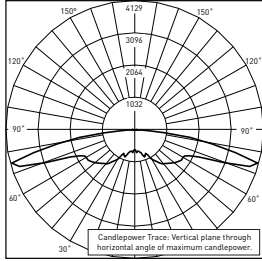

RESTL Test Report #: PL05401-001
RUL2MEC40K-12UFN**
Initial Delivered Lumens: 5,454

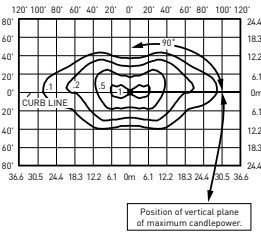

RUL2MEC40K-12UFN**
Mounting Height: 25' (7.6m) A.F.G.
Initial Delivered Lumens: 5,560
 Initial FC at grade

Type II Medium Distribution (also applies w/ES-K1 Option)				
Input Power Designator	3000K		4000K	
	Initial Delivered Lumens*	BUG Ratings** Per TM-15-11	Initial Delivered Lumens*	BUG Ratings** Per TM-15-11
C	5,215	B2 U2 G2	5,560	B2 U2 G2

* Initial delivered lumens at 25°C (77°F). Actual production yield may vary between -10 and +10% of initial delivered lumens
 ** For more information on the IES BUG (Backlight-Uplight-Glare) Rating visit: www.ies.org/PDF/Erratas/TM-15-11BUGRatingsAddendum.pdf. Valid with no tilt

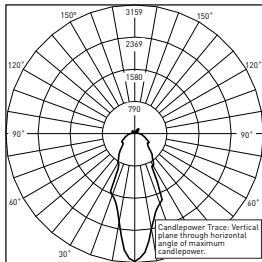

RESTL Test Report #: PL07270-001
RUL2MEC40K-12UFNES-K2**
Initial Delivered Lumens: 4,659

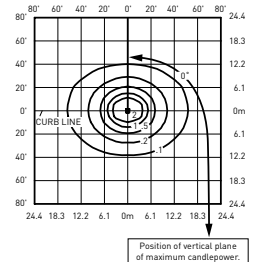

RUL2MEC40K-12UFNES-K2**
Mounting Height: 25' (7.6m) A.F.G.
Initial Delivered Lumens: 4,659
 Initial FC at grade

Type II Medium Distribution w/ES-K2 Option				
Input Power Designator	3000K		4000K	
	Initial Delivered Lumens*	BUG Ratings** Per TM-15-11	Initial Delivered Lumens*	BUG Ratings** Per TM-15-11
C	4,370	B2 U3 G1	4,659	B2 U4 G2

* Initial delivered lumens at 25°C (77°F). Actual production yield may vary between -10 and +10% of initial delivered lumens
 ** For more information on the IES BUG (Backlight-Uplight-Glare) Rating visit: www.ies.org/PDF/Erratas/TM-15-11BUGRatingsAddendum.pdf. Valid with no tilt

5ME

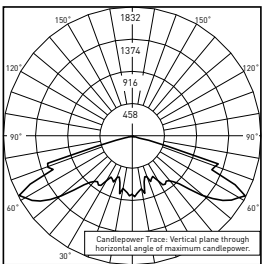

RESTL Test Report #: PL05399-001
RUL5MEC40K-12UFN**
Initial Delivered Lumens: 5,645

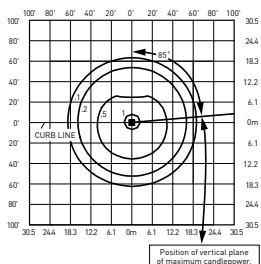

RUL5MEC40K-12UFN**
Mounting Height: 25' (7.6m) A.F.G.
Initial Delivered Lumens: 5,682
 Initial FC at grade

Type V Medium Distribution (also applies w/ES-K1 Option)				
Input Power Designator	3000K		4000K	
	Initial Delivered Lumens*	BUG Ratings** Per TM-15-11	Initial Delivered Lumens*	BUG Ratings** Per TM-15-11
C	5,365	B3 U2 G1	5,682	B3 U2 G1

* Initial delivered lumens at 25°C (77°F). Actual production yield may vary between -10 and +10% of initial delivered lumens
 ** For more information on the IES BUG (Backlight-Uplight-Glare) Rating visit: www.ies.org/PDF/Erratas/TM-15-11BugRatingsAddendum.pdf. Valid with no tilt

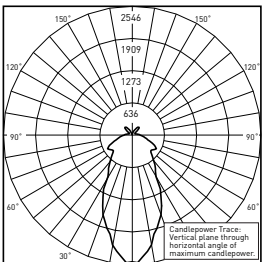

RESTL Test Report #:
RUL5MEC40K-12UFNES-K2**
Initial Delivered Lumens: 4,515

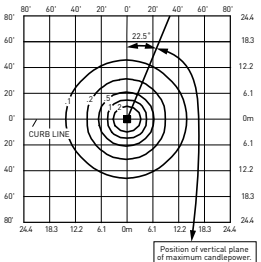





RUL5MEC40K-12UFNES-K2**
Mounting Height: 25' (7.6m) A.F.G.
Initial Delivered Lumens: 4,515
 Initial FC at grade

Type V Medium Distribution w/ES-K2 Option				
Input Power Designator	3000K		4000K	
	Initial Delivered Lumens*	BUG Ratings** Per TM-15-11	Initial Delivered Lumens*	BUG Ratings** Per TM-15-11
C	4,263	B2 U3 G2	4,515	B2 U4 G2

* Initial delivered lumens at 25°C (77°F). Actual production yield may vary between -10 and +10% of initial delivered lumens
 ** For more information on the IES BUG (Backlight-Uplight-Glare) Rating visit: www.ies.org/PDF/Erratas/TM-15-11BugRatingsAddendum.pdf. Valid with no tilt



Luminaire EPA

Horizontal Tenon Mount – Weight: 3.75 lbs. (1.7kg); RUL-ARM24/ES-K1 Option: add 1.82 lbs. (0.8kg); ES-K2 Option: add 3.07 lbs. (1.4kg); RUL-PEC; add 0.28 lbs. (0.1kg); RUL-REF; add 2.20 lbs. (1.0kg)					
Luminaire	Single	2 @ 90°	2 @ 180°	3 @ 90°	4 @ 90°
Tenon Configuration If used with Cree tenons, please add tenon EPA with luminaire EPA					
					
Standard Luminaire	0.28	0.46	0.56	0.74	0.92
Luminaire w/ES-K1 Option or RUL-PEC	0.70	1.76	1.40	2.46	3.52
Luminaire w/ES-K2 Option or RUL-PEC & RUL-REF	1.54	3.45	3.09	4.99	6.89
Luminaire w/RUL-REF	1.12	2.14	2.24	3.26	4.28

Tenon EPA

Part Number	EPA
RUL-ARM24	0.42

Tenons and Brackets*
Arm Mount RUL-ARM24 - 24.0" (610mm) curved raw aluminum arm mount - Includes zinc-plated steel hardware - Mounts to wood poles

* Refer to the [Bracket and Tenons spec sheet](#) for more details



RUL Luminaire shown with photocell and reflector/refractor; ES-K2 Option also includes 10kV surge suppression protection, 7' cord, and arm (not shown)

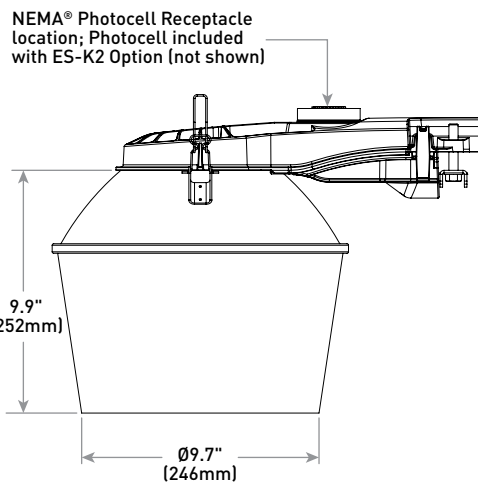

Luminaire w/ES-K2 Weight
6.82 lbs. (3.1kg)