

**Table of Contents**

Available Materials.....	G-2	WILEY Bundle Straps.....	G-25
Material Specifications.....	G-2	WILEY Twist Straps.....	G-26
Material Performance Guide.....	G-3	WILEY Cable Hangers.....	G-27
Cable Tie Catalog Schema.....	G-3	WILEY Coated P-Clips.....	G-29
Military Specification Information for UNIRAP™ Cable Ties.....	G-4	WILEY Cable Clips.....	G-30
UNIRAP™ Nylon Cable Ties - Engineering and Performance.....	G-5	WILEY Edge Clip with Cable Tie.....	G-32
UNIRAP™ Standard Nylon 6/6 Cable Tie`.....	G-6	Cable Tie Tools.....	G-33
UNIRAP™ Nylon 6/6 Identification Cable Ties.....	G-10	145PTAG 94V0 Rated Nylon Tag.....	G-33
UNIRAP™ Nylon 6/6 Push Mount Cable Ties.....	G-10		
Fir Tree Cable Tie Nylon 6/6.....	G-10		
UNIRAP™ Nylon 6/6 Releasable Cable Ties.....	G-11		
UNIRAP™ Nylon 6/6 Metal Detectable Cable Ties.....	G-11		
UNIRAP™ Nylon 6/6 Mounting Hole Cable Ties.....	G-12		
UNIRAP™ Heat Stabilized 6/6 Nylon Cable Ties.....	G-12		
UNIRAP™ Nylon 6/6 Standard Cable Tie Mounting Bases.....	G-13		
UNIRAP™ Nylon 6/6 Cable Hangers.....	G-14		
UNIRAP™ Stainless Steel Barb Cable Ties.....	G-15		
UNIRAP™ Nylon 6/6 Universal Grade Cable Ties.....	G-17		
UNIRAP™ Nylon 6/6 Mounting Hole Universal Grade Cable Ties.....	G-19		
UNIRAP™ Nylon 6/6 Universal Grade Mounting Bases.....	G-19		
UNIRAP™ Nylon 6/6 Cable Tie Variety Canister.....	G-20		
UNIRAP™ Nylon 12 Cable Ties.....	G-20		
VELCRO® Hook and Loop Straps.....	G-21		
TEFZEL® Fluoropolymer Ties.....	G-21		
UNIRAP™ Stainless Steel Ties; Grade 304; Uncoated.....	G-22		
UNIRAP™ Stainless Steel Ties; Grade 304; Partially Coated.....	G-23		
UNIRAP™ Stainless Steel Ties; Grade 304; Fully Coated.....	G-24		

**Most frequently ordered catalog numbers are highlighted in BLUE**

## Material Information; Available Materials; Material Specifications

### Available Materials

#### Nylon 6/6 — General Purpose

General purpose nylon 6/6 features light weight, high strength and a wide temperature range. It is halogen free so it does not release dangerous gases, such as chlorine, bromine, fluorine and iodine when burned. Nylon 6/6 is hygroscopic, and therefore, absorbs or releases moisture depending on its environment. Thus, the moisture level of the material will affect tensile strength, stiffness and elongation of the product.

#### Nylon 6/6 — Heat Stabilized

With similar properties and benefits as nylon 6/6, products manufactured with heat stabilized nylon 6/6 material have a chemical stabilizer added for higher continuous temperature applications.

#### Nylon 6/6 — UV Stabilized

Chemical inhibitors are used to give nylon 6/6 material added properties to fight against premature aging of products due to the effects of ultraviolet rays.

#### Nylon 6/6 — UV Stabilized (2% Carbon Military Specification)

The physical properties of this material include carbon, which acts as a UV stabilizer, prolonging the life of the product under ultraviolet conditions. It also allows cable ties to meet the particular military specification for cable ties.

#### Nylon 6/6 — V0 Flame Retardant

This material meets UL 94V-0 flammability requirements. Flame retardant additives generally reduce tensile strength when compared to general-purpose nylon 6/6, but this resin has been formulated to minimize such effects.

#### Nylon 6/6 — Metal Detectable

Metal content blended through cable tie. Meets US FDA food contact material compliance. Used to help prevent possible contamination that may result in recalls. Often used in food processing, beverage, pharmaceutical and cosmetic industries.

#### Nylon 6/6 — High Impact

Impact modifiers are added to increase flexibility. High impact nylon 6/6 has stable tensile strength due to its reduced influence from moisture. It is excellent for high vibration applications, as within the aircraft and automobile industries and performs better than nylon 6/6 against ultraviolet rays. Good for outdoor use.

#### Polypropylene

Polypropylene is used in environments where chemical effects on nylon are a concern. It is not affected by inorganic acids (hydrochloric), polyhydric alcohols (ethyleneglycol), neutral salts (sodium chloride) and basic salts (sodium bicarbonate). Polypropylene also resists a number of other chemicals with good results, although it has lower tensile strength than nylon 6/6 (about half). Polypropylene has good UV resistance.

#### Nylon 12 — UV Stabilized

Nylon 12 is resistant to chemicals and salts. Ideal for solar applications. Weather resistant grade, produced by the addition of stabilizers to the nylon resin.

#### Stainless Steel

Stainless Steel is used where corrosion, vibration, weathering, and temperature extremes are a concern. May be used for virtually any indoor, outdoor, or underground application. Available in both 304 and 316 Stainless Steel. Also available partially or fully coated with polyester.

#### TEFZEL® Fluoropolymer

TEFZEL® Fluoropolymer ties feature a low smoke density with excellent flammability rating (UL 94V-0) and tolerates extreme high and low temperatures. TEFZEL® comes in an aqua blue color with an operating temperature of Min. -112°F (-80°C), Max. 338°F (170°C). TEFZEL® is a Registered trademark of E.I. du Pont de Nemours and Company.

### Material Specifications

Material	Continuous* Operating Temperature Max. Min.	Tensile Strength at 73° F Dry as Molded ASTM D-638 (PSI)	UL Flame Rating	Oxygen Index %	Gamma Radiation Resistance	UV Resistance	Military, Federal, ASTM, and FDA Specifications
Nylon 6/6 — General Purpose (CT)	185° F — -40° F 85° C — -40° C	12,000	94V-2	28	1 x 105 Rads	Poor	ASTM D-4066PA0111 FDA CFR177.1500
Nylon 6/6 — Heat Stabilized (CTHS)	220° F — -40° F 105° C — -40° C	12,000	94V-2	26	1 x 105 Rads	Poor	ASTM D-4066PA0121
Nylon 6/6 — UV Stabilized (O)	185° F — -40° F 85° C — -40° C	12,000	94V-2	26	1 x 105 Rads	Good	ASTM D4066PA0191
Nylon 6/6 — 2% Carbon UV Stabilized (OO)	220° F — -40° F 105° C — -40° C	12,000	94V-2	26	1 x 105 Rads	Good	ASTM D-4066PA0181 MS3367/8
Nylon 6/6 — Flame Retardant (CTV)	185° F — -40° F 85° C — -40° C	10,800	94V-0	34	1 x 105 Rads	Poor	ASTM D-4066PA0110
Nylon 6/6 — High Impact	185° F — -40° F 85° C — -40° C	8,800	94-HB	19	1 x 105 Rads	Good	ASTM D-4066PA0150
Polypropylene — Chemical Resistant (CTPP)	185° F — -40° F 85° C — -40° C	3,400	94-HB	N/A	1 x 105 Rads	Good	ASTM D-4101PP0320 FDA CFR177.1520
Nylon 12 — UV Stabilized	176° F — -40° F 80° C — -40° C	5,800	94-HB	N/A	9 x 106 Rads	Good	ASTM D-4066PA411

\* Elevated temperatures, over time, will affect materials' properties such as tensile strength, stiffness, elongation and appearance.

BURNDY® recommends the evaluation of cable ties in the actual application to determine the suitability of the tie for that application.

# Material Performance Guide, Cable Tie Catalog Schema

## Material Performance Guide

Selection	Nylon 6/6 General Purpose	Nylon 6/6 Heat Stab.	Nylon 6/6 UV Stab.	Nylon 6/6 2% Carbon UV Stab.	Nylon 6/6 Flame Ret. V0	Nylon 6/6 High Impact	Polypropylene	Nylon 12 UV Stab.
Tensile Strength	8	8	8	9	7	8	2	4
High Temp.	2	3	2	2	2	2	2	1
Flammability	5	5	5	5	10	2	2	2
UV Resistance	1	1	5	8	1	2	5	3
Radiation	3	3	3	3	3	3	6	3
Chemical	6	6	6	6	6	6	8	8
— Hydrocarbons	8	8	8	8	8	8	6	8
— Chlorinated	6	6	6	6	6	6	3	8
— Hydrocarbons	2	2	2	2	2	2	8	5
— Acids-Bases	6	6	6	6	6	6	8	6
— Salts	3	3	3	3	3	3	10	8
Relative Cost	Low	Low	Med.	Med.	Med.	Med.	Med.	Med.

1 = Least Recommended 10 = Most Recommended

The following chart is meant to help you understand BURNDY's cable tie catalog numbering system. Not every cable tie is available in every listed option. See below Catalog Numbering System Charts or contact BURNDY® Customer Service for more information.

Gray bars contain catalog number examples.

Type	Tensile	Bundle Dia.	Feature	Package	Color
<b>CT</b>	<b>50</b>	<b>175</b>		<b>C</b>	
CT = Nylon 6/6 Standard	18 = 18 lbs. 30 = 30 lbs. 40 = 40 lbs.	075 = 3/4" 087 = 7/8" 100 = 1"	CPM = Center Push Mount DL = Double Loop EPR = Extended Pawl Releasable ID = Single Head ID ID2 = Double Head ID ID3 = Triple Head ID FL = ID Flag MH4 = Mounting Hole #4 MH6 = Mounting Hole #6 MH8 = Mounting Hole #8 MH10 = Mounting Hole #10 MH14 = Mounting Hole #14 PM = Push Mount Tie PML = Push Mount Tie w/Louvers PMW = Push Mount Tie w/Wing R = Releasable Tie LD = Ladder LP = Low Profile Tie PS = Positive Stop SSB = Stainless Steel Barb FC304 = Fully Coated 304 FC316 = Fully Coated 316 PC304 = Partially Coated 304 PC316 = Partially Coated 316 SSH = Stainless Steel Hook	V = 5 X = 10 Q = 25 L = 50 C = 100 B = 250 D = 500 M = 1000	0 = UV Black <sup>1</sup> 00 = UV Black <sup>2</sup> 02 = Red 1 = Brown 2 = Red 3 = Orange 4 = Yellow 5 = Green 6 = Blue 7 = Purple 8 = Gray 9 = Neon Green 10 = White 11 = Telco Gray 12 = Pink 20 = Black  Blank = Natural
CTAS = Aerial Support	50 = 50 lbs. 100 = 100 lbs. 110 = 110 lbs.	125 = 1-1/4" 137 = 1-3/8" 150 = 1-1/2"			
CTHS = Nylon 6/6 Heat Stabilized	120 = 120 lbs. 175 = 175 lbs. 225 = 225 lbs.	175 = 1-3/4" 200 = 2" 225 = 2-1/4"			
CTV = Nylon 6/6 Flame Retardant UL94V-0	250 = 250 lbs. 450 = 450 lbs. 500 = 500 lbs.	250 = 2-1/2" 300 = 3" 325 = 3-1/4"			
CTPP = Polypropylene	675 = 675 lbs. 700 = 700 lbs. 800 = 800 lbs.	350 = 3-1/2" 400 = 4" 425 = 4-1/4"			
CTSS = Stainless Steel	900 = 900 lbs.	500 = 5" 600 = 6" 700 = 7" 750 = 7-1/2"			
CTNT = Nylon 12		800 = 8" 900 = 9" 1000 = 10" 1100 = 11" 1200 = 12" 1300 = 13" 1400 = 14"			
CT-UG = Nylon 6/6 Universal Grade					
CMDT = Nylon 6/6 Metal Detectable					
CTZ = TEFZEL <sup>1</sup>					

<sup>1</sup>Material: Nylon 6/6 — UV Stabilized

<sup>2</sup>Material: Nylon 6/6 — 2% Carbon UV Stabilized (Mil. Spec.)

Type	Bundle Diameter	Adhesive/Mounting Type	Figure #	Package	Color
<b>CTB</b>	<b>100</b>	<b>RA</b>		<b>C</b>	<b>0</b>
CTB = Cable Tie Base	075 = 3/4"	RA = Rubber Adhesive	#1	L = 50	0 = UV Black
CTBR = Cable Tie Base Rectangular	125 = 1-1/4" 150 = 1-1/2"	AA = Acrylic Adhesive S = Screw Mounted	#2 #3	C = 100 D = 500 M = 1000	Blank = Natural
CTBRWR = Cable Tie Base Weather Resistant					

## Cable Ties Military Specification Information

### Military Specification Information on UNIRAP™ Cable Ties

The BURNDY® UNIRAP™ Cable Ties shown below meet the requirements of SAE AS23190A (formerly MIL-S-23190) in accordance with specification MS3367, MS3368, and QPL-23190.

Mil Spec	Distributor Pack Catalog Number	Bulk Pack Catalog Number	Color
MS3367-1-0	CT50175C00	CT50175M00	UV Black <sup>2</sup>
MS3367-1-0	CT50175C0	CT50175M0	UV Black <sup>1</sup>
MS3367-1-1	CT50175C1	—	Brown
MS3367-1-2	CT50175C2	CT50175M02	Red
MS3367-1-3	CT50175C3	—	Orange
MS3367-1-4	CT50175C4	—	Yellow
MS3367-1-5	CT50175C5	—	Green
MS3367-1-6	CT50175C6	—	Blue
MS3367-1-7	CT50175C7	—	Purple
MS3367-1-8	CT50175C8	—	Gray
MS3367-1-9	CT50175C	CT50175M	Natural
MS3367-2-0	CT50400C00	—	UV Black <sup>2</sup>
MS3367-2-0	CT50400C0	—	UV Black <sup>1</sup>
MS3367-2-2	CT50400C2	CT50400M02	Red
MS3367-2-3	CT50400C3	—	Orange
MS3367-2-9	CT50400C	—	Natural
MS3367-3-0	CT120400L00	—	UV Black <sup>2</sup>
MS3367-3-0	CT120400L0	—	UV Black <sup>1</sup>
MS3367-3-9	CT120400L	—	Natural
MS3367-4-0	CT18075C00	CT18075M00	UV Black <sup>2</sup>
MS3367-4-0	CT18075C0	CT18075M0	UV Black <sup>1</sup>
MS3367-4-9	CT18075C	CT18075M	Natural
MS3367-5-0	CT30125C00	CT30125M00	UV Black <sup>2</sup>
MS3367-5-0	CT30125C0	CT30125M0	UV Black <sup>1</sup>
MS3367-5-9	CT30125C	CT30125M	Natural
MS3367-7-0	CT50300C00	—	UV Black <sup>2</sup>
MS3367-7-0	CT50300C0	—	UV Black <sup>1</sup>
MS3367-7-2	CT50300C2	—	Red
MS3367-7-9	CT50300C	—	Natural
MS3367-13-0	CT175900Q00	—	UV Black <sup>2</sup>
MS3367-13-9	CT1751100Q	—	Natural

<sup>1</sup>Material: Nylon 6/6 UV Stabilized

<sup>2</sup>Material: Nylon 6/6 2% UV Stabilized - Mil. Spec.

# UNIRAP™ Nylon Cable Ties — Engineering and Performance

## UNIRAP™ Nylon Cable Ties

UNIRAP™ cable ties are fabricated of one piece Nylon with no metal parts. The straps are tough, resilient, lightweight and abrasion resistant. They offer high tensile strength and are chemically resistive to solvents, alkalies, oils, grease and diluted acids. Self-locking, they secure without twisting or leaving sharp projections.

Compact heads and pre-bent tips facilitate cable bundling in a minimum of time and space. UNIRAP™ cable ties are designed for both field and production line use and may be installed easily by hand.



BURNDY® cable ties consist of three components: strap, head, and tail. These components are specifically designed to function together to make BURNDY® UNIRAP™ cable ties superior in quality and performance. Shelf life of 5 years, when stored in original packaging.

### Component

### Precision Engineering

### Enhanced Performance

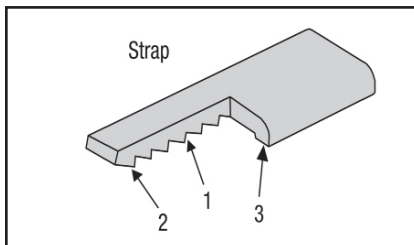

1. Includes load bearing **serrations**.
2. Features **flats** between the serrations.
3. Features the **double outer rail system**.

1. Serrations provide complete adjustability within the fastening range.
2. Flats reduce stress concentrations and help make the tie stronger.
3. Smooth rails promote low drag, as well as minimize chafing.

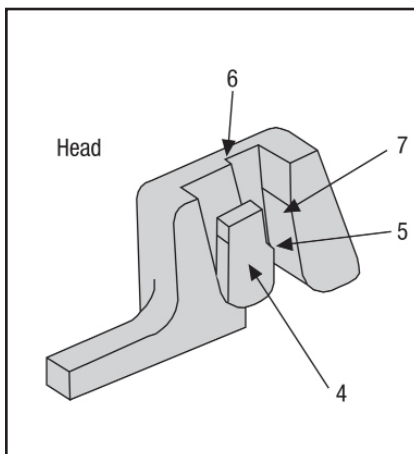

4. The **pawl** is integrally formed with the head.
5. The **pawl** is stepped in order to wedge against the serrations in the strap to form the lock.
6. The **shoulders**, or the sides of the head, guide the strap and prevent it from disengaging from the pawl during loaded conditions.
7. The **back** supports the strap during the wedging of the lock formation.

4. The locking unit will not disengage. It also promotes low insertion with high pull out force for very easy installation.
5. The tie's ultimate strength achieves optimum levels.
6. Promotes cable tie strength, endurance and longevity.
7. Ensure optimum locking capability.

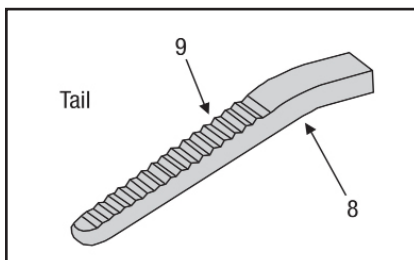

8. Features a **bent tip**.
9. Includes a **ribbed grip**.

8. Easy pick-up for installers, which leads to fast assembly.
9. Allows for easy, no-slip grip.

# Cable Ties Nylon 6/6 Standard

## UNIRAP™ Standard Cable Ties Type CT

General purpose nylon 6/6 features light weight, high strength and a wide temperature range. It is halogen free so it does not release dangerous gases, such as chlorine, bromine, fluorine, or iodine when burned. Nylon 6/6 is hygroscopic, and therefore absorbs or releases moisture depending on its environment. Thus, the moisture level of the material will affect tensile strength, stiffness, and elongation of the product.

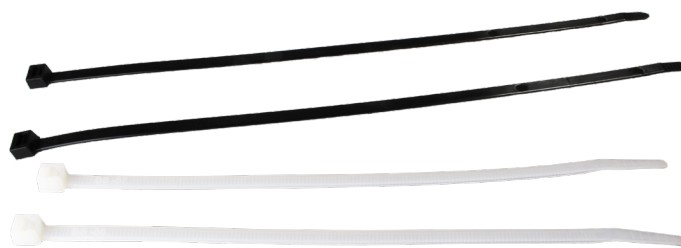

UV Black / UV Black (Mil. Spec.) are 2% Carbon UV Stabilized.



UL62275  
Type 2 & 21

Std Pkg Catalog Number	Color	Max. Bundle Dia. In. [mm]	Min. Tensile Strength (lb)	Length		Width		Bulk Pkg Catalog Number	UL Type	Plenum Rated
				in [mm]	in [mm]	in [mm]	in [mm]			
<b>Nylon UNIRAP - 18 Lb. Tensile Strength</b>										
CT18075C	Natural (Mil. Spec.)	0.75 [19.1]	18	4.10 [104]	0.10 [2.5]	CT18075M		UL 62275, Type 2 & 21	Y	
CT18075C0	UV Black (Mil. Spec.)					CT18075M0				
CT18075C00	UV Black (Mil. Spec.)					CT18075M00				
CT18125C	Natural	1.25 [31.8]		6.10 [155]		CT18125M				
CT18125C0	UV Black					CT18125M0				
CT18125C3	Orange					-				
CT18125C4	Yellow	2.00 [50.8]		8.10 [206]		CT18200M				
CT18200C	Natural					-				
CT18200C1	Brown					-				
CT18200C2	Red					-				
CT18200C5	Green					-				
CT18200C6	Blue					-				
CT18200C0	UV Black	CT18200M0								
<b>Nylon UNIRAP - 30 Lb. Tensile Strength</b>										
CT30125C	Natural (Mil. Spec.)	1.25 [31.8]	30	5.75 [146]	0.14 [3.6]	CT30125M		UL 62275, Type 2 & 21	Y	
CT18125C3	Orange					-				
CT18125C4	Yellow					-				
CT30125C0	UV Black (Mil. Spec.)					CT30125M0				
CT30125C00	UV Black (Mil. Spec.)					CT30125M00				

# Cable Ties Nylon 6/6 Standard

## UNIRAP™ Standard Cable Ties Type CT (Continued)



UL62275  
Type 2 & 21



Std Pkg Catalog Number	Color	Max. Bundle Dia. In. [mm]	Min. Tensile Strength (lb)	Length		Width		Bulk Pkg Catalog Number	UL Type	Plenum Rated
				in [mm]	in [mm]	in [mm]	in [mm]			
<b>Nylon UNIRAP - 40 Lb. Tensile Strength</b>										
CT40200C	Natural	2.00 [50.8]	40	8.65 [220]	0.14 [3.6]	CT40200M		UL 62275, Type 2 & 21	Y	
CT40200C0	UV Black					CT40200M0				
CT40200C00	UV Black					CT40200M00				
CT40300C	Natural	3.00 [76.2]		11.10 [282]	0.18 [4.6]	CT40300M				
CT40300C0	UV Black					—				
CT40300C00	UV Black					—				
—	Natural	4.00 [101.6]		14.60 [371]	0.18 [4.6]	CT40400M				
CT40400C0	UV Black					—				
CT40400C00	UV Black					CT40400M00				
<b>Nylon UNIRAP - 50 Lb. Tensile Strength</b>										
CT50175C	Natural (Mil. Spec.)	1.75 [44.5]	50	7.60 [193]	0.18 [4.6]	CT50175M		UL 62275, Type 2 & 21	Y	
CT50175C0	UV Black (Mil. Spec.)					CT50175M0				
CT50175C1	Brown (Mil. Spec.)					CT50175M02				
CT50175C2	Red (Mil. Spec.)					—				
CT50175C3	Orange (Mil. Spec.)					—				
CT50175C4	Yellow (Mil. Spec.)					—				
CT50175C5	Green (Mil. Spec.)					—				
CT50175C6	Blue (Mil. Spec.)					—				
CT50175C7	Purple (Mil. Spec.)					—				
CT50175C8	Gray (Mil. Spec.)					—				
CT50175C00	UV Black (Mil. Spec.)					CT50175M00				

# Cable Ties Nylon 6/6 Standard

## UNIRAP™ Standard Cable Ties Type CT (Continued)



UL62275  
Type 2 & 21



UR1565



Std Pkg Catalog Number	Color	Max. Bundle Dia. In. [mm]	Min. Tensile Strength (lb)	Length		Bulk Pkg Catalog Number	UL Type	Plenum Rated	
				in [mm]	Width in [mm]				
CT50300C	Natural (Mil. Spec.)	3.00 [76.2]	50	11.10 [282]	0.18 [4.6]	—	UL 62275, Type 2 & 21	Y	
CT50300C0	UV Black (Mil. Spec.)					—			
CT50300C2	Red (Mil. Spec.)					—			
CT50300C00	UV Black (Mil. Spec.)					—			
CT50400C	Natural (Mil. Spec.)	4.00 [101.6]		14.60 [371]	0.18 [4.6]	—			CT50400M02
CT50400C0	UV Black (Mil. Spec.)					—			
CT50400C2	Red (Mil. Spec.)					—			
CT50400C3	Orange (Mil. Spec.)					—			
CT50400C00	UV Black (Mil. Spec.)					—			
<b>Nylon UNIRAP - 120 Lb. Tensile Strength</b>									
CT120400L	Natural (Mil. Spec.)	4.00 [101.6]	120	15.00 [381]	0.30 [7.6]	—	UL 62275, Type 2 & 21	Y	
CT120400L0	UV Black (Mil. Spec.)					—			
CT120400L00	UV Black (Mil. Spec.)					—			
CT120800L	Natural	8.00 [203.2]		28.51 [724]	0.30 [7.6]	—		—	N
CT120800L00	UV Black					—			—



# Cable Ties Nylon 6/6 Standard

## UNIRAP™ Standard Cable Ties Type CT (Continued)



Std Pkg Catalog Number	Color	Max. Bundle Dia. In. [mm]	Min. Tensile Strength (lb)	Length	Width	Installation Tooling		Bulk Pkg Catalog Number	UL Type	Plenum Rated
				in [mm]	in [mm]	Tool	Tool Setting (if applicable)			
<b>Nylon UNIRAP - 175 Lb. Tensile Strength</b>										
CT175500Q	Natural	5.50 [139.7]	175	18.10 [460]	0.34 [8.6]	MK9	Heavy	—	UL 62275, Type 2 & 21 UL 62275, Type 2 & 21	Y
CT175500Q0	UV Black			32.67 [830]	0.35 [8.9]			—		N
CT175800Q0	UV Black	8.75 [222.0]	175	36.50 [927]	0.34 [8.6]	MK9	Heavy	—		Y
CT175900Q	Natural							—		N
CT175900Q00	UV Black (Mil. Spec.)							—		Y
CT1751100Q	Natural (Mil. Spec.)	11.00 [279.4]	175	48.50 [1232]	0.34 [8.6]	MK9	Heavy	—		N
CT1751500Q	Natural	15.00 [381.0]						—	N	
<b>Nylon UNIRAP - 250 Lb. Tensile Strength</b>										
CT250800Q	Natural	8.00 [203.2]	250	28.74 [730]	0.35 [8.9]	MK9	Heavy	—	UR 1565	N
CT250800Q0	UV Black			28.50 [724]				—		
CT2501000Q	Natural	10.00 [254.0]		34.64 [880]	0.50 [12.7]			—		
CT2501200Q	Natural	12.00 [305.0]		40.00 [1016]	0.50 [12.7]			—		
CT2501200Q0	UV Black							—		

## Cable Ties Nylon 6/6 Identification and Push Mount, Fir Tree

### UNIRAP™ Identification Cable Ties Type CT-ID

Identification cable ties are used in both bundling and identifying the wire groups at the same time. Same material, features and benefits as the Nylon 6/6 Standard Cable Ties.

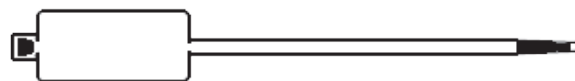

Fig. #1

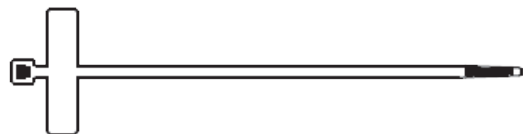

Fig. #2

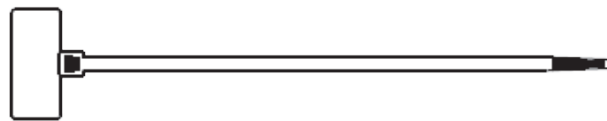
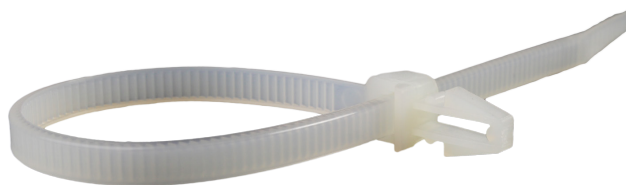

Fig. #3

Std Pkg Catalog Number	Material	Color	Fig.	Marking Pad Size Inches	Max Bundle Diameter Inches [mm]	Min Tensile Strength (lbs)	Length Inches [mm]	Width Inches [mm]
CT18075FLC	Nylon 6/6	Natural	3	.36 X .81	0.75 [19]	18	4.10 [104]	0.10 [2.5]
CT18075IDC			2	.33 X 1.00	0.75 [19]	18	4.01 [102]	0.10 [2.5]
CT18200IDC			2	.33 X 1.00	2.09 [53]	18	7.72 [196]	0.10 [2.5]
CT50175IDC			1	.51 X 1.09	1.75 [44]	50	7.48 [190]	0.18 [4.6]
CT50250IDC			1	.51 X 1.09	2.95 [75]	50	10.60 [269]	0.19 [4.8]

### UNIRAP™ Push Mount Cable Ties Type CT-PM

Push Mount Cable Ties attach cable bundle to other surface through a pre-drilled hole. One piece design provides extra stability, reliability, and consistent performance. Same material and features as the Nylon 6/6 Standard Cable Ties.



Std Pkg Catalog Number	Material	Color	Max Bundle Diameter In. [mm]	Min Tensile Strength (lb)	Length Inches [mm]	Width Inches [mm]
CT50175PMC	Nylon 6/6	Natural	1.75 [44.5]	50	8.50 [216]	0.18 [4.6]
CT50175PMC0		UV Black				

### Fir Tree Cable Tie Type CTFT

Fir Tree Mount Cable Ties provide low insertion pressure while providing high removal resistance for a solid fit. The fir tree allows for pre-installation assistance while mounted and then installed with ease. Provides protection in high vibration areas and applications.



Catalog Number	Material	Color	Max Bundle Diameter In. [mm]	Min Tensile Strength (lb)	Length Inches [mm]	Width Inches [mm]
CTFT50200C0	Nylon 6/6	UV Black	2.00" [50]	50	8.27 [210]	.19 [5]

# Cable Ties Nylon 6/6 Releasable Cable Ties; Metal Detectable Ties

## UNIRAP™ Releasable Cable Ties Type CT-R

Perfect for prototype construction, releasable ties are ideal for temporary installations. Releasable ties are good for applications where service requires adding or subtracting wires from an existing bundle.

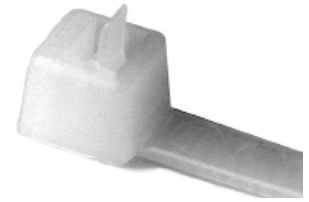
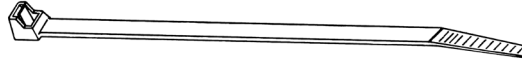

Std Pkg Catalog Number	Material	Color	Max Bundle Diameter In. [mm]	Min Tensile Strength (lbs)	Length Inches [mm]	Width Inches [mm]
CT50175RC	Nylon 6/6	Natural	2.13 [54.1]	50	8.00 [198]	0.19 [4]
CT50175RC0		UV Black				
CT50137RC		Natural	1.40 [35.6]	50	6.00 [151]	
CT50400RC		Natural	4.00 [101.6]	50	15.20 [387]	
CT50400RC0		UV Black				
CT250200RQ		Natural	2.52 [64.0]	250	9.50 [241]	
CT250200RQ0		UV Black				
CT250500RQ		Natural	5.00 [127.0]	250	20.00 [509]	
CT250500RQ0		UV Black				
CT250600RQ		Natural	6.00 [152.4]	250	24.30 [618]	
CT250600RQ0		UV Black				
CT250800RQ		Natural	8.00 [203.2]	250	28.50 [724]	
CT250800RQ0		UV Black				
CT2501000RQ		Natural	9.76 [248.0]	250	32.60 [830]	

## UNIRAP™ Metal Detectable Type CMDT

These ties are perfect for use in consumable products such as food processing applications, beverage, pharmaceutical, and cosmetic industries. The metal detectable ties are an excellent choice and are US FDA food contact material compliant\*.

\*Metal detectable material complies with the compositional requirements of US FDA regulations for Direct Food Contact; 21 CFR 177.1500 and 21 CFR 184.1375.

Customer is responsible for ensuring the setting on metal detectable machines is adjusted and monitored



for wet or dry products or environments, ferrous and non ferrous metals, type of food/products, packaging material speed, and orientation of scanned product.

Catalog Number (100 per package)	Material	Color	Max Bundle Diameter In. [mm]	Min Tensile Strength (lbs)	Length Inches [mm]	Width Inches
CMDT18075C5	Nylon 6/6 Metal content blended throughout	Teal	.87 [22.2]	18	4.12 [104.7]	.09
CMDT40225C5			2.47 [60.3]	40	8.87 [225.4]	.14
CMDT50175C5			1.87 [47.6]	50	7.56 [192.0]	.18
CMDT50300C5			3.00 [77.7]	50	11.25 [285.7]	.18
CMDT50400C5			4.00 [101.6]	50	14.25 [361.9]	.18
CMDT120400C5			4.00 [101.6]	120	15.09 [383.3]	.30

# Cable Ties Nylon 6/6 Mounting Hole / Heat Stabilized

## UNIRAP™ Mounting Hole Cable Ties Type CT-MH

Bundling and mounting, one easy installation. Ideal for use where bundle needs to be secured, such as control panels and ceilings. Can be bundled before or after mounting.

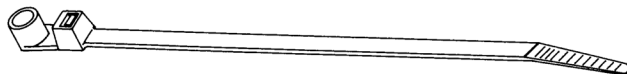

Std Pkg Catalog Number	Color	Screw Size	Max Bundle Diameter In. [mm]	Min Tensile Strength (lbs)	Length Inches [mm]	Width Inches [mm]	Bulk Catalog Number
CT18075MH4C	Natural	#4	0.75 [19.1]	18	3.93 [100]	0.10 [3.0]	CT18075MH4M
CT30125MH8C	Natural	#8	1.25 [31.8]	30	6.80 [173]	0.14 [4.0]	CT30125MH8M
CT30125MH8M0*	UV Black						—
CT50175MH10C	Natural	#10	1.75 [44.5]	50	8.10 [206]	0.18 [5.0]	CT50175MH10M
CT50175MH10C0	UV Black						CT50175MH10M0
CT50400MH10C	Natural	#10	4.00 [101.6]	50	15.10 [384]	0.18 [5.0]	—
CT50400MH10C0	UV Black						CT50400MH10M0
CT120400MH14L	Natural	1/4"	4.00 [101.6]	120	15.70 [399]	0.30 [8.0]	—
—	UV Black						CT120400MH14D0

\*Only available in Bulk Package of 1000 pieces.

## UNIRAP™ Heat Stabilized Cable Ties Type CTHS

With similar properties and benefits as nylon 6/6, product manufactured with heat stabilized nylon 6/6 material have a chemical stabilizer added for higher continuous temperature applications. Range up to 225° F.

### Features & Benefits

- Good fatigue resistance
- Resistant to chemicals
- Higher temperature range
- Meets the requirements of UL94V-2 flammability rating

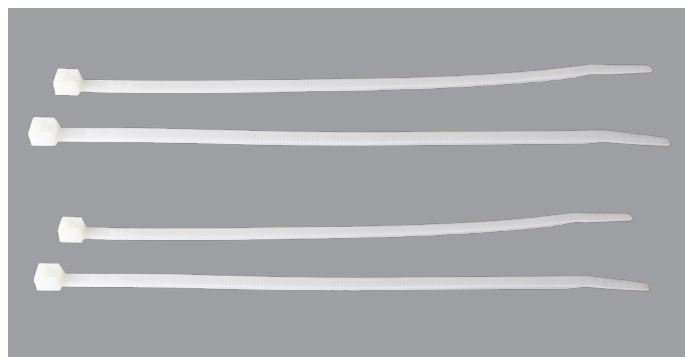

Catalog Number	Material	Color	Max Bundle Diameter In. [mm]	Min Tensile Strength (lbs)	Length Inches [mm]	Width Inches [mm]
CTHS18075M	Nylon 6/6 Heat Stabilized	Natural	0.75 [19.1]	18	4.10 [104]	0.10 [2.5]
CTHS40125M			1.25 [31.8]	40	5.75 [146]	0.14 [3.6]
CTHS50300M			3.00 [76.2]	50	11.10 [282]	0.18 [4.6]
CTHS50400M			4.00 [101.6]	50	14.60 [371]	
CTHS50700M			1.88 [47.8]	50	7.60 [193]	
CTHS120400M			4.00 [101.6]	120	15.00 [381]	0.30 [7.6]

## Nylon 6/6 Standard Cable Tie Mounting Bases

### UNIRAP™ Standard Cable Tie Mounting Bases Type CTB

BURNDY® offers a wide variety of mounting bases suited for many applications. Mounting bases are used in conjunction with cable ties to stabilize and secure wire bundles, both indoors and outdoors. Mounting bases can be secured to a surface using rubber adhesive, acrylic adhesive, or also can be screw mounted.

The Rubber Adhesive has an operating temperature range from 14°F/-10°C to 140°F/60°C; Acrylic Adhesive has a temperature range of 14°F/-10°C to 176°F/80°C. When using the screw mounting option ONLY (not using any adhesive to secure the base) the product has a temperature range of -40°F/-40°C to 185°F/85°C.

These mounting bases are available to accommodate CT18 through CT50 series cable ties. Insertion of ties can be made from all sides. Each mount may be secured with screws, adhesive backing, or both, for ease of application and stability. For applications where higher temperatures, certain chemicals, or UV radiation are a concern and an adhesive is the preferred method for securing, the acrylic adhesive mounting bases are recommended.



Fig. #1

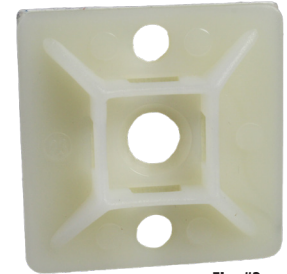

Fig. #2

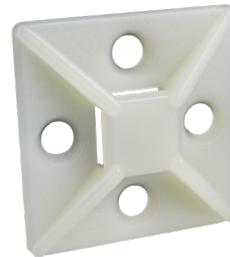

Fig. #3

Std Pkg Catalog Number	Mounting Method	Figure #	Color	Min Tensile Strength (lbs)	Max Tie Slot Width [mm]	Width Inches [mm]	Length Inches [mm]	Bulk Catalog Number
CTB075AAF1C	Acrylic Adhesive or #6 or #8 Screw	1	Natural	11	.17 [4.2]	0.75 [19]	0.75 [19]	CTB075AAF1M
CTB075AAF1C0	Acrylic Adhesive or #6 or #8 Screw	1	UV Black	11	.17 [4.2]	0.75 [19]	0.75 [19]	—
CTB075RAF1C	Rubber Adhesive or #6 or #8 Screw	1	Natural	11	.17 [4.2]	0.75 [19]	0.75 [19]	CTB075RAF1M
CTB075RAF1C0	Rubber Adhesive or #6 or #8 Screw	1	UV Black	11	.17 [4.2]	0.75 [19]	0.75 [19]	—
CTB075SF1C	#6 or #8 Screw Only	1	Natural	11	.17 [4.2]	0.75 [19]	0.75 [19]	CTB075SF1M
CTB100AAF2C	Acrylic Adhesive or #10 Screw	2	Natural	36	0.22 [5.5]	1.12 [28.4]	1.12 [28.4]	CTB100AAF2D
CTB100AAF2C0	Acrylic Adhesive or #10 Screw	2	UV Black	36	0.22 [5.5]	1.12 [28.4]	1.12 [28.4]	—
CTB100RAF2L	Rubber Adhesive or #10 Screw	2	Natural	36	0.22 [5.5]	1.12 [28.4]	1.12 [28.4]	CTB125RA4C
CTB100RAF2C0	Rubber Adhesive or #10 Screw	2	UV Black	36	0.22 [5.5]	1.12 [28.4]	1.12 [28.4]	—
CTB100SF2C	#6 or #8 Screw Only	2	Natural	36	0.22 [5.5]	1.12 [28.4]	1.12 [28.4]	—
CTB150AAF3C	Acrylic Adhesive or #10 Screw	3	Natural	58	0.39 [10]	1.51 [38.4]	1.51 [38.4]	CTB150AAF3D
CTB150RAF3C0	Rubber Adhesive or #10 Screw	3	UV Black	58	0.39 [10]	1.51 [38.4]	1.51 [38.4]	—
CTB150RAF3D	Rubber Adhesive or #10 Screw	3	Natural	58	0.39 [10]	1.51 [38.4]	1.51 [38.4]	—
CTB150SF3C	#10 Screw Only	3	Natural	58	0.39 [10]	1.51 [38.4]	1.51 [38.4]	—
CTB150RA4C	Rubber Adhesive or #10 Screw	3	Natural	58	0.39 [10]	1.51 [38.4]	1.51 [38.4]	—

## Cable Hangers Nylon 6/6; UV Black / Natural

### UNIRAP™ Cable Hangers Type CH

Cable hangers provide a contact area range of 1/2" to 3/8" in width. All contact edges have a full radius for product protection, and sizes are clearly marked on each clamp.

Cable hangers are injection molded. Available in Natural and UV Black nylon 6/6.

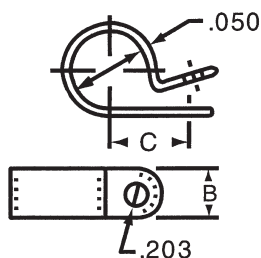

Catalog Number	Mounting Screw	Color	Maximum Bundle Inches [mm]	Dimension B Width Inches [mm]	Dimension C (Mount Hole to Center) Inches [mm]	Bulk Catalog Number
CH2C	#6 - #8 Screw	Natural	0.12 [3.1]	0.38 [9.7]	0.33	CH2M
CH2C0	#6 - #8 Screw	UV Black				—
CH3C	#10 Screw	Natural	0.19 [4.8]		0.43	CH3M
CH3C0	#10 Screw	UV Black				—
CH4C	#10 Screw	Natural	0.25 [6.4]		0.41	CH4M
CH4C0	#10 Screw	UV Black				CH4M0
CH5C	#10 Screw	Natural	0.31 [7.9]		0.50	CH5M
CH5C0	#10 Screw	UV Black				—
CH6C	#10 Screw	Natural	0.38 [9.7]		0.60	CH6M
CH6C0	#10 Screw	UV Black				CH6M0
CH8C	#10 Screw	Natural	0.50 [12.7]		0.61	CH8M
CH8C0	#10 Screw	UV Black				—
CH11C	#10 Screw	Natural	0.62 [15.8]	0.50 [12.7]	0.66	CH11M
CH12C	#10 Screw	Natural				0.75 [19.1]
CH12C0	#10 Screw	UV Black	CH12M0			
CH16C	#10 Screw	Natural	1.00 [25.4]		0.91	CH16M
CH18C	#10 Screw	Natural	1.12 [28.5]			0.97
CH24L	#10 Screw	Natural	1.50 [38.1]		1.19	
CH24C0	#10 Screw	UV Black		—		

# Cable Ties; Stainless Steel Barb Nylon 6/6; UV Black / Natural

## UNIRAP™ Stainless Steel Barb Cable Ties Type CT-SSB

The Stainless Steel Barb cable ties (Type CT-SSB) are nylon 6/6 material featuring self-locking stainless steel barbs and oval low-profile head. There are no sharp edges helping prevent damaged cables. Type CT-SSB ties have a curved tip for faster initial threading and help speed installation. The no slip tail provides an easy grip during tensioning. Type CT-SSB ties are available in Natural and UV Black. These cable ties are cULus Listed for Wiring Positioning devices.



### Features & Benefits

- Nylon 6/6 Standard
- Self-locking stainless steel barb
- Available in UV Black and Natural
- Maximum strength and adjustability for versatility
- Chemically resistant to solvents, oils, grease, and diluted acids
- Rounded edges and bent tail for easy installation
- Safe for air handling spaces
- Plenum Rated



Type 21

Standard Catalog Number	Color	Max Bundle Diameter In. [mm]	Tensile Strength (lbs)	Length Inches [mm]	Width Inches [mm]	Bulk Catalog Number	
CT18087SSBC	Natural	0.87 [22.0]	18	3.94 [100]	0.12 [3.0]	CT18087SSBM	
CT18087SSBC0	UV Black					CT18087SSBM0	
CT18100SSBC	Natural	0.91 [23.1]		4.02 [102]	0.09 [2.0]	CT18100SSBM	
CT18100SSBC0	UV Black					CT18100SSBM0	
CT18200SSBC	Natural	2.01 [51.1]		7.91 [201]		CT18200SSBM	
CT18200SSBC0	UV Black					CT18200SSBM0	
CT40137SSBC	Natural	1.38 [35.1]	40	5.91 [150]		0.14 [3.0]	CT40137SSBM
CT40137SSBC0	UV Black						CT40137SSBM0
CT40200SSBC	Natural	1.97 [50.0]		7.87 [200]	0.15 [4.0]	CT40200SSBD	
CT40200SSBC0	UV Black					CT40200SSBD0	
CT40300SSBC	Natural	3.15 [80.0]		11.18 [284]	0.14 [3.0]	CT40300SSBD	
CT40300SSBC0	UV Black					CT40300SSBD0	
CT40400SSBC	Natural	4.09 [103.9]	14.49 [368]	CT40400SSBD			
CT40400SSBC0	UV Black			CT40400SSBD0			
CT50175SSBC	Natural	1.77 [45.0]	50	7.32 [186]		0.19 [5.0]	CT50175SSBD
CT50175SSBC0	UV Black						CT50175SSBD0
CT50200SSBC	Natural	1.97 [50.0]		7.87 [200]	0.24 [6.0]	CT50200SSBB	
CT50200SSBC0	UV Black					CT50200SSBB0	
CT50250SSBC	Natural	2.56 [65.0]		9.84 [250]	0.19 [5.0]	CT50250SSBB	
CT50250SSBC0	UV Black					CT50250SSBB0	
CT50300SSBC	Natural	3.19 [81.0]	11.61 [295]	CT50300SSBB			
CT50300SSBC0	UV Black			CT50300SSBB0			

## Cable Ties; Stainless Steel Barb Nylon 6/6; UV Black / Natural

## UNIRAP™ Stainless Steel Barb Cable Ties Type CT-SSB (Continued)

Standard Catalog Number	Color	Max Bundle Diameter In. [mm]	Tensile Strength (lbs)	Length Inches [mm]	Width Inches [mm]	Bulk Catalog Number		
CT50400SSBC	Natural	3.94	50	14.33	0.19	CT50400SSBB		
CT50400SSBC0	UV Black	[100.0]		[364]		[5.0]	CT50400SSBB0	
CT50425SSBC	Natural	4.21		14.96		[380]	CT50425SSBB	
CT50425SSBC0	UV Black	[106.9]					CT50425SSBB0	
CT110200SSBC	Natural	2.01	110	8.70	0.28	CT110200SSBB		
CT110200SSBC0	UV Black	[51.1]		[221]		[7.0]	CT110200SSBB0	
CT110225SSBL	Natural	2.24		9.45	0.32	CT110225SSBC		
CT110225SSBL0	UV Black	[57.0]		[240]		[8.0]	CT110225SSBC0	
CT110300SSBL	Natural	2.99		11.81	0.32	CT110300SSBC		
CT110300SSBL0	UV Black	[76.0]				[300]	[8.0]	CT110300SSBC0
CT110325SSBC	Natural	3.15			0.28	[7.0]	CT110325SSBB	
CT110325SSBC0	UV Black	[80.0]					CT110325SSBB0	
CT110350SSBL	Natural	3.62		13.78	0.32	CT110350SSBC		
CT110350SSBL0	UV Black	[92.0]		[350]		[8.0]	CT110350SSBC0	
CT110400SSBL	Natural	4.02		14.88	0.28	CT110400SSBC		
CT110400SSBL0	UV Black	[102.1]				[378]	[7.0]	CT110400SSBC0
CT110500SSBL	Natural	5.00				18.11	[460]	CT110500SSBC
CT110500SSBL0	UV Black	[127.0]						CT110500SSBC0
CT110600SSBL	Natural	5.98				21.18	[538]	CT110600SSBC
CT110600SSBL0	UV Black	[151.9]						CT110600SSBC0
CT110800SSBL	Natural	7.99	27.52			[699]	CT110800SSBC	
CT110800SSBL0	UV Black	[203.0]					CT110800SSBC0	
CT120300SSBL	Natural	3.15	120	0.39	CT120300SSBC			
CT120300SSBL0	UV Black	[80.0]			11.81	[300]	CT120300SSBC0	
CT120350SSBL	Natural	3.82					13.78	[350]
CT120350SSBL0	UV Black	[97.0]			CT120350SSBC0			
CT120400SSBL	Natural	4.33			15.75	[400]	CT120400SSBC	
CT120400SSBL0	UV Black	[110.0]					CT120400SSBC0	
CT120500SSBL	Natural	4.92			17.72	[450]	CT120500SSBC	
CT120500SSBL0	UV Black	[125.0]					CT120500SSBC0	



# Cable Ties; Universal Grade Nylon 6/6; UV Black / Natural

## UNIRAP™ Universal Grade Cable Ties Type CT-UG

General purpose nylon 6/6 ties feature light weight, high strength and a wide temperature range. It is halogen free so it does not release dangerous gases, such as chlorine, bromine, fluorine, or iodine when burned. Nylon 6/6 is hygroscopic, and therefore, absorbs or releases moisture depending on its environment. The moisture level of the material will affect tensile strength, stiffness and elongation of the product.



Type 21

### Features & Benefits

- Nylon 6/6 Standard
- Available in UV Black and Natural
- One piece injection molded
- Maximum strength and adjustability for versatility
- Chemically resistant to solvents, oils, grease, and diluted acids
- Rounded edges and bent tail for easy installation
- Self-locking

Std Pkg Catalog Number	Color	Max. Bundle Dia. (in) [mm]	Min. Tensile Strength (lb)	Length inch [mm]	Width inch [mm]	Bulk Pkg Catalog Number
<b>Nylon UNIRAP - 18 Lb. Tensile Strength</b>						
CT18075CUG	Natural	0.75 [19.1]	18	3.94 [101]	0.10 [2.5]	CT18025MUG
CT18075C0UG	UV Black					CT18025M0UG
—	Natural	2.00 [50.8]		7.95 [202]		CT18200MUG
CT18200C0UG	UV Black					CT18200M0UG
<b>Nylon UNIRAP - 30 Lb. Tensile Strength</b>						
CT30125CUG	Natural	1.25 [31.8]	30	5.90 [150]	0.13 [3.3]	CT30125MUG
CT30125C0UG	UV Black					—
<b>Nylon UNIRAP - 40 Lb. Tensile Strength</b>						
CT40200CUG	Natural	2.00 [50.8]	40	7.90 [201]	0.15 [3.8]	CT40200MUG
CT40400C0UG	UV Black					4.00 [101.6]
<b>Nylon UNIRAP - 50 Lb. Tensile Strength</b>						
CT50175CUG	Natural	1.75 [44.5]	50	7.83 [199]	0.18 [4.6]	CT50175MUG
CT50175C0UG	UV Black					CT50175M0UG
CT50300CUG	Natural	3.00 [76.2]		11.34 [288]		CT50300MUG
CT50300C0UG	UV Black					CT50300M0UG
CT50400CUG	Natural	4.00 [101.6]		14.60 [371]		CT50400MUG
CT50400C0UG	UV Black					—

## Cable Ties; Universal Grade Nylon 6/6; UV Black / Natural

## UNIRAP™ Universal Grade Cable Ties Type CT-UG (Continued)

Std Pkg Catalog Number	Color	Max. Bundle Dia. (in) [mm]	Min. Tensile Strength (lb)	Length inch [mm]	Width inch [mm]	Bulk Pkg Catalog Number
<b>Nylon UNIRAP - 120 Lb. Tensile Strength</b>						
CT120200LOUG	UV Black	2.00 [50.8]	120	8.87 [225]	0.28 [7.1]	—
CT120400LUG	Natural	4.00 [101.6]		14.57 [370]		—
CT120400LOUG	UV Black			17.70 [450]		<b>CT120400C0UG</b>
CT120500CUG	Natural	29.75 [756]				—
CT120900LUG	Natural	9.00 [228.6]				—
<b>Nylon UNIRAP - 175 Lb. Tensile Strength</b>						
CT175400Q0UG	UV Black	4.00 [101.6]	175	15.00 [381]	0.35 [8.9]	—
CT175600QUG	Natural	6.00 [152.4]		21.00 [533]		—
CT175600Q0UG	UV Black			32.00 [813]		—
CT175900Q0UG	UV Black	36.00 [914]				—
CT1751100QUG	Natural	11.00 [279.4]				52.00 [1321]
CT1751100Q0UG	UV Black			—		
CT1751400QUG	Natural	14.00 [355.6]		—		
<b>Nylon UNIRAP - 250 Lb. Tensile Strength</b>						
CT250800Q0UG	UV Black	8.00 [203.2]	250	29.00 [737]	0.50 [12.7]	—

## Universal Grade; Mounting Hole Ties; Adhesive/Screw Bases

### UNIRAP™ Universal Grade Cable Ties with Mounting Hole; Type CT-MH-UG

The CT-MH-UG Cable Ties use the same material and have the same benefits of our CT-UG Cable Ties with the addition of a mounting hole. General purpose nylon 6/6 features light weight, high strength and a wide temperature range. It is halogen free so it does not release dangerous gases, such as chlorine, bromine, fluorine or iodine when burned. Nylon 6/6 is hygroscopic, and therefore, absorbs or releases moisture depending on its environment. Thus, the moisture level of the material will affect tensile strength, stiffness and elongation of the product.



#### Features & Benefits

- Nylon 6/6 Standard
- Available in UV Black and Natural
- One piece injection molded
- Maximum strength and adjustability for versatility
- Chemically resistant to solvents, oils, grease, and diluted acids
- Rounded edges and bent tail for easy installation
- Self-locking

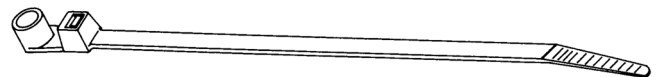

Std Pkg Catalog Number	Color	Screw Size	Max Bundle Diameter Inches [mm]	Min Tensile Strength (lbs)	Length Inches [mm]	Width Inches [mm]
CT50175MH10CUG	Natural	#10	1.75 [44.5]	50	7.79 [198]	0.18 [4.6]
CT50175MH10C0UG	UV Black			50		
CT50300MH10CUG	Natural		3.00 [76.2]	50	11.73 [298]	
CT50300MH10C0UG	UV Black			50		

### UNIRAP™ Universal Grade Cable Tie Mounting Bases; Type CTB-UG

These cable tie mounting bases may be secured with 2 screws and/or a rubber-based adhesive for ease of applications and stability. These bases are suited for many applications to stabilize and secure wire bundles, both indoors and outdoors.

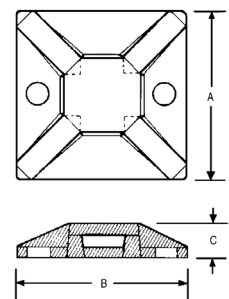

#### Features & Benefits

- Nylon 6/6 Standard
- Chemically resistant to solvents, oils, grease, and diluted acids

Std Pkg Catalog Number	Mounting Method	Max Tie Slot Width [mm]	Dimension A [mm]	Dimension B [mm]	Dimension C [mm]	Bulk Catalog Number
CTB075RA4CUG	Rubber Adhesive	0.14 [3.56]	0.75 [19.0]	0.75 [19.0]	0.15 [3.8]	—
CTB125RA4CUG	Rubber Adhesive	0.20 [5.08]	1.125 [28.6]	1.125 [28.6]	0.19 [4.8]	CTB125RA4DUG

## Cable Tie Variety Canisters Nylon 12 Cable Ties; UV Black / Natural

### UNIRAP™ Cable Tie Variety Canister Type CTASST

There are times when a variety of lengths and color would be helpful. The Type CTASST Cable Tie Variety Canister is perfect when your needs change.



Catalog Number	Contains					
	Quantity	Color	Max Bundle Diameter	Tensile Strength (lbs)	Length Inches [mm]	Width Inches [mm]
CTASST	100	Natural	0.75 [19.1]	18	3.94 [100]	0.10 [2.5]
	100	UV Black				
	200	Natural	1.75 [44.5]	50	7.99 [203]	0.13 [3.2]
	100	UV Black				
	50	Natural	3.00 [76.2]	50	11.02 [280]	0.19 [4.8]
	50	UV Black				

### UNIRAP™ Nylon 12 Cable Ties Type CTNT

Nylon 12 cable ties provide excellent UV, chemical and moisture resistance. The ties feature inside serrations and a bent tail for quick and easy installation. Manufactured from polyamide 12 the ties also have a smooth edge to prevent bundle damage. Especially suitable in high moisture, corrosive (zinc chloride and dilute acids) environments or where low temperatures are a factor. Indoor or outdoor applications.

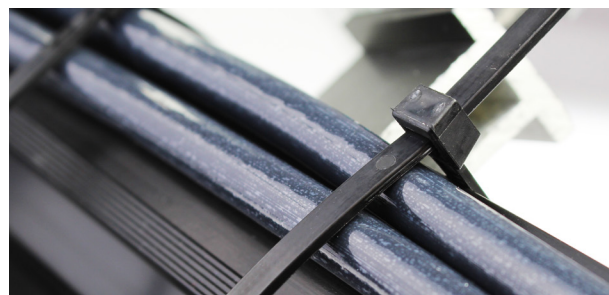

CABLE TIE  
33TX

Std Pkg Catalog Number	Color	Max. Bundle Dia. In. [mm]	Min. Tensile Strength (lb)	Length	Width	Bulk Pkg Catalog Number
				in [mm]	in [mm]	
CTNT50200C0	UV Black	2.00 [50]	50	7.50 [190]	0.19 [4.8]	CTNT50200D0
CTNT50275C0	UV Black	2.75 [70]		11.00 [280]		CTNT50275D0
CTNT50350C0	UV Black	3.50 [90]		13.78 [350]		CTNT50350D0
CTNT120600L0	UV Black	6.00 [152]	120	24.00 [609]	0.31 [7.0]	—

# VELCRO® Hook and Loop Straps; TEFZEL® Fluoropolymer Ties

## VELCRO® Hook and Loop Straps Type TFV-B

Reusable and flexible, hook and loop straps are a unique self-gripping fastening system. These ties are specifically used on fiberoptic applications.

The TFV-V2 flame retardant straps are UL Listed Wire Positioning Devices (ZODZ), UL94-V2 rated for use in air handling spaces in accordance with the NEC Section 300-22(c) and (d). Perfect for plenum areas.

25 straps are conveniently packaged in each polybag.

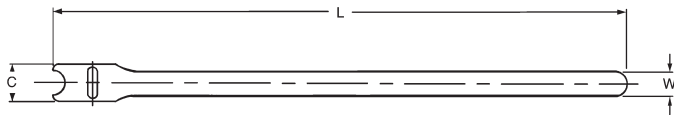

Catalog Number	Product Description	Max Bundle Diameter [mm]	C [mm]	L [mm]	W [mm]	T	Avg. Sheer (PSI)	Avg. Peel (PIW)	Pkg. Qty.
TFV3B12V2	VELCRO® hook and loop strap, 3/4" x 12", Black, 25pk	3.00 [76.2]	0.75 [19.1]	12.00 [305]	0.50 [27]	0.09	29	0.60	1 package = 25 ties
TFV3B18V2	VELCRO® hook and loop strap, 3/4" x 18", Black, 25pk	5.00 [127.0]		18.00 [457]			29	0.60	
TFV3B6V2	VELCRO® hook and loop strap, 3/4" x 6", Black, 25pk	1.00 [25.4]		6.00 [152]			29	0.60	
TFV3BLU12	VELCRO® hook and loop strap, 3/4" x 12", Royal Blue, 25pk	3.00 [76.2]		12.00 [305]			23	0.50	
TFV3BLU18	VELCRO® hook and loop strap, 3/4" x 18", Royal Blue, 25pk	5.00 [127.0]		18.00 [457]			23	0.50	

## TEFZEL® Cable Ties Type CTZ

TEFZEL® Fluoropolymer ties feature a low smoke density with excellent flammability rating (UL 94V-0) and tolerates extreme high and low temperatures. TEFZEL® ties come in distinctive aqua blue color with an operating temperature of Min. -112°F (-80°C), Max. 338°F (170°C).

TEFZEL® is a Registered trademark of E.I. du Pont de Nemours and Company.



Catalog Number	Tensile	Max Bundle Diameter	Length	Pkg Qty
CTZ18075C6	18 lb	.87"	4.00"	100
CTZ18125C6	18 lb	1.39"	6.25"	100
CTZ30200C6	30 lb	2.00"	4.00"	100
CTZ50175C6	50 lb	1.75"	7.75"	100
CTZ50300C6	50 lb	3.00"	11.00"	100
CTZ50400C6	50 lb	4.00"	14.50"	100
CTZ100300C6	100 lb	3.00"	11.00"	50
CTZ100400C6	100 lb	4.00"	14.50"	50

## Stainless Steel Cable Ties; Grade 304, Uncoated

### UNIRAP™ Grade 304 Stainless Steel; Uncoated Type CTSS

BURNDY® 304 Stainless Steel ties are designed to secure hoses, cables, poles, pipes, and more when harsh environmental conditions may adversely affect the bundling application.

Used where corrosion, vibration, weathering, radiation, and temperature extremes are a concern. BURNDY® Stainless Steel ties can be used in virtually any indoor, outdoor, and underground application.

These Stainless Steel ties are made from Grade 304 Stainless Steel. Designed with a low profile clamping bearing head with fully adjustable strap accommodating many bundle diameters.



#### Features & Benefits

- Meet ABS Requirements
- 304 Grade Stainless Steel
- Suitable for general purpose applications
- Smooth, rounded edges help ensure safe, efficient handling
- Available in a variety of lengths and widths
- Self-locking steel ball design speeds installation and locks into place at any length
- Provides a strong, durable method of cable bundling
- Flame retardant and non-toxic for applications where safety from fire is critical

Catalog Number	Material	Max Bundle Diameter In. [mm]	Min Tensile Strength Lbs.	Length Inches [mm]	Width Inches [mm]	Installation Tool
CTSS225100304C	304 SS	0.99 [25.2]	225	3.94 [100]	0.18 [4.6]	CTSS900
CTSS225200304C		1.97 [50.0]		7.87 [200]		
CTSS225300304C		3.00 [76.2]		11.81 [300]		
CTSS225400304C		4.02 [102.1]		15.75 [400]		
CTSS225500304C		5.04 [128.0]		19.68 [500]		
CTSS225600304C		6.07 [154.2]		23.62 [600]		
CTSS500200304L	304 SS	1.97 [50.0]	500	7.87 [200]	0.31 [7.9]	CTSS900
CTSS500300304L		3.00 [76.2]		11.81 [300]		
CTSS500400304L		4.02 [102.1]		15.75 [400]		
CTSS500500304L		5.04 [128.0]		19.68 [500]		
CTSS500600304L		6.07 [154.2]		23.62 [600]		
CTSS500700304L		7.09 [180.1]		27.56 [700]		
CTSS500750304L		7.60 [193.0]		31.50 [800]		
CTSS500800304L		8.12 [206.3]		39.37 [1000]		
CTSS700200304L	304 SS	1.97 [50.0]	700	7.87 [200]	0.50 [12.7]	CTSS900
CTSS700300304L		3.00 [76.2]		11.81 [300]		
CTSS700400304L		4.02 [102.1]		15.75 [400]		
CTSS700500304L		5.04 [128.0]		19.68 [500]		
CTSS700600304L		6.07 [154.2]		23.62 [600]		
CTSS700700304L		7.09 [180.1]		27.56 [700]		
CTSS700800304L		8.12 [206.3]		39.37 [1000]		
CTSS900200304L	304 SS	1.97 [50.0]	920	7.87 [200]	0.62 [15.9]	CTSS900
CTSS900300304L		3.00 [76.2]		11.81 [300]		
CTSS900400304L		4.02 [102.1]		15.75 [400]		
CTSS900500304L		5.04 [128.0]		19.68 [500]		
CTSS900600304L		6.07 [154.2]		23.62 [600]		
CTSS900700304L		7.09 [180.1]		27.56 [700]		
CTSS900800304L		8.12 [206.3]		39.37 [1000]		

## Stainless Steel Cable Ties; Grade 304, Partially Coated

### UNIRAP™ Grade 304 Stainless Steel; Partially Coated; Type CTSS-PC

BURNDY® Stainless Steel Partially Coated cable ties (Type CTSS-PC) are designed with a steel ball self-locking mechanism. There are no sharp edges which prevents damaged cables. These ties have smooth, rounded edges and polyester coating which add to the safety of the installer. High tensile strength along with the shield of the polyester coating offer a reliable and lasting bundling solution. CTSS-PC ties are currently available in black. BURNDY® Stainless Steel Partially Coated Cable Ties can be used in any indoor, outdoor, or underground application.



#### Features & Benefits

- Meet ABS Requirements
- 304 Grade Stainless Steel
- Available in Black only
- Suitable for general purpose applications
- Smooth, rounded edges along with the polyester coating add to the safety of the installer
- Self-locking steel ball design speeds installation and locks into place at any length
- Provides a strong, durable method of cable bundling
- Available in a wide range of lengths and widths
- Halogen free low smoke polyester coating

Catalog Number	Material	Max Bundle Diameter In. [mm]	Min Tensile Strength Lbs.	Length Inches [mm]	Width Inches [mm]	Installation Tool
CTSS250200PC304L	304 SS	1.97 [50.0]	270	7.87 [200]	0.31 [7.9]	CTSS900
CTSS250300PC304L		3.00 [76.2]		11.81 [300]		
CTSS250400PC304L		4.02 [102.1]		15.75 [400]		
CTSS250500PC304L		5.04 [128.0]		19.68 [500]		
CTSS250600PC304L		6.06 [153.9]		23.62 [600]		
CTSS250700PC304L		7.09 [180.1]		27.56 [700]		
CTSS250800PC304L		8.11 [206.0]		39.37 [1000]		
CTSS450200PC304L	304 SS	1.97 [50.0]	450	7.87 [200]	0.50 [12.7]	CTSS900
CTSS450300PC304L		3.00 [76.2]		11.81 [300]		
CTSS450400PC304L		4.02 [102.1]		15.75 [400]		
CTSS450500PC304L		5.04 [128.0]		19.68 [500]		
CTSS450600PC304L		6.06 [153.9]		23.62 [600]		
CTSS450700PC304L		7.09 [180.1]		27.56 [700]		
CTSS450800PC304L		8.11 [206.0]		39.37 [1000]		
CTSS675200PC304Q	304 SS	1.97 [50.0]	675	7.87 [200]	0.62 [15.9]	CTSS900
CTSS675300PC304Q		3.00 [76.2]		11.81 [300]		
CTSS675400PC304Q		4.02 [102.1]		15.75 [400]		
CTSS675500PC304Q		5.04 [128.0]		19.68 [500]		
CTSS675600PC304Q		6.06 [153.9]		23.62 [600]		
CTSS675700PC304Q		7.09 [180.1]		27.56 [700]		
CTSS675800PC304Q		8.11 [206.0]		39.37 [1000]		



## Stainless Steel Cable Ties; Grade 304, Fully Coated

### UNIRAP™ Grade 304 Stainless Steel; Fully Coated; Type CTSS-FC

The Stainless Steel Fully Coated cable ties (Type CTSS-FC) are designed with a steel ball type locking mechanism. There are no sharp edges which prevents damaged cables. These ties have smooth, rounded edges and polyester coating which add to the safety of the installer. High tensile strength along with the shield of the polyester coating offers a reliable and lasting bundling solution. Type CTSS-FC ties are currently available only in black. BURNDY® stainless steel fully coated cable ties can be used in any indoor, outdoor, or underground application.

#### Features & Benefits

- Meet ABS Requirements
- 304 Grade Stainless Steel
- Available in Black only
- Suitable for general purpose applications
- Smooth, rounded edges along with the polyester coating add to the safety of the installer
- Self-locking steel ball design speeds installation and locks into place at any length
- Provides a strong, durable method of cable bundling
- Available in a wide range of lengths and widths
- Halogen free low smoke polyester coating



Catalog Number	Material	Max Bundle Diameter In. [mm]	Min Tensile Strength Lbs.	Length Inches [mm]	Width Inches [mm]	Installation Tool
CTSS100100FC304C	304 SS	0.98 [24.9]	160	3.94 [100]	0.18 [4.6]	CTSS900
CTSS100200FC304C		1.97 [50.0]		7.87 [200]		
CTSS100300FC304C		3.00 [76.2]		11.81 [300]		
CTSS100400FC304C		4.02 [102.1]		15.75 [400]		
CTSS100500FC304C		5.04 [128.0]		19.68 [500]		
CTSS100600FC304C		6.07 [154.2]		23.62 [600]		
CTSS100800FC304C		8.11 [206.0]		31.50 [800]		
CTSS250200FC304L	304 SS	1.97 [50.0]	250	7.87 [200]	0.31 [7.9]	CTSS900
CTSS250300FC304L		3.00 [76.2]		11.81 [300]		
CTSS250400FC304L		4.02 [102.1]		15.75 [400]		
CTSS250500FC304L		5.04 [128.0]		19.68 [500]		
CTSS250600FC304L		6.06 [153.9]		23.62 [600]		
CTSS250700FC304L		7.09 [180.1]		27.56 [700]		
CTSS250800FC304L		8.11 [206.0]		39.37 [1000]		
CTSS450200FC304L	304 SS	1.97 [50.0]	450	7.87 [200]	0.50 [12.7]	CTSS900
CTSS450300FC304L		3.00 [76.2]		11.81 [300]		
CTSS450400FC304L		4.02 [102.1]		15.75 [400]		
CTSS450500FC304L		5.04 [128.0]		19.68 [500]		
CTSS450600FC304L		6.06 [153.9]		23.62 [600]		
CTSS450700FC304L		7.09 [180.1]		27.56 [700]		
CTSS450800FC304L		8.11 [206.0]		39.37 [1000]		
CTSS675200FC304Q	304 SS	1.97 [50.0]	675	7.87 [200]	0.62 [15.9]	CTSS900
CTSS675300FC304Q		3.00 [76.2]		11.81 [300]		
CTSS675400FC304Q		4.02 [102.1]		15.75 [400]		
CTSS675500FC304Q		5.04 [128.0]		19.68 [500]		
CTSS675600FC304Q		6.06 [153.9]		23.62 [600]		
CTSS675700FC304Q		7.09 [180.1]		27.56 [700]		
CTSS675800FC304Q		8.11 [206.0]		39.37 [1000]		



# Wiley Wire Management Straps

## Wiley Bundle Straps

### 304 Stainless Steel Wire Covered with Vinyl Jacket

The Wiley Bundle Strap is made of corrosion resistant 304 stainless steel, which makes for a durable, long lasting and reliable solution for all environments. The vinyl jacket covering the stainless steel wire is designed to protect cable insulation from damage. The Wiley Bundle Strap is easy to install and can be crimped in the field with electrician linesman pliers or standard wire cutters. The crimp sleeve's retention feature allows for a quick, effortless, secure installation. Custom lengths available upon request.

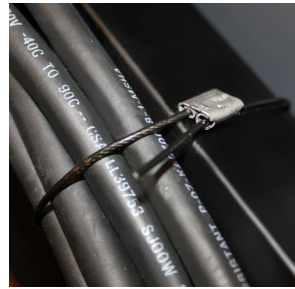

### Features & Benefits

- UL 62275 Listed, RoHS compliant
- High quality, long-lasting, labor saving, wire management solution
- UV rated vinyl vinyl jacketed stainless steel wire with 304 stainless steel crimp
- Vinyl jacket designed to protect cable insulation from damage
- 304 stainless steel crimp sleeve allows for quick and easy installation
- Can be crimped in the field with electrician lineman pliers or standard wire cutters
- Retention feature allows for a quick, effortless, securing installation
- Lasts for the lifetime of the PV system
- Custom lengths available upon request

### Wiley Bundle Straps

304 Stainless Steel wire covered with vinyl jacket helps protect cable insulation from damage

Catalog Number	Length inch [mm]	Max. Bundle Diameter inch [mm]	Diameter inch [mm]	Max. Tensile Strength	Material
WBS8V	8.00 [203.20]	2.30 [58.40]	0.06 [1.50]	100 lbs.	Vinyl Covered 304 Stainless Steel Wire
WBS10V	10.00 [254.00]	2.92 [74.00]			
WBS12V	12.00 [304.80]	3.88 [98.50]			
WBS14V	14.00 [356.00]	4.20 [106.70]			
WBS20V	20.00 [508.00]	6.36 [161.50]			
WBS24V	24.00 [609.60]	7.00 [178.00]			
WBS30V	30.00 [762.00]	8.75 [222.00]			
WBS36V	36.00 [914.40]	11.00 [279.40]			

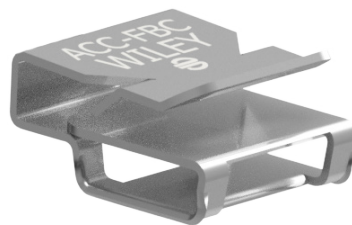

ACC-FBC shown with WBS8V

### Mounting Platform for WBS Bundle Straps or UNIRAP™ Cable Ties

304 Stainless Steel cable clip used for affixing cable ties to a module flange or similar flange.

Catalog Number	Length inch [mm]	Width inch [mm]	Height inch [mm]	Max. Cable Tie Width inch [mm]	Frame Thickness
ACC-FBC	0.55 [14.00]	0.48 [12.20]	0.27 [7.00]	0.31 [8.00]	1.3mm to 2.5mm

## Wiley Wire Management Twist Straps

### Wiley Twist Straps

The innovative Wiley Twist Strap (WTS) provides a quick, dependable wire management solution. As easy to use as a cable tie, while offering the durability of a bundle strap. The corrosion-resistant 300 series stainless steel wire core is coated with UV-resistant PVC. The round geometry eliminates the risk of sharp edges cutting into PV cable jackets.

To use, insert the stem into twisted eye loop and fold over for a tested tensile strength of up to 40 lbs. With lengths varying from 8” to 36”, the WTS can be used to secure wires almost anywhere on a PV system, including around the torque tube!



### Features & Benefits

- Durable, labor saving solution
- Non-corrosion 300 series stainless steel core
- UV Resistant PVC coating
- Reusable / Repositional
- No tools necessary for installation or removal
- Custom lengths available upon request
- UL62275 pending

<b>Wiley Twist Straps</b>					
<i>300 Series Stainless Steel Wire with UV Resistant PVC Coating</i>					
Catalog Number	Length inch [mm]	Max. Bundle Diameter inch [mm]	Diameter inch [mm]	Max. Tensile Strength	Material
<b>WTS8</b>	8.00 [203.20]	1.75 [44.00]	0.075 [1.90]	40 lbs.	UV Resistant PVC over 300 Series Stainless Steel Wire
<b>WTS12</b>	12.00 [304.80]	3.00 [76.00]			
<b>WTS18</b>	18.00 [457.20]	4.50 [114.00]			
<b>WTS24</b>	24.00 [609.60]	6.00 [152.00]			
<b>WTS30</b>	30.00 [762.00]	7.50 [190.00]			
<b>WTS36</b>	36.00 [914.40]	9.00 [229.00]			

# Wiley Cable Hanger Family

## WCH - Wiley Cable Hanger Family

The Wiley Cable Hanger Family is designed specifically to support cables and fuses via module frame mounting or wire management holes or secured at the tracker system level in a fast, easy one step application. With models oriented either straight-on or at a 90° angle, there are options for both traditional and bi-facial modules. The round cross-section of the hangers ensures the cable insulation is protected from chafing in high wind and tracker movement. Offered in either stainless or galvanized steel construction, both provide a solution made to last. Many of our hanger options are now available in easy-to-use bundle packages. All hanger types except the WCHJ type are UL1565.

### Tracker Level

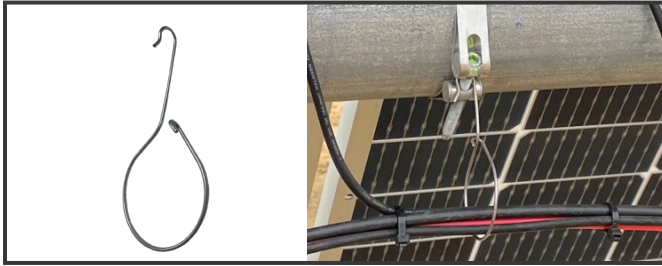

WCH2H1090

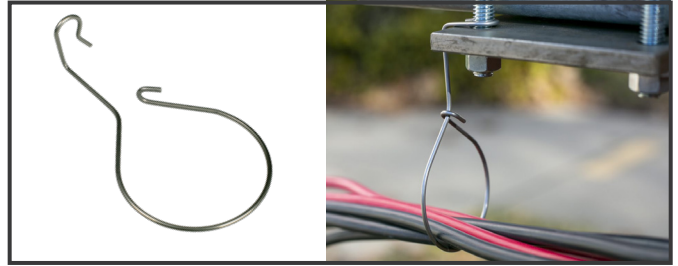

WCH2B10

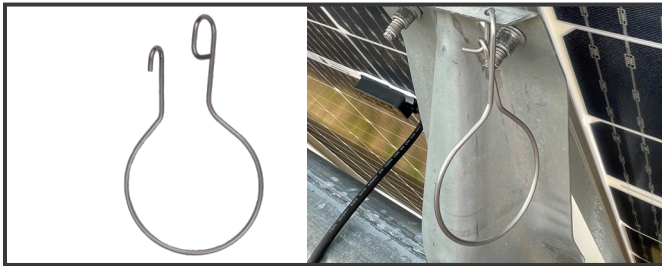

WCH2H2090



WCH15ATI / WCH15ATIGS

### Module Level



WCH1 / WCH2



WCH2P

### Fuse Holder



WFHP115 / WFHP085

### Bearing Jumper



WCHJ-30HH

# Wiley Cable Hanger Family

## Wiley Cable Hanger Family (Continued)

### Features and Benefits

- Easy Installation
- Available in Stainless or Galvanized Steel
- Round cross section insures cable insulation protection
- Models for both module and tracker level
- Most models available in bundle package eliminating need to untangle before use
- UL1565 Listed



Catalog Number Standard Packaging	Catalog Number Bundled Packaging	Material	Bundle Diameter	Wire Quantity	Installation Location	Tracker System
<b>Wire Management Hangers</b>						
<b>WCH1</b>	<b>WCH1-BDL</b>	300 Series Stainless Steel	1.0" [25.4mm]	Up to 8 PV wires	Mounting/Wire Mgmt Hole	-
<b>WCH1GS</b>	<b>WCH1GS-BDL</b>	Galvanized Steel	1.0" [25.4mm]	Up to 8 PV wires	Mounting/Wire Mgmt Hole	-
<b>WCH2</b>	<b>WCH2-BDL</b>	300 Series Stainless Steel	2.0" [50.8mm]	Up to 20 PV wires	Mounting/Wire Mgmt Hole	-
<b>WCH2GS</b>	<b>WCH2GS-BDL</b>	Galvanized Steel	2.0" [50.8mm]	Up to 20 PV wires	Mounting/Wire Mgmt Hole	-
<b>WCHP2</b>	-	300 Series Stainless Steel	2.0" [50.8mm]	Up to 20 PV wires	Mounting/Wire Mgmt Hole	-
<b>WCHP2GS</b>	-	Galvanized Steel	2.0" [50.8mm]	Up to 20 PV wires	Mounting/Wire Mgmt Hole	-
<b>WCH2-90-15</b>	<b>WCH2-90-15-BDL</b>	300 Series Stainless Steel	2.0" [50.8mm]	Up to 20 PV wires	Mounting/Wire Mgmt Hole or Tracker Bolt	NexTracker™ (U Bolt) and similar
<b>WCH2-90-15GS</b>	<b>WCH2-90-15GS-BDL</b>	Galvanized Steel	2.0" [50.8mm]	Up to 20 PV wires	Mounting/Wire Mgmt Hole or Tracker Bolt	NexTracker™ (U Bolt) and similar
<b>WCH2B10</b>	<b>WCH2B10-BDL</b>	300 Series Stainless Steel	2.0" [50.8mm]	Up to 20 PV wires	Tracker Bolt	FTC and Similar
<b>WCH2B10GS</b>	<b>WCH2B10GS-BDL</b>	Galvanized Steel	2.0" [50.8mm]	Up to 20 PV wires	Tracker Bolt	FTC and Similar
<b>WCH2H1090</b>	<b>WCH2H1090-BDL</b>	300 Series Stainless Steel	2.0" [50.8mm]	Up to 20 PV wires	Tracker Bolt	NexTracker™ (strap bracket) and similar
<b>WCH2H1090GS</b>	<b>WCH2H1090GS-BDL</b>	Galvanized Steel	2.0" [50.8mm]	Up to 20 PV wires	Tracker Bolt	NexTracker™ (strap bracket) and similar
<b>WCH15ATI</b>	-	300 Series Stainless Steel	1.5" [38.1mm]	Up to 15 PV wires	Tracker Mounting Bracket	ATI & Similar
<b>WCH15ATIGS</b>	-	Galvanized Steel	1.5" [38.1mm]	Up to 15 PV wires	Tracker Mounting Bracket	ATI & Similar
<b>Fuse Holder Hangers</b>						
<b>WFHP115</b>	-	300 Series Stainless Steel	1.15" [29.2mm]	-	Mounting/Wire Mgmt Hole	-
<b>WFHP115GS</b>	-	Galvanized Steel	1.15" [29.2mm]	-	Mounting/Wire Mgmt Hole	-
<b>WFHP085</b>	-	300 Series Stainless Steel	0.85" [21.6mm]	-	Mounting/Wire Mgmt Hole	-
<b>WFHP085GS</b>	-	Galvanized Steel	0.85" [21.6mm]	-	Mounting/Wire Mgmt Hole	-
<b>Bearing Jumper</b>						
<b>WCHJ-30HH*</b>	-	300 Series Stainless Steel	N/A	-	Mounting Hole	NexTracker™ w/First Solar S7 Modules
<b>WCHJ-30HHGS*</b>	-	Galvanized Steel	N/A	-	Mounting Hole	NexTracker™ w/First Solar S7 Modules

\* Not UL Listed



## Coated P-Clips

### Protect cables from Vibration and Insulation Damage

Wiley coated P-Clips provide a durable, long lasting and reliable solution for protecting wires and cables. The vinyl coating acts as a shield against vibration and cable insulation damage. Wiley coated P-Clips easily install into a mounting hole with 1/4" hardware.



<b>Wiley Coated P-Clips</b>				
<i>Vinyl coated steel p-clips protect cables from vibration and insulation damage.</i>				
Catalog Number	Width inch [mm]	Max. Bundle Diameter inch [mm]	Material	UL
WIPC14-14	0.24 [6.0]	0.25 [6.4]	PVC coated zinc plated steel	UL 1565 Listed
WIPC14-12	0.24 [6.0]	0.50 [13.0]		
WIPC14-34	0.24 [6.0]	0.75 [19.0]		
WIPC14-1	0.24 [6.0]	1.00 [25.4]		
WIPC14-112	0.24 [6.0]	1.50 [38.0]		

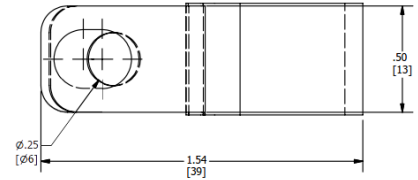

# Wiley Cable Clips

## Wiley Cable Clips

### High-quality wire management solutions

Engineered for high-quality wire management solutions, Wiley Cable Clips simplify wire management and create a cleaner aesthetic to solar PV arrays. The clips are made of corrosion resistant stainless steel, which makes for a durable, long lasting and reliable solution in all environments and are designed with coined and rolled edges to prevent damage to cable insulation. The designs are easy to install and remove with a flat head screwdriver. The clips can be used in a wide variety of mounting configurations (including 90 and 180 degrees) for module and rail applications. Custom designs are available upon request.

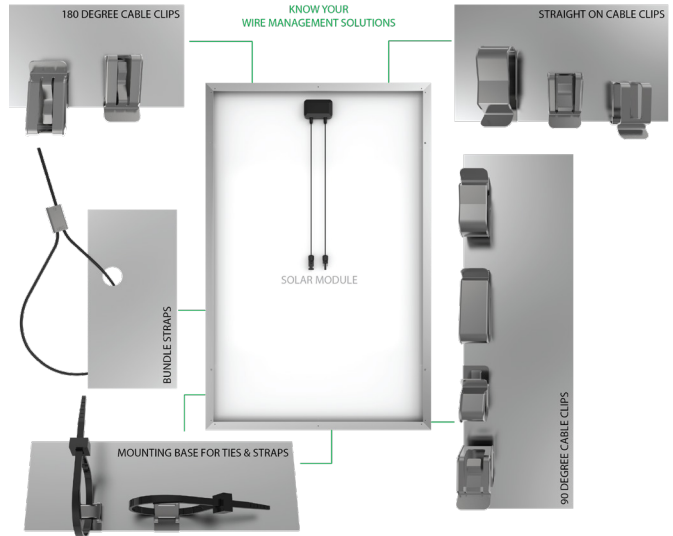

### Features and Benefits

- UL 1565 Listed
- Accommodates a broad range of cable combinations and sizes (e.g., USE-2, PV, AC module, and micro inverter cables)
- Environmentally tested - UL 2703 and ASTM B117
- No tools required for installation
- Coined and rolled edges to prevent damage to cable insulation
- Reliability for use throughout the lifetime of the PV system















### Flange Clips

304 Stainless Steel cable clips that install on the module frame or other equipment flange.

Line Image	Catalog Number	Qty of Wires Held	Wire Diameter inch [mm]	Flange Thickness Accommodated
	<b>ACC</b>	1 to 2 USE-2 wires or 1 PV wire	Max. 0.216 [5.50]	1.3 - 2.5mm
	<b>ACC-PV</b>	1 to 2 PV wires	Max. 0.275 [7.00]	1.3 - 2.5mm
	<b>ACC-FPV</b>	1 to 2 PV wires	Max. 0.314 [8.00]	1.0 - 3mm

**Wiley Cable Clips (Continued)**

<b>90 Degree Flange Clips</b>				
<i>304 Stainless Steel cable clips that install parallel or perpendicular on the module frame or other equipment flange.</i>				
Line Image	Catalog Number	Qty of Wires Held	Wire Diameter inch [mm]	Flange Thickness Accommodated
	<b>ACC-F90-1</b>	1 to 2 USE-2 wires or 1 to 2 PV wire	Max. 0.29 [7.50]	1.3 - 2.5mm
	<b>ACC-FPV90</b>	1 to 2 PV wires	Max. 0.314 [8.00]	1.0 - 3.0mm
	<b>ACC-F2-90</b>	1 to 2 Micro Inverter Trunk or AC cables	1 wire: Max. 0.55 [14.00] 2 wires Max. 0.43 [11.00]	1.3 - 2.5mm
	<b>ACC-F4-90-1</b>	1 to 4 PV wires	Max. 0.29 [7.50]	1.3 - 2.5mm
	<b>ACC-F490</b>	1 to 4 PV wires	Max. 0.314 [8.00]	1.0 - 3.0mm
	<b>ACC-F4F</b>	1 to 4 PV wires	Max. 0.314 [8.00]	1.0 - 3.0mm
	<b>ACC-F1-270</b>	2 PV wire or 1 Micro Inverter Trunk	Max. 0.55 [14.00]	1.0 - 3.0mm
<b>180 Degree Flange Clips</b>				
<i>304 Stainless Steel cable clips that install on the flange at 180 degrees.</i>				
Line Image	Catalog Number	Qty of Wires Held	Wire Diameter inch [mm]	Flange Thickness Accommodated
	<b>ACC-FPV180</b>	1 to 2 PV wires	Max. 0.314 [8.00]	1.0 - 3.0mm
	<b>ACC-F1-270</b>	1 to 2 PV wires or 1 Micro Inverter Trunk	Max. 0.55 [14.00]	1.0 - 3.0mm
	<b>ACC-FF180</b>	1 to 2 PV wires	Max. 0.314 [8.00]	1.0 - 3.0mm
<b>Rail Clips</b>				
<i>304 Stainless Steel cable clips that install on the rail, channel, or slot.</i>				
Line Image	Catalog Number	Qty of Wires Held	Wire Diameter inch [mm]	Rail Type
	<b>ACC-R2</b>	1 to 2 Micro Inverter Trunk or AC cables	1 wire: Max. 0.55 [14.00] 2 wires Max. 0.43 [11.00]	Unirac, Ironrige or Similar Style
	<b>ACC-R4</b>	1 to 4 PV wires	Max. 0.29 [7.50]	Unirac, Ironrige or Similar Style
	<b>ACC-RBC15</b>	2 Micro Inverter Trunk or up to 4 PV wires	Max. 0.55 [14.00]	Rail Channel or Slot Width: 6.35mm to 13.5mm



ACC-F90-1 shown in both orientations



ACC-F1-270



ACC-FPV180

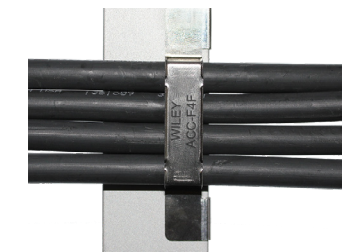

ACC-F4F

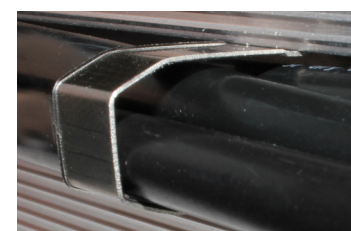

ACC-RBC15 shown

# Wiley Edge Clip with Cable Tie

## Wiley Edge Clip with Cable Tie (ACC-ECT) High-quality wire management solutions

The WILEY ACC-ECT is the perfect solution to route cable bundles without the need for mounting holes or additional hardware. The ACC-ECT is a nylon-encased plated steel clip that installs onto the module frame flange and allows a cable tie to be routed in both landscape (on the horizontal/perpendicular portion of the module frame) and portrait (on the vertical/parallel portion of the module frame) orientations. The ACC-ECT is available in UV resistant, high impact heat stabilized nylon 6/6 and nylon 12 material; both the 6/6 and 12 have a tensile strength of 50 lb. Nylon 12 makes the ACC-ECT especially suitable in high moisture, corrosive environments or where low temperatures are a factor.

### Features and Benefits

- Route cable bundles without the need for mounting holes or additional hardware
- Installs in a vertical/parallel (90°) or horizontal/perpendicular (180°) orientation
- Steel lances securely anchor clips to module frames or purlins
- Offered in various nylon types with 50 lb tensile strength:
  - UV resistant, high impact heat stabilized Nylon 6/6
  - UV resistant Nylon 12 which provides excellent UV, chemical and moisture resistance

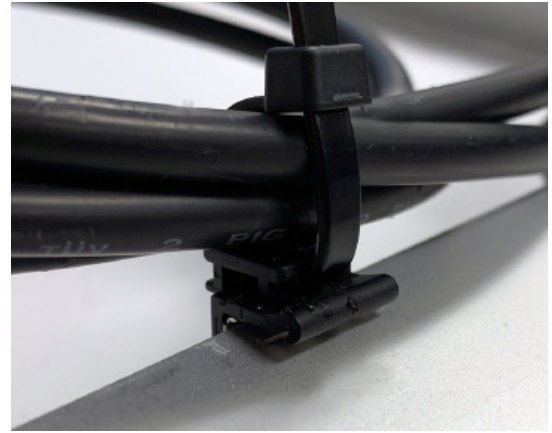

Style A - Vertical/Parallel Installation



Style B - Horizontal/Perpendicular Installation

Style A - Vertical/Parallel Installation

Style B - Horizontal/Perpendicular Installation

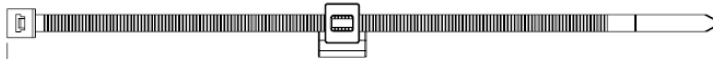

Part Key		
<b>Family</b>	ACC	Acme Cable Clip
<b>Type</b>	ECT	Edge Clip Tie
<b>Style</b>	A	Vertical/Parallel (90°) Installation
	B	Horizontal/Perpendicular (180°) Installation

Catalog Number (Standard Flange)	Flange Size	Catalog Number (Wide Flange)	Flange Size	Style	Nylon Type	Cable Tie Length	Max. Bundle Dia.	
ACC-ECTA68	1.3 - 3.0mm	ACC-ECTWA68	3.0 - 6.0mm	A	6/6	8" / 200mm	1.95" / 49.5mm	
ACC-ECTA611		ACC-ECTWA611				11" / 280mm	2.95" / 74.8mm	
ACC-ECTA614		ACC-ECTWA614				14" / 360mm	3.94" / 100mm	
ACC-ECTA128		ACC-ECTWA128			8" / 200mm	1.95" / 49.5mm		
ACC-ECTA1211		ACC-ECTWA1211			11" / 280mm	2.95" / 74.8mm		
ACC-ECTA1214		ACC-ECTWA1214			14" / 360mm	3.94" / 100mm		
ACC-ECTB68		B		ACC-ECTWB68	6/6	6/6	8" / 200mm	1.95" / 49.5mm
ACC-ECTB611				ACC-ECTWB611			11" / 280mm	2.95" / 74.8mm
ACC-ECTB614				ACC-ECTWB614			14" / 360mm	3.94" / 100mm
ACC-ECTB128				ACC-ECTWB128		8" / 200mm	1.95" / 49.5mm	
ACC-ECTB1211				ACC-ECTWB1211		11" / 280mm	2.95" / 74.8mm	
ACC-ECTB1214				ACC-ECTWB1214		14" / 360mm	3.94" / 100mm	

### Edge Clip Compartment

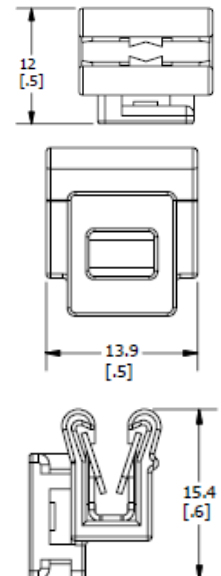



## Cable Tie Installation Tooling; 145PTAG 94VO Nylon Tag

### Cable Tie Tools Types CTTSS

Ergonomics and the prevention of repetitive motion injuries, coupled with the need to continually improve assembly efficiencies and procedures, are a major concern with most cable tie users. BURNDY® cable tie tools effectively address both issues. BURNDY® has world class cable tie tools to complement its line of quality cable ties. These tools are truly state-of-the-art both in design and performance.

BURNDY® tools make it easier for operators to install cable ties, while maintaining correct tension and flush cut-off. Worker safety is further enhanced as the tools can eliminate the sharp edges of a cut-off cable tie.

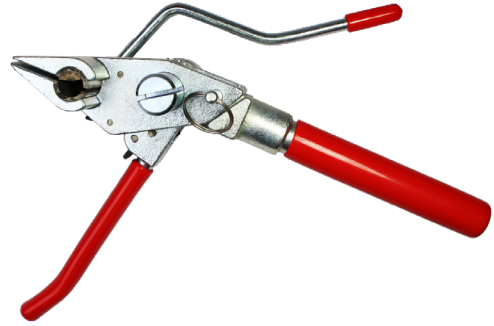

Catalog Number	Description	For Use On
CTTSS900	Stainless Steel Tie Tool	SS Ties up to 900 lbs

### 145PTAG 94VO Rated Nylon Tag

Designed originally for the telecom market, this tag is applicable anywhere the need to mark tags in the field exists. Typically secured to cabling using a multi-ply cord or cable tie, or waxed cord. The tags may be written on in most inks or using a permanent marker. Durable, flame retardant, white nylon tag 94VO rated.

Dimensions: 1" x 1-3/4"

**Catalog Number: 145PTAG**

