



Main

Range of product	Zelio Relay
Product or component type	Solid state relay
Device short name	SSM1
Phase	1 phase

Complementary

Mounting support	Symmetrical DIN rail
Line Rated Current	20 A
Output voltage	24...280 V AC
[Uc] control circuit voltage	4...32 V DC
Contacts type and composition	1 NO
Tightening torque	Input : 0.6...0.7 N.m Output : 1.36...1.7 N.m
Connections - terminals	Screw terminals : 1 x 0.2...1 x 5.3 mm ² , (AWG 24...AWG 10) input Screw terminals : 1 x 0.2...1 x 5.3 mm ² , (AWG 24...AWG 10) output
Capacitance unbalance	<= 8 pF input/output
Insulation resistance	1000 MOhm at 500 V DC
Local signalling	LED green input status
Switching voltage	4 V DC turn-on 1 V DC turn-off
Input current limits	8...12 mA
Solid state output type	Zero voltage switching SCR output
Load current	0.15...20 A
Absolute maximum voltage	600 V
Surge current	<= 250 A for 16.6 ms
Voltage drop	1.6 V on-state
Maximum I ² t for fusing	260 A ² .s 8.3 ms
Leakage current	<= 10 mA off-state
DV/dt	500 V/μs off-state at maximum voltage
Response time	0.5 cycle turn-on 0.5 cycle turn-off
Overvoltage category	III
Product weight	0.62 lb(US) (0.28 kg)

Environment

dielectric strength	4 kV AC input/output 4 kV AC input or output to case
pollution degree	2
standards	UL 508 IEC 60950-1 CSA C22.2 No 14
product certifications	CSA UL EAC

The information provided in this documentation contains general descriptions and/or technical characteristics of the performance of the products contained herein. This documentation is not intended as a substitute for and is not to be used for determining suitability or reliability of these products for specific user applications. It is the duty of any such user or integrator to perform the appropriate and complete risk analysis, evaluation and testing of the products with respect to the relevant specific application or use thereof. Neither Schneider Electric Industries SAS nor any of its affiliates or subsidiaries shall be responsible or liable for misuse of the information contained herein.

marking	CE CSA UL EAC
IP degree of protection	IP20
ambient air temperature for operation	-40...176 °F (-40...80 °C)
ambient air temperature for storage	-40...257 °F (-40...125 °C)

Offer Sustainability

Green Premium product	Green Premium product
Compliant - since 1522 - Schneider Electric declaration of conformity	Compliant - since 1522 - Schneider Electric declaration of conformity
Reference not containing SVHC above the threshold	Reference not containing SVHC above the threshold
Available	Available
Available	Available

Dimensions

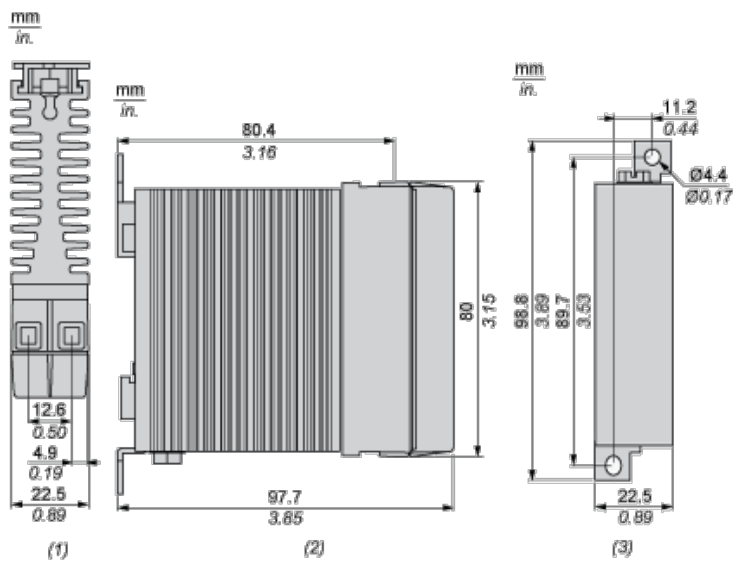

- (1) Top view
- (2) Side view
- (3) Front view

Derating Curves

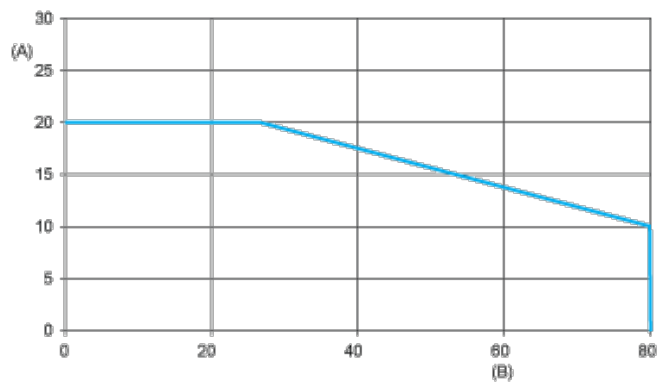

- A : Load Current (Amperes)
- B : Ambient Temperature (°C)