

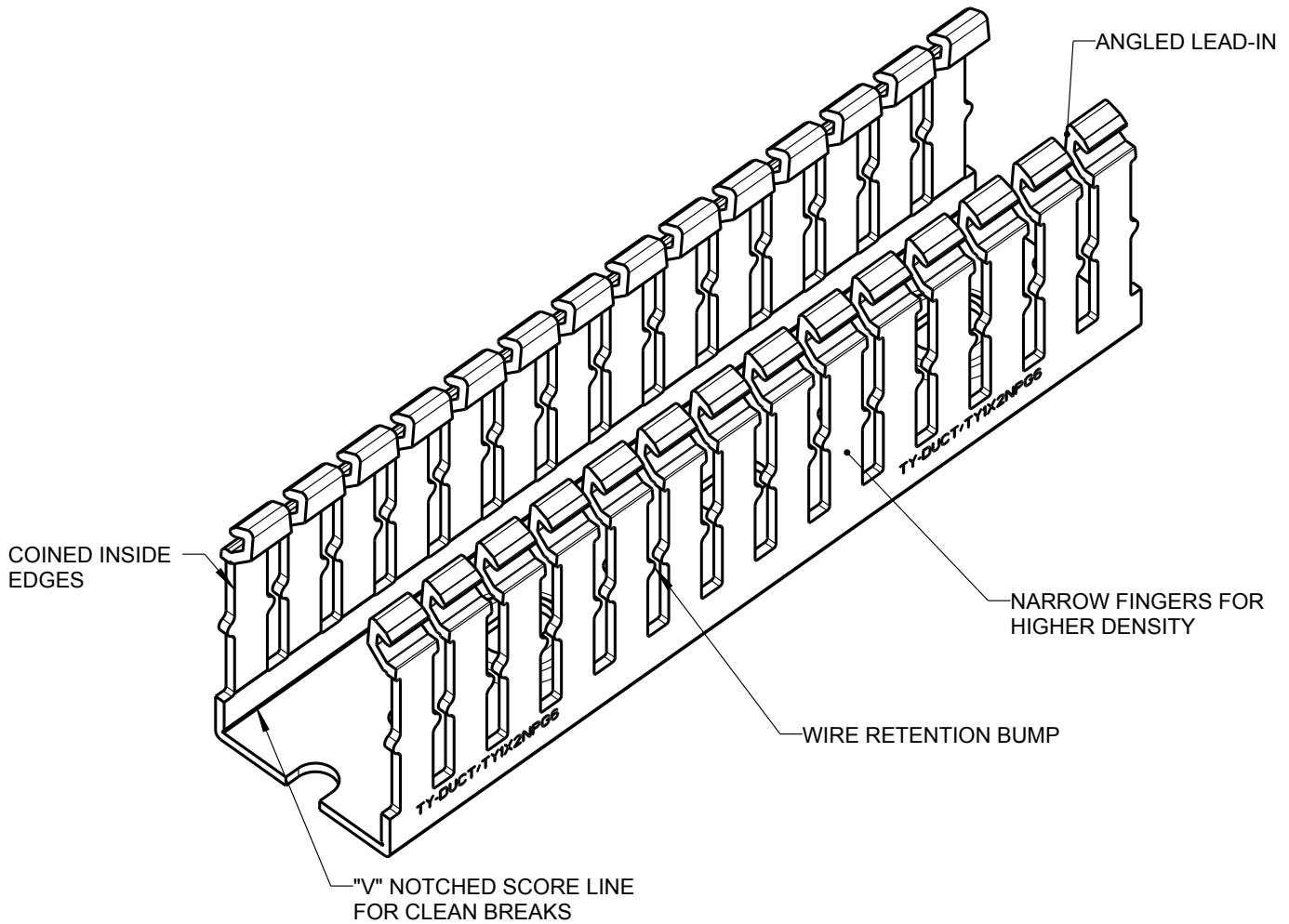



Ty-Duct®



NOTES:

1. MATERIAL: WEST LAKE CHEMICAL 5055 PVC, 100% REGRIND LEVEL
2. TEMPERATURE RATING: -40° F [-40° C] TO 140° F [60° C]
3. FLAMMABILITY RATING: UL94V-0
4. NORTH AMERICAN AND DIN STYLE MOUNTING HOLES
5. FLUSH MOUNT COVER DESIGN. COVER MOUNTS FLUSH WITH SIDE WALLS

GENERAL NOTES		 A Member of the ABB Group			
1. ALL DIMENSIONS ARE FOR REFERENCE ONLY. 2. DIMENSIONS IN BRACKETS [] ARE IN METRIC UNITS.					
REVISIONS		DESCRIPTION: NARROW SLOT WIRING DUCT			
-	SEE ERN **** FOR APPROVAL SIGNATURES & RELEASE DATE. PROJECT NO: ****	ORIGINAL PROJECT NO / (ERN NO) 104D000964 / (2017208)	SHEET NO: 1 OF 7	REV. NO: -	DRAWING NO: WSD-001622

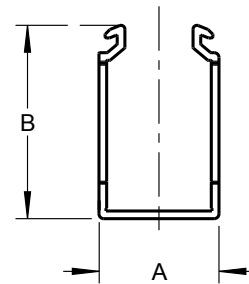
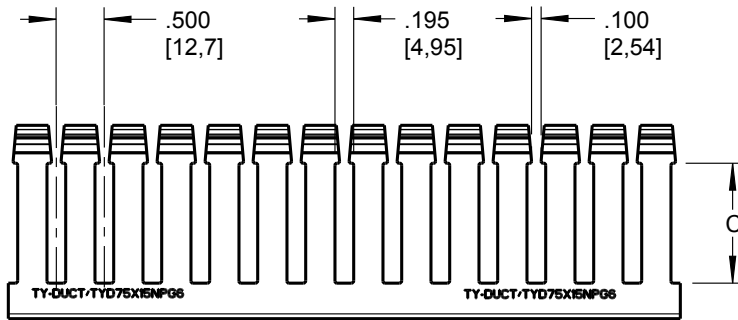
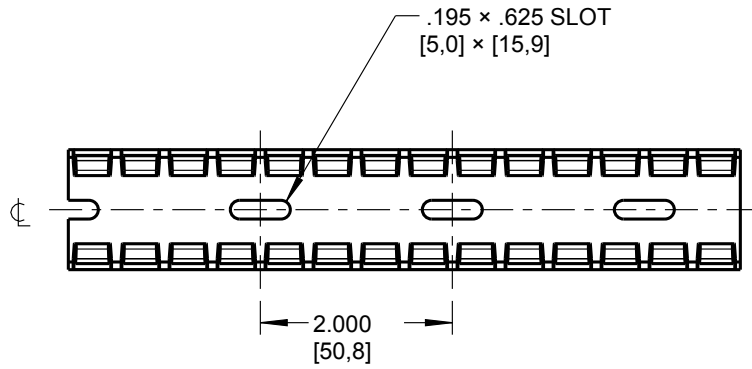

CATALOG NO.	A (WIDTH)	B (HEIGHT)	C	RETENTION FEATURE	COVER CATALOG NO.
TYD75X15NP*6	.940 [23,88]	1.500 [38,1]	.830 [21,08]	---	TY75CP*6
TYD1X1NP*6	1.250 [31,75]	1.025 [26,04]	.430 [10,92]	---	TY1CP*6
TYD1X15NP*6		1.500 [38,1]	.830 [21,08]	---	
TYD1X2NP*6		2.014 [51,16]	1.249 [31,72]	D	
TYD1X3NP*6		3.000 [76,2]	2.175 [55,25]	F	
TYD1X4NP*6		4.317 [109,65]	3.487 [88,57]	F	

* = COLOR CODE

B = BLACK G = GRAY I = INTRINSIC BLUE W = WHITE

Thomas & Betts
A Member of the ABB Group

www.tnb.com

DESCRIPTION: **NARROW SLOT WIRING DUCT**

SHEET NO: 2 OF 7	REV. NO: -	DRAWING NO: WSD-001622
---------------------	---------------	---------------------------

.195 × .625 SLOT
[5,0] × [15,9]

.315 × .551 SLOT
[8,0] × [14,0]

⌀

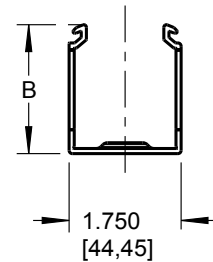
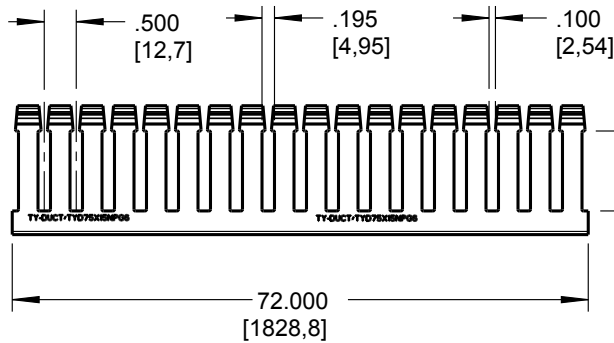
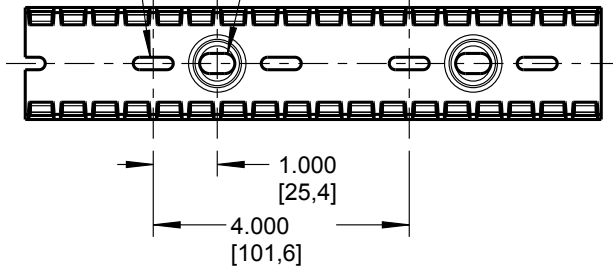

CATALOG NO.	B (HEIGHT)	C	RETENTION FEATURE	COVER CATALOG NO.
TYD15X1NP*6	1.025 [26,04]	.430 [10,92]	---	TY15CP*6
TYD15X15NP*6	1.500 [38,1]	.830 [21,08]	---	
TYD15X2NP*6	2.014 [51,16]	1.249 [31,72]	D	
TYD15X3NP*6	3.000 [76,2]	2.175 [55,25]	F	
TYD15X4NP*6	4.317 [109,65]	3.487 [88,57]	F	

* = COLOR CODE

B = BLACK G = GRAY I = INTRINSIC BLUE W = WHITE

Thomas & Betts A Member of the ABB Group		
www.tnb.com		
DESCRIPTION: NARROW SLOT WIRING DUCT		
SHEET NO: 3 OF 7	REV. NO: -	DRAWING NO: WSD-001622

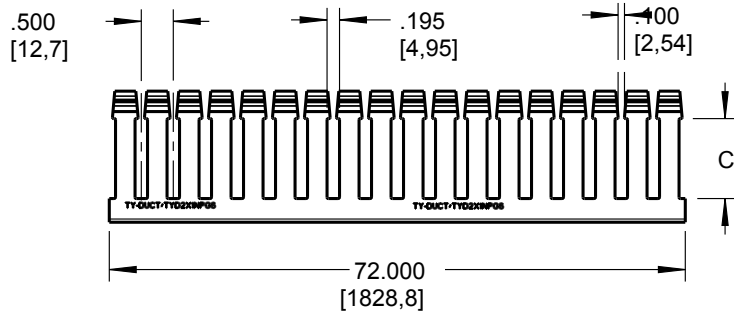
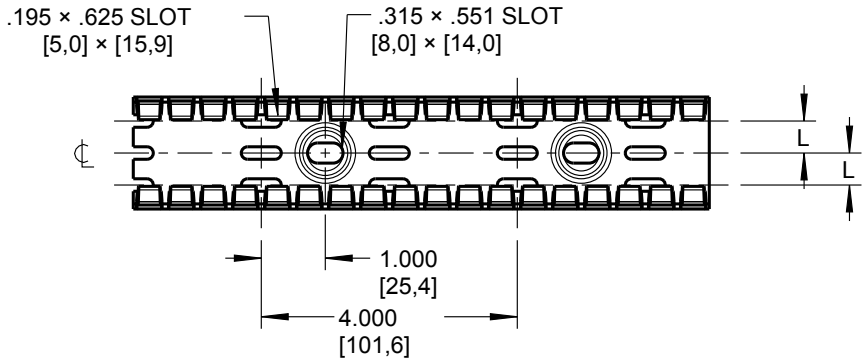

CATALOG NO.	A (WIDTH)	B (HEIGHT)	C	L	RETENTION FEATURE	COVER CATALOG NO.
TYD2X1NP*6	2.250 [57,15]	1.046 [26,57]	.430 [10,92]	0.500 [12,7]	---	TY2CP*6
TYD2X15NP*6		1.521 [38,63]	.830 [21,08]		---	
TYD2X2NP*6		2.034 [51,66]	1.249 [31,72]		D	
TYD2X3NP*6		3.000 [76,2]	2.175 [55,25]		F	
TYD2X4NP*6		4.332 [110,03]	3.487 [88,57]		F	
TYD2X5NP*6		5.020 [127,51]	4.161 [105,69]		F	
TYD25X2NP*6	2.750 [69,85]	2.034 [51,66]	1.249 [31,72]	0.750 [19,05]	D	TY25CP*6
TYD25X3NP*6		3.000 [76,2]	2.175 [55,25]		F	
TYD25X4NP*6		4.332 [110,03]	3.487 [88,57]		F	

* = COLOR CODE

B = BLACK G = GRAY I = INTRINSIC BLUE W = WHITE

Thomas & Betts
A Member of the ABB Group

www.tnb.com

DESCRIPTION: **NARROW SLOT WIRING DUCT**

SHEET NO: 4 OF 7	REV. NO: -	DRAWING NO: WSD-001622
---------------------	---------------	----------------------------------

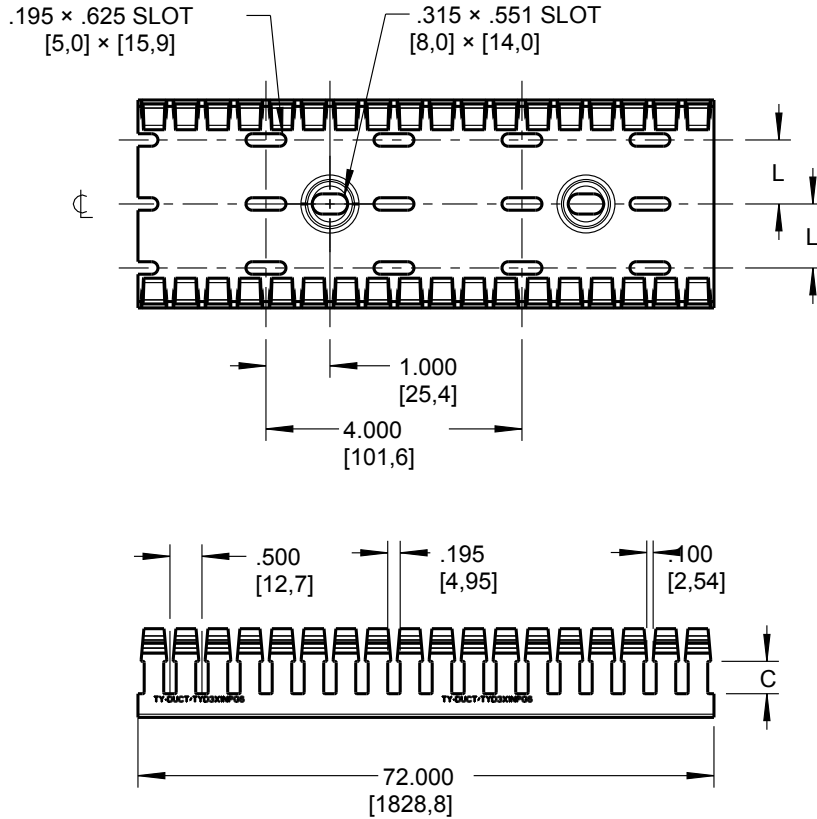

CATALOG NO.	A (WIDTH)	B (HEIGHT)	C	L	RETENTION FEATURE	COVER CATALOG NO.
TYD3X1NP*6	3.250 [82,55]	1.055 [26,8]	.430 [10,92]	1.000 [25,4]	---	TY3CP*6
TYD3X2NP*6		2.081 [52,86]	1.249 [31,72]		D	
TYD3X3NP*6		3.056 [77,62]	2.175 [55,25]		F	
TYD3X4NP*6		4.387 [111,43]	3.487 [88,57]		F	
TYD3X5NP*6		5.061 [128,55]	4.161 [105,69]		F	
TYD4X2NP*6	4.250 [107,95]	2.081 [52,86]	1.249 [31,72]	1.500 [38,1]	---	TY4CP*6
TYD4X3NP*6		3.056 [77,62]	2.175 [55,25]		D	
TYD4X4NP*6		4.387 [111,43]	4.161 [105,69]		F	
TYD4X5NP*6		5.061 [128,55]	3.487 [88,57]		F	
TYD6X4NP*6	6.250 [158,75]	4.387 [111,43]	3.987 [101,27]	2.500 [63,5]	F	TY6CP*6

* = COLOR CODE

B = BLACK G = GRAY I = INTRINSIC BLUE W = WHITE

Thomas & Betts
A Member of the ABB Group

www.tnb.com

DESCRIPTION: **NARROW SLOT WIRING DUCT**

SHEET NO: 5 OF 7	REV. NO: -	DRAWING NO: WSD-001622
---------------------	---------------	----------------------------------

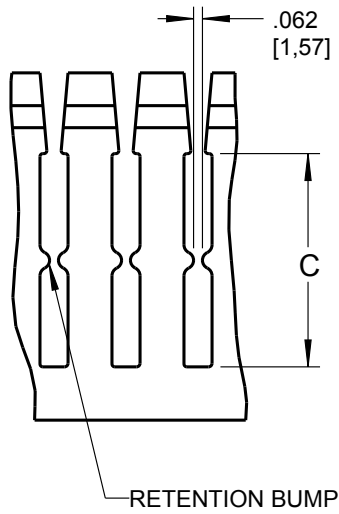

FIG. D

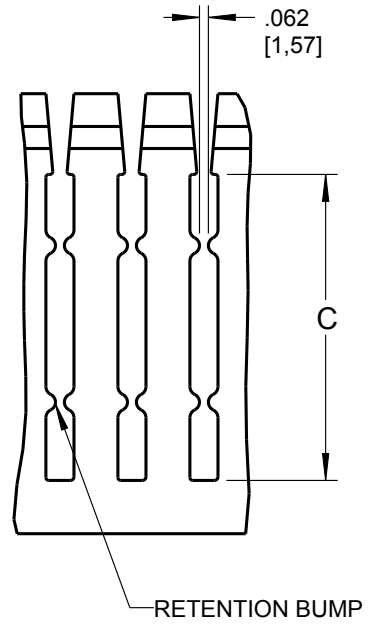



FIG. F

 A Member of the ABB Group		
www.tnb.com		
DESCRIPTION: NARROW SLOT WIRING DUCT		
	SHEET NO: 6 OF 7	REV. NO: -
DRAWING NO: WSD-001622		

NOMINAL DUCT SIZE W H	AREA SQUARE	ELECTRICAL												DATA CABLE							
		8 AWG		10 AWG		12 AWG		14 AWG		16 AWG		18 AWG		22 AWG		24 AWG					
		Ø.216	THHN	Ø.153	THHN	Ø.122	THHN	Ø.105	THHN	Ø.096	THHN	Ø.125	THHN	Ø.113	THHN	Ø.065	MTW	Ø.217	UTP/CM CAT5E	Ø.250	UTP/CM CAT6
1.00 x 1.00	1.000	6	12	19	11	26	15	10	31	18	40	22	68	6	5	2					
1.00 x 2.00	2.000	12	24	38	23	52	30	21	62	37	81	45	135	12	9	3					
1.00 x 3.00	3.000	18	37	58	34	78	44	31	93	55	121	67	203	18	14	5					
1.00 x 4.00	4.000	24	49	77	46	104	59	42	124	73	162	90	270	24	18	6					
1.50 x 1.00	1.500	9	18	29	17	39	22	16	47	27	61	34	101	9	7	2					
1.50 x 1.50	2.250	14	27	43	26	58	33	24	70	41	91	50	152	14	10	4					
1.50 x 2.00	3.000	18	37	58	34	78	44	31	93	55	121	67	203	18	14	5					
1.50 x 3.00	4.500	28	55	86	52	117	67	47	140	82	182	101	304	27	21	7					
1.50 x 4.00	6.000	37	73	115	69	155	89	63	186	110	243	134	406	36	27	10					
2.00 x 1.00	2.000	12	24	38	23	52	30	21	62	37	81	45	135	12	9	3					
2.00 x 1.50	3.000	18	37	58	34	78	44	31	93	55	121	67	203	18	14	5					
2.00 x 2.00	4.000	24	49	77	46	104	59	42	124	73	162	90	270	24	18	6					
2.00 x 3.00	6.000	37	73	115	69	155	89	63	186	110	243	134	406	36	27	10					
2.00 x 4.00	8.000	49	98	154	92	207	118	84	248	146	324	179	541	49	37	13					
2.00 x 5.00	10.000	61	122	192	114	259	148	105	310	183	405	224	676	61	46	16					
2.50 x 2.00	5.000	31	61	96	57	130	74	52	155	91	202	112	338	30	23	8					
2.50 x 3.00	7.500	46	92	144	86	194	111	79	233	137	304	168	507	46	34	12					
2.50 x 4.00	10.000	61	122	192	114	259	148	105	310	183	405	224	676	61	46	16					
3.00 x 1.00	3.000	18	37	58	34	78	44	31	93	55	121	67	203	18	14	5					
3.00 x 2.00	6.000	37	73	115	69	155	89	63	186	110	243	134	406	36	27	10					
3.00 x 3.00	9.000	55	110	173	103	233	133	94	279	165	364	201	609	55	41	14					
3.00 x 4.00	12.000	73	146	230	137	311	177	126	372	219	486	269	811	73	55	19					
4.00 x 4.00	16.000	98	195	307	183	415	237	168	496	293	648	358	1082	97	73	26					
4.00 x 5.00	20.000	122	244	384	229	518	296	210	620	366	810	448	1352	121	91	32					
6.00 x 4.00	24.000	144	293	461	275	622	355	252	744	439	972	537	1623	146	110	39					

NOTE: WIRE FILL IS BASED ON 50% FILL OF DUCT AREA

www.tnb.com



DESCRIPTION: **NARROW SLOT WIRING DUCT**

SHEET NO:
7 OF 7

REV. NO:
-

DRAWING NO:
WSD-001622