

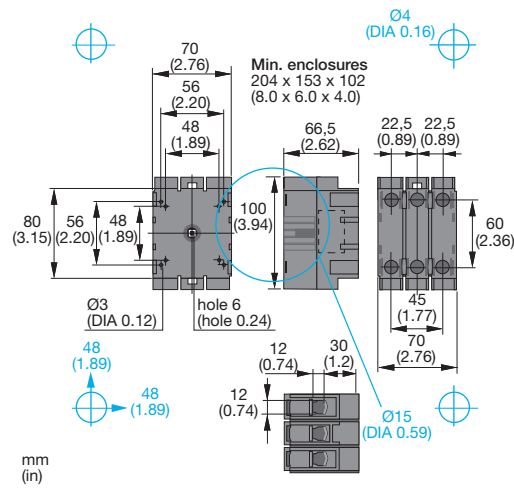

mm  
(in)

Prepared	2017-06-29 H Hakko	Checked		Title	Packing box	Language	
	EYLZKO277-RA						
					194U-IN002A-EN E		
				Document No.	10002562267 - VER 01	Sheet	1/4



Prepared	2017-06-29 H Hakko	Checked		Title	Packing box	Language	
	EYLZKO277-RA						
 <b>Allen-Bradley</b> • Rockwell Software 					194U-IN002A-EN E		
				Document No.	10002562267 - VER 01	Sheet	2/4

<b>194U-E30-1753</b> <b>194U-E60-1753</b> 2,5...25 mm <sup>2</sup> 14...4 AWG	<b>194U-E100-1753</b> 10...70 mm <sup>2</sup> 8...1/0 AWG
--	---

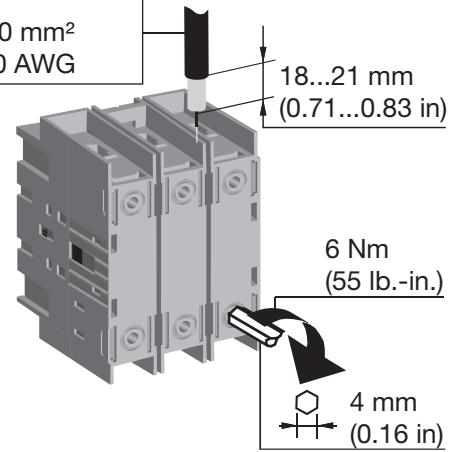
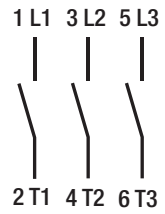

Prepared	2017-06-29 H Hakko	Checked		Title	Packing box	Language	
	EYLZKO277-RA						
<b>Allen-Bradley</b> • Rockwell Software <b>Rockwell Automation</b>					194U-IN002A-EN E		
				Document No.	10002562267 - VER 01	Sheet	3/4



**WARNING:** To prevent electrical shock, disconnect from power source before installing or servicing. Install in suitable enclosure. Keep free from contaminants.

**WARNUNG:** Vor Installations- oder Servicearbeiten Stromversorgung unterbrechen, um Unfälle zu vermeiden. Die Geräte müssen in einem passenden Gehäus, und gegen Verschmutzung geschützt werden.



**AVERTISSEMENT:** Avant le montage et la mise en service, couper l'alimentation secteur afin d'éviter tout accident. Prévoit une mise en coffret ou armoire. Protéger le produit contre les environnements agressifs.

**AVVERTENZA:** Per prevenire infortuni, togliere tensione prima dell'installazione o manutenzione. Installare in custodia idonea. Tenere lontano da contaminanti.

**ADVERTENCIA:** Desconectar la alimentación eléctrica antes de realizar el montaje y la puesta en servicio, con el objeto de evitar accidentes. Instalarlo en un apropiado. Proteger el producto de los ambientes agresivos.

**ПРЕДУПРЕЖДЕНИЕ:** Во избежание поражения электрическим током, отсоединить от источника питания перед установкой или обслуживанием. Устанавливать в соответствующем корпусе. Предхранять от загрязнений.

警告：为了防止触电，在安装或维修之前必须先切断电源。安装在合适的设备箱内，防止接触污染物。

Prepared	2017-06-29 H Hakko	Checked		Title	Packing box	Language	
	EYLZKO277-RA						
 <b>Allen-Bradley</b> • Rockwell Software 					194U-IN002A-EN E		
				Document No.	10002562267 - VER 01	Sheet	4/4