

Section 7

Miniature and Molded Case Circuit Breakers

| | |
|---|------|
| Selection Information | 7-1 |
| QO™ and QOU Miniature Circuit Breakers | 7-11 |
| Homeline™ Miniature Circuit Breakers | 7-21 |
| Multi9™ Miniature Circuit Breakers | 7-24 |
| PowerPacT™ Molded Case Circuit Breakers | 7-30 |
| Mission Critical Circuit Breakers | 7-46 |
| 500 Vdc Circuit Breakers | 7-47 |
| Automatic Switches | 7-48 |
| Motor Circuit Protectors | 7-49 |
| PowerPacT™ Circuit Breaker Accessories | 7-55 |
| MicroLogic™ Electronic Trip Units | 7-65 |
| MasterPacT™ Power Circuit Breakers | 7-70 |
| Enerlin'X Digital Solutions | 7-79 |
| Ground-Fault Protection | 7-84 |
| Dimensions and Shipping Weights | 7-85 |
| Circuit Breaker Enclosures | 7-87 |



B-Frame



H-Frame



J-Frame



L-Frame



M-Frame



P-Frame



R-Frame

QO Miniature Circuit Breakers

| QO™ Circuit Breakers | | | | | | | | | | | | | | | | | | |
|-------------------------------------|-----------------|--------------|--------|----------|-------|--------|--------|--------|----------|--------|-----------|---------------|----------|----------|----------|----------|-----------|----|
| | | | | | | | | | | | | | | | | | | |
| Circuit Breaker Type | Plug-on | QO | | | QO-H | | | QO-VH | | | QH | | QOT | QO-AF | QO-VHAF | QO-AFGF | QOVH-AFGF | |
| | Bolt-on | QOB | | | QOB-H | | | QOB-VH | | | QHB | | — | QOB-CAFI | QOB-VHAF | QOB-DF | QOB-VHDF | |
| | Unit Mount | — | | | — | | | — | | | — | | — | — | | — | | |
| Number of Poles | 1 | 2 | 3 | 2 | 1 | 2 | 3 | 1 | 2, 3 [1] | 1, 2 | 3 | 1 | 1, 2 | 1, 2 | 1 | 1 | 1 | |
| Current Range (A) | 10–70 | 10–200 [2] | 10–100 | 15–100 | 15–70 | 15–125 | 15–100 | 15–70 | 15–150 | 15–30 | 15–30 | 15–30 | 15–20 | 15–20 | 15–20 | 15–20 | 15–20 | |
| Interrupting Ratings | | | | | | | | | | | | | | | | | | |
| UL/CSA Rating (kA) (50/60 Hz) | 120 Vac | 10 | 10 | 10 | 10 | 22 | 22 | 22 | 22 | 22 | 22 | 65 | 65 | 10 | 10 | 22 | 10 | 22 |
| | 120/240 Vac | 10 | 10 | 10 | 10 | 22 | 22 | 22 | 22 | 22 | 22 | 65 | 65 | 10 | 10 | 22 | — | — |
| | 208Y/120 | — | — | — | — | — | — | — | — | — | — | — | — | — | — | — | — | — |
| | 240 Vac [3] | — | — | 10 | 10 | — | — | 22 | — | 22 [4] | — | 65 | — | — | — | — | — | — |
| | 277 Vac | — | — | — | — | — | — | — | — | — | — | — | — | — | — | — | — | — |
| DC Ratings | 480Y/277 Vac | — | — | — | — | — | — | — | — | — | — | — | — | — | — | — | — | — |
| | 48 Vdc | — | 5 [5] | — | — | — | — | — | — | — | — | — | — | — | — | — | — | — |
| | 60 Vdc | — | — | — | — | — | — | — | — | — | — | — | — | — | — | — | — | — |
| | 65 Vdc | — | — | — | — | — | — | — | — | — | — | — | — | — | — | — | — | — |
| | 125 Vdc | — | — | — | — | — | — | — | — | — | — | — | — | — | — | — | — | — |
| IEC 60947-2 (50/60 Hz) [6] | 250 Vdc | — | — | — | — | — | — | — | — | — | — | — | — | — | — | — | — | — |
| | 500 Vdc | — | — | — | — | — | — | — | — | — | — | — | — | — | — | — | — | — |
| IEC (Icu) | — | — | — | — | — | — | — | — | — | — | — | — | — | — | — | — | — | — |
| Special Ratings | | | | | | | | | | | | | | | | | | |
| CCC | — | — | — | — | — | — | — | — | — | — | — | — | — | — | — | — | — | — |
| Fed. Specs W-C-375B/GEN | X | — | — | — | X | — | — | — | — | — | X | — | X | — | — | X | X | |
| Other Standard | HACR [7] NOM | | | HACR [7] | | | | | | — | — | — | HACR [7] | — | HACR [7] | HACR [7] | | |
| Accessories and Modifications | | | | | | | | | | | | | | | | | | |
| Shunt Trip [8] | X | X | X | X | X | X | X | X | X | X [9] | X | X | X | — | — | — | — | |
| Undervoltage Trip | — | — | — | — | — | — | — | — | — | — | — | — | — | — | — | — | — | |
| Auxiliary Switches [8] | X | X | X | X | X | X | X | X | X | X [9] | X | X | X | — | X | — | — | |
| Alarm Switch [8] | X | X | X | X | X | X | X | X | X | X [9] | X | X | X | — | X | — | — | |
| Handle Operators | — | — | — | — | — | — | — | — | — | — | — | — | — | — | — | — | — | |
| Handle Padlock Attachment | X | X | X | X | X | X | X | X | X | X | X | X | X | X | X | X | X | |
| Trip System Type | | | | | | | | | | | | | | | | | | |
| Thermal-magnetic | X | X | X | X | X | X | X | X | X | X | X | X | X | X | X | X | X | |
| Molded Case Switch | X | X | X | — | — | — | — | — | — | — | — | — | — | — | — | — | — | |
| Dimensions (1P Unit Mount) | | | | | | | | | | | | | | | | | | |
| Dimensions (1P Unit Mount) in. (mm) | Height | 3.5 (89) [1] | | | | | | | | | | 4.75 (121) | | | | | | |
| | Width | — | | | | | | | | | | 0.75 (19) [1] | | | | | | |
| | Depth | — | | | | | | | | | | 2.92 (74) [1] | | | | | | |
| Pages | — | | | | | | | | | | page 7-11 | | | | | | | |

[1] For dimensions for QOB2150VH, QOB3110VH, QOB3125VH and QOB3150VH, see page 7-85

[2] 2P 150–200 A requires 4P width.

[3] See the Supplemental Digest, Section 3 for 3Ø corner grounded systems.

[4] 22 kA @ 240 Vac for 3P only.

[5] 2P, 10–60 A only, suffix 5272.



[6] See the Supplemental Digest Section 10 for circuit breakers with IEC ratings.

[7] HACR on QO, QOB 1P 10–70 A, 2P 15–100 A, 3P 10–100 A; QOB-VH 1P 15–70 A, 2P 15–125 A, 3P 15–100 A.

[8] Factory-installed option only.

[9] Factory-installed accessories are not available on QOB-VH 2P150 A and 3P 110–150 A.

QO-GFI, QO-EPD, QOU, QOM Miniature Circuit Breakers

| | | QO Circuit Breakers | | | | | | QOU Circuit Breakers | | | QOM1 and QOM2 Main Circuit Breakers | | |
|---|--------------|---|-------|-------|-----------|--------------------|-----------|---|--------|---------------|---|-----------------|----|
| | |  | | | | | |  | | |  | | |
| Circuit Breaker Type | Plug-on | QO-GFI | | | QO-VHGF1 | QO-EPD QO-EPE | | — | | | — | — | |
| | Bolt-on | QOB-GFI | | | QOB-VHGF1 | QOB-EPD QOB-EPE | | — | | | QOM1-VH | QOM2-VH | |
| | Unit Mount | — | — | — | — | — | — | QOU | | | — | — | |
| Number of Poles | 1 | 2 | 3 | 1 | 1 | 2 | 3 | 1 | 2 | 3 | 2 | 2 | |
| Current Range (A) | 15-30 | 15-60 | 15-50 | 15-30 | 15-30 | 15-60 | 15-50 | 10-100 | 10-125 | 10-100 | 50-125 | 100-225 | |
| Interrupting Ratings | | | | | | | | | | | | | |
| UL/CSA Rating (kA RMS) (50/60 Hz) | 120 Vac | 10 | 10 | — | 22 | 10 | 10 | — | 10 | 10 | 10 | 22 | 22 |
| | 120/240 Vac | — | 10 | — | — | — | 10 | — | 10 | 10 | 10 | 22 | 22 |
| | 208Y/120 | — | — | 10 | — | — | — | — | — | — | — | — | — |
| | 240 Vac [10] | — | — | — | — | — | — | 10 | — | — | 10 | — | — |
| | 277 Vac | — | — | — | — | — | — | — | — | — | — | — | — |
| DC Ratings | 480Y/277 Vac | — | — | — | — | — | — | — | — | — | — | — | — |
| | 48 Vdc | — | — | — | — | — | — | — | — | — | — | — | — |
| | 60 Vdc | — | — | — | — | — | — | — | 5 [11] | 5 [11] | 5 [11] | — | — |
| | 65 Vdc | — | — | — | — | — | — | — | — | — | — | — | — |
| | 125 Vdc | — | — | — | — | — | — | — | — | — | — | — | — |
| | 250 Vdc | — | — | — | — | — | — | — | — | — | — | — | — |
| IEC 60947-2 (50/60 Hz) Icu | 500 Vdc | — | — | — | — | — | — | — | — | — | — | — | — |
| | 240 Vac | — | — | — | — | — | — | — | — | — | — | — | — |
| | 415 Vac | — | — | — | — | — | — | — | — | — | — | — | — |
| Special Ratings | | | | | | | | | | | | | |
| CCC | — | — | — | — | — | — | — | X [12] | X [12] | X [12] | — | — | |
| Fed. Specs W-C-375B/GEN | X | — | — | — | X | — | — | X | X | X | X | X | |
| Other Standard | NOM | | | — | NOM | | — | HACR [13] | | | — | — | |
| Accessories and Modifications | | | | | | | | | | | | | |
| Shunt Trip | — | — | — | — | — | — | — | X [14] | X [14] | X [14] | — | X [14] | |
| Undervoltage Trip | — | — | — | — | — | — | — | — | — | — | — | — | |
| Auxiliary Switches | X | X | X | X | X | X | X | X [14] | X [14] | X [14] | — | — | |
| Alarm Switch | X | X | X | X | X | X | X | X [14] | X [14] | X [14] | — | — | |
| Handle Operators | — | — | — | — | — | — | — | — | — | — | — | — | |
| Handle Padlock Attachment | X | X | X | X | X | X | X | X | X | X | X | X | |
| Trip System Type | | | | | | | | | | | | | |
| Thermal-magnetic | X | X | X | X | X | X | X | X | X | X | X | X | |
| Molded Case Switch | — | — | — | — | — | — | — | — | X | X | — | — | |
| Dimensions (1P Unit Mount) | | | | | | | | | | | | | |
| Dimensions (1P Unit Mount) in. (mm) | Height | 4.12 (103) | | | | | | 4.05 (103) | | | 5.09 (129) [15] | 5.60 (142) [15] | |
| | Width | 0.75 (19) | | | | | | 0.75 (19) | | | 5.00 (127) [15] | 5.07 (129) [15] | |
| | Depth | 2.92 (74) | | | | | | 2.92 (74) | | | 3.47 (88) [15] | 3.60 (91) [15] | |
| Pages | page 7-11 | | | | | | page 7-18 | | | See Section 1 | | | |

NOTE: All circuit breakers on this chart are UL Listed and CSA Certified unless otherwise noted.

[10] For information regarding 3Ø corner grounded systems see the Supplemental Digest, Section 3.
 [11] QOU is UL Listed for 60 Vdc per pole 80-100 A, 1P; 80-125 A, 2P; and 70-100 A, 3P.
 [12] 15-70 A 1P and 2P, 15-60 A 3P
 [13] HACR on QOU 1P and 3P 15-100 A, 2P 15-125 A;
 [14] Factory-installed option only.
 [15] QOM1 and QOM2 dimensions are for 2-pole unit.

HOM Circuit Breakers

| HOM Circuit Breakers | | | | | | | | | | | |
|-------------------------------------|--------------|---------------|-------------|----------|-----------|---------|-----------|-------|-------|------------|--|
| | | | | | | | | | | | |
| Circuit Breaker Type | Plug-on | | HOM | HOM-CAFI | HOM-DF | HOM-GFI | HOM-EPD | HOMT | | | |
| | Bolt-on | — | — | — | — | — | — | — | — | — | |
| | Unit Mount | — | — | — | — | — | — | — | — | — | |
| Number of Poles | | 1 | 2 | 1, 2 | 1 | 1 | 2 | 1 | 2 | 1 | |
| Current Range (A) | | 15–50 | 15–200 [16] | 15–20 | 15–20 | 15–20 | 15–50 | 15–20 | 15–50 | 15–50 [17] | |
| Interrupting Ratings | | | | | | | | | | | |
| UL/CSA Rating (kA) (50/60 Hz) | 120 Vac | 10 | 10 | 10 | 10 | 10 | 10 | 10 | 10 | 10 | |
| | 120/240 Vac | 10 | 10 | 10 | — | — | 10 | — | 10 | 10 | |
| | 208Y/120 | — | — | — | — | — | — | — | — | — | |
| | 240 Vac [18] | — | — | — | — | — | — | — | — | — | |
| | 277 Vac | — | — | — | — | — | — | — | — | — | |
| DC Ratings | 480Y/277 Vac | — | — | — | — | — | — | — | — | — | |
| | 48 Vdc | — | — | — | — | — | — | — | — | — | |
| | 60 Vdc | — | — | — | — | — | — | — | — | — | |
| | 65 Vdc | — | — | — | — | — | — | — | — | — | |
| | 125 Vdc | — | — | — | — | — | — | — | — | — | |
| IEC 60947-2 (50/60 Hz) [19] | 250 Vdc | — | — | — | — | — | — | — | — | — | |
| | IEC (Icu) | — | — | — | — | — | — | — | — | — | |
| Special Ratings | | | | | | | | | | | |
| CCC | | — | — | — | — | — | — | — | — | — | |
| Fed. Specs W-C-375B/GEN | | X | X | X | X | X | X | X | X | X | |
| Other Standard | | HACR [20] NOM | | | HACR [20] | | | | | | |
| Accessories and Modifications | | | | | | | | | | | |
| Shunt Trip [21] | | — | — | — | — | — | — | — | — | — | |
| Undervoltage Trip | | — | — | — | — | — | — | — | — | — | |
| Auxiliary Switches [21] | | — | — | — | — | — | — | — | — | — | |
| Alarm Switch [21] | | — | — | — | — | — | — | — | — | — | |
| Handle Operators | | — | — | — | — | — | — | — | — | — | |
| Handle Padlock Attachment | | X | X | X | X | — | — | — | — | X [22] | |
| Trip System Type | | | | | | | | | | | |
| Thermal-magnetic | | X | X | X | X | X | X | X | X | X | |
| Molded Case Switch | | — | — | — | — | — | — | — | — | — | |
| Dimensions (1P Unit Mount) | | | | | | | | | | | |
| Dimensions (1P Unit Mount) in. (mm) | Height | | | | | | 3.13 (79) | | | | |
| | Width | | | | | | 1.00 (25) | | | | |
| | Depth | | | | | | 2.98 (76) | | | | |
| Pages | | | | | | | page 7-21 | | | | |

[16] 2P 150–200 A requires 4P width.
 [17] HOMT tandem is 30 A maximum. HOMT quad tandem has 20 A maximum on outside poles, and 50 A maximum on the inside poles.
 [18] See the Supplemental Digest, Section 3 for 3Ø corner grounded systems.
 [19] See the Supplemental Digest Section 10 for circuit breakers with IEC ratings.
 [20] HACR on HOM 1P 15–50 A and 2P 15–100 A.
 [21] Factory-installed option only.
 [22] Handle padlock attachment available for HOMT quad tandem only.

Multi9™, EDB Miniature Circuit Breakers

| | | Multi9™ Circuit Breakers and Supplementary Protectors | | | | | | EDB Circuit Breakers | | | | | | | |
|--------------------------------------|--------------|---|---------|-------------------|-----------|---------|---------|----------------------|-----------|--------|------------|--------|--------|--------|--------|
| | | | | | | | | | | | | | | | |
| Circuit Breaker Type | Plug-on | — | | | | | | — | | | | | | | |
| | Bolt-on | — | | | | | | — | | | | | | | |
| | Unit Mount | UL 489 C60BP | | UL1077 C60SP [23] | | C60H-DC | | EDB | | EGB | | EJB | | | |
| Number of Poles | 1 | 2 | 3 | 1 | 2 | 3,4 | 1 | 2 | 1 | 2,3 | 1 | 2,3 | 1 | 2,3 | |
| Current Range (A) | 0.5–63 | 0.5–63 | 0.5–63 | 0.5–63 | 1–63 | 1–63 | 0.5–63 | 0.5–63 | 15–70 | 15–125 | 15–70 | 15–125 | 15–70 | 15–125 | |
| Interrupting Ratings | | | | | | | | | | | | | | | |
| UL/CSA Rating (kA RMS) (50/60 Hz) | 120 Vac | 14 [24] | 14 [24] | 14 [24] | 14 [25] | 14 [25] | 14 [25] | — | — | 25 | 25 | 65 | 65 | 100 | 100 |
| | 120/240 Vac | 14 [24] | 14 [24] | 14 [24] | 14 [25] | 14 [25] | 14 [25] | — | — | 18 | 25 | 35 | 65 | 65 | 100 |
| | 240 Vac [26] | 14 [24] | 14 [24] | 14 [24] | 14 [25] | 14 [25] | 14 [25] | — | — | 18 | 25 | 35 | 65 | 65 | 100 |
| | 277 Vac | — | — | — | 10 [27] | 10 [27] | 10 [27] | — | — | 18 | 18 | 35 | 35 | 65 | 65 |
| DC Ratings | 480Y/277 Vac | 10 [28] | 10 [29] | 10 [29] | — | 10 [27] | 10 [27] | — | — | — | 18 | — | 35 | — | 65 |
| | 48 Vdc | — | — | — | — | 10 | — | — | 5 | 5 | — | — | — | — | — |
| | 60 Vdc | 10 | 10 | — | 20 | — | — | — | 5 | 5 | — | — | — | — | — |
| | 65 Vdc | — | — | — | — | — | — | — | 5 | 5 | — | — | — | — | — |
| | 125 Vdc | — | 10 | — | — | — | — | — | 5 | 5 | — | — | — | — | — |
| | 250 Vdc | — | — | — | — | — | — | — | 5 | 5 | — | — | — | — | — |
| IEC 60947-2 (50/60 Hz) Icu | 240 Vac | 10 | 20 | 20 | 10 | 20 | 20 | — | — | 20 | — | — | — | — | — |
| | 415 Vac | — | 10 | 10 | — | 5 | 5 | — | — | 10 | — | — | — | — | — |
| Special Ratings | | | | | | | | | | | | | | | |
| CCC | | X | X | X | X | X | X | X | X | — | — | — | — | — | — |
| Other Standard | | IEC | | | | | | HACR | | | | | | | |
| Accessories and Modifications | | | | | | | | | | | | | | | |
| Shunt Trip | | X | X | X | X | X | X | X | X | X [31] | X [31] | X [31] | X [31] | X [31] | X [31] |
| Undervoltage Trip | | X | X | X | X | X | X | X | X | — | — | — | — | — | — |
| Auxiliary Switches | | X | X | X | X | X | X | X | X | X [31] | X [31] | X [31] | X [31] | X [31] | X [31] |
| Alarm Switch | | X | X | X | X | X | X | X | X | X [31] | X [31] | X [31] | X [31] | X [31] | X [31] |
| Handle Operators | | X | X | X | X | X | X | X | X | — | — | — | — | — | — |
| Handle Padlock Attachment | | X | X | X | X | X | X | X | X | X | X | X | X | X | X |
| Trip System Type | | | | | | | | | | | | | | | |
| Thermal-magnetic | | X | X | X | X | X | X | X | X | X | X | X | X | X | X |
| Molded Case Switch | | — | — | — | — | — | — | — | — | — | — | — | — | — | — |
| Dimensions (1P Unit Mount) | | | | | | | | | | | | | | | |
| Dimensions (1P Unit Mount) in. (mm) | Height | 4.05 (103) | | | 3.19 (81) | | | 3.19 (81) | | | 5.66 (144) | | | | |
| | Width | 0.71 (18) | | | 0.71 (18) | | | 0.71 (18) | 1.42 (36) | | 0.98 (25) | | | | |
| | Depth | 2.76 (70) | | | 2.76 (70) | | | 2.56 (65) | | | 4.05 (103) | | | | |
| Pages | | page 7-24 | | | | | | See Section 9 | | | | | | | |

NOTE: All circuit breakers on this chart are UL Listed and CSA Certified unless otherwise noted.

[23] C60 are recognized components per UL 1077.
 [24] 14 kA up to 35 A, 10 kA from 40 to 63 A.
 [25] 14 kA up to 32 A, 10 kA from 40 to 63 A.
 [26] For information regarding 3Ø corner grounded systems see the Supplemental Digest, Section 3.
 [27] 10 kA up to 32 A, 5 kA from 40 to 63 A.
 [28] Up to 35 A.
 [29] 10 kA up to 35 A.
 [30] 2 poles must be wired in series for 500 Vdc.
 [31] Factory-installed option only.



B-, H-, J-Frame Molded Case Circuit Breakers

| | | PowerPacT™ 125 A B-Frame | | | | PowerPacT 150 A H-Frame | | | | | PowerPacT 250 A J-Frame | | | | |
|--|--------------|--------------------------|------------|------------|-------|-------------------------|--------|-----------|-----------|--------|-------------------------|-------------|-------------|-------------|-------------|
| | | | | | | Electronic Trip Version | | | | | Electronic Trip Version | | | | |
| | | | | | | | | | | | | | | | |
| Circuit Breaker Type | | BD | BG | BJ | BK | HD | HG | HJ | HL | HR | JD | JG | JJ | JL | JR |
| Number of Poles | | 1, 2, 3, 4 | 1, 2, 3, 4 | 1, 2, 3, 4 | 1, 2 | 2, 3 | 2, 3 | 2, 3 [32] | 2, 3 [32] | 3 | 2, 3 [32] | 2, 3 [32] | 2, 3 [32] | 2, 3 [32] | 3 |
| Current Range (A) | | 15-125 | 15-125 | 15-125 | 15-30 | 15-150 | 15-150 | 15-150 | 15-150 | 15-150 | 70-250 [33] | 70-250 [33] | 70-250 [33] | 70-250 [33] | 70-250 [33] |
| Interrupting Ratings | | | | | | | | | | | | | | | |
| UL/CSA/ NOM AC Rating (kA RMS) (50/60 Hz) | 240 Vac | 25 | 65 | 100 | 100 | 25 | 65 | 100 | 125 | 200 | 25 | 65 | 100 | 125 | 200 |
| | 480Y/277 Vac | 18 [34] | 35 | 65 | 65 | 18 | 35 | 65 | 100 | 200 | 18 | 35 | 65 | 100 | 200 |
| | 480 Vac | 18 [35] | 35 [34] | 65 | 65 | 18 | 35 | 65 | 100 | 200 | 18 | 35 | 65 | 100 | 200 |
| | 600Y/347 Vac | 14 | 18 [34] | 25 | 65 | 14 | 18 | 25 | 50 | 100 | 14 | 18 | 25 | 50 | 100 |
| UL/CSA/ NOM DC Ratings | 250 Vdc [36] | 10 | 20 | 50 | — | 20 | 20 | 20 | 20 | — | 20 | 20 | 20 | 20 | — |
| | 500 Vdc [36] | — | — | — | — | — | 20 | — | 50 | — | — | 20 | — | 50 | — |
| IEC AC Rating (kA RMS) (50/60 Hz) Icu/Ics [36] | 220/240 Vac | 25 | 65 | 100 | 100 | 25 | 65 | 100 | 125 | 150 | 25 | 65 | 100 | 125 | 150 |
| | 380/415 Vac | 18 | 35 | 65 | 65 | 18 | 35 | 65 | 100 | 125 | 18 | 35 | 65 | 100 | 125 |
| | 440/480 Vac | 18 | 35 | 65 | 65 | 18 | 35 | 65 | 100 | 125 | 18 | 35 | 65 | 100 | 125 |
| | 500/525 Vac | 14 | 18 | 25 | 25 | 14 | 18 | 25 | 50 | 75 | 14 | 20 | 20 | 20 | 75 |
| IEC DC Ratings | 250 Vdc | — | — | — | — | — | — | — | — | 20 | — | — | — | — | 20 |
| | 500 Vdc | — | — | — | — | — | — | — | — | — | 20 | 20 | 20 | 20 | — |
| Special Ratings | | | | | | | | | | | | | | | |
| CCC | | X | X | X | X | X | X | X | X | X | X | X | X | X | X |
| HACR | | X | X | X | X | X | X | X | X | X | X | X | X | X | X |
| FCC | | X | X | X | X | X | X | X | X | X | X | X | X | X | X |
| CE | | X | X | X | X | X | X | X | X | X | X | X | X | X | X |
| UKCA | | X | X | X | X | X | X | X | X | X | X | X | X | X | X |
| Connections/Terminations | | | | | | | | | | | | | | | |
| Unit Mount | | X | X | X | X | X | X | X | X | X | X | X | X | X | X |
| I-Line™ | | X | X | X | X | X | X | X | X | X | X | X | X | X | X |
| Rear Connection | | — | — | — | — | X [39] | X [39] | X | X | X | X | X | X | X | X |
| Drawout | | — | — | — | — | X [39] | X [39] | X | X | X | X | X | X | X | X |
| Optional Lugs | | X | X | X | X | X [39] | X [39] | X | X | X | X | X | X | X | X |
| Accessories and Modifications | | | | | | | | | | | | | | | |
| Shunt Trip | | X | X | X | X | X | X | X | X | X | X | X | X | X | X |
| Undervoltage Trip | | X | X | X | X | X | X | X | X | X | X | X | X | X | X |
| Auxiliary Switches | | X | X | X | X | X | X | X | X | X | X | X | X | X | X |
| Alarm Switch | | X | X | X | X | X | X | X | X | X | X | X | X | X | X |
| Motor Operator | | — | — | — | — | X [39] | X [39] | X | X | X | X | X | X | X | X |
| Handle Operators | | X | X | X | X | X [39] | X [39] | X | X | X | X | X | X | X | X |
| Mechanical Interlocks (3P) | | X | X | X | — | X | X | X | X | X | X | X | X | X | X |
| Handle Padlock Attachment | | X | X | X | X | X [39] | X [39] | X | X | X | X | X | X | X | X |
| Cylinder Lock (3P) | | — | — | — | — | — | — | — | — | — | — | — | — | — | — |
| Optional GF Protection | | — | — | — | — | X | X | X | X | X | X | X | X | X | X |
| Trip System Type | | | | | | | | | | | | | | | |
| Thermal-magnetic | | X | X | X | X | X | X | X | X | — | X | X | X | X | X |
| Instantaneous-only (MCP) | | — | — | — | — | — | X | X [40] | X [40] | X [40] | — | X [40] | X [40] | X | X |
| Molded Case Switch (Automatic) | | X | X | X | X | — | X | — | X | — | — | X | — | X | X |
| Electronic | | — | — | — | — | X [40] | X [40] | X [40] | X [40] | X [40] | X [40] | X [40] | X [40] | X [40] | X [40] |
| Product Dimensions | | | | | | | | | | | | | | | |
| Dimensions (3P Unit Mount) in. (mm) | Height | 5.4 (137) | | | | 6.4 (163) | | | | | 7.5 (191) | | | | |
| | Width | 3.2 (81) | | | | 4.1 (104) | | | | | 4.1 (104) | | | | |
| | Depth | 3.5 (89) | | | | 3.4 (86) | | | | | 3.4 (86) | | | | |
| Enclosures (page 7-85–page 7-87) | | | | | | | | | | | | | | | |
| General Purpose (NEMA 1) | | — | — | — | — | X | X | X | X | — | X | X | X | X | — |
| Raintight (NEMA 3R) | | — | — | — | — | X | X | X | X | — | X | X | X | X | — |
| Dust-tight (NEMA 12) | | — | — | — | — | X | X | X | X | — | X | X | X | X | — |
| Watertight (NEMA 4, 4X, 5) | | — | — | — | — | X | X | X | X | — | X | X | X | X | — |
| Explosion Proof (NEMA 7, 9) | | — | — | — | — | — | — | — | — | — | X [41] | X [41] | — | — | — |
| Pages (Unit Mount) / (I-Line) | | page 7-32 / Section 9 | | | | page 7-34 / Section 9 | | | | | page 7-34 / Section 9 | | | | |

NOTE: All circuit breakers on this chart are certified to UL and CSA standards unless otherwise noted.

- [32] 2P in a 3P module.
- [33] 70-250 A with electronic trip system
- [34] Only two pole circuit breaker.
- [35] Only two, three and four pole.
- [36] Not available with electronic trip units
- [37] 1P Available at 125 Vdc
- [38] Dual UL and IEC ratings and CE markings on circuit breakers. For additional IEC ratings, see the Supplemental Digest, Section 10.
- [39] Not available in HD and HG 2P rating (2P module).
- [40] 3P only.
- [41] Not UL Listed due to wire bending space.



PowerPac™ Q-Frame, Q4, LA, LH, L-Frame Molded Case Circuit Breakers

| | | PowerPacT 250 A Q-Frame | | | 400 A LA/LH | | PowerPacT 600 A L-Frame | | | |
|--|------------------|---|-------------|-------------|---|----------|---|--------|--------|--------|
| | |  | | |  | |  | | | |
| Circuit Breaker Type | | QB | QD | QG | LA | LH | LG | LJ | LL | LR |
| Number of Poles | | 2, 3 | 2, 3 | 2, 3 | 2, 3 | 2, 3 | 3, 4 | 3, 4 | 3, 4 | 3, 4 |
| Current Range (A) | | 70–250 [42] | 70–250 [42] | 70–250 [42] | 125–400 | 125–400 | 70–600 | 70–600 | 70–600 | 70–600 |
| Interrupting Ratings | | | | | | | | | | |
| UL/CSA/NOM AC Rating (kA RMS) (50/60 Hz) | 240 Vac | 10 | 25 | 65 | 42 | 65 | 65 | 100 | 125 | 200 |
| | 480Y/277 Vac | — | — | — | 30 | 35 | 35 | 65 | 100 | 200 |
| | 480 Vac | — | — | — | 30 | 35 | 35 | 65 | 100 | 200 |
| | 600Y/347 Vac | — | — | — | 22 | 25 | 18 | 25 | 50 | 100 |
| UL/CSA/NOM DC Ratings | 600 Vac | — | — | — | 22 | 25 | 18 | 25 | 50 | 100 |
| | 250 Vdc [43] | — | — | — | 10 | 50 | — | — | — | — |
| IEC AC Rating (kA RMS) (50/60 Hz) Icu/lcs [45] | 500 Vdc [44][43] | — | — | — | — | 20 | 20 | — | 50 | — |
| | 220/240 Vac | 10/5 | 10/5 | 10/5 | — | — | 65 | 100 | 125 | 150 |
| IEC DC Ratings | 380/415 Vac | 10/5 | 10/5 | 10/5 | 20/5[46] | 20/5[46] | 18 | 65 | 100 | 125 |
| | 440/480 Vac | — | — | — | — | — | 18 | 65 | 100 | 125 |
| | 500/525 Vac | — | — | — | — | — | 14 | 25 | 50 | 75 |
| | 690 Vac | — | — | — | — | — | — | — | — | 20 |
| Special Ratings | | | | | | | | | | |
| CCC | | — | — | — | — | — | X | X | X | X |
| HACR (2P, 3P) | | X | X | X | X | X | X | X | X | X |
| FCC | | — | — | — | — | — | X | X | X | X |
| CE | | — | — | — | — | — | X | X | X | X |
| UKCA | | — | — | — | — | — | X | X | X | X |
| Connections/Terminations | | | | | | | | | | |
| Unit Mount | | X | X | X | X | X | X | X | X | X |
| I-Line™ | | X | X | X | X | X | X | X | X | X |
| Rear Connection | | — | — | — | X | X | X | X | X | X |
| Drawout | | — | — | — | — | — | X | X | X | X |
| Optional Lugs | | — | — | — | X | X | X | X | X | X |
| Accessories and Modifications | | | | | | | | | | |
| Shunt Trip | | — | — | — | X | X | X | X | X | X |
| Undervoltage Trip | | — | — | — | X | X | X | X | X | X |
| Auxiliary Switches | | — | — | — | X | X | X | X | X | X |
| Alarm Switch | | — | — | — | X | X | X | X | X | X |
| Motor Operator | | — | — | — | X | X | X | X | X | X |
| Handle Operators | | — | — | — | X | X | X | X | X | X |
| Mechanical Interlocks (3P) | | X | X | X | X [47] | X [47] | X | X | X | X |
| Handle Padlock Attachment | | X | X | X | X | X | X | X | X | X |
| Cylinder Lock (3P[48]) | | — | — | — | X | X | — | — | — | — |
| Optional GF Protection[49] | | — | — | — | — | — | X | X | X | X |
| Trip System Type | | | | | | | | | | |
| Thermal-magnetic | | X | X | X | X | X | — | — | — | — |
| Instantaneous-only (MCP) | | — | — | — | X | X | X | X | X | X |
| Molded Case Switch (Automatic) | | X | — | — | — | X | — | — | X | X |
| Electronic | | — | — | — | — | — | X | X | X | X |
| Product Dimensions | | | | | | | | | | |
| Dimensions (3P Unit Mount) in. (mm) | Height | 6.47 (164) | | | 11 (279) | | 13.38 (340) | | | |
| | Width | 4.5 (114) | | | 6 (152) | | 5.51 (140) | | | |
| | Depth | 3.93 (100) | | | 5.84 (148) | | 4.33 (110) | | | |
| Enclosures (page 7-85–page 7-87) | | | | | | | | | | |
| General Purpose (NEMA 1) | | X | X | X | X | X | — | — | — | — |
| Raintight (NEMA 3R) | | X | X | X | X | X | — | — | — | — |
| Dust-tight (NEMA 12) | | — | — | — | X | X | X [50] | X [50] | X [50] | X [50] |
| Watertight (NEMA 4, 4X, 5) | | — | — | — | X | X | — | — | — | — |
| Explosion Proof (NEMA 7, 9) | | — | — | — | — | — | — | — | — | — |
| Pages (Unit Mount) / (I-Line) | | page 7-38 / Supplemental Section 9 | | | page / Supplemental Section 9 | | page 7-40 / Supplemental Section 9 | | | |

NOTE: All circuit breakers on this chart are certified to UL and CSA standards unless otherwise noted.

[42] I-Line Q-frame circuit breakers are available 70–225 A only. 250 A Q-frame unit-mount circuit breakers are limited to Cu conductors only.
 [43] Not available with electronic trip units
 [44] Ungrounded UPS systems only. See page 7-47. Special DC J-Frame only.
 [45] Dual UL and IEC ratings and CE markings on circuit breakers. For additional IEC ratings, see the Supplemental Digest, Section 10.
 [46] For additional IEC ratings, see the Supplemental Digest Section 10.
 [47] Requires circuit breaker with WB suffix.
 [48] Factory-installed option only.
 [49] Requires factory-installed "G" shunt trip and 3P module.
 [50] Enclosure rating 1, 3R, 5 and 12.,

M-, P-, and R-Frame Molded Case Circuit Breakers

| | PowerPacT 800 A M-Frame | | PowerPacT 1200 A P-Frame | | | | PowerPacT 3000 A R-Frame | | | | |
|---|---|-------------|---|-------------|----------|----------|---|-------------|----------|----------|--------|
| |  | |  | | | |  | | | | |
| Circuit Breaker Type | MG | MJ | PG | PJ | PK | PL | RG | RJ | RK | RL | |
| Number of Poles | 2, 3 | 2, 3 | 2, 3, 4 | 2, 3, 4 | 2, 3, 4 | 2, 3, 4 | 2, 3, 4 | 2, 3, 4 | 2, 3, 4 | 2, 3, 4 | |
| Current Range (A) | 300–800 | 300–800 | 100–1200 | 100–1200 | 100–1200 | 100–1200 | 240–3000 | 240–3000 | 240–3000 | 240–3000 | |
| Interrupting Ratings | | | | | | | | | | | |
| UL/CSA/NOM Rating (KA RMS) (50/60 Hz) | 240 Vac | 65 | 100 | 65 | 100 | 65 | 125 | 65 | 100 | 65 | 125 |
| | 480Y/277 Vac | 35 | 65 | 35 | 65 | 50 | 100 | 35 | 65 | 65 | 100 |
| | 480 Vac | 35 | 65 | 35 | 65 | 50 | 100 | 35 | 65 | 65 | 100 |
| | 600Y/347 Vac | 18 | 25 | 18 | 25 | 50 | — | 18 | 25 | 65 | 50 |
| DC Ratings | 600 Vac | 18 | 25 | 18 | 25 | 50 | — | 18 | 25 | 65 | 50 |
| | 250 Vdc | — | — | — | — | — | — | — | — | — | — |
| IEC (KA RMS) (50/60 Hz) Icu/Ics [52] | 500 Vdc [51] | — | — | — | — | — | — | — | — | — | — |
| | 240 Vac | 50/25 | 65/35 | 50/25 | 65/35 | 50/25 | 125/65 | 50/25 | 65/35 | 85/65 | 125/65 |
| | 415 Vac | 35/20 | 50/25 | 35/20 | 50/25 | 50/25 | 85/45 | 35/20 | 50/25 | 70/55 | 85/45 |
| Special Ratings | | | | | | | | | | | |
| CCC | X | X | X | X | X | X | X | X | X | X | |
| HACR (2P, 3P) | X | X | X | X | X | X | X | X | X | X | |
| FCC | X | X | X | X | X | X | X | X | X | X | |
| CE | X | X | X | X | X | X | X | X | X | X | |
| UKCA | X | X | X | X | X | X | X | X | X | X | |
| Connections/Terminations | | | | | | | | | | | |
| Unit Mount | X | X | X | X | X | X | X | X | X | X | |
| I-Line™ | X | X | X | X | X | X | X | X [53] | X [53] | X [53] | |
| Rear Connection | — | — | — | — | — | — | — | — | — | — | |
| Drawout | — | — | X [54] | X [54] | X [54] | X [54] | — | — | — | — | |
| Optional Lugs | X | X | X | X | X | X | X | X | X | X | |
| Accessories and Modifications | | | | | | | | | | | |
| Shunt Trip | X | X | X | X | X | X | X | X | X | X | |
| Undervoltage Trip | X | X | X | X | X | X | X | X | X | X | |
| Auxiliary Switches | X | X | X | X | X | X | X | X | X | X | |
| Alarm Switch | X | X | X | X | X | X | X | X | X | X | |
| Motor Operator | — | — | X [54] | X [54] | X [54] | X [54] | — | — | — | — | |
| Handle Operators | — | — | X [54] | X [54] | X [54] | X [54] | — | — | — | — | |
| Mechanical Interlocks (3P) | — | — | X | X | X | X | — | — | — | — | |
| Handle Padlock Attachment | X | X | X | X | X | X | X | X | X | X | |
| Cylinder Lock (3P) | — | — | — | — | — | — | — | — | — | — | |
| Optional GF Protection | — | — | X | X | X | X | X | X | X | X | |
| Trip System Type | | | | | | | | | | | |
| Thermal-magnetic | — | — | — | — | — | — | — | — | — | — | |
| Instantaneous-only (MCP) | — | — | — | X | X | — | — | — | — | — | |
| Molded Case Switch (Automatic) | X | X | X | X | X | X | X | X | X | X | |
| Electronic | X | X | X | X | X | X | X | X | X | X | |
| Product Dimensions | | | | | | | | | | | |
| Dimensions (3P Unit Mount) | Height—in. (mm) | 12.80 (325) | | 16.20 (413) | | | | 15 (381) | | | |
| | Width—in. (mm) | 8.30 (210) | | 8.30 (210) | | | | 16.50 (420) | | | |
| | Depth—in. (mm) | 8.10 (205) | | 8.10 (205) | | | | 14.40 (366) | | | |
| Enclosures (page 7-85–page 7-87) | | | | | | | | | | | |
| General Purpose (NEMA 1) | X | X | X | X | X | X | — | — | — | — | |
| Raintight (NEMA 3R) | X | X | X | X | X | X | — | — | — | — | |
| Dust-tight (NEMA 12) | X | X | X | X | X | X | — | — | — | — | |
| Watertight (NEMA 4, 4X, 5) | X | X | — | — | — | — | — | — | — | — | |
| Explosion Proof (NEMA 7, 9) | — | — | — | — | — | — | — | — | — | — | |
| Pages (Unit Mount) / (I-Line) | page 7-42 / Section 9 | | page 7-43, page 7-48 / Section 9 | | | | page 7-44, page 7-48 / Section 9 | | | | |

NOTE: All circuit breakers on this chart are certified to UL and CSA standards unless otherwise noted.

[51] Ungrounded UPS systems only. See page 7-47.

[52] Dual UL and IEC ratings and CE markings on circuit breakers. For additional IEC ratings, see the Supplemental Digest, Section 10.

[53] 1000 A and 1200 A only.

[54] 65/50 kA Icu/Ics for 450–600 A ratings.

MasterPacT MTZ Molded Case Circuit Breakers

| | | MasterPacT MTZ1 800–1600 A | | | | | MasterPacT MTZ2 800–6000 A | | | | MasterPacT MTZ3 4000–6000 A | | | |
|--------------------------------------|-------------------------|---|----------|----------|----------|--------------|--|----------|----------|--------------|---|-----------|-------------|-----------|
| | |  | | | | |  | | | |  | | | |
| Circuit Breaker Type | | MTZ1-N | MTZ1-H | MTZ1-L1 | MTZ1-L | MTZ1-LF [55] | MTZ2-N | MTZ2-H | MTZ2-L | MTZ2-LF [55] | MTZ2-H | MTZ2-L | MTZ3-H | MTZ3-L |
| Number of Poles | | 3, 4 | 3, 4 | 3 | 3 | 3 | 3, 4 | 3, 4 | 3 | 3 | 3, 4 | 3 | 3, 4 | 3 |
| Current Range | | 400–1200 | 400–1200 | 400–1200 | 400–1200 | 400–1200 | 400–2000 | 400–2000 | 400–2000 | 400–2000 | 1200–3000 | 1200–3000 | 2000–6000 | 2000–6000 |
| Interrupting Ratings | | | | | | | | | | | | | | |
| UL/CSA Rating (kA RMS) (50/60 Hz) | 240 Vac | 50 | 65 | 100 | 200 | 200 | 65 | 100 | 200 | 200 | 100 | 200 | 100 | 200 |
| | 480Y/277 Vac | 50 | 50 | 65 | 100 | 100 | 65 | 100 | 150 | 150 | 100 | 150 | 100 | 150 |
| | 480 Vac | 50 | 50 | 65 | 100 | 100 | 65 | 100 | 150 | 150 | 100 | 150 | 100 | 150 |
| | 600Y/347 Vac | 35 | 50 | — | — | — | 50 | 85 | 100 | 100 | 85 | 100 | 85 | 100 |
| DC Ratings | 600 Vac | 35 | 50 | — | — | — | 50 | 85 | 100 | 100 | 85 | 100 | 85 | 100 |
| | 250 Vdc | — | — | — | — | — | — | — | — | — | — | — | — | — |
| IEC [56] (kA RMS) Icu/ Ics | 500 Vdc | — | — | — | — | — | — | — | — | — | — | — | — | — |
| | 240 Vac | — | — | — | — | — | — | — | — | — | — | — | — | — |
| Special Ratings | 415 Vac | — | — | — | — | — | — | — | — | — | — | — | — | — |
| | CCC | — | — | — | — | — | — | — | — | — | — | — | — | — |
| | Fed. Specs W-C-375B/GEN | — | — | — | — | — | — | — | — | — | — | — | — | — |
| HACR (2P, 3P) | — | — | — | — | — | — | — | — | — | — | — | — | — | |
| Connections/Terminations | | | | | | | | | | | | | | |
| Unit Mount | | X | X | X | X | X | X | X | X | X | X | X | X | X |
| I-Line™ | | — | — | — | — | — | — | — | — | — | — | — | — | — |
| Rear Connection | | X | X | X | X | X | X | X | X | X | X | X | X | X |
| Drawout | | X | X | X | X | X | X | X | X | X | X | X | X | X |
| Optional Lugs | | — | — | — | — | — | — | — | — | — | — | — | — | — |
| Accessories and Modifications | | | | | | | | | | | | | | |
| Shunt Trip | | X | X | X | X | X | X | X | X | X | X | X | X | X |
| Undervoltage Trip | | X | X | X | X | X | X | X | X | X | X | X | X | X |
| Auxiliary Switches | | X | X | X | X | X | X | X | X | X | X | X | X | X |
| Alarm Switch | | X | X | X | X | X | X | X | X | X | X | X | X | X |
| Motor Operator | | X | X | X | X | X | X | X | X | X | X | X | X | X |
| Handle Operators | | — | — | — | — | — | — | — | — | — | — | — | — | — |
| Mechanical Interlocks | | X | X | X | X | X | X | X | X | X | X | X | X | X |
| Padlock Attachment | | X | X | X | X | X | X | X | X | X | X | X | X | X |
| Optional GF Protection | | X | X | X | X | X | X | X | X | X | X | X | X | X |
| Trip System Type | | | | | | | | | | | | | | |
| Thermal-magnetic | | — | — | — | — | — | — | — | — | — | — | — | — | — |
| Instantaneous-only (MCP) | | — | — | — | — | — | — | — | — | — | — | — | — | — |
| Electronic | | X | X | X | X | X | X | X | X | X | X | X | X | X |
| Product Dimensions | | | | | | | | | | | | | | |
| Dimensions (3P Drawout) in. (mm) | Height | 12.67 (322) | | | | | 17.28 (439) | | | | 17.28 (439) | | 17.28 (439) | |
| | Width | 11.25 (286) | | | | | 17.74 (450) | | | | 17.74 (450) | | 30.94 (786) | |
| | Depth | 13.54 (344) | | | | | 18.50 (470) | | | | 18.50 (470) | | 18.50 (470) | |
| Enclosures | | | | | | | | | | | | | | |
| General Purpose (NEMA 1) | | — | — | — | — | — | — | — | — | — | — | — | — | — |
| Raintight (NEMA 3R) | | — | — | — | — | — | — | — | — | — | — | — | — | — |
| Dust-tight (NEMA 12) | | — | — | — | — | — | — | — | — | — | — | — | — | — |
| Watertight (NEMA 4, 4X, 5) | | — | — | — | — | — | — | — | — | — | — | — | — | — |
| Explosion Proof (NEMA 7, 9) | | — | — | — | — | — | — | — | — | — | — | — | — | — |
| Pages | | MasterPacT™ Power Circuit Breakers, page 7-70 and Catalog 0614CT1701 | | | | | | | | | | | | |

NOTE: All circuit breakers on this chart are certified to UL and CSA standards unless otherwise noted.

[55] Tested to show arc flash hazard risk category as reference by NFPA70E.

[56] See Catalog 0614CT1701 for additional ratings and other information.

MasterPac[™] NT, NW Molded Case Circuit Breakers

| | | MasterPac [™] 1200 A | | | | | MasterPac [™] 6000 A | | | | | | | |
|---------------------------------------|--------------|---|----------|----------|----------|------------|--|----------|----------|-------------|----------|----------|-------------|-----------|
| | |  | | | | |  | | | | | | | |
| Circuit Breaker Type | | NT-N | NT-H | NT-L1 | NT-L | NT-LF [57] | NW-N | NW-H | NW-L | NW-LF [57] | NW-H | NW-L | NW-H | NW-L |
| Number of Poles | | 3, 4 | 3, 4 | 3 | 3 | 3 | 3, 4 | 3, 4 | 3 | 3 | 3, 4 | 3 | 3, 4 | 3 |
| Current Range | | 100–1200 | 100–1200 | 100–1200 | 100–1200 | 100–1200 | 100–2000 | 100–2000 | 100–2000 | 100–2000 | 640–3000 | 640–3000 | 1200–6000 | 1200–6000 |
| Interrupting Ratings | | | | | | | | | | | | | | |
| UL/CSA/NOM Rating (kA RMS) (50/60 Hz) | 240 Vac | 50 | 65 | 100 | 200 | 200 | 65 | 100 | 200 | 200 | 100 | 200 | 100 | 200 |
| | 480Y/277 Vac | 50 | 50 | 65 | 100 | 100 | 65 | 100 | 150 | 150 | 100 | 150 | 100 | 150 |
| | 480 Vac | 50 | 50 | 65 | 100 | 100 | 65 | 100 | 150 | 150 | 100 | 150 | 100 | 150 |
| | 600Y/347 Vac | 35 | 50 | — | — | — | 50 | 85 | 100 | 100 | 85 | 100 | 85 | 100 |
| DC Ratings | 250 Vdc | — | — | — | — | — | — | — | — | — | — | — | — | — |
| | 500 Vdc | — | — | — | — | — | — | — | — | — | — | — | — | — |
| IEC [58] (kA RMS) Icu/ Ics | 240 Vac | — | — | — | — | — | — | — | — | — | — | — | — | — |
| | 415 Vac | — | — | — | — | — | — | — | — | — | — | — | — | — |
| Special Ratings | | | | | | | | | | | | | | |
| CCC | | — | — | — | — | — | — | — | — | — | — | — | — | — |
| Fed. Specs W-C-375B/GEN | | — | — | — | — | — | — | — | — | — | — | — | — | — |
| HACR (2P, 3P) | | — | — | — | — | — | — | — | — | — | — | — | — | — |
| Connections/Terminations | | | | | | | | | | | | | | |
| Unit Mount | | X | X | X | X | X | X | X | X | X | X | X | X | X |
| I-Line™ | | — | — | — | — | — | — | — | — | — | — | — | — | — |
| Rear Connection | | X | X | X | X | X | X | X | X | X | X | X | X | X |
| Drawout | | X | X | X | X | X | X | X | X | X | X | X | X | X |
| Optional Lugs | | — | — | — | — | — | — | — | — | — | — | — | — | — |
| Accessories and Modifications | | | | | | | | | | | | | | |
| Shunt Trip | | X | X | X | X | X | X | X | X | X | X | X | X | X |
| Undervoltage Trip | | X | X | X | X | X | X | X | X | X | X | X | X | X |
| Auxiliary Switches | | X | X | X | X | X | X | X | X | X | X | X | X | X |
| Alarm Switch | | X | X | X | X | X | X | X | X | X | X | X | X | X |
| Motor Operator | | X | X | X | X | X | X | X | X | X | X | X | X | X |
| Handle Operators | | — | — | — | — | — | — | — | — | — | — | — | — | — |
| Mechanical Interlocks | | X | X | X | X | X | X | X | X | X | X | X | X | X |
| Padlock Attachment | | X | X | X | X | X | X | X | X | X | X | X | X | X |
| Cylinder Lock | | — | — | — | — | — | — | — | — | — | — | — | — | — |
| Optional GF Protection | | X | X | X | X | X | X | X | X | X | X | X | X | X |
| Trip System Type | | | | | | | | | | | | | | |
| Thermal-magnetic | | — | — | — | — | — | — | — | — | — | — | — | — | — |
| Instantaneous-only (MCP) | | — | — | — | — | — | — | — | — | — | — | — | — | — |
| Molded Case Switch (Automatic) | | X | X | X | X | X | X | X | X | X | X | X | X | X |
| Electronic | | X | X | X | X | X | X | X | X | X | X | X | X | X |
| Product Dimensions | | | | | | | | | | | | | | |
| Dimensions (3P Drawout) in. (mm) | Height | 12.67 (322) | | | | | 17.28 (439) | | | 17.28 (439) | | | 17.28 (439) | |
| | Width | 11.25 (286) | | | | | 17.74 (450) | | | 17.74 (450) | | | 30.94 (786) | |
| | Depth | 13.00 (331) | | | | | 18.38 (467) | | | 18.38 (467) | | | 18.38 (467) | |
| Enclosures | | | | | | | | | | | | | | |
| General Purpose (NEMA 1) | | — | — | — | — | — | — | — | — | — | — | — | — | — |
| Raintight (NEMA 3R) | | — | — | — | — | — | — | — | — | — | — | — | — | — |
| Dust-tight (NEMA 12) | | — | — | — | — | — | — | — | — | — | — | — | — | — |
| Watertight (NEMA 4, 4X, 5) | | — | — | — | — | — | — | — | — | — | — | — | — | — |
| Explosion Proof (NEMA 7, 9) | | — | — | — | — | — | — | — | — | — | — | — | — | — |
| Pages | | page 7-77 and Catalog 0613CT0001 | | | | | page 7-77 and Catalog 0613CT0001 | | | | | | | |

NOTE: All circuit breakers on this chart are certified to UL and CSA standards unless otherwise noted.

7 MINIATURE AND MOLDED CASE CIRCUIT BREAKERS

[57] Tested to show arc flash hazard risk category as reference by NFPA70E.
[58] See Catalog 0613CT0001 for additional ratings and other information.

QO Standard Plug-On Circuit Breakers

Square D brand QO miniature circuit breakers are plug-on products for use in QO and QON load centers, NQ panelboards, NQ OEM interiors or Speed-D™ switchboard distribution panels. Bolt-on QOB circuit breakers are for use in NQOB and NQ panelboards or interiors. [1]

The Square D exclusive Qwik-Open™ mechanism, with a trip reaction within 1/60th of a second, is standard on all 1P 15 and 20 A QO circuit breakers.



Table 7.1: Standard QO Plug-On Circuit Breakers

| Amperes Rating [2] | 1P—120/240 Vac | 2P—120/240 Vac Common Trip | 2P—240 Vac [3] Common Trip | 3P—240 Vac Common Trip |
|--------------------------------------|----------------|----------------------------|----------------------------|------------------------|
| 10 k AIR | | | | |
| 10 A | QO110 | QO210 | — | QO310 |
| 15 A | QO115 [4] [5] | QO215 [4] | QO215H | QO315 [4] |
| 20 A | QO120 [4] [5] | QO220 [4] | QO220H | QO320 [4] |
| 25 A | QO125 [4] | QO225 [4] | QO225H OBS | QO325 [4] |
| 30 A | QO130 [4] | QO230 [4] | QO230H | QO330 [4] |
| 35 A | QO135 [4] | QO235 [4] | — | QO335 [4] |
| 40 A | QO140 [4] | QO240 [4] | QO240H | QO340 [4] |
| 45 A | QO145 OBS | QO245 [4] | — | QO345 [4] |
| 50 A | QO150 [4] | QO250 [4] | QO250H OBS | QO350 [4] |
| 60 A | QO160 [4] | QO260 [4] | QO260H OBS | QO360 [4] |
| 70 A | QO170 [4] | QO270 [4] | QO270H OBS | QO370 [4] |
| 80 A | — | QO280 [4] | QO280H OBS | QO380 [4] |
| 90 A | — | QO290 [4] | QO290H OBS | QO390 [4] |
| 100 A | — | QO2100 [4] | QO2100H | QO3100 [4] |
| 110 A | — | QO2110 [4] | — | — |
| 125 A | — | QO2125 [4] | — | — |
| 150 A | — | QO2150 [4] [6] | — | — |
| 175 A | — | QO2175 [4] [7] [6] | — | — |
| 200 A | — | QO2200 [4] [7] [6] | — | — |
| Molded Case Switch 60 A max.—240 Vac | | — | QO200 | QO300 OBS |
| 22 k AIR [4] | | | | |
| 15 A | QO115VH [5] | QO215VH [8] | — | QO315VH [8] |
| 20 A | QO120VH [5] | QO220VH [8] | — | QO320VH [8] |
| 25 A | — | QO225VH [8] | — | QO325VH [8] |
| 30 A | QO130VH | QO230VH [8] | — | QO330VH [8] |
| 40 A | QO140VH | QO240VH [8] | — | QO340VH [8] |
| 50 A | — | QO250VH [8] | — | QO350VH [8] |
| 60 A | QO160VH | QO260VH [8] | — | QO360VH [8] |
| 70 A | — | QO270VH [8] | — | QO370VH [8] |
| 80 A | — | QO280VH [8] | — | QO380VH [8] |
| 90 A | — | QO290VH [8] | — | QO390VH [8] |
| 100 A | — | QO2100VH [8] [9] | — | QO3100VH [8] |
| 110 A | — | QO2110VH [8] [9] | — | — |
| 125 A | — | QO2125VH [8] [9] | — | — |
| 150 A | — | QO2150VH [7] [8] [6] | — | — |
| 175 A | — | QO2175VH OBS | — | — |
| 200 A | — | QO2200VH [7] [8] [6] | — | — |
| 42 k AIR [4] | | | | |
| 40 A | — | QOH240 OBS | — | — |
| 45 A | — | QOH245 OBS | — | — |
| 50 A | — | QOH250 OBS | — | — |
| 60 A | — | QOH260 [10] | — | — |
| 70 A | — | QOH270 | — | — |
| 80 A | — | QOH280 | — | — |
| 90 A | — | QOH290 | — | — |
| 100 A | — | QOH2100 | — | — |
| 110 A | — | QOH2110 [10] | — | — |
| 125 A | — | QOH2125 | — | — |
| 65 k AIR [4] | | | | |
| 15 A | QH115 OBS | QH215 OBS | — | QH315 OBS |
| 20 A | QH120 [5] | QH220 | — | QH320 OBS |
| 25 A | QH125 OBS | QH225 OBS | — | QH325 [10] |
| 30 A | QH130 OBS | QH230 | — | QH330 OBS |

OBS This product is obsolete.

Refer to page 7-2 for Interrupting Ratings, Accessories, and Dimensions.

[1] See Digest Section 1 for load centers and Section 9 for panelboards and interiors.
 [2] 10–30 A circuit breakers are suitable for use with 60°C or 75°C conductors. 35–125 A circuit breakers are suitable for use with 75°C conductors.
 [3] UL Listed 5 k AIR on corner grounded Delta systems.
 [4] UL Listed as HACR type for use with air conditioning, heating and refrigeration equipment having motor group combinations and marked for use with HACR type circuit breakers.
 [5] UL Listed as SWD (switching duty) rated. Suitable for switching 120 Vac fluorescent lighting loads.
 [6] Not suitable for use in 3Ø panels. Use only in 1Ø panel rated 150 A or greater.
 [7] Requires four spaces (1 AWG–300 kcmil Al/Cu.) Suitable for switching 120 Vac fluorescent lighting loads.
 [8] UL Listed for use ahead of QO, QO-GFI, QO-EPD, QOT, QO-AFI, and QO-PL 10 k AIR circuit breakers to permit their application at 22 kA fault level.
 [9] 100 A maximum branch mounted opposite.
 [10] Order only. Contact your local Field Office.

Table 7.2: QO/QOB 48 Vdc 5 kA

| Ampere Rating | Poles | Suffix |
|---------------|-------|--------|
| 10–60 A | 2 | 5272 |

QO/QOB Ring Terminal

Table 7.3: QO/QOB Ring Terminal—Factory-Installed Only

| Ampere Rating | Poles | Suffix |
|---------------|---------|--------|
| 10–30 A | 1, 2, 3 | 5237 |
| 35–60 A | 1, 2 | 5238 |
| 35–50 A | 3 | |
| 70–110 A | 2 | |
| 60–100 A | 3 | 5273 |

Wire Sizes for QO/QOB Circuit Breakers

Table 7.4: Wire Sizes for QO/QOB Circuit Breakers

| Circuit Breaker Type | Ampere Rating [11] | Wire Size (AWG/kcmil) |
|--------------------------|--------------------|--------------------------|
| QO 1P | 10–30 A | 14–8 Al/Cu |
| | 10–30 A | (2) 14–10 Cu |
| | 35–70 A | 8–2 Al/Cu |
| QO 2P | 10–30 A | 14–8 Al/Cu |
| | 10–30 A | (2) 14–10 Cu |
| | 35–70 A | 8–2 Al/Cu |
| | 80–125 A | 4–2/0 Al/Cu |
| QO 3P | 10–30 A | 14–8 Al/Cu, (2) 14–10 Cu |
| | 35–70 A | 8–2 Al/Cu |
| | 80–125 A | 4–2/0 Al/Cu |
| QOB-VH | 110–150 A | 4–300 Al/Cu |
| QOT | 15–20 A | 12–8 Al 14–8 Cu |
| QO-AFI, QO-GFI or QO-EPD | 15–30 A | 12–8 Al 14–8 Cu |
| | 40, 50, 60 A | 12–4 Al 14–6 Cu |
| QO-PL | 10–60 A | 12–2 Al 14–2 Cu |

QOT and QO Tandem Circuit Breakers

QOT tandem circuit breakers have a mounting cam as shown. Installation into a QO load center can only be made in those positions having a mounting pan rail slot. Meets Paragraph 408.54 of the NEC®. UL Listed as Class CTL.



QOT 1P Tandem
1 Space Required

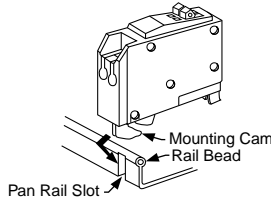

Table 7.5: QOT Tandem Circuit Breakers (CTL)—Not Compatible with Plug-on Neutral Systems

| Ampere Rating [11] | Cat. No. [12] |
|--|---------------|
| 1P—120/240 Vac | |
| 15 A and 15 A | QOT1515 |
| 15 A and 20 A | QOT1520 |
| 20 A and 20 A | QOT2020 |
| 2P—120/240 Vac Common Trip | |
| Order two QOT1515 or QOT2020 circuit breakers and handle tie QOTHT for common switching of center two poles. | |

Table 7.6: QO Tandem Circuit Breakers (non-CTL)—Compatible with Plug-on Neutral Systems

| Ampere Rating [11] | Cat. No. [12] |
|---|--|
| 1P—120/240 Vac—1 Space Required | |
| 15 A and 15 A | QO1515 |
| 15 A and 20 A | QO1520 |
| 20 A and 20 A | QO2020 |
| 20 A and 30 A | QO2030 |
| 30 A and 20 A | QO3020 |
| Two 1P Individual Trip—120/240 Vac—2 Spaces Required | |
| 15 A and 15 A | Order two QO1515 or QO2020 circuit breakers and handle tie QOTHT |
| 15 A and 20 A | |
| 20 A and 20 A | — |
| 20 A and 30 A | QO20303020 [13] |
| 30 A and 20 A | — |

NOTE: The torque values for these products can be found at www.se.com

[11] 10–30 A circuit breakers are suitable for use with 60°C or 75°C conductors. 35–125 A circuit breakers are suitable for use with 75°C conductors.

[12] UL Listed as HACR type for use with air conditioning, heating and refrigeration equipment having motor group combinations and marked for use with HACR type circuit breakers.

[13] Includes two circuit breakers (one QO2030 and one QO3020) and handle tie QOTHT.

QO Arc-Fault Circuit Breaker (QO-CAFI)

QO arc-fault circuit breakers provide protection for Series and Parallel Type Arcing as required by the NEC and local code adoption, and comply with UL 1699.



1P QO-CAFI Plug-On Neutral

1P QO-CAFI Pigtail

Table 7.7: QO-CAFI Circuit Breakers

| Circuit Breaker Type [14] | Ampere Rating | One-Pole 120 Vac | | Two-Pole 120/240 Vac |
|---|---------------|------------------------------|------------------------------|----------------------------------|
| | | 10 k AIR 1 Space Required | 22 k AIR 1 Space Required | 10 k AIR 2 Space Required |
| Combination Arc-fault Interrupter (Pigtail Neutral) | 15 20 | QO115CAFI QO120CAFI | QO115VHCAFI QO120VHCAFI | QO215CAFI [15] QO220CAFI [15] |
| Plug-On Neutral Combination Arc-fault Interrupter | 15 20 | QO115PAF QO120PAF | QO115VHPAF QO120VHPAF | — |

QO Dual Function Circuit Breaker

QO Combination Arc Fault and Ground Fault Circuit Interrupters (Dual Function) provide overload and short circuit protection, plus arc fault and ground fault protection in accordance with the NEC, UL 1699 and UL943.



1P QO-DF Plug-on Neutral

1P QO-DF Pigtail

Table 7.8: QO-DF Circuit Breakers

| Circuit Breaker Type [14] | Ampere Rating | 1P 120 Vac 10 k AIR 1 Space Required | 1P 120 Vac 22 k AIR 1 Space Required |
|--|---------------|--|--|
| Combination Arc-fault and Ground Fault Circuit Interrupter (Pigtail Neutral) | 15 20 | QO115DF QO120DF | — QO120VHDF |
| Plug-On Neutral Combination Arc-fault and Ground Fault Circuit Interrupter | 15 20 | QO115PAFGF QO120PAFGF | QO115VHPAFGF QO120VHPAFGF |

QO Ground-Fault Circuit Breakers (GFI)

Qwik-Gard™ circuit breakers provide overload and short circuit protection, combined with Class A ground fault protection. Class A denotes a ground fault circuit interrupter that will trip when a fault current to ground is 6 mA or more, for people protection. Do not connect to more than 250 feet of load conductor for the total one-way run to prevent nuisance tripping.



1P QO-GFI

2P QO-GFI

Table 7.9: QO-GFI Circuit Breakers

| Circuit Breaker Type | Ampere Rating [16] | Qwik-Gard Circuit Breakers With Ground Fault Circuit Interrupter | | | |
|--|--------------------|--|------------------------------|-------------------------------|--------------------------------|
| | | 1P 120 Vac | | 2P Common Trip 120/240 Vac | 3P Common Trip 208Y/120 Vac |
| | | 10 k AIR 1 Space Required | 22 k AIR 1 Space Required | 10 k AIR 2 Spaces Required | 10 k AIR 3 Spaces Required |
| Ground-Fault Circuit Interrupter (Pigtail Neutral) | 15 | QO115GFI | QO115VHGFI | QO215GFI | QO315GFI |
| | 20 | QO120GFI | QO120VHGFI | QO220GFI | QO320GFI |
| | 25 | — | — | QO225GFI | — |
| | 30 | QO130GFI | — | QO230GFI | QO330GFI |
| | 35 | — | — | QO235GFI | — |
| | 40 | — | — | QO240GFI | QO340GFI |
| | 45 | — | — | QO245GFI | — |
| | 50 | — | — | QO250GFI | QO350GFI |
| Plug-On Neutral Ground-Fault Circuit Interrupter | 15 | QO115PGFI [18] | — | — | — |
| | 20 | QO120PGFI [18] | — | — | — |

[14] UL Listed as HACR type for use with air conditioning, heating and refrigeration equipment having motor group combinations and marked for use with HACR type circuit breakers.

[15] For 120/240 V only, not for 208Y/120 V.

[16] 10–30 A circuit breakers are suitable for use with 60°C or 75°C conductors. 35–125 A circuit breakers are suitable for use with 75°C conductors.

[17] Suitable only for feeding 240 Vac and 208 Vac two-wire loads. Does not contain load neutral connection.

[18] New Plug-On Neutral

QO-EPD/EPE Circuit Breakers

QO-EPD/EPE circuit breakers provide overload and short circuit protection combined with Class B ground fault protection. They are designed to provide ground fault protection of equipment at a 30 mA level (EPD) or 100 mA level (EPE). They are not designed to protect people from electrical shock.



QO220EPD

Table 7.10: QO-EPD Circuit Breakers

| Ampere Rating [19] | 1P 120 Vac 10 k AIR 1 Space Required | 2P Common Trip 120/240 Vac 10 k AIR 2 Spaces Required | |
|--------------------|---|--|---------------|
| 15 | QO115EPD | QO215EPD | QO315EPE [20] |
| 20 | QO120EPD | QO220EPD | QO320EPE [20] |
| 25 | QO125EPD ^{Obs} | QO225EPD | — |
| 30 | QO130EPD | QO230EPD | QO330EPE [20] |
| 40 | — | QO240EPD | QO340EPE [20] |
| 50 | — | QO250EPD | QO350EPE [20] |
| 60 | — | QO260EPD [21] | — |

^{Obs} This product is obsolete.

QO Switch Neutral Common Trip Circuit Breakers (QO-SWN)

Switch Neutral Common Trip 2008 NEC® 514.11

Table 7.11: QO-SWN Circuit Breakers

| Ampere Rating [22] | 2 Wire 120 Vac 10 k AIR 2 Spaces Required |
|--------------------|---|
| 15 | QO215SWN |
| 20 | QO220SWN |

QO High Intensity Discharge Circuit Breakers (QO-HID)

HID circuit breakers are for use on circuits feeding fluorescent and high intensity discharge (HID) lighting systems such as mercury vapor, metal halide, or high pressure sodium. These circuit breakers are physically interchangeable with QO circuit breakers.

Table 7.12: QO-HID Circuit Breakers

| Ampere Rating [22] | 1P 120/240 Vac 10 k AIR | 2P Common Trip 120/240 Vac 10 k AIR | 3P Common Trip 240 Vac 10 k AIR |
|--------------------|----------------------------|---|---------------------------------------|
| 20 | — | QO220HID | QO320HID |



QO320HID

[19] 10–30 A circuit breakers are suitable for use with 60°C or 75°C conductors. 35–125 A circuit breakers are suitable for use with 75°C conductors.
 [20] See note in Instruction Bulletin when using in an enclosure with a QO403 or QON prefix.
 [21] Suitable only for feeding 240 Vac and 208 Vac two-wire loads. Does not contain load neutral connection.
 [22] 10–30 A circuit breakers are suitable for use with 60°C or 75°C conductors. 35–60 A circuit breakers are suitable for use with 75°C conductors.

QO High Magnetic Trip Circuit Breakers (QO-HM)

High magnetic trip circuit breakers are recommended for applications where high initial inrush may occur and for individual dimmer applications.

Table 7.13: QO-HM Circuit Breakers

| 120 Vac—10 k AIR | |
|--------------------|-------------------|
| Ampere Rating [23] | 1P |
| 15 A | QO115HM [24] [25] |
| 20 A | QO120HM [24] [25] |

Non-Automatic (Standard) Miniature Switches

Miniature non-automatic switches have the same physical packaging as miniature circuit breakers, but open only when the handle is switched to the OFF position.

Non-automatic switches provide no overcurrent protection or short circuit protection. They must not be used on systems that have an available fault current greater than the values listed in the table. Non-automatic switches are UL Listed per UL 1087 and are CSA certified.

Table 7.14: QO Non-Automatic Miniature Switches, 240 Vac 10 kA

| Ampere Rating | 2P | 3P |
|---------------|-------|-----------|
| 60 | QO200 | QO300 OBS |

^{OBS} This product is obsolete.

[23] 10–30 A circuit breakers are suitable for use with 60oC or 75oC conductors. 35–60 A circuit breakers are suitable for use with 75oC conductors.

[24] UL Listed as HACR type for use with air conditioning, heating and refrigeration equipment having motor group combinations and marked for use with HACR type circuit breakers.

[25] UL Listed as SWD (switching duty) rated. Suitable for switching 120 Vac fluorescent lighting loads.

Accessories for QO/QOB Circuit Breakers

Table 7.15: Accessories for use with QO and QOB Miniature Circuit Breakers

| Description | | Cat. No. | Schedule |
|--|--|--|-----------------------------|
| Handle Attachments | | | |
| Handle Tie | Converts any two adjacent 120/240 Vac 1P QO circuit breakers to independent trip 2P Converts any two adjacent 120/240 Vac1P side-by-side QOT circuit breakers to independent trip 2P | QO1HT QOTHT QO3HT | DE2E DE2E |
| Handle Clamp | Clamp for holding QO 1P handle in ON or OFF position Clamp for holding QO or Q1 either 1P, 2P or 3P circuit breaker handles in ON or OFF position | QO1LO HLO1 | DE2E DE2E |
| Handle Padlock Attachment for Padlocking in ON or OFF position | For padlocking 1P QO circuit breaker in ON or OFF position Loose attachment Fixed attachment | QOHPL QO1PA | DE2E DE2E |
| | For padlocking 1P side-by-side QOT circuit breaker in ON or OFF position | QOTHPA ^{obs} | DE2E |
| | For padlocking 2P QO-GFI circuit breakers in either ON or OFF position, fixed attachment. | GFI2PA | DE2A |
| | For 2P and 3P QO and Q1 standard circuit breakers which require padlocking in either ON or OFF position. Loose attachment Fixed attachment | QO1HPL QO1PL | DE2E DE2E |
| Handle Padlock Attachment for Padlocking in OFF position | For padlocking 2P and 3P QO circuit breakers in OFF position only, fixed attachment. | QO2PAF | DE2E |
| | For padlocking 1P QO, QO-GFI, QO-CAFI, QO-DF and QO-EPD circuit breakers in OFF position only, fixed attachment. | QOADV1PAF | DE2E |
| | For padlocking 2P QO-GFI, QO-CAFI and QO-EPD circuit breakers in OFF position only, fixed attachment. | QOGFI2PAF | DE2E |
| Ring Terminal | Ring terminals are available as a factory-installed option. | See Section 7 | DE2A |
| Sub-feed Lugs | 60 A 2P plug-on – 2 spaces required (6–2 Al/Cu) 125 A 2P plug-on – 2 spaces required (12–2/0 Al/Cu) 225 A 2P plug-on – 4 spaces required (4–300 Al/Cu) 125 A 3P plug-on – 3 spaces required (12–2/0 Al/Cu) | QO60SL ^{obs} QO2125SL QO2225SL [26] QO3125SL | DE2A DE2A DE2A DE3 |
| Mechanical Interlock Attachment | For interlocking the handles of two 2P or one 2P and one 1P QO and Q1 circuit breakers mounted side-by-side so that only one circuit breaker can be ON at a time (Not QOU) | QO2DTI | DE2E |
| With Retaining Kit | QO2DTI mechanical interlock attachment with retaining kits for securing two adjacent back-fed circuit breakers in dual power supply applications. Can be used with (2) 2Ps or (1) 2P and (1) 1P QO circuit breakers in QO816L100 load centers. | QO2DTIM | DE2E |

^{obs} This product is obsolete.



QO1PA



QO1PL



QO1HT



HLO1



QO1PAF



QO2DTI



QO1HPL



QOTHPA



QO1LO



QOHPL



QO2PAF



QOADV1PAF

Factory-Installed Accessories for QO and QOB Miniature Circuit Breakers

Factory-installed electrical accessories take up an additional pole space on QO, QO-GFI, QO-EPD, QO-SWN and QOU circuit breakers. All AC electrical accessories shown below are rated for 50/60 Hz. Accessories are not available for QOB-VH (2P 150 A and 3P 110–150 A) circuit breakers or QO, QOU molded case switches. QO circuit breakers will accept only one accessory per circuit breaker. Undervoltage trip is not available on miniature circuit breakers. Factory-installed accessories are not available for QO-AFI or

[26] Not suitable for use in 3Ø panels. Use only in 1Ø panel rated 150 A or greater.

QO-CAFI Arc Fault Circuit Breakers, QO-CAFI, QO-DF, or QO-PDF circuit breakers, or on QO2150, QO2175, or QO2200 circuit breakers.

Table 7.16: Factory-Installed Accessories for QO/QOB Circuit Breakers^[27]

| Accessory | Description | Rated Voltage | Coil Burden | Cat. No. Suffix | Accessory | Description | Contact Comb. | Max. Voltage | Max. | Cat. No. Suffix |
|------------|---|-------------------------------|---------------------------|-----------------|--------------------|--|---------------|--------------------|------------|-----------------|
| Shunt Trip | Trips the circuit breaker from a remote location by means of a trip coil energized from a separate circuit. A 120 Vac shunt trip will operate at 55% or more of rated voltage. All other shunt trips will operate at 75% or more of rated voltage. Application <ul style="list-style-type: none"> For use with momentary or maintained push button. Not available on QO-GFI, QO-EPD, QO-AFI, QO-CAFI, QO-DF, or QO-PDF. Shunt trip terminals accept (2) 0.14–0.12 AWG Cu. | 12 Vac/Vdc 24 Vac/Vdc | 60 VA 168 VA | -1042 | Auxiliary Switches | Monitors circuit breaker contact status and provides a remote signal indicating the circuit breaker contacts are OPEN or CLOSED. Application <ul style="list-style-type: none"> Auxiliary switch terminals accept (2) 14–12 AWG Cu leads. Leads (EH): Yellow for "A", Blue for "B", Striped common 18 AWG Cu. | 1A 1B | 120 Vac 120 Vac | 5 A 5 A | -1200 -1201 |
| | | 120 Vac 208 Vac 240 Vac | 72 VA 228 VA 288 VA | -1021 | Alarm Switches | Used with control circuits and is actuated only when the circuit breaker has tripped. Standard construction includes a normally-open contact. Application <ul style="list-style-type: none"> Leads: Alarm switch terminals accept (2) 14–12 AWG Cu leads. | 1A | 120 Vac | 5 A | -2100 |

QO Mounting Bases

Table 7.17: QO OEM Mounting Bases—UL Recognized Components

| Voltage System | Main Lug Rating | Spaces | Max. No. 1P Circuits | Mounting Bases Cat. No. | Main Wire Size AWG/kcmil |
|---|-----------------|--------|----------------------|-------------------------|--------------------------|
| QO Plug-On Mounting Bases—Accepts Only QO Plug-On Circuit Breakers - Not Compatible With QO Plug-On Neutral Circuit Breakers | | | | | |
| 1Ø2W 240 Vac Max. 10 k AIC (Without Neutral Assembly) | 70 A | 2 | 2 | QON2L70 | 14–4 Cu, 12–3 Al |
| | 125 A | 4 | 4 | SK9948BW | 12–1/0 Cu/Al |
| | 125 A | 6 | 6 | SK9795 | 12–1/0 Cu/Al |
| QO Plug-On Mounting Bases—Accepts Only QO Plug-On Circuit Breakers - Not Compatible With QO Plug-On Neutral Circuit Breakers | | | | | |
| 1Ø3W 240 Vac Max. 10 k AIC | 40 A | 2 | 2 | QON2L40 | 14–6 Cu, 12–6 Al |
| | 70 A | 2 | 4 | QON24L70 | 14–4 Cu, 12–3 Al |
| | 100 A | 6 | 12 | QON612L100 | 8–1/0 Cu/Al |
| | 100 A | 8 | 16 | QON816L100 | 8–1/0 Cu/Al |
| QO Plug-On Neutral Mounting Bases - Compatible with QO Plug-On Circuit Breakers and QO Plug-On Neutral Circuit Breakers | | | | | |
| 1Ø3W 240 Vac Max. 10 k AIC | 125 A | 12 | 24 | QON112L125PI | 4–2/0 Cu/Al |
| | 125 A | 20 | 24 | QON120L125PI | 4–2/0 Cu/Al |
| | 200 A | 12 | 24 | QON112L200PI | 4–250 Cu/Al |
| | 200 A | 24 | 36 | QON124L200PI | 4–250 Cu/Al |
| | 200 A | 24 | 36 | QON124L200PDL | (2) 4–300 Cu/Al |
| | 200 A | 30 | 40 | QON130L200PI | 4–250 Cu/Al |
| | 225 A | 42 | 52 | QON142L225PI | 4–300 Cu/Al |
| | 225 A | 52 | 72 | QON154L225P | 4–300 Cu/Al |
| QO Plug-On Mounting Bases—Accepts Only QO Plug-On Circuit Breakers - Not Compatible With QO Plug-On Neutral Circuit Breakers | | | | | |
| 3Ø3W 240 Vac Max. 10 k AIC (Without Neutral Assy.) | 125 A | 12 | 12 | QON312L125 | 4–2/0 Cu/Al |
| | 125 A | 20 | 20 | QON320L125 | 4–2/0 Cu/Al |
| | 125 A | 24 | 24 | QON324L125 | 4–2/0 Cu/Al |
| | 200 A | 18 | 18 | QON318L200 | 4–300 Cu/Al |
| | 200 A | 24 | 24 | QON324L200 | 4–300 Cu/Al |
| | 200 A | 30 | 30 | QON330L200 | 4–300 Cu/Al |
| | 225 A | 42 | 42 | QON342L225 | 4–300 Cu/Al |
| QO Plug-On Mounting Bases—Accepts Only QO Plug-On Circuit Breakers - Not Compatible With QO Plug-On Neutral Circuit Breakers | | | | | |
| 3Ø4W 240 Vac Max. 10 k AIC | 60 A | 3 | 3 | QON403L60N | 12–6 Cu/Al |
| | 125 A | 12 | 12 | QON312L125I | 4–2/0 Cu/Al |
| | 125 A | 20 | 20 | QON320L125I [28] | 4–2/0 Cu/Al |
| | 125 A | 24 | 24 | QON324L125I | 4–2/0 Cu/Al |
| | 200 A | 30 | 30 | QON330L200I [28] | 4–300 Cu/Al |
| QO Plug-On Mounting Bases—Accepts Only QO Plug-On Circuit Breakers - Not Compatible With QO Plug-On Neutral Circuit Breakers | | | | | |
| 1Ø2W 240 Vac Max. 10 k AIC (Without Neutral Assembly) | 70 A | 1 | 1 | QOMB1 | 14–4 Cu 12–2 Al |
| | 70 A | 2 | 2 | QOMB2 | 14–4 Cu 12–2 Al |
| | 70 A | 3 | 3 | QOMB3 | 14–4 Cu 12–2 Al |
| QOB Bolt-On Mounting Bases—Accepts only QOB Bolt-On Circuit Breakers | | | | | |
| 3Ø3W 240 Vac Max. 10 k AIC (Without Neutral Assembly) | 100 A | 3 | 3 | QON3B | 12–1 Cu/Al |

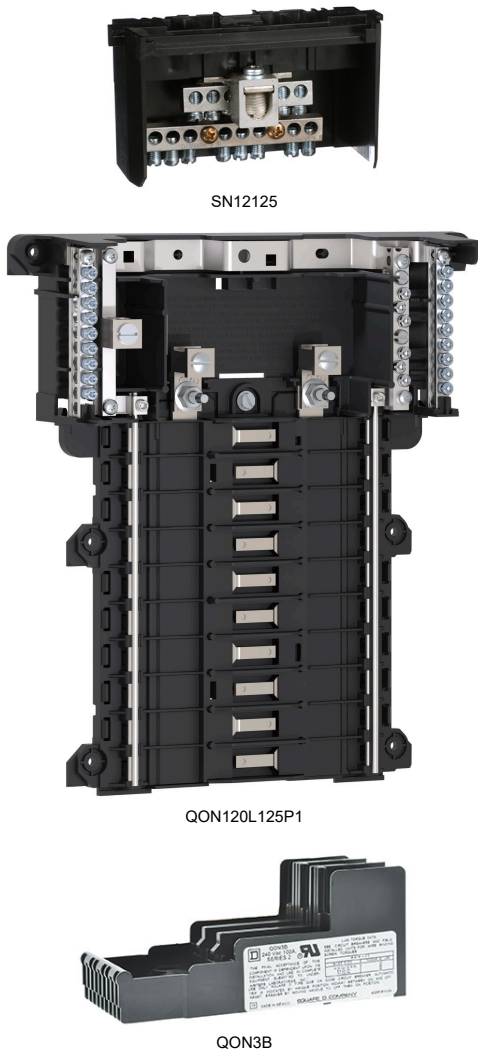

Table 7.18: Solid Neutral Assemblies

| Main Lug Rating | Number of Branch Neutral Terminals | Cat. No. | Main Neutral Lug Wire Size Cu/Al | Branch Neutral Terminal Wire Size | |
|-----------------|------------------------------------|----------|----------------------------------|-----------------------------------|----------|
| | | | | Cu | Al |
| 125 A | 12 | SN12125 | 4–2/0 AWG | 14–4 AWG | 12–4 AWG |
| 125 A | 20 | SN20 | 4–2/0 AWG | 14–4 AWG | 12–4 AWG |
| 200 A | 12 | SN12200 | 4 AWG–300 kcmil | 14–4 AWG | 12–4 AWG |
| 200 A | 30 | SN30 | 4 AWG–300 kcmil | 14–4 AWG | 12–4 AWG |
| 225 A | 42 | SN42 | 4 AWG–300 kcmil | 14–4 AWG | 12–4 AWG |

[27] QOB circuit breakers with shunt trip, auxiliary switches, and/or alarm switches, which are no longer active commercial references, may be available Factory Assembled into NQ Panelboards.

[28] Also IEC rated and CE marked for IEC 60439-1. Use only Square D brand Type QOXC, QOXD, QOHX and QOE circuit breakers for 415Y/240 Vac max. systems.

Low Ampere QOU Miniature Circuit Breakers

QOU unit mount miniature circuit breakers (cable-in/cable-out) are ideal for OEM applications. They have the Square D™ circuit breaker’s unique Visi-Trip™ feature and can be DIN rail-mounted or surface- or flush-mounted using mounting feet. Mounting feet not provided [29].

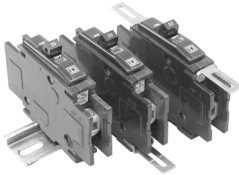

Low Ampere QOU

General Specifications Common to All Low Ampere QOU Circuit Breakers

- For convenient flush mount, surface mount or DIN mount (symmetrical rail 35 x 7.5 DIN/EN 50 022)
- Single handle with internal common trip
- Terminal lug wire size (1) 14–2 AWG Cu or Al
- Reversible line and load lugs
- Field-installable quick connectors
- UL Listed 48 Vdc (5 k AIR)
- UL Listed as HACR Type: 10–70 A
- High magnetic trip circuit breakers (QOU-HM) are recommended for applications where high initial inrush may occur and for individual dimmer applications.
- For DIN mounting rails, see IEC Starters and Relays, Section 18.

Table 7.19: QOU Low Ampere Miniature Circuit Breakers

| Ampere Rating | Cat. No. | | | |
|-----------------|-------------------------|----------------|------------------------|-------------------------|
| | 1P 120/240 Vac | 2P 120/240 Vac | 2P 240 Vac [30] | 3P 240 Vac |
| 10 k AIR | | | | |
| 10 A | QOU110 | QOU210 | — | QOU310 |
| 15 A | QOU115 | QOU215 | QOU215H | QOU315 |
| 20 A | QOU120 | QOU220 | QOU220H | QOU320 |
| 25 A | QOU125 | QOU225 | QOU225H ^{Obs} | QOU325 |
| 30 A | QOU130 | QOU230 | QOU230H | QOU330 |
| 35 A | QOU135 | QOU235 | — | QOU335 |
| 40 A | QOU140 | QOU240 | — | QOU340 |
| 45 A | QOU145 ^{Obs} | QOU245 | — | QOU345 |
| 50 A | QOU150 | QOU250 | — | QOU350 |
| 60 A | QOU160 | QOU260 | — | QOU360 |
| 70 A | QOU170 | QOU270 | — | QOU370 |
| 22 k AIR | | | | |
| 15 A | QOU115VH | QOU215VH | — | QOU315VH ^{Obs} |
| 20 A | QOU120VH | QOU220VH | — | QOU320VH |
| 30 A | QOU130VH | QOU230VH | — | QOU330VH |
| 50 A | QOU150VH ^{Obs} | QOU250VH | — | — |
| 60 A | QOU160VH | QOU260VH | — | — |

^{Obs} This product is obsolete.

Table 7.20: QOU-HM Miniature Circuit Breakers (10 k AIR)

| Ampere Rating | Cat. No. | | | |
|---------------|----------------|----------------|------------|------------|
| | 1P 120/240 Vac | 2P 120/240 Vac | 2P 240 Vac | 3P 240 Vac |
| 15 A | QOU115HM | — | — | — |
| 20 A | QOU120HM | — | — | — |

[29] See QOU Accessories, page 7-20.
[30] QOU-H interrupting rating is 10 kA at 240 Vac.



High Ampere QOU

High Ampere QOU Circuit Breakers

General Specifications Common to All High Ampere QOU Circuit Breakers

- Flush mount, surface mount, and DIN rail mount.
- Internal common trip.
- Non-reversible line and load lugs.
- Terminal lug wire size (1) 12– 2/0 AWG Cu or Al.
- UL Listed 60 Vdc per pole (5 k AIR). (**Note:** except switches)
- UL Listed as HACR type, 80–125 A.
- Non-automatic switches have the same physical packaging as miniature circuit breakers, but provide no overcurrent or short circuit protection. They are UL Listed per UL1087 and are CSA certified.

Table 7.21: QOU High Ampere Miniature Circuit Breakers (10 k AIR)

| Ampere Rating | Cat. No. | | | |
|---------------|-----------------------|----------------|------------|------------|
| | 1P 120/240 Vac | 2P 120/240 Vac | 2P 240 Vac | 3P 240 Vac |
| 80 A | QOU180 | QOU280 | — | QOU380 |
| 90 A | QOU190 ^{OBS} | QOU290 | — | QOU390 |
| 100 A | QOU1100 | QOU2100 | — | QOU3100 |
| 125 A | — | QOU2125 | — | — |

^{OBS} This product is obsolete.

Table 7.22: QOU Non-Automatic Switches

| Ampere Rating | Cat. No. | |
|---------------|------------------------|-------------------------|
| | 2P 240 Vac | 3P 240 Vac |
| 60 A | QOU200 | QOU300 |
| 100 A | QOU2000 ^{OBS} | QOU3000 ^{OBS} |
| 125 A | QOU20001 | QOU30001 ^{OBS} |

^{OBS} This product is obsolete.

Interrupting ratings see [page 7-3](#)

Accessories see [page 7-20](#)

Dimensions see [page 7-85](#)

QOU Accessories

Table 7.23: Accessories for QOU Low Ampere Circuit Breakers (Except as Noted)

| Description | Order Qty. | Cat. No. |
|--|------------|-----------------------------|
| Factory-installed ring tongue terminal, 10–32 screw, for 1P, 2P, 3P QOU, 10–60 A | — | Suffix -5283 |
| Hex drive 5/32 in. wire binding screw for QOU | — | Suffix -5280 |
| For padlocking 1P low ampere QOU circuit breaker in OFF or ON position | — | QOU1PA OBS |
| For padlocking 2P and 3P low ampere QOU circuit breaker in OFF or ON position | — | QOU1PL |
| For padlocking 1P low ampere QOU circuit breaker in OFF position only | — | QOU1PAFLA |
| For padlocking 2P and 3P low ampere QOU circuit breaker in OFF position only | — | QOU2PAFLA |
| For padlocking 2P and 3P high ampere QOU circuit breaker in OFF position only | — | Suffix -7100 |
| Handle lock-out, ON or OFF position | — | HLO1 |
| 4P 100 A Jumper bar assy. w/front wiring with base, cover and screw | 1 | QOU14100JBAF |
| 4P 100 A Jumper bar assy. w/right side wiring with base, cover and screw | 1 | QOU14100JBAR OBS |
| 4P 100 A Jumper bar assy. w/left side wiring with base, cover and screw | 1 | QOU14100JBAL |
| 1Ø, 4P, 100 A Jumper bar base with front wiring | 40 | QOU14100BAFB |
| 1Ø, 4P, 100 A Jumper bar base with left side wiring | 40 | QOU14100BALB |
| 1Ø, 4P, 100 A Jumper bar base with right side wiring | 40 | QOU14100BARB |
| 4P Jumper bar cover | 40 | QOU14100CAB |
| Mounting screw for jumper bar cover | 40 | QOU1CMSB OBS |
| 6P 150 A Jumper bar assy. w/front wiring with base, cover and screw | 1 | QOU16150JBAF |
| 1Ø, 6P, 150 A Jumper bar base with front wiring | 40 | QOU16150BAFB |
| 1Ø, 6P, 150 A Jumper bar base with left side wiring | 40 | QOU16150BALB OBS |
| 1Ø, 6P, 150 A Jumper bar base with right side wiring | 40 | QOU16150BARB OBS |
| 6P jumper bar cover | 40 | QOU16150CAB OBS |
| Vertical rainproof cover 2P and 3P QO, QOU, FA and KA | 1 10 | BCV [31] BCVB OBS |
| Horizontal rainproof cover 2P QO, QOU, and 3P Q2, EH | 1 10 | BCH [31] BCHB [31] |
| 1P Fingersafe™ cover for high ampere QOU circuit breaker | 1 40 | QOUHFSC1 QOUHFSC1B OBS |
| 1P Fingersafe cover for low ampere QOU circuit breaker | 1 40 | QOUFSC1 QOUFSC1B |
| Cover plate for one 2P QOU circuit breaker | 1 40 | QOUCP2 OBS QOUCP2B |
| Cover plate for one 3P QOU circuit breaker | 1 40 | QOUCP3 OBS QOUCP3B |
| Cover plate for two 2P QOU circuit breakers | 1 40 | QOUCP4 OBS QOUCP4B |
| Cover plate for three 2P QOU circuit breakers | 1 40 | QOUCP6 OBS QOUCP6B |
| Field-installable ring tongue terminal adaptor | 1 80 | QOURT QOURTB |
| Quick connector end connection wiring | 1 40 | QOUEC QOUECB |
| Quick connector forward or reverse wiring | 1 40 | QOUFR OBS QOUFRB |
| 1P QOU mounting foot | 1 80 | QOUMF1 [31] QOUMF1B [31] |
| 2P QOU mounting foot | 1 40 | QOUMF2 [31] QOUMF2B [31] |
| 3P QOU mounting foot | 1 24 | QOUMF3 OBS QOUMF3B [31] |
| Tapped mounting foot for QOU, 1P and 2P 10–70 A, 3P 10–60 A | | |
| Packaged with circuit breaker | | Suffix -3100 |
| Individually packaged | 1 | QOUMFS1 |
| Bulk packed | 80 | QOUMFS1B OBS |
| Mechanical interlock attachment: Used to interlock two circuit breakers mounted side-by-side so that only one circuit breaker can be ON at a time. A 1P or 2P circuit breaker can be mounted on the left and interlocked with a 2P or 3P circuit breaker on the right. | 1 | QOU2DTILA [32] |

OBS This product is obsolete.

QOUQ Low Ampere Circuit Breakers

QOUQ low ampere circuit breakers with four-point quick-connect terminals are provided with permanent factory-installed terminals which are affixed to the Load or OFF end of the circuit breaker. This special terminal will accommodate up to four 1/4-inch insulated female quick connect wire terminations. Total ampacity of these connections must not exceed the rating of the circuit breaker.

Table 7.24: QOUQ Four-Point Quick-Connect Terminals

| | Poles | Order Qty. | Cat. No. |
|------------------------------------|-------|------------|--------------------|
| Four-Point Quick-Connect Terminals | 1 | 1 | Change QOU to QOUQ |
| | 2 | 1 | |
| | 3 | 1 | |

The QOU uses the same electrical accessories as the QO. See the QO information for available electrical accessories.



QOU14100JBAF

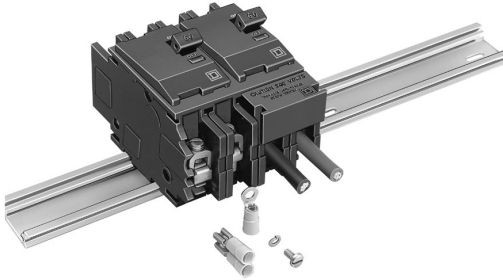

2P DIN-Mounted QOU Circuit Breaker

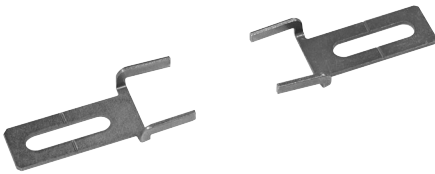

Mounting Foot
QOUMF1

[31] For use on low and high ampere QOU.
[32] 10–70 A 1P and 2P, 10–60 A 3P.



HOM 1P and 2P



HOM2200BB Branch Circuit Breaker
4 Spaces Required

Homeline Standard Plug-On Circuit Breakers

The Square D Homeline circuit breakers are in a 1 in. wide format for 1-pole circuit breakers. They are designed to plug into Homeline load centers.

Table 7.25: Standard HOM Plug-on Circuit Breakers

| Ampere Rating | AIR | 1P—120 Vac, 1 Space Required | 2P—120/240 Vac Common Trip 2 Spaces Required. |
|---------------|-------|---------------------------------|--|
| 15 A | 10 kA | HOM115 [1][2] | HOM215 [2] |
| 20 A | 10 kA | HOM120 [1][2] | HOM220 [2] |
| 25 A | 10 kA | HOM125 [2] | HOM225 [2] |
| 30 A | 10 kA | HOM130 [2] | HOM230 [2] |
| 35 A | 10 kA | — | HOM235 [2] |
| 40 A | 10 kA | HOM140 [2] | HOM240 [2] |
| 45 A | 10 kA | — | HOM245 [2] |
| 50 A | 10 kA | HOM150 [2] | HOM250 [2] |
| 60 A | 10 kA | — | HOM260 [2] |
| 70 A | 10 kA | — | HOM270 [2] |
| 80 A | 10 kA | — | HOM280 [2] |
| 90 A | 10 kA | — | HOM290 [2] |
| 100 A | 10 kA | — | HOM2100 [2] |
| 110 A | 10 kA | — | HOM2110 [2] |
| 125 A | 10 kA | — | HOM2125 [2] |
| 150 A | 10 kA | — | HOM2150BB [2][3] |
| 175 A | 10 kA | — | HOM2175BB [2][3] |
| 200 A | 10 kA | — | HOM2200BB [2][3] |

Homeline High Magnetic Circuit Breakers (HOM-HM)

High magnetic trip circuit breakers are recommended for applications where high initial inrush current may occur.

Table 7.26: HOM-HM Circuit Breakers

| Amperes | 1P—120/240 Vac | 2Ps |
|---------|----------------|-----|
| 20 A | HOM120HM [4] | — |

Homeline Combination Arc Fault Circuit Interrupters (HOM-CAFI)

Homeline Combination Arc Fault Circuit Interrupters—Provide overload and short circuit protection, plus arc fault protection in accordance with the NEC and UL1699.

Table 7.27: HOM-CAFI Circuit Breakers

| Circuit Breaker Type | Ampere Rating | Poles 120 Vac | Cat. No. |
|--|---------------|------------------|--------------------|
| One-Pole | | | |
| Combination Arc-Fault Circuit Interrupter with Pigtail Neutral | 15 A | 1 | HOM115CAFI [4] |
| | 20 A | 1 | HOM120CAFI [4] |
| Plug-On Neutral Combination Arc-Fault Interrupter | 15 A | 1 | HOM115PCAIFI [4] |
| | 20 A | 1 | HOM120PCAIFI [4] |
| Two-Pole | | | |
| Combination Arc-Fault Circuit Interrupter with Pigtail Neutral | 15 A | 2 | HOM215CAFI [4] [5] |
| | 20 A | 2 | HOM220CAFI [4] [5] |



HOM 1P CAFE
Plug-on Neutral



HOM 1P CAFE
Pigtail



HOM 1P DF
Plug-on Neutral



HOM 1P DF
Pigtail

Homeline Dual Function Circuit Breaker (HOM-DF)

Homeline Combination Arc Fault and Ground Fault Circuit Interrupters (Dual Function)—Provide overload and short circuit protection, plus arc fault and ground fault protection in a single device in accordance with the NEC, UL1699 and UL943.

Table 7.28: HOM-DF Circuit Breakers

| Circuit Breaker Type | Ampere Rating | Poles 120 Vac | Cat. No. |
|---|---------------|------------------|---------------|
| Combination Arc-Fault and Ground Fault Circuit Interrupter with Pigtail Neutral | 15 A | 1 | HOM115DF [4] |
| | 20 A | 1 | HOM120DF [4] |
| Plug-On Neutral Combination Arc-Fault and Ground Fault Circuit Interrupter | 15 A | 1 | HOM115PDF [4] |
| | 20 A | 1 | HOM120PDF [4] |

[1] UL Listed as SWD (switching duty) rated. Suitable for switching 120 Vac fluorescent lighting loads.

[2] UL Listed as HACR type for use with air conditioning, heating and refrigeration equipment having motor group combinations and marked for use with HACR type circuit breakers.

[3] Requires four spaces (1 AWG—300 kcmil Al/Cu). Use only in 1Ø panel rated 150 A or greater.

[4] UL Listed as HACR type for use with air conditioning, heating and refrigeration equipment having motor group combinations and marked for use with HACR type circuit breakers.

[5] For 120/240 V only, not for 208Y/120 V.



HOM 1P GFI
(With Ground Fault
Circuit Interrupter)
1 Space Required



HOM 2P GFI
(With Ground Fault
Circuit Interrupter)
2 Spaces Required

Homeline Ground-Fault Circuit Breaker (HOM-GFI)

HOM-GFI circuit breakers provide overload and short circuit protection, combined with Class A ground fault protection. Class A denotes a ground fault circuit interrupter that will trip when a fault current to ground is 6 milliamperes or more.

Table 7.29: HOM-GFI Circuit Breakers

| Circuit Breaker Type | Ampere Rating | AIR | 1P—120 Vac 1 Space Required | 2P—120/240 Vac Common Trip 2 Spaces Required |
|--|---------------|-------|--------------------------------|--|
| Ground-Fault Circuit Interrupter (Pigtail Neutral) | 15 A | 10 kA | HOM115GFI | HOM215GFI |
| | 20 A | 10 kA | HOM120GFI | HOM220GFI |
| | 25 A | 10 kA | — | HOM225GFI |
| | 30 A | 10 kA | — | HOM230GFI |
| | 35 A | 10 kA | — | HOM235GFI |
| | 40 A | 10 kA | — | HOM240GFI |
| | 45 A | 10 kA | — | HOM245GFI |
| Plug-On Neutral Ground-Fault Circuit Interrupter | 50 A | 10 kA | — | HOM250GFI |
| | 15 A | 10 kA | HOM115PGFI | — |
| | 20 A | 10 kA | HOM120PGFI | — |

Homeline Equipment Protection Device (HOM-EPD)

Homeline Equipment Protection Device—Circuit Breakers with 30 mA Equipment Ground Fault Protection (UL Listed).

Table 7.30: HOM-EPD Circuit Breakers

| Amperes | 1P—120 Vac | 2P—120/240 Vac Common Trip |
|---------|------------|-------------------------------|
| 20 A | HOM120EPD | HOM220EPD |
| 30 A | — | HOM230EPD |
| 40 A | — | HOM240EPD |
| 50 A | — | HOM250EPD |

Homeline Tandem and Quad Tandem Circuit Breakers (HOMT)

Table 7.31: HOMT Tandem Circuit Breakers



HOMT Tandem
Circuit Breaker

| Ampere Rating [6] | AIR | 1P Tandem—120/240 Vac (One Space Required) |
|-------------------|-------|--|
| 15 and 15 A | 10 kA | HOMT1515 [7] |
| 15 and 20 A | 10 kA | HOMT1520 [7] |
| 20 and 20 A | 10 kA | HOMT2020 [7] |
| 30 and 15 A | 10 kA | HOMT3015 [7] |
| 30 and 20 A | 10 kA | HOMT3020 [7] |

Table 7.32: HOMT Quad Tandem 1P Circuit Breakers



HOMT1515215
2 Spaces Required

| Ampere Rating [6] | | AIR | 2P Tandem—120/240 Vac (Two Spaces Required) |
|-------------------|------|-------|--|
| 1P | 2P | | |
| (2) 15 A | 15 A | 10 kA | HOMT1515215 |
| (2) 15 A | 20 A | 10 kA | HOMT1515220 |
| (2) 15 A | 30 A | 10 kA | HOMT1515230 |
| (2) 15 A | 40 A | 10 kA | HOMT1515240 |
| (2) 15 A | 50 A | 10 kA | HOMT1515250 |
| (2) 20 A | 20 A | 10 kA | HOMT2020220 |
| (2) 20 A | 25 A | 10 kA | HOMT2020225 |
| (2) 20 A | 30 A | 10 kA | HOMT2020230 |
| (2) 20 A | 40 A | 10 kA | HOMT2020240 |
| (2) 20 A | 50 A | 10 kA | HOMT2020250 |

NOTE: Typical catalog no. (e.g. HOMT 1515230) represents two 1P, outer poles (two 15 A 1P CBs) and one 2P inner circuit breaker with common trip (one 30 A 2P CB).

Table 7.33: HOMT Quad Tandem 2P Circuit Breakers



HOMT225225
2 Spaces Required

| Ampere Rating [6] | | AIR | (2) 2P Tandem—120/240 Vac (Two Spaces Required) |
|-------------------|------|-------|--|
| 2P | 2P | | |
| 15 A | 15 A | 10 kA | HOMT215215 |
| 15 A | 20 A | 10 kA | HOMT215220 |
| 15 A | 25 A | 10 kA | HOMT215225 |
| 15 A | 30 A | 10 kA | HOMT215230 |
| 15 A | 40 A | 10 kA | HOMT215240 |
| 15 A | 50 A | 10 kA | HOMT215250 |
| 20 A | 20 A | 10 kA | HOMT220220 |
| 20 A | 25 A | 10 kA | HOMT220225 |
| 20 A | 30 A | 10 kA | HOMT220230 |
| 20 A | 40 A | 10 kA | HOMT220240 |
| 20 A | 50 A | 10 kA | HOMT220250 |
| 25 A | 25 A | 10 kA | HOMT225225 |
| 25 A | 30 A | 10 kA | HOMT225230 |
| 25 A | 40 A | 10 kA | HOMT225240 |

[6] 15–20 A tandem or quad tandem circuit breakers are suitable for use with 60°C or 75°C conductors. 25–50 A tandem or quad tandem circuit breakers are suitable for use with 75°C conductors only.

[7] UL Listed as HACR type for use with air conditioning, heating and refrigeration equipment having motor group combinations and marked for use with HACR type circuit breakers.

Table 7.33 HOMT Quad Tandem 2P Circuit Breakers (cont'd.)

| Ampere Rating [8] | | AIR | (2) 2P Tandem—120/240 Vac (Two Spaces Required) |
|-------------------|------|-------|--|
| 2P | 2P | | |
| 25 A | 50 A | 10 kA | HOMT225250 |
| 30 A | 30 A | 10 kA | HOMT230230 |
| 30 A | 40 A | 10 kA | HOMT230240 |
| 30 A | 50 A | 10 kA | HOMT230250 |

NOTE: Typical catalog no. (i.e. HOMT215230) represents two 2P; outer poles (one 15 A 2P with common trip) and inner poles (one 30 A 2P with common trip).

Homeline Circuit Breaker Wire Sizes

Table 7.34: Wire Sizes for Homeline Circuit Breakers

| Breaker Type | Ampere Rating | Wire Size (AWG/kcmil) [9] | |
|---------------|---------------|---------------------------|------------------------------|
| | | Aluminum | Copper |
| HOM 1P | 15–30 A | 14–8 AWG | 14–8 AWG or (2) 14–10 AWG |
| | 40–50 A | 8–2 AWG | 8–2 AWG |
| HOM 2P | 15–30 A | 14–8 AWG | 14–8 AWG or (2) 14–10 AWG |
| | 35–70 A | 8–2 AWG | 8–2 AWG |
| | 80–125 A | 4–2/0 AWG | 4–2/0 AWG |
| | 150–200 A | 4 AWG–300 kcmil | 4 AWG–300 kcmil |
| HOMT and Quad | 15–30 A | 14–8 AWG | 14–8 AWG |
| Quad Only | 40–50 A | 6–12 AWG | 6–14 AWG |
| HOM-GFI - 1P | 15–20 A | 14–10 AWG | 14–10 AWG |
| HOM-GFI - 2P | 15–50 A | 12–4 AWG | 14–6 AWG |

Accessories for Homeline Circuit Breakers

Table 7.35: Accessories for Use with Homeline Circuit Breakers

| Description | Cat. No. | |
|---|---------------|-------------|
| Handle Attachments | | |
| Handle Tie: Converts any two adjacent 120/240 Vac single HOM circuit breakers to independent trip 2P | HOM1HT | |
| Handle Tie: Converts any two adjacent 120/240 Vac 1P side-by-side HOMT circuit breakers to independent trip 2P | HOMTHT | |
| Handle Clamp: Clamp for holding HOM 1P handle in the ON or OFF position | QO1LO | |
| Handle Blocking Device: Attaches to standard HOM 2P circuit breakers for holding the handle in the OFF position | HOM2HBD | |
| Handle Padlock Attachment: For padlocking 1P Standard HOM breakers in the ON or OFF position | HOM1PA | |
| Handle Padlock Attachment: For padlocking 2P Standard HOM circuit breakers in ON or OFF position | 15–70 A | HOM2PALA |
| | 80–125 A | HOM2PAHA |
| Handle Padlock Attachment: For padlocking 1P CAFI, DF, GFI, and EPD HOM breakers in ON or OFF position | HOMELEC1PA | |
| Handle Padlock Attachment: For padlocking 2P CAFI, GFI, and EPD HOM breakers in ON or OFF position | HOMELEC2PALA | |
| Handle Padlock Attachment: For padlocking center poles of Homeline Quad breakers in the OFF position | HOMQPA | |
| Handle Padlock Attachment: For padlocking main circuit breakers in convertible load center in OFF position | 50–125 A | QOM1PA [10] |
| | 100–225 A | QOM2PA [10] |
| Sub-Feed Lugs | | |
| 125 A 2P plug-on—2 spaces required | HOML2125 | |
| 225 A 2P plug-on—4 spaces required | HOML2225 [11] | |

^{oBS} This product is obsolete.

[8] 15–20 A tandem or quad tandem circuit breakers are suitable for use with 60°C or 75°C conductors. 25–50 A tandem or quad tandem circuit breakers are suitable for use with 75°C conductors only.
 [9] 15–30 A circuit breakers are suitable for use with 60°C or 75°C conductors. 40–125 A circuit breakers are suitable for use with 75°C conductors.
 [10] 50–125 A QOM1 frame size; 100–225 A QOM2 frame size.
 [11] Requires four spaces (1 AWG–300 kcmil Al/Cu). Use only in 1Ø panel rated 150 A or greater.



UL489 / CSA C22.2 No 5 / IEC/EN 60947-2 / GB14048-2
Miniature Circuit Breakers

Multi9 C60_{BP} and C60_{BPR} Miniature Circuit Breakers

C60_{BP} and C60_{BPR} are multi-standard miniature circuit breakers and branch circuit protection as defined by UL489. They combine the following functions:

- circuit protection against short-circuit curves
- circuit protection against overload currents
- tripping and fault indication by the addition of auxiliary accessories

| Number of 18 mm (0.71 in.) Poles | Rating (A) 25°C/77°F | Breaking Capacity (kA rms) | | | | | | | |
|---|-------------------------|----------------------------|---------|---------|---------|-------------|---------|---------|---------|
| | | UL 489 / CSA C22.2 No 5 | | | | IEC 60947-2 | | | |
| | | AIR | | | | Icu | | | |
| | Voltage (Ue) | 277 Vac | 240 Vac | 120 Vac | 60 Vdc | 440 Vac | 415 Vac | 240 Vac | 60 Vdc |
| 1P | 0.5 to 35 | 10 | 14 | 14 | 10 | — | 3 | 10 | 20 |
| | 40 to 63 | — | 10 | 10 | 10 | — | 3 | 10 | 20 |
| | Voltage (Ue) | 480Y/277 Vac | | 240 Vac | 125 Vdc | 440 Vac | 415 Vac | 240 Vac | 125 Vdc |
| 2P | 1 to 25 | 10 | | 14 | 10 | 6 | 10 | 20 | — |
| | 30 to 35 | 10 | | 14 | — | 6 | 10 | 20 | — |
| 3P | 1 to 35 | 10 | | 14 | — | 6 | 10 | 20 | — |
| 2P/3P | 40 to 63 | — | | 10 | — | 6 | 10 | 20 | — |

Table 7.36: C60_{BP} and C60_{BPR} Catalog Numbers

| Type Rating (In) | UL489 and CSA Voltages | 1P | | 2P | | 3P | | |
|--|------------------------------|----------|----------|----------|----------|----------|----------|----------|
| | | Curve | | Curve | | Curve | | |
| | | Z | C | D (= K) | C | D (= K) | C | D (= K) |
| C60_{BP} (Tunnel Terminal Connection) | | | | | | | | |
| 0.5 | 480Y/277 V and 240 V | M9F44170 | M9F42170 | M9F43170 | — | — | — | |
| 1 | | M9F44101 | M9F42101 | M9F43101 | M9F42201 | M9F43201 | M9F42301 | M9F43301 |
| 2 | | M9F44102 | M9F42102 | M9F43102 | M9F42202 | M9F43202 | M9F42302 | M9F43302 |
| 3 | | M9F44103 | M9F42103 | M9F43103 | M9F42203 | M9F43203 | M9F42303 | M9F43303 |
| 4 | | M9F44104 | M9F42104 | M9F43104 | M9F42204 | M9F43204 | M9F42304 | M9F43304 |
| 5 | | M9F44105 | M9F42105 | M9F43105 | M9F42205 | M9F43205 | M9F42305 | M9F43305 |
| 6 | | M9F44106 | M9F42106 | M9F43106 | M9F42206 | M9F43206 | M9F42306 | M9F43306 |
| 8 | | M9F44108 | M9F42108 | M9F43108 | M9F42208 | M9F43208 | M9F42308 | M9F43308 |
| 10 | | M9F44110 | M9F42110 | M9F43110 | M9F42210 | M9F43210 | M9F42310 | M9F43310 |
| 15 | | M9F44115 | M9F42115 | M9F43115 | M9F42215 | M9F43215 | M9F42315 | M9F43315 |
| 20 | | M9F44120 | M9F42120 | M9F43120 | M9F42220 | M9F43220 | M9F42320 | M9F43320 |
| 25 | | M9F44125 | M9F42125 | M9F43125 | M9F42225 | M9F43225 | M9F42325 | M9F43325 |
| 30 | | M9F44130 | M9F42130 | M9F43130 | M9F42230 | M9F43230 | M9F42330 | M9F43330 |
| 35 | | M9F44135 | M9F42135 | M9F43135 | M9F42235 | M9F43235 | M9F42335 | M9F43335 |
| 40 | | M9F44140 | M9F42140 | M9F43140 | M9F42240 | M9F43240 | M9F42340 | M9F43340 |
| 45 | | M9F44145 | M9F42145 | M9F43145 | M9F42245 | M9F43245 | M9F42345 | M9F43345 |
| 50 | | M9F44150 | M9F42150 | M9F43150 | M9F42250 | M9F43250 | M9F42350 | M9F43350 |
| 63 | M9F44163 | M9F42163 | M9F43163 | M9F42263 | M9F43263 | M9F42363 | M9F43363 | |
| C60_{BPR} (Ring Tongue Terminal Connection) | | | | | | | | |
| 1 | 480Y/277 V and 240 V | M9F54101 | M9F52101 | M9F53101 | M9F52201 | M9F53201 | M9F52301 | M9F53301 |
| 2 | | M9F54102 | M9F52102 | M9F53102 | M9F52202 | M9F53202 | M9F52302 | M9F53302 |
| 4 | | M9F54104 | M9F52104 | M9F53104 | M9F52204 | M9F53204 | M9F52304 | M9F53304 |
| 6 | | M9F54106 | M9F52106 | M9F53106 | M9F52206 | M9F53206 | M9F52306 | M9F53306 |
| 8 | | M9F54108 | M9F52108 | M9F53108 | M9F52208 | M9F53208 | M9F52308 | M9F53308 |
| 10 | | M9F54110 | M9F52110 | M9F53110 | M9F52210 | M9F53210 | M9F52310 | M9F53310 |
| 15 | | M9F54115 | M9F52115 | M9F53115 | M9F52215 | M9F53215 | M9F52315 | M9F53315 |
| 20 | | M9F54120 | M9F52120 | M9F53120 | M9F52220 | M9F53220 | M9F52320 | M9F53320 |
| 25 | | M9F54125 | M9F52125 | M9F53125 | M9F52225 | M9F53225 | M9F52325 | M9F53325 |
| 30 | | M9F54130 | M9F52130 | M9F53130 | M9F52230 | M9F53230 | M9F52330 | M9F53330 |
| 35 | | M9F54135 | M9F52135 | M9F53135 | M9F52235 | M9F53235 | M9F52335 | M9F53335 |
| 40 | | M9F54140 | M9F52140 | M9F53140 | M9F52240 | M9F53240 | M9F52340 | M9F53340 |
| 45 | | M9F54145 | M9F52145 | M9F53145 | M9F52245 | M9F53245 | M9F52345 | M9F53345 |
| 50 | | M9F54150 | M9F52150 | M9F53150 | M9F52250 | M9F53250 | M9F52350 | M9F53350 |
| 63 | | M9F54163 | M9F52163 | M9F53163 | M9F52263 | M9F53263 | M9F52363 | M9F53363 |



C60_{BP} 1P



C60_{BP} 2P



C60_{BP} 3P



C60_{BPR} 1P



C60_{BPR} 2P



C60_{BPR} 3P



UL1077 / CSA C22.2 No 235 / IEC/EN 60947-2 / GB14048-2
Multi9 Miniature Circuit Breaker

Multi9 C60_{SP} Miniature Circuit Breakers

C60_{SP} circuit breakers are multi-standard miniature circuit breakers and supplementary protection as defined by UL1077. They combine the following functions:

- circuit protection against short-circuit curves
- circuit protection against overload currents
- tripping and fault indication by the addition of auxiliary accessories

| Number of 18 mm (0.71 in.) Poles | Rating (A) 25°C/77°F | Breaking capacity (kA rms) | | | | | | | |
|----------------------------------|----------------------|-------------------------------|--------|---------|---------|-----------------|---------|---------|---------|
| | | AIR UL 489 / CSA C22.2 No 235 | | | | Icu IEC 60947-2 | | | |
| | | 277 Vac | 240 ac | 120 Vac | 65 Vdc | 440 Vac | 415 Vac | 240 Vac | 60 Vdc |
| 1P | Voltage (Ue) | 277 Vac | 240 ac | 120 Vac | 65 Vdc | 440 Vac | 415 Vac | 240 Vac | 60 Vdc |
| | 0.5 to 32 | 10 | 14 | 14 | 10 | — | 3 | 10 | 20 |
| | 40 to 63 | 5 | 10 | 10 | 10 | — | 3 | 10 | 20 |
| 2P | Voltage (Ue) | 480Y/277 Vac | | 240 Vac | 125 Vdc | 440 Vac | 415 Vac | 240 Vac | 125 Vdc |
| | 1 to 25 | 10 | | 14 | 10 | 6 | 10 | 20 | — |
| | 32 | 10 | | 14 | — | 6 | 10 | 20 | — |
| 3P/4P | 2 to 32 | 10 | | 14 | — | 6 | 10 | 20 | — |
| 2P/3P/4P | 40 to 63 | 5 | | 10 | — | 6 | 10 | 20 | — |

Table 7.37: C60_{SP} Catalog Numbers

| Rating (In) | Tunnel Terminal Connection | | | | | |
|-------------|----------------------------|----------|----------|----------|----------|----------|
| | Curve | | | Curve | | |
| | B | C | D (= K) | B | C | D (= K) |
| | 1P | | | 2P | | |
| 0.5 | M9F21170 | M9F22170 | M9F23170 | — | — | — |
| 1 | M9F21101 | M9F22101 | M9F23101 | M9F21201 | M9F22201 | M9F23201 |
| 2 | M9F21102 | M9F22102 | M9F23102 | M9F21202 | M9F22202 | M9F23202 |
| 3 | M9F21103 | M9F22103 | M9F23103 | M9F21203 | M9F22203 | M9F23203 |
| 4 | M9F21104 | M9F22104 | M9F23104 | M9F21204 | M9F22204 | M9F23204 |
| 5 | M9F21105 | M9F22105 | M9F23105 | M9F21205 | M9F22205 | M9F23205 |
| 6 | M9F21106 | M9F22106 | M9F23106 | M9F21206 | M9F22206 | M9F23206 |
| 8 | M9F21108 | M9F22108 | M9F23108 | M9F21208 | M9F22208 | M9F23208 |
| 10 | M9F21110 | M9F22110 | M9F23110 | M9F21210 | M9F22210 | M9F23210 |
| 13 | M9F21113 | M9F22113 | M9F23113 | M9F21213 | M9F22213 | M9F23213 |
| 16 | M9F21116 | M9F22116 | M9F23116 | M9F21216 | M9F22216 | M9F23216 |
| 20 | M9F21120 | M9F22120 | M9F23120 | M9F21220 | M9F22220 | M9F23220 |
| 25 | M9F21125 | M9F22125 | M9F23125 | M9F21225 | M9F22225 | M9F23225 |
| 32 | M9F21132 | M9F22132 | M9F23132 | M9F21232 | M9F22232 | M9F23232 |
| 40 | M9F21140 | M9F22140 | M9F23140 | M9F21240 | M9F22240 | M9F23240 |
| 45 | M9F21145 | M9F22145 | M9F23145 | M9F21245 | M9F22245 | M9F23245 |
| 50 | M9F21150 | M9F22150 | M9F23150 | M9F21250 | M9F22250 | M9F23250 |
| 63 | M9F21163 | M9F22163 | M9F23163 | M9F21263 | M9F22263 | M9F23263 |
| | 3P | | | 4P | | |
| 0.5 | — | — | — | — | — | — |
| 1 | — | — | — | — | — | — |
| 2 | M9F21302 | M9F22302 | M9F23302 | M9F21402 | M9F22402 | M9F23402 |
| 3 | — | — | — | — | — | — |
| 4 | — | — | — | — | — | — |
| 5 | — | — | — | — | — | — |
| 6 | M9F21306 | M9F22306 | M9F23306 | M9F21406 | M9F22406 | M9F23406 |
| 8 | M9F21308 | M9F22308 | M9F23308 | M9F21408 | M9F22408 | M9F23408 |
| 10 | M9F21310 | M9F22310 | M9F23310 | M9F21410 | M9F22410 | M9F23410 |
| 13 | M9F21313 | M9F22313 | M9F23313 | M9F21413 | M9F22413 | M9F23413 |
| 16 | M9F21316 | M9F22316 | M9F23316 | M9F21416 | M9F22416 | M9F23416 |
| 20 | M9F21320 | M9F22320 | M9F23320 | M9F21420 | M9F22420 | M9F23420 |
| 25 | M9F21325 | M9F22325 | M9F23325 | M9F21425 | M9F22425 | M9F23425 |
| 32 | M9F21332 | M9F22332 | M9F23332 | M9F21432 | M9F22432 | M9F23432 |
| 40 | M9F21340 | M9F22340 | M9F23340 | M9F21440 | M9F22440 | M9F23440 |
| 45 | M9F21345 | M9F22345 | M9F23345 | M9F21445 | M9F22445 | M9F23445 |
| 50 | M9F21350 | M9F22350 | M9F23350 | M9F21450 | M9F22450 | M9F23450 |
| 63 | M9F21363 | M9F22363 | M9F23363 | M9F21463 | M9F22463 | M9F23463 |



C60_{SP} 1P



C60_{SP} 2P



C60_{SP} 3P



C60_{SP} 4P



UL 1077, IEC/EN 60947-2, GB14048.2
Multi9 Miniature Circuit Breakers

Multi9 C60_{H-DC} Miniature Circuit Breakers for DC Circuits

C60_{H-DC} circuit breakers are multi-standard miniature circuit breakers and supplementary protection as defined by UL1077, dedicated to direct current applications. They combine the following functions:

- circuit protection against short-circuit curves
- circuit protection against overload currents
- tripping and fault indication by the addition of auxiliary accessories

| Number of 18 mm (0.71 in.) Poles | Rating (A) 25°C/77°F | Breaking capacity (kA rms) | | | |
|----------------------------------|----------------------|----------------------------|---------|-----------------|-----------------|
| | | AIR UL 1077SA C22.2 No 5 | | Icu IEC 60947-2 | |
| Voltage (Ue) | | 12–250 Vdc | 110 Vdc | 220 Vdc | 250 Vdc |
| 1P | 0.5 to 63 | 5 | 20 | 10 | 6 |
| Voltage (Ue) | | 12–250 Vdc | — | 220 Vdc | 440 Vdc 500 Vdc |
| 2 | 0.5 to 63 | 5 | — | 20 | 10 6 |

Table 7.38: C60_{H-DC} Catalog Numbers

| Rating (In) | Curve | | | Curve | | |
|-------------|----------|----------|----------|----------|----------|----------|
| | B | C | K (= D) | B | C | K (= D) |
| | 1P | | | 2P | | |
| 0.5 | — | M9U21170 | — | — | M9U21270 | — |
| 1 | — | M9U21101 | M9U31101 | — | M9U31201 | M9U31201 |
| 2 | — | M9U21102 | M9U31102 | — | M9U21202 | M9U31202 |
| 3 | — | M9U21103 | M9U31103 | — | M9U21203 | M9U31203 |
| 4 | — | M9U21104 | M9U31104 | — | M9U21204 | M9U31204 |
| 6 | M9U11106 | M9U21106 | M9U31106 | M9U11206 | M9U21206 | M9U31206 |
| 10 | M9U11110 | M9U21110 | M9U31110 | M9U11210 | M9U21210 | M9U31210 |
| 13 | M9U11113 | M9U21113 | M9U31113 | M9U11213 | M9U21213 | M9U31213 |
| 16 | M9U11116 | M9U21116 | M9U31116 | M9U11216 | M9U21216 | M9U31216 |
| 20 | M9U11120 | M9U21120 | M9U31120 | M9U11220 | M9U21220 | M9U31220 |
| 25 | M9U11125 | M9U21125 | M9U31125 | M9U11225 | M9U21225 | M9U31225 |
| 32 | M9U11132 | M9U21132 | M9U31132 | M9U11232 | M9U21232 | M9U31232 |
| 40 | M9U11140 | M9U21140 | M9U31140 | M9U11240 | M9U21240 | M9U31240 |
| 50 | M9U11150 | M9U21150 | M9U31150 | M9U11250 | M9U21250 | M9U31250 |
| 63 | M9U11163 | M9U21163 | M9U31163 | M9U11263 | M9U21263 | M9U31263 |



C60_{H-DC} 1P



C60_{H-DC} 2P

Multi9 GFP Ground Fault Protectors

UL 1053 residual current circuit breakers already protected upstream by a short circuit and overload protection device are used for:

- control and disconnection of electric circuits
- protection of people against electric shock by direct and indirect contacts
- protection of installations against insulation faults
- enhanced continuity of supply, during a series of close lightning strokes, IT earthing system, equipment including interference suppression filters, variable speed controllers, frequency converters, electronic ballasts for lighting
- enhanced earth leakage protection: in presence of harmonics or high frequency ejections.

A-SI type GFPs are ideal for operation in environments with a humid atmosphere and/or polluted by aggressive agents: swimming pools, marinas, agri-food industries, water treatment stations, industrial sites, etc.



UL 1053, IEC/EN 61008
Multi9 Ground Fault Protectors

Table 7.39: GFP UL 1053 Type A-SI

| A-S1 Type | Rating (A) | Sensitivity (mA) | | Catalog No | | Width in modules of 9 mm (0.354 in.) |
|-----------|------------|------------------|--------------|---------------------------|---------------------------------------|--------------------------------------|
| | | UL 1053 | IEC/EN 61008 | 120 or 240 V 230 or 240 V | 240 V 480V/277 V 230/400 or 240/415 V | |
| | 25 | 26 | 30 | M9R81225 | M9R41225 | 4 |
| | | 86 | 100 | M9R12225 | M9R44225 | |
| | | 260 | 300 | M9R84225 | — | |
| | 40 | 26 | 30 | M9R81240 | M9R41240 | |
| | | 260 | 300 | M9R84240 | — | |
| | 63 | 26 | 30 | M9R81263 | — | |
| | 25 | 26 | 30 | — | M9R81425 | 8 |
| | | 86 | 100 | — | M9R12425 | |
| | | 260 | 300 | — | M9R84425 | |
| | 40 | 26 | 30 | — | M9R81440 | |
| | | 260 | 300 | — | M9R84440 | |
| | 63 | 26 | 30 | — | M9R81463 | |
| | | 86 | 100 | — | M9R12463 | |
| | 100 | 86 | 100 | — | M9R12491 | |
| | | 260 | 300 | — | M9R84491 | |



Multi9 GFP 2P



Multi9 GFP 4P



C60_{BP} (UL489) Comb Busbars

These comb busbars are aimed to be used only with C60_{BP} circuit-breakers.

They perform distribution and subdistribution of the electric power supply and allow rapid assembly and disassembly of equipment.

Table 7.40: C60_{BP} Comb Busbars

| Connection Accessories | Comb Busbars | | | | | | Insulated Connectors | Tooth Covers | End-Piece | |
|--|---|----------|----------|----------|----------|----------|--|--|--|---|
| Function | <ul style="list-style-type: none"> The comb busbars make it easier to install C60_{BP} UL489 circuit breakers. They must not be cut. | | | | | | <ul style="list-style-type: none"> Comb busbar power supply Vertical incoming feeder | <ul style="list-style-type: none"> Insulation of teeth remaining free | <ul style="list-style-type: none"> Ensures the correct comb busbar insulation | |
| Use | Power supply by insulated connector <ul style="list-style-type: none"> Use with rigid and flexible copper cable 6 to 35 mm² (AWG #10 to #2): | | | | | | Tightening torque: 3.5 N•m (31 lb.in.) | | | |
| Standard Comb Busbars | | | | | | | | | | |
| | | | | | | | | | | |
| Number of poles | 1P | | 2P | | | 3P | | All | All | — |
| Catalogue numbers | M9XUP106 | M9XUP312 | M9XUP312 | M9XUP312 | M9XUP312 | M9R81425 | M9XUPC04 | M9XCTC18 | — | |
| Number of 18 mm modules | 6 | 12 | 6 | 12 | 6 | 12 | — | — | — | |
| Set of | 1 | 1 | 1 | 1 | 1 | 1 | 4 | 5 x 3 | — | |
| Cuttable Comb Busbars | | | | | | | | | | |
| | | | | | | | | | | |
| Number of poles x | 1P | 2P | 3P | 1P+Aux | 3P+Aux | | All | All | — | |
| Catalogue numbers | M9XCP157 | M9XCP256 | M9XCP357 | M9XCA137 | M9XCA348 | | M9XCPC04 | M9XUTC18 | M9XCEC10 | |
| Number of 18 mm modules | 57 | 56 | 57 | 37 | 37 | | — | — | — | |
| Set of | 1 | 1 | 1 | 1 | 1 | | 4 | 5 x 3 | — | |
| Technical Specifications | | | | | | | | | | |
| Acceptable current at 40°C (I _e) | Standard comb busbars: 115 A Cuttable comb busbars: 80 A | | | | | | | | | |
| Resistance to short-circuit currents | Compatible with the breaking capacity of Schneider Electric modular circuit breakers | | | | | | | | | |
| Voltage rating (U _e) | 480Y/277 V | | | | | | | | | |
| Insulation voltage (U _i) | 1000 V AC | | | | | | | | | |
| Pollution degree | 3 | | | | | | | | | |
| Fire resistance | Self-extinguishability 960°C 30 s/30 s | | | | | | | | | |
| Colour | RAL 7035 | | | | | | | | | |
| Standards | UL508 | | | | | | | | | |





C60^{SP} (UL1077) Comb Busbars

The comb busbars are used only for C60^{SP} circuit breakers UL 1077 supplementary protection in conformity with standards:

- UL 1077 / CSA C22.2 No. 235 / IEC 60947-2 / GB 14048-2.

They perform distribution and subdistribution of the electric power supply and allow rapid assembly and disassembly of equipment.

Table 7.41: C60^{SP} Comb Busbars

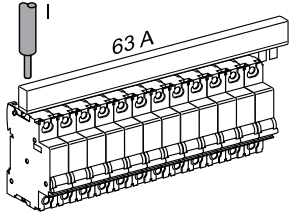
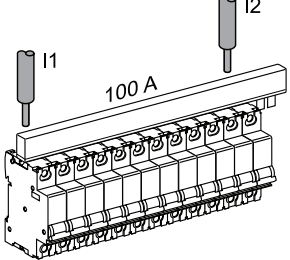
| Connection Accessories | Comb Busbars | | | Tooth Cover End-Piece |
|----------------------------------|--|---------------------|--|--|
| |  | | |  |
| Function | | | | |
| | <ul style="list-style-type: none"> • The comb busbars make it easier to install Schneider Electric circuit breakers UL1077 supplementary protection. • Power supply directly in the cage of the circuit breaker. | | | <ul style="list-style-type: none"> • The Tooth Caps are insulated protectors which may be slipped onto the unused teeth of the comb busbar. • They come in strips with 1-pole spacing, but can be snapped apart to be used individually. |
| Number of poles | 1P | 2P | 3P | All |
| Voltage rating (Ue) | 480Y/277 Vac | 480Y/277 Vac | 480Y/277 Vac | — |
| Catalogue numbers | 10285 | 10286 | 10287 | 60488 |
| Number of 18 mm modules | 12 (8.5 in./216 mm) | 12 (8.5 in./216 mm) | 12 (8.5 in./216 mm) | — |
| Set of | 1 | 1 | 1 | 20 |
| Technical Specifications | | | | |
| Insulation voltage (Ui) | 690 Vac | | | — |
| Impulse withstand voltage (Uimp) | 12 kV under 240 V 5 kV under 480Y/277 V or 277 V | | | — |
| Acceptable current at 40°C (Ie) | 63 A with 1 central power supply point | | 100 A with 2 power supply points | — |
| |  | |  | — |
| | Power supply via cable directly in the cage of the device: | | | — |
| | <ul style="list-style-type: none"> • cross section max: 3 AWG (25 mm²) • cross section min: 10 AWG (5.27 mm²) | | | — |

Multi9 C60 Accessories

Electrical Accessories for C60 Circuit Breakers and Supplementary Protectors

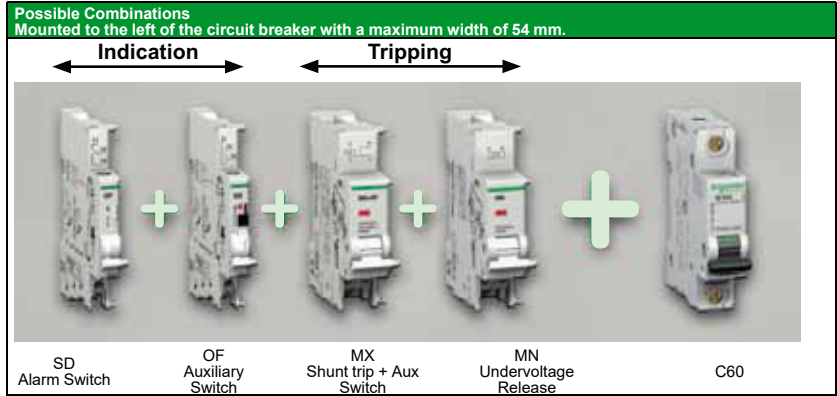
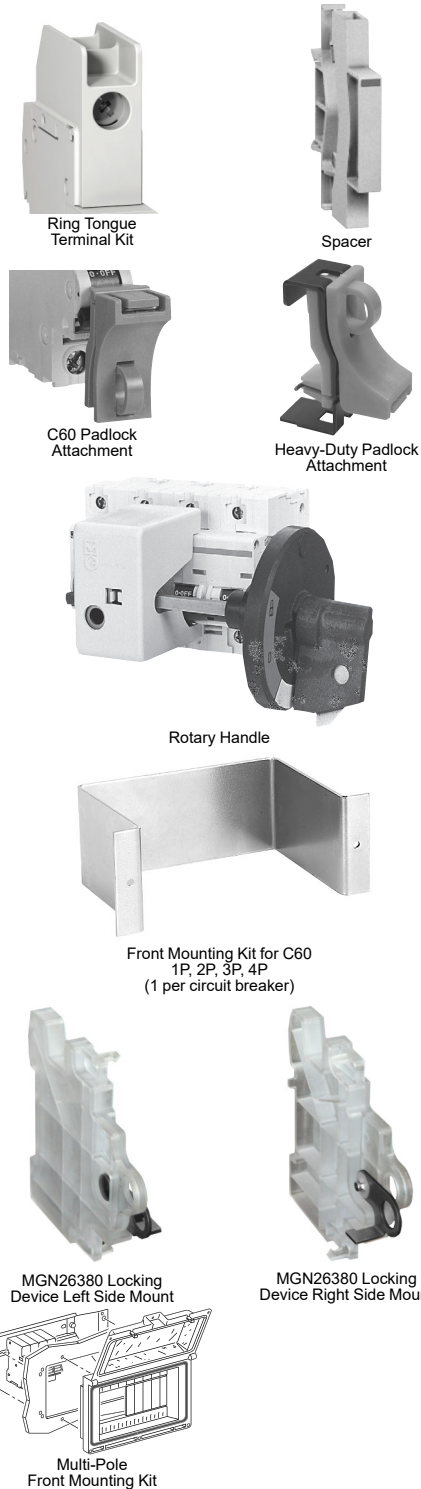

Table 7.42: Multi9 C60 Electrical Accessories

| Descriptions | Control Voltage | | Width in 9 mm Modules | C60 UL/IEC Cat. No. |
|---|---|--------|-----------------------|---------------------|
| | Vac | Vdc | | |
| OF Auxiliary Switch (1a1b) | 12–277 | 12–125 | 1 | M9A26924 |
| SD Alarm Switch (1a1b) | 12–277 | 12–125 | 1 | M9A26927 |
| MX Shunt Trip + OF Auxiliary Switch (1a1b) | 24 | 24 | 2 | M9A26948 |
| | 48 | 48 | 2 | M9A26947 |
| | 110–240–277 | 125 | 2 | M9A26946 |
| MN Undervoltage Release | 24 | 24 | 2 | M9A27108 |
| | 48 | 48 | 2 | M9A26961 |
| | 120 | — | 2 | M9A27107 |
| | 240 | — | 2 | M9A26960 |
| Multi9 GFP UL 1053 Listed Ground Fault Protectors | 120 to 480Y/277 Vac; 30, 100, and 300 mA; 2P and 4Ps. See Multi 9 GFP Ground Fault Protectors, page 7-26 or Catalog LVCA90EM_EN | | | |

Table 7.43: Multi9 C60 Mechanical Accessories

| Descriptions | C60 Cat. No. |
|--|--------------------------------|
| Ring tongue terminal kit for UL1077 C60 | For one pole M9A17400 |
| Spacer for DIN rail, Not UL Recognized | 9 mm wide 27062 |
| Padlock Attachment (1 per for 1P, 2P, 3P or 4P) | 2 per pack 26970 |
| Heavy-duty Padlock Attachment for C60, Locks OFF only | 2 per pack M9PAF |
| Padlocking Device Left Side Mount, Locks OFF only [1] | 1 per pack MGN26380 |
| Padlocking Device Right Side Mount, Locks OFF only [2] | |
| Front Mounting Kit | 1P MG26983 |
| | 2P MG26984 |
| | 3P MG26985 |
| | 4P MG26989 |
| Terminal Screw Shield (Not UL Recognized) | Bag of two 4P shields 26981 |
| Terminal cover (Not UL Recognized) | 1P 26975 |
| | 2P 26976 |
| | 3P 26975 + 26976 |
| | 4P 26978 |
| Rotary Handle for C60 (Non UL Recognized) | |
| Operating Subassembly | 2P/3P/4P 27046 |
| Door Interlock Handle | |
| Fixed Handle (Front or Lateral) | |
| Multi-pole Front Mounting Kit | |
| Rail Support (20 of 9 mm modules) | 14211 |
| Hinged Transparent Cover | 14210 |

[1] Left-side mounted padlocking device cannot be used in conjunction with accessories SD, OF, MX or MN. Use right-side mounted padlocking device when accessories are required.
[2] Right-side mounted padlocking device cannot be used in conjunction with VIGI module. Use left-side mounted padlocking device when VIGI Module is required.

The PowerPacT Advantage

- **Proven Performance:** Industry-leading circuit breaker innovation and protection for heavy-duty commercial and industrial applications.
- **Smart:** Integrated metering options provide a cost-effective solution to reduce energy consumption, optimize energy costs, and improve energy availability for your facilities.
- **Flexible:** Full range of thermal-magnetic and electronic trip molded case circuit breakers from 15 to 3000 A, delivering the ratings, configurations, and operators for your unique applications.
- **Simple:** Common catalog numbers, standardized ratings, and a full range of field-installable accessories make product selection, installation and maintenance easier than ever.
- **Common Design Features:** Mounting holes, door trim, and handle accessories

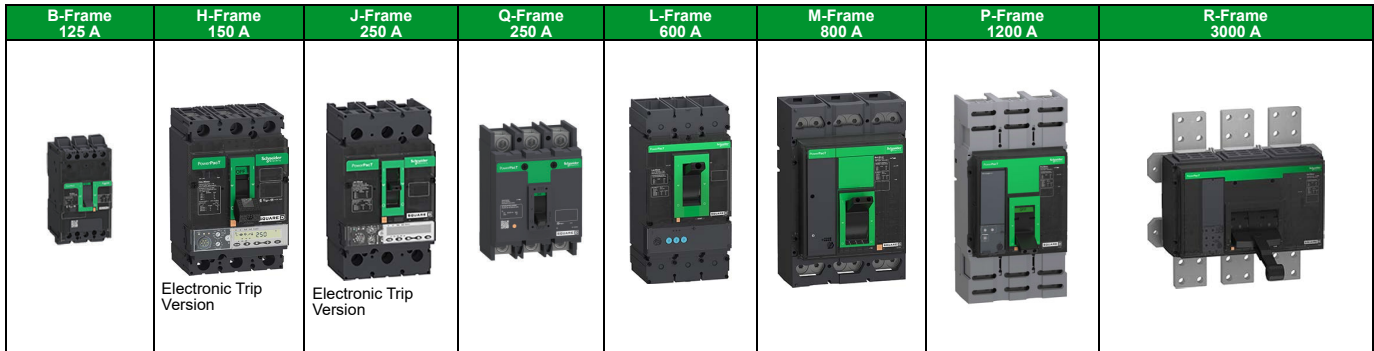

Table 7.44: PowerPacT Interrupting Ratings

| Voltage | Interrupting Rating | | | | | | |
|---------|---------------------|-------|-------|--------|-----------|-----------|--------|
| | B | D | G | J | K | L | R |
| 240 Vac | 10 kA | 25 kA | 65 kA | 100 kA | 65 kA [1] | 125 kA | 200 kA |
| 480 Vac | — | 18 kA | 35 kA | 65 kA | 65 kA [2] | 100 kA | 200 kA |
| 600 Vac | — | 14 kA | 18 kA | 25 kA | 65 kA [2] | 50 kA [3] | 100 kA |

[1] B-frame K interrupting rating is 100 kA at 240 Vac
 [2] P-frame K interrupting is 50 kA at 480 and 600 Vac.
 [3] P-frame L interrupting is 25 kA at 600 Vac.

Table 7.45: Common Catalog Numbering System

| Frame | Rating | Termination | Poles | Voltage | Amperage ^[4] | | | Suffix Code | | Suffix Code | |
|-------|--------|-------------|-------|---------|-------------------------|---|---|-------------|---|-------------|---|
| H | G | L | 3 | 6 | 1 | 5 | 0 | A | B | S | A |

1=1Pole
2=2Pole
3=3Pole
4=4Pole

4=480 V
6=600 V

2A/2B Auxiliary Switch

110 Vac Shunt Trip

Frame Designation

| | |
|---|--------------|
| B | 125 A Frame |
| H | 150 A Frame |
| J | 250 A Frame |
| Q | 250 A Frame |
| L | 600 A Frame |
| M | 800 A Frame |
| P | 1200 A Frame |
| R | 3000 A Frame |

Interrupting Rating

| | 240 Vac | 480 Vac | 600Vac |
|---|---------|---------|--------|
| B | 10 kA | — | — |
| D | 25 kA | 18 kA | 14 kA |
| G | 65 kA | 35 kA | 18 kA |
| J | 100 kA | 65 kA | 25 kA |
| K | 100 kA | 65 kA | 65 kA |
| L | 125 kA | 100 kA | 50 kA |
| R | 200 kA | 200 kA | 100 kA |

Terminations

| | |
|---|----------------------|
| A | I-Line |
| L | Lugs on Both Ends |
| F | Bus Bar (No Lugs) |
| M | Lugs Line Side Only |
| P | Lugs Load End Only |
| N | Plug-in |
| D | Drawout |
| S | Rear Connected Studs |

For more information:

- B-Frame Circuit Breakers, page 7-32
- H- and J-Frame Circuit Breakers, page 7-34
- Q-Frame Circuit Breakers, page 7-38
- L-Frame Circuit Breakers, page 7-40
- P-Frame Circuit Breakers, page 7-43
- R-Frame Circuit Breakers, page 7-44
- H, J, and L-Frame Motor Protectors, page 7-52
- Motor Circuit Protectors and Motor Protector Circuit Breakers, page 7-52
- Automatic Switches, page 7-48
- 500 Vdc Circuit Breakers, page 7-47
- Mission Critical Circuit Breakers, page 7-46
- Electrical Accessories for Circuit Breakers, page 7-55
- Motor Operators, page 7-56 and Rotary Handles, page 7-57
- Locks, Installation Accessories, and Rear Connectors, page 7-58
- Mechanical Lugs, page 7-60
- Compression Lugs, page 7-61 and Power Distribution Connectors, page 7-62
- Terminal Nuts, Terminal Pads, Terminal Shields, and Accessories, page 7-63
- Plug-In and Drawout Mountings, page 7-64
- MicroLogic Electronic Trip Units, page 7-65
- Trip Unit Accessories, page 7-68

[4] For amperage of M-, P- or R-frame circuit breakers, add a zero to the three amperage digits; for example, 120 = 1200 A.



B-Frame Thermal-Magnetic Trip Unit



With EverLink Lug Technology

PowerPacT B-Frame Molded Case Circuit Breakers (125 A)

PowerPacT B-frame circuit breakers provides economical thermal-magnetic circuit protection in a compact size.

- Fixed 15-125 A thermal-magnetic protection up to 600Y/347 Vac and 250 Vdc
- 1- to 4-pole unit mount construction; 1- to 3-pole I-Line construction
- UL listed interrupting ratings from 18 kA to 65 kA at 480 Vac
- EverLink lugs, a cable connection method that helps maintain low resistance connections
- UL, CSA, NOM, IEC, CCC certified and UKCA and CE marked for global acceptance

Table 7.46: PowerPacT B-Frame 125 A Thermal-Magnetic Circuit Breakers (600Y/347 Vac) with EverLink Lugs

| Current Rating @ 40° C | Interrupting Rating | | | | | | | | | | | | | |
|------------------------|------------------------|-----------------------------|-----------------------------|-----------------------------|------------------------|-----------------------------|-----------------------------|-----------------------------|------------------------|-----------------------------|-----------------------------|-----------------------------|----------------|---------------------|
| | D | | | | G | | | | J | | | | K | |
| | 1 Pole 347 Vac 125 Vdc | 2 Pole 600Y/347 Vac 250 Vdc | 3 Pole 600Y/347 Vac 250 Vdc | 4 Pole 600Y/347 Vac 250 Vdc | 1 Pole 347 Vac 125 Vdc | 2 Pole 600Y/347 Vac 250 Vdc | 3 Pole 600Y/347 Vac 250 Vdc | 4 Pole 600Y/347 Vac 250 Vdc | 1 Pole 347 Vac 125 Vdc | 2 Pole 600Y/347 Vac 250 Vdc | 3 Pole 600Y/347 Vac 250 Vdc | 4 Pole 600Y/347 Vac 250 Vdc | 1 Pole 347 Vac | 2 Pole 600Y/347 Vac |
| 15 A | BDL16015 | BDL26015 | BDL36015 | BDL46015 | BGL16015 | BGL26015 | BGL36015 | BGL46015 | BJL16015 | BJL26015 | BJL36015 | BJL46015 | BKL16015 | BKL26015 |
| 20 A | BDL16020 | BDL26020 | BDL36020 | BDL46020 | BGL16020 | BGL26020 | BGL36020 | BGL46020 | BJL16020 | BJL26020 | BJL36020 | BJL46020 | BKL16020 | BKL26020 |
| 25 A | BDL16025 | BDL26025 | BDL36025 | BDL46025 | BGL16025 | BGL26025 | BGL36025 | BGL46025 | BJL16025 | BJL26025 | BJL36025 | BJL46025 | BKL16025 | BKL26025 |
| 30 A | BDL16030 | BDL26030 | BDL36030 | BDL46030 | BGL16030 | BGL26030 | BGL36030 | BGL46030 | BJL16030 | BJL26030 | BJL36030 | BJL46030 | BKL16030 | BKL26030 |
| 35 A | BDL16035 | BDL26035 | BDL36035 | BDL46035 | BGL16035 | BGL26035 | BGL36035 | BGL46035 | BJL16035 | BJL26035 | BJL36035 | BJL46035 | — | — |
| 40 A | BDL16040 | BDL26040 | BDL36040 | BDL46040 | BGL16040 | BGL26040 | BGL36040 | BGL46040 | BJL16040 | BJL26040 | BJL36040 | BJL46040 | — | — |
| 45 A | BDL16045 | BDL26045 | BDL36045 | BDL46045 | BGL16045 | BGL26045 | BGL36045 | BGL46045 | BJL16045 | BJL26045 | BJL36045 | BJL46045 | — | — |
| 50 A | BDL16050 | BDL26050 | BDL36050 | BDL46050 | BGL16050 | BGL26050 | BGL36050 | BGL46050 | BJL16050 | BJL26050 | BJL36050 | BJL46050 | — | — |
| 60 A | BDL16060 | BDL26060 | BDL36060 | BDL46060 | BGL16060 | BGL26060 | BGL36060 | BGL46060 | BJL16060 | BJL26060 | BJL36060 | BJL46060 | — | — |
| 70 A | BDL16070 | BDL26070 | BDL36070 | BDL46070 | BGL16070 | BGL26070 | BGL36070 | BGL46070 | BJL16070 | BJL26070 | BJL36070 | BJL46070 | — | — |
| 80 A | BDL16080 | BDL26080 | BDL36080 | BDL46080 | BGL16080 | BGL26080 | BGL36080 | BGL46080 | BJL16080 | BJL26080 | BJL36080 | BJL46080 | — | — |
| 90 A | BDL16090 | BDL26090 | BDL36090 | BDL46090 | BGL16090 | BGL26090 | BGL36090 | BGL46090 | BJL16090 | BJL26090 | BJL36090 | BJL46090 | — | — |
| 100 A | BDL16100 | BDL26100 | BDL36100 | BDL46100 | BGL16100 | BGL26100 | BGL36100 | BGL46100 | BJL16100 | BJL26100 | BJL36100 | BJL46100 | — | — |
| 110 A | BDL16110 | BDL26110 | BDL36110 | BDL46110 | BGL16110 | BGL26110 | BGL36110 | BGL46110 | BJL16110 | BJL26110 | BJL36110 | BJL46110 | — | — |
| 125 A | BDL16125 | BDL26125 | BDL36125 | BDL46125 | BGL16125 | BGL26125 | BGL36125 | BGL46125 | BJL16125 | BJL26125 | BJL36125 | BJL46125 | — | — |

Table 7.47: B-Frame Interrupting Ratings

| Voltage | BD | | | | BG | | | | BJ | | | | BK | |
|------------------|---------------|---------------|---------------|---------------|---------------|---------------|---------------|---------------|---------------|---------------|---------------|---------------|---------------|---------------|
| | 1P 15 A-125 A | 2P 15 A-125 A | 3P 15 A-125 A | 4P 15 A-125 A | 1P 15 A-125 A | 2P 15 A-125 A | 3P 15 A-125 A | 4P 15 A-125 A | 1P 15 A-125 A | 2P 15 A-125 A | 3P 15 A-125 A | 4P 15 A-125 A | 1P 15 A- 30 A | 2P 15 A- 30 A |
| 240 Vac | 25 | 25 | 25 | 25 | 65 | 65 | 65 | 65 | 100 | 100 | 100 | 100 | 100 | 100 |
| 480Y/277 Vac [5] | | 18 | | | | 35 | | | | | | | | |
| 277 Vac | 18 | | | | 35 | | | | 65 | | | | 65 | |
| 480 Vac | | 18 | 18 | 18 | | 35 | 35 | 35 | | 65 | 65 | 65 | | 65 |
| 600Y/347 Vac | | 14 | 14 | 14 | | 18 | 18 | 18 | | 25 | 25 | 25 | | 65 |
| 347 Vac | 14 | | | | 18 | | | | 25 | | | | 65 | |
| 240 IØ - 3Ø | | 18 | | | | 35 | | | | 65 | | | | 65 |
| 125 Vdc | 10 | | | | 20 | | | | 50 | | | | | |
| 250 Vdc | | 10 | 10 | 10 | | 20 | 20 | 20 | | 50 | 50 | 50 | | |

[5] Only available with 480 V rated I-line catalogs.

Table 7.48: B-Frame Termination Options

| Termination Letter and Description | Example |
|--|---|
| A I-Line (See Section 9, Panelboards) | B D L 3 6 1 0 0 For factory-installed termination, place termination letter in the third block of the circuit breaker catalog number. In this example "L" indicates EverLink Lugs for both ON and OFF ends. |
| F No Lugs (includes terminal nut kit on both ends) | |
| L ON end: EverLink Lugs OFF end: EverLink Lugs | |
| M ON end: EverLink Lugs OFF end: Terminal Nut Kit | |
| P ON end: Terminal Nut Kit OFF end: EverLink Lugs | |

Table 7.49: B-Frame Lug Options

| Lug Option Suffix | |
|---|--|
| No Suffix = EverLink Lugs both ends | B D L 3 6 1 0 0 LU For factory-installed lug option, place suffix after the amperage in the circuit breaker catalog number. |
| LU = EverLink Lug with Control Wire Terminal ON end; EverLink Lug OFF end | |
| LV = EverLink Lug ON end; EverLink Lug with Control Wire Terminal OFF end | |
| LW = EverLink Lug with Control Wire Terminal both ends | |
| LC = Copper Mechanical Lugs both ends | |
| LH = Aluminum Mechanical Lugs both ends | |

Table 7.50: PowerPacT B-Frame 125 A Magnetic Trip Values

| Current Rating @ 40° C | Fixed AC Magnetic Trip | |
|------------------------|------------------------|--------|
| | Hold | Trip |
| 15 A | 400 A | 600 A |
| 20 A | 400 A | 600 A |
| 25 A | 480 A | 720 A |
| 30 A | 480 A | 720 A |
| 35 A | 480 A | 720 A |
| 40 A | 480 A | 720 A |
| 45 A | 480 A | 720 A |
| 50 A | 480 A | 720 A |
| 60 A | 640 A | 960 A |
| 70 A | 800 A | 1200 A |
| 80 A | 800 A | 1200 A |
| 90 A | 1000 A | 1500 A |
| 100 A | 1000 A | 1500 A |
| 110 A | 1000 A | 1500 A |
| 125 A | 1000 A | 1500 A |

Accessories see [page 7-55](#)
 Optional Lugs see [page 7-60](#)
 Dimensions see [page 7-86](#)



J-Frame
MicroLogic™ Trip Unit



J-Frame 3-Pole
Thermal-Magnetic Trip Unit

Table 7.51: Lug Kit Wire Ranges

| Sensor Rating | Standard Lug Kit | Terminal Wire Range |
|---------------|------------------|----------------------------|
| 60–150 A | AL150HD | 14–3/0 AWG Al or Cu |
| 250 A | AL250JD | 3/0 AWG–350 kcmil Al or Cu |

PowerPacT H- and J-Frame Molded-Case Circuit Breakers (150 A and 250 A)

A flexible, high performance offer certified to global standards.

- Thermal magnetic or MicroLogic™ trip protection from 15–250 A up to 600 Vac and 250 Vdc
- 2 and 3-pole unit mount and I-Line constructions^[6]
- High performance UL listed interrupting ratings from 18 to 200 kA at 480 Vac
- H- and J-Frame have common mounting holes, handle locations and trim dimensions with many shared accessories and auxiliaries.
- UL, CSA, NOM, IEC, CCC certified, and UKCA and CE marked for global acceptance.

Table 7.52: H- and J-Frame Interrupting Ratings

| Voltage | Interrupting Rating | | | | |
|------------------------|---------------------|-------|--------|--------|--------|
| | D | G | J | L | R |
| 240 Vac | 25 kA | 65 kA | 100 kA | 125 kA | 200 kA |
| 480 Vac | 18 kA | 35 kA | 65 kA | 100 kA | 200 kA |
| 600 Vac | 14 kA | 18 kA | 25 kA | 50 kA | 100 kA |
| 250 Vdc ^[7] | 20 kA | 20 kA | 20 kA | 20 kA | — |

Table 7.53: H- and J-Frame Termination Options

| Termination Letter | |
|--|--|
| A - I-Line (See Section 9—Panelboards) | H D L 3 6 0 1 5 For factory-installed termination, place termination letter in the third block of the circuit breaker catalog number. |
| F = No Lugs (includes terminal nut kit on both ends) | |
| L = Lugs both ends | |
| M = Lugs ON end Terminal Nut Kit OFF end | |
| P = Lugs OFF end Terminal Nut Kit ON end | |
| N = Plug-in | |
| D = Drawout | |
| S = Rear Connected | |

Accessories see [page 7-55](#)

Optional Lugs see [page 7-60](#)

Dimensions see [page 7-86](#)

Enclosures see [page 7-87](#)

[6] H- and J- frame circuit breakers can be used as a main or sub-feed circuit breaker in an NQ or NF panelboard.

[7] Not available with electronic trip units.

PowerPacT H-Frame Thermal-Magnetic Circuit Breakers

Table 7.54: PowerPacT H-Frame 150 A Thermal-Magnetic UL Current-Limiting [8] Circuit Breakers (600 Vac, 250 Vdc) [9] With Factory Sealed Trip Unit Suitable for Reverse Connection [10]

| Current Rating @ 40°C | Fixed AC Magnetic Trip | | Interrupting Rating | | | | | | | |
|--|------------------------|--------|----------------------|------------|----------------------|------------|----------------------|------------|----------------------|------------|
| | | | D | | G | | J [9] | | L [9] | |
| | Hold | Trip | Standard (80% Rated) | 100% Rated | Standard (80% Rated) | 100% Rated | Standard (80% Rated) | 100% Rated | Standard (80% Rated) | 100% Rated |
| H-Frame, 150A 2P, 600 Vac 50/60 Hz, 250 Vdc [11] | | | | | | | | | | |
| 15 A | 350 A | 750 A | HDL26015 | HDL26015C | HGL26015 | HGL26015C | HJL26015 | HJL26015C | HLL26015 | HLL26015C |
| 20 A | 350 A | 750 A | HDL26020 | HDL26020C | HGL26020 | HGL26020C | HJL26020 | HJL26020C | HLL26020 | HLL26020C |
| 25 A | 350 A | 750 A | HDL26025 | HDL26025C | HGL26025 | HGL26025C | HJL26025 | HJL26025C | HLL26025 | HLL26025C |
| 30 A | 350 A | 750 A | HDL26030 | HDL26030C | HGL26030 | HGL26030C | HJL26030 | HJL26030C | HLL26030 | HLL26030C |
| 35 A | 400 A | 850 A | HDL26035 | HDL26035C | HGL26035 | HGL26035C | HJL26035 | HJL26035C | HLL26035 | HLL26035C |
| 40 A | 400 A | 850 A | HDL26040 | HDL26040C | HGL26040 | HGL26040C | HJL26040 | HJL26040C | HLL26040 | HLL26040C |
| 45 A | 400 A | 850 A | HDL26045 | HDL26045C | HGL26045 | HGL26045C | HJL26045 | HJL26045C | HLL26045 | HLL26045C |
| 50 A | 400 A | 850 A | HDL26050 | HDL26050C | HGL26050 | HGL26050C | HJL26050 | HJL26050C | HLL26050 | HLL26050C |
| 60 A | 800 A | 1450 A | HDL26060 | HDL26060C | HGL26060 | HGL26060C | HJL26060 | HJL26060C | HLL26060 | HLL26060C |
| 70 A | 800 A | 1450 A | HDL26070 | HDL26070C | HGL26070 | HGL26070C | HJL26070 | HJL26070C | HLL26070 | HLL26070C |
| 80 A | 800 A | 1450 A | HDL26080 | HDL26080C | HGL26080 | HGL26080C | HJL26080 | HJL26080C | HLL26080 | HLL26080C |
| 90 A | 800 A | 1450 A | HDL26090 | HDL26090C | HGL26090 | HGL26090C | HJL26090 | HJL26090C | HLL26090 | HLL26090C |
| 100 A | 800 A | 1700 A | HDL26100 | HDL26100C | HGL26100 | HGL26100C | HJL26100 | HJL26100C | HLL26100 | HLL26100C |
| 110 A | 900 A | 1700 A | HDL26110 | HDL26110C | HGL26110 | HGL26110C | HJL26110 | HJL26110C | HLL26110 | HLL26110C |
| 125 A | 900 A | 1700 A | HDL26125 | HDL26125C | HGL26125 | HGL26125C | HJL26125 | HJL26125C | HLL26125 | HLL26125C |
| 150 A | 900 A | 1700 A | HDL26150 | HDL26150C | HGL26150 | HGL26150C | HJL26150 | HJL26150C | HLL26150 | HLL26150C |
| H-Frame 150A 3P, 600 Vac 50/60 Hz, 250 Vdc | | | | | | | | | | |
| 15 A | 350 A | 750 A | HDL36015 | HDL36015C | HGL36015 | HGL36015C | HJL36015 | HJL36015C | HLL36015 | HLL36015C |
| 20 A | 350 A | 750 A | HDL36020 | HDL36020C | HGL36020 | HGL36020C | HJL36020 | HJL36020C | HLL36020 | HLL36020C |
| 25 A | 350 A | 750 A | HDL36025 | HDL36025C | HGL36025 | HGL36025C | HJL36025 | HJL36025C | HLL36025 | HLL36025C |
| 30 A | 350 A | 750 A | HDL36030 | HDL36030C | HGL36030 | HGL36030C | HJL36030 | HJL36030C | HLL36030 | HLL36030C |
| 35 A | 400 A | 850 A | HDL36035 | HDL36035C | HGL36035 | HGL36035C | HJL36035 | HJL36035C | HLL36035 | HLL36035C |
| 40 A | 400 A | 850 A | HDL36040 | HDL36040C | HGL36040 | HGL36040C | HJL36040 | HJL36040C | HLL36040 | HLL36040C |
| 45 A | 400 A | 850 A | HDL36045 | HDL36045C | HGL36045 | HGL36045C | HJL36045 | HJL36045C | HLL36045 | HLL36045C |
| 50 A | 400 A | 850 A | HDL36050 | HDL36050C | HGL36050 | HGL36050C | HJL36050 | HJL36050C | HLL36050 | HLL36050C |
| 60 A | 800 A | 1450 A | HDL36060 | HDL36060C | HGL36060 | HGL36060C | HJL36060 | HJL36060C | HLL36060 | HLL36060C |
| 70 A | 800 A | 1450 A | HDL36070 | HDL36070C | HGL36070 | HGL36070C | HJL36070 | HJL36070C | HLL36070 | HLL36070C |
| 80 A | 800 A | 1450 A | HDL36080 | HDL36080C | HGL36080 | HGL36080C | HJL36080 | HJL36080C | HLL36080 | HLL36080C |
| 90 A | 800 A | 1450 A | HDL36090 | HDL36090C | HGL36090 | HGL36090C | HJL36090 | HJL36090C | HLL36090 | HLL36090C |
| 100 A | 800 A | 1700 A | HDL36100 | HDL36100C | HGL36100 | HGL36100C | HJL36100 | HJL36100C | HLL36100 | HLL36100C |
| 110 A | 900 A | 1700 A | HDL36110 | HDL36110C | HGL36110 | HGL36110C | HJL36110 | HJL36110C | HLL36110 | HLL36110C |
| 125 A | 900 A | 1700 A | HDL36125 | HDL36125C | HGL36125 | HGL36125C | HJL36125 | HJL36125C | HLL36125 | HLL36125C |
| 150 A | 900 A | 1700 A | HDL36150 | HDL36150C | HGL36150 | HGL36150C | HJL36150 | HJL36150C | HLL36150 | HLL36150C |

HJ and HL are UL certified as current limiting circuit breakers.

PowerPacT J-Frame Thermal-Magnetic Circuit Breakers

Table 7.55: J-Frame 250 A Thermal-Magnetic UL Current-Limiting [12] Circuit Breakers (600 Vac, 250 Vdc) With Factory Sealed Trip Unit Suitable for Reverse Connection [10]

| Current Rating @ 40°C | Adjustable AC Magnetic Trip | | Interrupting Rating | | | | | | | | | |
|--|-----------------------------|--------|----------------------|------------|----------------------|------------|----------------------|------------|----------------------|------------|----------------------|------------|
| | | | D | | G | | J [12] | | L [12] | | R [12] | |
| | Low | High | Standard (80% Rated) | 100% Rated | Standard (80% Rated) | 100% Rated | Standard (80% Rated) | 100% Rated | Standard (80% Rated) | 100% Rated | Standard (80% Rated) | 100% Rated |
| J-Frame 250 A 2P, 600 Vac 50/60 Hz, 250 Vdc [13] | | | | | | | | | | | | |
| 150 A | 750 A | 1500 A | JDL26150 | JDL26150C | JGL26150 | JGL26150C | JJL26150 | JJL26150C | JLL26150 | JLL26150C | — | — |
| 175 A | 875 A | 1750 A | JDL26175 | JDL26175C | JGL26175 | JGL26175C | JJL26175 | JJL26175C | JLL26175 | JLL26175C | — | — |
| 200 A | 1000 A | 2000 A | JDL26200 | JDL26200C | JGL26200 | JGL26200C | JJL26200 | JJL26200C | JLL26200 | JLL26200C | — | — |
| 225 A | 1125 A | 2250 A | JDL26225 | JDL26225C | JGL26225 | JGL26225C | JJL26225 | JJL26225C | JLL26225 | JLL26225C | — | — |
| 250 A | 1250 A | 2500 A | JDL26250 | JDL26250C | JGL26250 | JGL26250C | JJL26250 | JJL26250C | JLL26250 | JLL26250C | — | — |
| J-Frame 250 A 3P, 600 Vac 50/60 Hz, 250 Vdc | | | | | | | | | | | | |
| 150 A | 750 A | 1500 A | JDL36150 | JDL36150C | JGL36150 | JGL36150C | JJL36150 | JJL36150C | JLL36150 | JLL36150C | JRL36150 | JRL36150C |
| 175 A | 875 A | 1750 A | JDL36175 | JDL36175C | JGL36175 | JGL36175C | JJL36175 | JJL36175C | JLL36175 | JLL36175C | JRL36175 | JRL36175C |
| 200 A | 1000 A | 2000 A | JDL36200 | JDL36200C | JGL36200 | JGL36200C | JJL36200 | JJL36200C | JLL36200 | JLL36200C | JRL36200 | JRL36200C |
| 225 A | 1125 A | 2250 A | JDL36225 | JDL36225C | JGL36225 | JGL36225C | JJL36225 | JJL36225C | JLL36225 | JLL36225C | JRL36225 | JRL36225C |
| 250 A | 1250 A | 2500 A | JDL36250 | JDL36250C | JGL36250 | JGL36250C | JJL36250 | JJL36250C | JLL36250 | JLL36250C | JRL36250 | JRL36250C |

JJ, JL and JR are UL certified as current limiting circuit breakers.

[8] Circuit breakers with J and L interrupting ratings are UL certified as current limiting.
 [9] Standard lug kit: AL150HD. Terminal wire range: 14–3/0 AWG Al or Cu.
 [10] See Supplemental Digest Section 3 for circuit breakers with field interchangeable trip units.
 [11] HD and HG circuit breakers are true two-pole construction.
 [12] Circuit breakers with J, L, and R interrupting ratings are UL certified as current limiting.
 [13] 2P in a 3P module

PowerPacT H- and J-Frame Electronic Trip Current Limiting Circuit Breakers (150 A and 250 A)



H-Frame MicroLogic™ Trip Unit



J-Frame MicroLogic™ Trip Unit

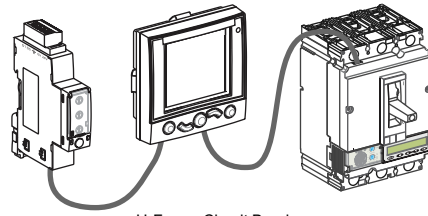

H-Frame Circuit Breaker
Optional FDM and IFM Module

Table 7.56: H-Frame 150 A and J-Frame 250 A Electronic Trip UL Current-Limiting [14] Standard (80% Rated) Circuit Breakers (600 Vac) With Factory Sealed Trip Unit [15] Suitable for Reverse Connection [16]

| Electronic Trip Unit | | | Sensor Rating | Interrupting Rating (80% Rated) | | | | |
|-----------------------|----------|-------------------|---------------|---------------------------------|--------------|--------------|--------------|--------------|
| Type | Function | Trip Unit | | D | G | J [14] | L [14] | R [14] |
| 600 Vac, 50/60 Hz, 3P | | | | | | | | |
| MicroLogic Standard | LI | 3.2 [17] | 60 A | HDL36060U31X | HGL36060U31X | HJL36060U31X | HLL36060U31X | HRL36060U31X |
| | | | 100 A | HDL36100U31X | HGL36100U31X | HJL36100U31X | HLL36100U31X | HRL36100U31X |
| | | | 150 A | HDL36150U31X | HGL36150U31X | HJL36150U31X | HLL36150U31X | HRL36150U31X |
| | | | 250 A | JDL36250U31X | JGL36250U31X | JJL36250U31X | JLL36250U31X | JRL36250U31X |
| MicroLogic Standard | LSI | 3.2S [17] [18] | 60 A | HDL36060U33X | HGL36060U33X | HJL36060U33X | HLL36060U33X | HRL36060U33X |
| | | | 100 A | HDL36100U33X | HGL36100U33X | HJL36100U33X | HLL36100U33X | HRL36100U33X |
| | | | 150 A | HDL36150U33X | HGL36150U33X | HJL36150U33X | HLL36150U33X | HRL36150U33X |
| | | | 250 A | JDL36250U33X | JGL36250U33X | JJL36250U33X | JLL36250U33X | JRL36250U33X |
| MicroLogic Ammeter | LSI | 5.2A | 60 A | HDL36060U43X | HGL36060U43X | HJL36060U43X | HLL36060U43X | HRL36060U43X |
| | | | 100 A | HDL36100U43X | HGL36100U43X | HJL36100U43X | HLL36100U43X | HRL36100U43X |
| | | | 150 A | HDL36150U43X | HGL36150U43X | HJL36150U43X | HLL36150U43X | HRL36150U43X |
| | | | 250 A | JDL36250U43X | JGL36250U43X | JJL36250U43X | JLL36250U43X | JRL36250U43X |
| MicroLogic Energy | LSI | 5.2E | 60 A | HDL36060U53X | HGL36060U53X | HJL36060U53X | HLL36060U53X | HRL36060U53X |
| | | | 100 A | HDL36100U53X | HGL36100U53X | HJL36100U53X | HLL36100U53X | HRL36100U53X |
| | | | 150 A | HDL36150U53X | HGL36150U53X | HJL36150U53X | HLL36150U53X | HRL36150U53X |
| | | | 250 A | JDL36250U53X | JGL36250U53X | JJL36250U53X | JLL36250U53X | JRL36250U53X |
| MicroLogic Ammeter | LSIG | 6.2A [19] | 60 A | HDL36060U44X | HGL36060U44X | HJL36060U44X | HLL36060U44X | HRL36060U44X |
| | | | 100 A | HDL36100U44X | HGL36100U44X | HJL36100U44X | HLL36100U44X | HRL36100U44X |
| | | | 150 A | HDL36150U44X | HGL36150U44X | HJL36150U44X | HLL36150U44X | HRL36150U44X |
| | | | 250 A | JDL36250U44X | JGL36250U44X | JJL36250U44X | JLL36250U44X | JRL36250U44X |
| MicroLogic Energy | LSIG | 6.2E | 60 A | HDL36060U54X | HGL36060U54X | HJL36060U54X | HLL36060U54X | HRL36060U54X |
| | | | 100 A | HDL36100U54X | HGL36100U54X | HJL36100U54X | HLL36100U54X | HRL36100U54X |
| | | | 150 A | HDL36150U54X | HGL36150U54X | HJL36150U54X | HLL36150U54X | HRL36150U54X |
| | | | 250 A | JDL36250U54X | JGL36250U54X | JJL36250U54X | JLL36250U54X | JRL36250U54X |

[14] Circuit breakers with J, L, and R interrupting ratings are UL certified as current limiting.

[15] See Supplemental Digest Section 3 for circuit breakers with field interchangeable trip units.

[16] For applications requiring communications see page 7-68.

[17] 3P circuit breakers with this trip unit can be used for 2P applications.

[18] Fixed ST and LT delays.

[19] 3P circuit breakers with this trip unit can be used for 2P applications requiring ground fault protection. Additional metering capabilities will not work properly on the unconnected phase.

Table 7.57: H-Frame 150 A and J-Frame 250 A Electronic Trip UL Current-Limiting [20] 100% Rated Circuit Breakers (600 Vac) With Factory Sealed Trip Unit [21] Suitable for Reverse Connection [22]

| Electronic Trip Unit | | | Sensor Rating | Interrupting Rating (100% Rated) | | | | |
|---------------------------|----------|-------------------|---------------|----------------------------------|---------------|---------------|---------------|---------------|
| Type | Function | Trip Unit | | D | G | J [20] | L [20] | R [20] |
| 600 Vac, 50/60 Hz, 3P[23] | | | | | | | | |
| MicroLogic Standard | LI | 3.2 [24] | 60 A | HDL36060CU31X | HGL36060CU31X | HJL36060CU31X | HLL36060CU31X | HRL36060CU31X |
| | | | 100 A | HDL36100CU31X | HGL36100CU31X | HJL36100CU31X | HLL36100CU31X | HRL36100CU31X |
| | | | 150 A | HDL36150CU31X | HGL36150CU31X | HJL36150CU31X | HLL36150CU31X | HRL36150CU31X |
| | | | 250 A | JDL36250CU31X | JGL36250CU31X | JJL36250CU31X | JLL36250CU31X | JRL36250CU31X |
| MicroLogic Standard | LSI | 3.2S [24] [25] | 60 A | HDL36060CU33X | HGL36060CU33X | HJL36060CU33X | HLL36060CU33X | HRL36060CU33X |
| | | | 100 A | HDL36100CU33X | HGL36100CU33X | HJL36100CU33X | HLL36100CU33X | HRL36100CU33X |
| | | | 150 A | HDL36150CU33X | HGL36150CU33X | HJL36150CU33X | HLL36150CU33X | HRL36150CU33X |
| | | | 250 A | JDL36250CU33X | JGL36250CU33X | JJL36250CU33X | JLL36250CU33X | JRL36250CU33X |
| MicroLogic Ammeter | LSI | 5.2A | 60 A | HDL36060CU43X | HGL36060CU43X | HJL36060CU43X | HLL36060CU43X | HRL36060CU43X |
| | | | 100 A | HDL36100CU43X | HGL36100CU43X | HJL36100CU43X | HLL36100CU43X | HRL36100CU43X |
| | | | 150 A | HDL36150CU43X | HGL36150CU43X | HJL36150CU43X | HLL36150CU43X | HRL36150CU43X |
| | | | 250 A | JDL36250CU43X | JGL36250CU43X | JJL36250CU43X | JLL36250CU43X | JRL36250CU43X |
| MicroLogic Energy | LSI | 5.2E | 60 A | HDL36060CU53X | HGL36060CU53X | HJL36060CU53X | HLL36060CU53X | HRL36060CU53X |
| | | | 100 A | HDL36100CU53X | HGL36100CU53X | HJL36100CU53X | HLL36100CU53X | HRL36100CU53X |
| | | | 150 A | HDL36150CU53X | HGL36150CU53X | HJL36150CU53X | HLL36150CU53X | HRL36150CU53X |
| | | | 250 A | JDL36250CU53X | JGL36250CU53X | JJL36250CU53X | JLL36250CU53X | JRL36250CU53X |
| MicroLogic Ammeter | LSIG | 6.2A [26] | 60 A | HDL36060CU44X | HGL36060CU44X | HJL36060CU44X | HLL36060CU44X | HRL36060CU44X |
| | | | 100 A | HDL36100CU44X | HGL36100CU44X | HJL36100CU44X | HLL36100CU44X | HRL36100CU44X |
| | | | 150 A | HDL36150CU44X | HGL36150CU44X | HJL36150CU44X | HLL36150CU44X | HRL36150CU44X |
| | | | 250 A | JDL36250CU44X | JGL36250CU44X | JJL36250CU44X | JLL36250CU44X | JRL36250CU44X |
| MicroLogic Energy | LSIG | 6.2E | 60 A | HDL36060CU54X | HGL36060CU54X | HJL36060CU54X | HLL36060CU54X | HRL36060CU54X |
| | | | 100 A | HDL36100CU54X | HGL36100CU54X | HJL36100CU54X | HLL36100CU54X | HRL36100CU54X |
| | | | 150 A | HDL36150CU54X | HGL36150CU54X | HJL36150CU54X | HLL36150CU54X | HRL36150CU54X |
| | | | 250 A | JDL36250CU54X | JGL36250CU54X | JJL36250CU54X | JLL36250CU54X | JRL36250CU54X |

Accessories see page 7-55
 Optional Lugs see page 7-60
 Dimensions see page 7-86
 Enclosures see page 7-87

[20] Circuit breakers with J, L, and R interrupting ratings are UL certified as current limiting.
 [21] See Supplemental Digest Section 3 for circuit breakers with field interchangeable trip units.
 [22] For applications requiring communications see page 7-68.
 [23] 3-pole PowerPacT H- and J-frame circuit breakers can be used for 2-pole applications. (For such instances, MicroLogic 6.2 Ammeter and Energy trip units can be used for ground fault protection. Additional metering capabilities are not guaranteed when using MicroLogic Ammeter and Energy trip units for this type of application.
 [24] 3P circuit breakers with this trip unit can be used for 2P applications.
 [25] Fixed ST and LT delays.
 [26] 3P circuit breakers with this trip unit can be used for 2P applications requiring ground fault protection. Additional metering capabilities will not work properly on the unconnected phase.

Class 0734 / Refer to Catalog: 0734CT0201

Q-Frame Molded Case Circuit Breakers (250 A)

PowerPacT Q-frame circuit breakers are used for overcurrent protection and switching on 240 Vac applications.^[27]

- Fixed thermal magnetic protection from 70–250 A at 240 Vac
- 2- and 3-pole unit mount and I-Line constructions^[28]
- UL listed interruption ratings from 10 kA to 100 kA at 240 Vac
- Available in standard (80%) rating only
- cULus and NOM certified



2-Pole Q-Frame with Thermal-Magnetic Trip Unit 70–250



3-Pole Q-Frame with Thermal-Magnetic Trip Unit 70–250 A

Table 7.58: PowerPacT Q-Frame 250 A Thermal-Magnetic Circuit Breaker (240 Vac)

| Ampere Rating | Fixed AC Magnetic Trip | | Interrupting Rating | | | | Terminal Wire Range |
|-----------------------|------------------------|--------|---------------------|----------|----------|----------|--------------------------|
| | Hold | Trip | B | D | G | J | |
| 2P, 240 Vac | | | | | | | |
| 70 A | 1000 A | 1800 A | QBL22070 | QDL22070 | QGL22070 | QJL22070 | #4 AWG - 300 kcmil Al/Cu |
| 80 A | 1000 A | 1800 A | QBL22080 | QDL22080 | QGL22080 | QJL22080 | |
| 90 A | 1000 A | 1800 A | QBL22090 | QDL22090 | QGL22090 | QJL22090 | |
| 100 A | 1200 A | 2400 A | QBL22100 | QDL22100 | QGL22100 | QJL22100 | |
| 110 A | 1200 A | 2400 A | QBL22110 | QDL22110 | QGL22110 | QJL22110 | |
| 125 A | 1200 A | 2400 A | QBL22125 | QDL22125 | QGL22125 | QJL22125 | |
| 150 A | 1200 A | 2400 A | QBL22150 | QDL22150 | QGL22150 | QJL22150 | |
| 175 A | 1200 A | 2400 A | QBL22175 | QDL22175 | QGL22175 | QJL22175 | |
| 200 A | 1200 A | 2400 A | QBL22200 | QDL22200 | QGL22200 | QJL22200 | |
| 225 A | 1200 A | 2400 A | QBL22225 | QDL22225 | QGL22225 | QJL22225 | |
| 250 A ^[29] | 1200 A | 2400 A | QBL22250 | QDL22250 | QGL22250 | QJL22250 | |
| 3P, 240 Vac | | | | | | | |
| 70 A | 1000 A | 1800 A | QBL32070 | QDL32070 | QGL32070 | QJL32070 | #4 AWG - 300 kcmil Al/Cu |
| 80 A | 1000 A | 1800 A | QBL32080 | QDL32080 | QGL32080 | QJL32080 | |
| 90 A | 1000 A | 1800 A | QBL32090 | QDL32090 | QGL32090 | QJL32090 | |
| 100 A | 1200 A | 2400 A | QBL32100 | QDL32100 | QGL32100 | QJL32100 | |
| 110 A | 1200 A | 2400 A | QBL32110 | QDL32110 | QGL32110 | QJL32110 | |
| 125 A | 1200 A | 2400 A | QBL32125 | QDL32125 | QGL32125 | QJL32125 | |
| 150 A | 1200 A | 2400 A | QBL32150 | QDL32150 | QGL32150 | QJL32150 | |
| 175 A | 1200 A | 2400 A | QBL32175 | QDL32175 | QGL32175 | QJL32175 | |
| 200 A | 1200 A | 2400 A | QBL32200 | QDL32200 | QGL32200 | QJL32200 | |
| 225 A | 1200 A | 2400 A | QBL32225 | QDL32225 | QGL32225 | QJL32225 | |
| 250 A ^[30] | 1200 A | 2400 A | QBL32250 | QDL32250 | QGL32250 | QJL32250 | |

Table 7.59: Q-Frame Interrupting Ratings

| Voltage | Interrupting Rating | | | |
|---------|---------------------|-------|-------|------------------------|
| | B | D | G | J |
| 240 Vac | 10 kA | 25 kA | 65 kA | 100 kA ^[31] |

Table 7.60: Q-Frame Termination Options

| Termination Letter | Q G L 3 2 2 0 0 |
|--|---|
| A = I-Line (See Section 9—Panelboards) | For factory-installed termination, place termination letter in the third block of the circuit breaker catalog number. |
| E = Bolt-on I-Line (See Section 9) | |
| F = No lugs | |
| L = Lugs both ends | |
| M = Lugs ON end, studs on OFF end | |
| P = Lugs OFF end, studs on ON end | |

Dimension see page 7-86

Enclosures see page 7-87

^[27] Replacement lugs and electrical accessories are not available for PowerPacT Q-frame circuit breakers.

^[28] Q-frame can be used as main or sub-feed circuit breaker in a NQ panelboard.

^[29] 250 A lugs are suitable for copper conductors only.

^[30] 250 A circuit breakers are suitable for copper conductors only.

^[31] 3P QJ circuit breakers are rated at 208Y/120 Vac only.



LA/LHL
2P and 3P 125–400 A

LA/LH-Frame Molded Case Circuit Breaker (600 A)

- Thermal magnetic protection from 125-400 A up to 600 Vac and 250 Vdc
- 2- and 3-pole unit mount and I-Line constructions
- UL listed interrupting ratings from 30 kA to 35 kA at 480 Vac
- UL and CSA certified

NOTE: Consider using PowerPacT™ circuit breakers for situations requiring circuit breaker accessories. See [PowerPacT Accessories](#), page 7-55 for more information.

Table 7.61: LA/LH-Frame, 600 A, Thermal-Magnetic, Individually-Mounted Circuit Breakers, 600 Vac

| Ampere Rating | Adjustable AC Magnetic Trip | | Cat. No. | | Terminal Wire Range |
|-----------------------------|-----------------------------|--------|-----------------------|-------------------|--|
| | Low | High | Standard Interrupting | High Interrupting | |
| 2P, 600 Vac, 250 Vdc | | | | | |
| 125 A | 625 A | 1250 A | LAL26125 | LHL26125 | AL400LA (1) 1 AWG–600 kcmil Al or (2) 1 AWG–250 kcmil Al |
| 150 A | 750 A | 1500 A | LAL26150 | LHL26150 | |
| 175 A | 875 A | 1750 A | LAL26175 | LHL26175 | |
| 200 A | 1000 A | 2000 A | LAL26200 | LHL26200 | |
| 225 A | 1125 A | 2250 A | LAL26225 | LHL26225 | |
| 250 A | 1250 A | 2500 A | LAL26250 | LHL26250 | |
| 300 A | 1500 A | 3000 A | LAL26300 | LHL26300 | |
| 350 A | 1750 A | 3500 A | LAL26350 | LHL26350 | |
| 400 A | 2000 A | 4000 A | LAL26400 | LHL26400 | |
| 3P, 600 Vac, 250 Vdc | | | | | |
| 125 A | 625 A | 1250 A | LAL36125 | LHL36125 | AL400LA (1) 1 AWG–600 kcmil Al or (2) 1 AWG–250 kcmil Al |
| 150 A | 750 A | 1500 A | LAL36150 | LHL36150 | |
| 175 A | 875 A | 1750 A | LAL36175 | LHL36175 | |
| 200 A | 1000 A | 2000 A | LAL36200 | LHL36200 | |
| 225 A | 1125 A | 2250 A | LAL36225 | LHL36225 | |
| 250 A | 1250 A | 2500 A | LAL36250 | LHL36250 | |
| 300 A | 1500 A | 3000 A | LAL36300 | LHL36300 | |
| 350 A | 1750 A | 3500 A | LAL36350 | LHL36350 | |
| 400 A | 2000 A | 4000 A | LAL36400 | LHL36400 | |

Table 7.62: Interrupting Ratings

| Voltage | LAL | LHL |
|---------|-------|-------|
| 240 Vac | 42 kA | 65 kA |
| 480 Vac | 30 kA | 35 kA |
| 600 Vac | 22 kA | 25 kA |

Accessories see [PowerPacT Accessories](#), page 7-55 through [Plug-In and Drawout Mountings](#), page 7-64

Optional Lugs see [Mechanical Lug Information](#), page Supplemental Digest Section 3.

Dimensions see [Dimensions and Shipping Weights](#), page 7-85

Enclosures see [Circuit Breaker Enclosures](#), page 7-87

PowerPacT L-Frame Molded Case Circuit Breakers (600 A)

A flexible, high performance offer certified to global standards.

- Basic Electronic and MicroLogic trip protection from 250–600 Vac
- 2-, 3- and 4-pole design; wide range of trip units to protect most applications
- High performance UL listed interrupting ratings from 35 kA to 200 kA at 480 Vac
- Standard (80%) or 100% rating
- UL, CSA, NOM, IEC, CCC certified, and UKCA and CE marked for global acceptance



PowerPacT L-Frame with MicroLogic™ Trip Unit

Table 7.63: L-Frame 600 A Standard (80% Rated) UL Current-Limiting [32] Circuit Breakers (600 Vac) with Lugs and Factory-Sealed Electronic Trip Units Suitable for Reverse Connection [33][34]

| Electronic Trip Unit | | | Sensor Rating | Interrupting Rating (80% Rated) | | | | |
|-----------------------|----------|-------------------|---------------|---------------------------------|--------------|--------------|--------------|-----------------|
| Type | Function | Trip Unit | | G | J [32] | L [32] | R [32] | Terminal |
| 600 Vac, 50/60 Hz, 3P | | | | | | | | |
| MicroLogic Standard | LI | 3.3 [35] | 250 A | LGL36250U31X | LJL36250U31X | LLL36250U31X | LRL36250U31X | AL400L61K3 [36] |
| | | | 400 A | LGL36400U31X | LJL36400U31X | LLL36400U31X | LRL36400U31X | AL600LS52K3 |
| | | | 600 A | LGL36600U31X | LJL36600U31X | LLL36600U31X | LRL36600U31X | AL400L61K3 [38] |
| MicroLogic Standard | LSI | 3.3S [35] [37] | 250 A | LGL36250U33X | LJL36250U33X | LLL36250U33X | LRL36250U33X | AL400L61K3 [38] |
| | | | 400 A | LGL36400U33X | LJL36400U33X | LLL36400U33X | LRL36400U33X | AL600LS52K3 |
| | | | 600 A | LGL36600U33X | LJL36600U33X | LLL36600U33X | LRL36600U33X | AL600LS52K3 |
| MicroLogic Ammeter | LSI | 5.3A | 400 A | LGL36400U43X | LJL36400U43X | LLL36400U43X | LRL36400U43X | AL600LS52K3 |
| MicroLogic Energy | LSI | 5.3E | 400 A | LGL36400U53X | LJL36400U53X | LLL36400U53X | LRL36400U53X | |
| MicroLogic Ammeter | LSIG | 6.3A | 400 A | LGL36400U44X | LJL36400U44X | LLL36400U44X | LRL36400U44X | |
| MicroLogic Energy | LSIG | 6.3E [39] | 400 A | LGL36400U54X | LJL36400U54X | LLL36400U54X | LRL36400U54X | |
| | | | 600 A | LGL36600U43X | LJL36600U43X | LLL36600U43X | LRL36600U43X | |
| | | | 600 A | LGL36600U53X | LJL36600U53X | LLL36600U53X | LRL36600U53X | |
| 600 Vac, 50/60 Hz, 4P | | | | | | | | |
| MicroLogic Standard | LI | 3.3 | 250 A | LGL46250U31X | LJL46250U31X | LLL46250U31X | LRL46250U31X | AL400L61K4 |
| | | | 400 A | LGL46400U31X | LJL46400U31X | LLL46400U31X | LRL46400U31X | AL600LS52K4 |
| | | | 600 A | LGL46600U31X | LJL46600U31X | LLL46600U31X | LRL46600U31X | AL400L61K4 |
| MicroLogic Standard | LSI | 3.3S [37] | 250 A | LGL46250U33X | LJL46250U33X | LLL46250U33X | LRL46250U33X | AL400L61K4 |
| | | | 400 A | LGL46400U33X | LJL46400U33X | LLL46400U33X | LRL46400U33X | AL600LS52K4 |
| | | | 600 A | LGL46600U33X | LJL46600U33X | LLL46600U33X | LRL46600U33X | AL600LS52K4 |
| MicroLogic Ammeter | LSI | 5.3A | 400 A | LGL46400U43X | LJL46400U43X | LLL46400U43X | LRL46400U43X | AL600LS52K4 |
| MicroLogic Energy | LSI | 5.3E | 400 A | LGL46400U53X | LJL46400U53X | LLL46400U53X | LRL46400U53X | |
| MicroLogic Ammeter | LSIG | 6.3A | 400 A | LGL46400U44X | LJL46400U44X | LLL46400U44X | LRL46400U44X | |
| MicroLogic Energy | LSIG | 6.3E | 400 A | LGL46400U54X | LJL46400U54X | LLL46400U54X | LRL46400U54X | |
| | | | 600 A | LGL46600U43X | LJL46600U43X | LLL46600U43X | LRL46600U43X | |
| | | | 600 A | LGL46600U53X | LJL46600U53X | LLL46600U53X | LRL46600U53X | |

[32] Circuit breakers with J, L, and R interrupting ratings are UL certified as current limiting.

[33] See Supplemental Digest Section 3 for circuit breakers with field interchangeable trip units.

[34] For applications requiring communications see page 7-68.

[35] 3P circuit breakers with this trip unit can be used for 2P applications.

[36] AL600LS52K3 terminal wire range is (2) 2/0 AWG 500 kcmil Al/Cu

[37] Fixed ST and LT delays.

[38] AL400L61K3 terminal wire ranges are (1) 2 AWG–600 kcmil Cu or (1) 2 AWG–500 kcmil Al.

[39] 3-pole circuit breakers can be used for 2-pole applications. (For such instances, MicroLogic 6.2 Ammeter and Energy trip units can be used for ground fault protection. Additional metering capabilities are not guaranteed when using MicroLogic Ammeter and Energy trip units for this type of application.)

Table 7.64: L-Frame 600 A 100% Rated UL Current-Limiting [40] Circuit Breakers with Lugs and Factory-Sealed Electronic Trip Units Suitable for Reverse Connection [41][42]

| Electronic Trip Unit | | | Sensor Rating | Interrupting Rating (100% Rated) | | | | | Terminal |
|-----------------------|----------|-------------------|---------------|----------------------------------|---------------|---------------|---------------|---------------|-------------|
| Type | Function | Trip Unit | | D | G | J [40] | L [40] | R [40] | |
| 600 Vac, 50/60 Hz, 3P | | | | | | | | | |
| MicroLogic Standard | LI | 3.3 [43] | 250 A | LDL36250CU31X | LGL36250CU31X | LJL36250CU31X | LLL36250CU31X | LRL36250CU31X | AL400L61K3 |
| | | | 400 A | LDL36400CU31X | LGL36400CU31X | LJL36400CU31X | LLL36400CU31X | LRL36400CU31X | AL600LS52K3 |
| MicroLogic Standard | LSI | 3.3S [43] [44] | 250 A | LDL36250CU33X | LGL36250CU33X | LJL36250CU33X | LLL36250CU33X | LRL36250CU33X | AL400L61K3 |
| | | | 400 A | LDL36400CU33X | LGL36400CU33X | LJL36400CU33X | LLL36400CU33X | LRL36400CU33X | AL600LS52K3 |
| MicroLogic Ammeter | LSI | 5.3A | 400 A | LDL36400CU43X | LGL36400CU43X | LJL36400CU43X | LLL36400CU43X | LRL36400CU43X | AL600LS52K3 |
| MicroLogic Energy | LSI | 5.3E | 400 A | LDL36400CU53X | LGL36400CU53X | LJL36400CU53X | LLL36400CU53X | LRL36400CU53X | |
| MicroLogic Ammeter | LSIG | 6.3A | 400 A | LDL36400CU44X | LGL36400CU44X | LJL36400CU44X | LLL36400CU44X | LRL36400CU44X | |
| MicroLogic Energy | LSIG | 6.3E [45] | 400 A | LDL36400CU54X | LGL36400CU54X | LJL36400CU54X | LLL36400CU54X | LRL36400CU54X | |
| 600 Vac, 50/60 Hz, 4P | | | | | | | | | |
| MicroLogic Standard | LI | 3.3 | 250 A | LDL46250CU31X | LGL46250CU31X | LJL46250CU31X | LLL46250CU31X | LRL46250CU31X | AL400L61K4 |
| | | | 400 A | LDL46400CU31X | LGL46400CU31X | LJL46400CU31X | LLL46400CU31X | LRL46400CU31X | AL600LS52K4 |
| MicroLogic Standard | LSI | 3.3S | 250 A | LDL46250CU33X | LGL46250CU33X | LJL46250CU33X | LLL46250CU33X | LRL46250CU33X | AL400L61K4 |
| | | | 400 A | LDL46400CU33X | LGL46400CU33X | LJL46400CU33X | LLL46400CU33X | LRL46400CU33X | AL600LS52K4 |
| MicroLogic Ammeter | LSI | 5.3A | 400 A | LDL46400CU43X | LGL46400CU43X | LJL46400CU43X | LLL46400CU43X | LRL46400CU43X | AL600LS52K4 |
| MicroLogic Energy | LSI | 5.3E | 400 A | LDL46400CU53X | LGL46400CU53X | LJL46400CU53X | LLL46400CU53X | LRL46400CU53X | |
| MicroLogic Ammeter | LSIG | 6.3A | 400 A | LDL46400CU44X | LGL46400CU44X | LJL46400CU44X | LLL46400CU44X | LRL46400CU44X | |
| MicroLogic Energy | LSIG | 6.3E | 400 A | LDL46400CU54X | LGL46400CU54X | LJL46400CU54X | LLL46400CU54X | LRL46400CU54X | |

Table 7.65: PowerPacT L-Frame Terminal Wire Ranges

| Terminal | Wire Range |
|-------------|--|
| AL400L61K3 | (1) 2 AWG–600 kcmil Cu or 1) 2 AWG–500 kcmil Al. |
| AL600LS52K3 | (2) 2/0 AWG–500 kcmil Al/Cu. |

Table 7.66: PowerPacT L-Frame Termination Options

| Termination Letter | Termination Option |
|--------------------|---------------------------------------|
| A | I-Line (See Section 9—Panelboards) |
| F | No lugs |
| L | Lugs both ends |
| M | Lugs ON end, terminal nut kit OFF end |
| P | Lugs OFF end, terminal nut kit ON end |
| N | Plug In |
| D | Drawout |
| S | Rear Connected |

For factory-installed termination, place termination letter in the third block of the circuit breaker catalog number.
Termination Letter
L G L 3 6 6 0 0 U 4 4 X

Table 7.67: PowerPacT L-Frame Interrupting Ratings

| Voltage | Interrupting Rating | | | | |
|---------|---------------------|-------|--------|--------|--------|
| | D | G | J | L | R |
| 240 Vac | 25 kA | 65 kA | 100 kA | 125 kA | 200 kA |
| 480 Vac | 18 kA | 35 kA | 65 kA | 100 kA | 200 kA |
| 600 Vac | 14 kA | 18 kA | 25 kA | 50 kA | 100 kA |

Accessories see page 7-55
 Optional Lugs see page 7-60
 Dimensions see page 7-86
 Enclosures see page 7-87

[40] Circuit breakers with J, L, and R interrupting ratings are UL certified as current limiting.
 [41] See Supplemental Digest Section 3 for circuit breakers with field interchangeable trip units.
 [42] For applications requiring communications see page 7-68.
 [43] 3P circuit breakers with this trip unit can be used for 2P applications.
 [44] Fixed ST and LT delays.
 [45] 3-pole circuit breakers can be used for 2-pole applications. (For such instances, MicroLogic 6.2 Ammeter and Energy trip units can be used for ground fault protection. Additional metering capabilities are not guaranteed when using MicroLogic Ammeter and Energy trip units for this type of application.)



PowerPacT M-Frame Circuit Breaker with Basic Electronic Trip Unit

PowerPacT M-Frame Molded Case Circuit Breakers (800 A)

PowerPacT M-frame circuit breakers use an electronic trip system with the simplicity of a thermal magnetic breaker.

- Basic electronic trip protection from 300 to 800 A up to 600 Vac
- 2- and 3-pole unit mount and I-line construction
- UL listed interrupting ratings from 35 to 65 kA at 480 Vac
- Common mounting holes, handle locations and trim dimensions with shared auxiliaries and accessories with P-frame devices
- Available in standard (80%) rating only
- UL, CSA, NOM, IEC, CCC certified, and UKCA and CE marked for global acceptance

Table 7.68: M-Frame 800 A, Basic Electronic Trip System Type ET 1.0 [46] Factory-Sealed Trip Unit

| Electronic Trip Unit | | Ampere Rating | Adjustable Instantaneous Trip Range | | Interrupting Rating | |
|----------------------|--|---------------|-------------------------------------|------|---------------------|----------|
| Type | Function | | Low | High | G | J |
| 2P, 600 Vac 50/60 Hz | | | | | | |
| Basic | Fixed Long-time, Adjustable Instantaneous Trip | 400 A | 800 | 4000 | MGL26400 | MJL26400 |
| | | 600 A | 1200 | 6000 | MGL26800 | MJL26800 |
| 3P, 600 Vac 50/60 Hz | | | | | | |
| Basic | Fixed Long-time, Adjustable Instantaneous Trip | 400 A | 800 | 4000 | MGL36400 | MJL36400 |
| | | 600 A | 1200 | 6000 | MGL36800 | MJL36800 |

Table 7.69: M-Frame 800 A, Adjustable Amperage Electronic Trip Unit

| Electronic Trip Unit | | Adjustable Long-Time Settings | Adjustable Instantaneous | | Interrupting Rating | |
|----------------------|--|-------------------------------|--------------------------|------|---------------------|-------------|
| Type | Function | | Low | High | G | J |
| 2P, 600 Vac 50/60 Hz | | | | | | |
| Basic | Adjustable Long-Time Adjustable Instantaneous Trip | 300–800 | 2x | 10x | MGL26800E10 | MJL26800E10 |
| 3P, 600 Vac 50/60 Hz | | | | | | |
| Basic | Adjustable Long-Time Adjustable Instantaneous Trip | 300–800 | 2x | 10x | MGL36800E10 | MJL36800E10 |

Table 7.70: M-Frame Termination Options

| Termination Letter | Termination Option |
|--------------------|---------------------------------------|
| A | I-Line (See Section 9—Panelboards) |
| F | No lugs |
| L | Lugs both ends |
| M | Lugs ON end, terminal nut kit OFF end |
| P | Lugs OFF end, terminal nut kit ON end |

M G L 3 6 4 0 0
For factory-installed termination, place termination letter in the third block of the circuit breaker catalog number.

Table 7.71: PowerPacT M-Frame Interrupting Ratings

| Voltage | Interrupting Rating | |
|---------|---------------------|--------|
| | G | J |
| 240 Vac | 65 kA | 100 kA |
| 480 Vac | 35 kA | 65 kA |
| 600 Vac | 18 kA | 25 kA |

Accessories see [page 7-55](#)
Optional Lugs see [page 7-60](#)

Dimensions see [page 7-86](#)
Enclosures see [page 7-87](#)

[46] The ET 1.0 trip unit cannot be field replaced or have the long-time trip point setting adjusted. It is considered an electronic equivalent of a thermal-magnetic circuit breaker.



P-Frame 1200 A Unit-Mount



Electrically Operated P-Frame 800 A Unit-Mount

Table 7.72: P-Frame Interrupting Ratings

| Voltage | P-Frame Interrupting Rating | | | |
|---------|-----------------------------|--------|-------|--------|
| | G | J | K | L |
| 240 Vac | 65 kA | 100 kA | 65 kA | 125 kA |
| 480 Vac | 35 kA | 65 kA | 50 kA | 100 kA |
| 600 Vac | 18 kA | 25 kA | 50 kA | — |

Table 7.73: P-Frame Termination Options

| Termination Letter |
|---|
| A = I-Line (See Section 9—Panelboards) |
| D = Drawout |
| F = No Lugs (Includes terminal nut kit on both ends) |
| L = Lugs both ends |
| M = Lugs ON end, terminal nut kit OFF end |
| P = Lugs OFF end, terminal nut kit ON end |
| P G L 3 6 0 4 0 U 4 1 A |
| For factory-installed termination, place termination letter in the third block of the circuit breaker catalog number. |

Dimensions see page 7-86

Trip Unit Options see page 7-66

Optional Lugs see page 7-60

Alternate Rating Plugs see page 7-68

Enclosures see page 7-87

Accessories see page 7-55

PowerPac P-Frame Molded Case Circuit Breakers (1200 A)

- MicroLogic trip protection from 250 to 1200 A up to 600 Vac
- 2-, 3- and 4-pole unit-mount construction
- UL listed interrupting ratings from 35 kA to 100 kA at 480 Vac
- Same dimensions, common mounting, bussing, cabling and door cut-out as PowerPac M-frame circuit breakers
- Standard (80%) and 100% rating
- UL, CSA, NOM, IEC, CCC certified, and UKCA and CE marked for global acceptance

Table 7.74: P-Frame 1200 A (600 Vac, 50/60 Hz) 3P [47] Circuit Breaker with Electronic Trip Unit

| Type | Electronic Trip Unit | | Sensor Rating | Cat. No. [48] | Terminal Wire Range |
|--|---|-----------|-----------------|---|--|
| | Function | Trip Unit | | | |
| Basic Electronic Trip Unit (Not Interchangeable) | Fixed long-time, Adjustable Instantaneous | ET1.01 | 600 A | P■L36060 | AL800M23K (3) 3/0 AWG–500 kcmil Al or Cu |
| | | | 800 A | P■L36080 | AL1200P25K (4) 3/0 AWG–500 kcmil Al or Cu |
| | | | 1000 A | P■L36100 | |
| | | | 1200 A | P■L36120 | |
| MicroLogic Interchangeable Standard Trip Unit | LI | 3.0 | 250 A | P■L36025(C)U31A | AL800M23K (3) 3/0 AWG–500 kcmil Al or Cu |
| | | | 400 A | P■L36040(C)U31A | |
| | | | 600 A | P■L36060(C)U31A | |
| | | | 800 A | P■L36080(C)U31A | |
| | | | 1000 A | P■L36100(C)U31A | |
| | | | 1200 A | P■L36120(C)U31A | |
| | LSI | 5.0 | 250 A | P■L36025(C)U33A | AL800M23K (3) 3/0 AWG–500 kcmil Al or Cu |
| | | | 400 A | P■L36040(C)U33A | |
| | | | 600 A | P■L36060(C)U33A | |
| | | | 800 A | P■L36080(C)U33A | |
| | | | 1000 A | P■L36100(C)U33A | |
| | | | 1200 A | P■L36120(C)U33A | |
| MicroLogic Interchangeable Ammeter Trip Unit | LI | 3.0A | 250 A | P■L36025(C)U41A | AL800M23K (3) 3/0 AWG–500 kcmil Al or Cu |
| | | | 400 A | P■L36040(C)U41A | |
| | | | 600 A | P■L36060(C)U41A | |
| | | | 800 A | P■L36080(C)U41A | |
| | | | 1000 A | P■L36100(C)U41A | |
| | | | 1200 A | P■L36120(C)U41A | |
| | LSI | 5.0A | 250 A | P■L36025(C)U43A | AL800M23K (3) 3/0 AWG–500 kcmil Al or Cu |
| | | | 400 A | P■L36040(C)U43A | |
| | | | 600 A | P■L36060(C)U43A | |
| | | | 800 A | P■L36080(C)U43A | |
| | | | 1000 A | P■L36100(C)U43A | |
| | | | 1200 A | P■L36120(C)U43A | |
| LSIG | 6.0A | 250 A | P■L36025(C)U44A | AL800M23K (3) 3/0 AWG–500 kcmil Al or Cu | |
| | | 400 A | P■L36040(C)U44A | | |
| | | 600 A | P■L36060(C)U44A | | |
| | | 800 A | P■L36080(C)U44A | | |
| | | 1000 A | P■L36100(C)U44A | | |
| | | 1200 A | P■L36120(C)U44A | | |
| MicroLogic Interchangeable Power Trip Unit | LSI | 5.0P | 250 A | P■L36025(C)U63AE1 | AL800M23K (3) 3/0 AWG–500 kcmil Al or Cu |
| | | | 400 A | P■L36040(C)U63AE1 | |
| | | | 600 A | P■L36060(C)U63AE1 | |
| | | | 800 A | P■L36080(C)U63AE1 | |
| | | | 1000 A | P■L36100(C)U63AE1 | |
| | | | 1200 A | P■L36120(C)U63AE1 | |
| | LSIG | 6.0P | 250 A | P■L36025(C)U64AE1 | AL800M23K (3) 3/0 AWG–500 kcmil Al or Cu |
| | | | 400 A | P■L36040(C)U64AE1 | |
| | | | 600 A | P■L36060(C)U64AE1 | |
| | | | 800 A | P■L36080(C)U64AE1 | |
| | | | 1000 A | P■L36100(C)U64AE1 | |
| | | | 1200 A | P■L36120(C)U64AE1 | |
| MicroLogic Interchangeable Harmonic Trip Unit | LSI | 5.0H | 250 A | P■L36025(C)U73AE1 | AL800M23K (3) 3/0 AWG–500 kcmil Al or Cu |
| | | | 400 A | P■L36040(C)U73AE1 | |
| | | | 600 A | P■L36060(C)U73AE1 | |
| | | | 800 A | P■L36080(C)U73AE1 | |
| | | | 1000 A | P■L36100(C)U73AE1 | |
| | | | 1200 A | P■L36120(C)U73AE1 | |
| | LSIG | 6.0H | 250 A | P■L36025(C)U74AE1 | AL800M23K (3) 3/0 AWG–500 kcmil Al or Cu |
| | | | 400 A | P■L36040(C)U74AE1 | |
| | | | 600 A | P■L36060(C)U74AE1 | |
| | | | 800 A | P■L36080(C)U74AE1 | |
| | | | 1000 A | P■L36100(C)U74AE1 | |
| | | | 1200 A | P■L36120(C)U74AE1 | |

[47] For 2P and 4P information see Catalog 0612CT0101.

[48] To complete the catalog number:

Replace the ■ with the appropriate interrupting rating (G, J, K or L).

For all L interrupting ratings, change the 5th character (voltage rating) from a 6 (600 V) to a 4 (480V). The 480 V AIR is standard 100 kA.

For 100% rated circuit breakers, add a "C" in the 9th character place. For example, the catalog number for a 100% rated trip unit with LI trip functions at 250 A would be PBL36025CU31A.

PowerPac R-Frame Molded Case Circuit Breakers (3000 A)

- MicroLogic electronic trip protection from 600–3000A up to 600 Vac
- 2-, 3- and 4-pole construction
- UL listed interrupting ratings from 35 to 100 kA at 480Vac
- Built-in Modbus protocol
- Standard (80%) and 100% rating
- UL, CSA, NOM, IEC, CCC certified, and UKCA and CE marked for global acceptance



R-Frame Unit-Mount

Table 7.75: R-Frame Interrupting Ratings

| Voltage | R-Frame Interrupting Rating | | | |
|---------|-----------------------------|--------|-------|--------|
| | G | J | K | L |
| 240 Vac | 65 kA | 100 kA | 65 kA | 125 kA |
| 480 Vac | 35 kA | 65 kA | 65 kA | 100 kA |
| 600 Vac | 18 kA | 25 kA | 65 kA | 50 kA |

Table 7.76: R-Frame Termination Options

| Termination Letter |
|---|
| A = I-Line (See Section 9—Panelboards) |
| F = No Lugs (Includes terminal nut kit on both ends) |
| RJ F 3 6 3 0 0 U 4 1 A |
| For factory-installed termination, place termination letter in the third block of the circuit breaker catalog number. |

Dimensions see page 7-86
 Trip Unit Options see page 7-66
 Optional Lugs see page 7-60
 Alternate Rating Plugs see page 7-68
 Enclosures see page 7-87
 Accessories see page 7-55

Table 7.77: R-Frame 3000 A (600 Vac, 50/60 Hz) 3P Circuit Breaker with Electronic Trip Unit

| Type | Function | Trip Unit | Sensor Rating | Cat. No. [50] |
|--|---|-----------|---------------------------|-------------------|
| | | | Electronic Trip Unit [49] | |
| Basic Electronic Trip Unit (Not Interchangeable) | Fixed long-time, Adjustable Instantaneous | ET1.0I | 1200 A | R■F36120 |
| | | | 1600 A | R■F36160 |
| | | | 2000 A | R■F36200 |
| | | | 2500 A | R■F36250 |
| MicroLogic Interchangeable Standard Trip Unit | LI | 3.0 | 600 A | R■F36060(C)U31A |
| | | | 800 A | R■F36080(C)U31A |
| | | | 1000 A | R■F36100(C)U31A |
| | | | 1200 A | R■F36120(C)U31A |
| | | | 1600 A | R■F36160(C)U31A |
| | | | 2000 A | R■F36200(C)U31A |
| | | | 2500 A | R■F36250(C)U31A |
| | | | 3000 A | R■F36300(C)U31A |
| | LSI | 5.0 | 600 A | R■F36060(C)U33A |
| | | | 800 A | R■F36080(C)U33A |
| | | | 1000 A | R■F36100(C)U33A |
| | | | 1200 A | R■F36120(C)U33A |
| | | | 1600 A | R■F36160(C)U33A |
| | | | 2000 A | R■F36200(C)U33A |
| | | | 2500 A | R■F36250(C)U33A |
| | | | 3000 A | R■F36300(C)U33A |
| MicroLogic Interchangeable Anmeter Trip Unit | LI | 3.0A | 600 A | R■F36060(C)U41A |
| | | | 800 A | R■F36080(C)U41A |
| | | | 1000 A | R■F36100(C)U41A |
| | | | 1200 A | R■F36120(C)U41A |
| | | | 1600 A | R■F36160(C)U41A |
| | | | 2000 A | R■F36200(C)U41A |
| | | | 2500 A | R■F36250(C)U41A |
| | | | 3000 A | R■F36300(C)U41A |
| | LSI | 5.0A | 600 A | R■F36060(C)U43A |
| | | | 800 A | R■F36080(C)U43A |
| | | | 1000 A | R■F36100(C)U43A |
| | | | 1200 A | R■F36120(C)U43A |
| | | | 1600 A | R■F36160(C)U43A |
| | | | 2000 A | R■F36200(C)U43A |
| | | | 2500 A | R■F36250(C)U43A |
| | | | 3000 A | R■F36300(C)U43A |
| LSIG | 6.0A | 600 A | R■F36060(C)U44A | |
| | | 800 A | R■F36080(C)U44A | |
| | | 1000 A | R■F36100(C)U44A | |
| | | 1200 A | R■F36120(C)U44A | |
| | | 1600 A | R■F36160(C)U44A | |
| | | 2000 A | R■F36200(C)U44A | |
| | | 2500 A | R■F36250(C)U44A | |
| | | 3000 A | R■F36300(C)U44A | |
| MicroLogic Interchangeable Power Trip Unit | LSI | 5.0P | 600 A | R■F36060(C)U63AE1 |
| | | | 800 A | R■F36080(C)U63AE1 |
| | | | 1000 A | R■F36100(C)U63AE1 |
| | | | 1200 A | R■F36120(C)U63AE1 |
| | | | 1600 A | R■F36160(C)U63AE1 |
| | | | 2000 A | R■F36200(C)U63AE1 |
| | | | 2500 A | R■F36250(C)U63AE1 |
| | | | 3000 A | R■F36300(C)U63AE1 |
| | LSIG | 6.0P | 600 A | R■F36060(C)U64AE1 |
| | | | 800 A | R■F36080(C)U64AE1 |
| | | | 1000 A | R■F36100(C)U64AE1 |
| | | | 1200 A | R■F36120(C)U64AE1 |
| | | | 1600 A | R■F36160(C)U64AE1 |
| | | | 2000 A | R■F36200(C)U64AE1 |
| | | | 2500 A | R■F36250(C)U64AE1 |
| | | | 3000 A | R■F36300(C)U64AE1 |

[49] For 2P and 4P information see Catalog 0612CT0101.
 [50] To complete the catalog number: Replace the ■ with the appropriate interrupting rating (G, J, K or L); For 100% rated circuit breakers, add a "C" in the 9th character place. For example, the catalog number for a 100% rated trip unit with LI trip functions at 2500 A would be RGF36025CU31A.

Table 7.77 R-Frame 3000 A (600 Vac, 50/60 Hz) 3P Circuit Breaker with Electronic Trip Unit (cont'd.)

| Type | Electronic Trip Unit [51] | | Sensor Rating | Cat. No. [52] |
|---|---------------------------|-----------|-------------------|-------------------|
| | Function | Trip Unit | | |
| MicroLogic Interchangeable Harmonic Trip Unit | LSI | 5.0H | 600 A | R■F36060(C)U73AE1 |
| | | | 800 A | R■F36080(C)U73AE1 |
| | | | 1000 A | R■F36100(C)U73AE1 |
| | | | 1200 A | R■F36120(C)U73AE1 |
| | | | 1600 A | R■F36160(C)U73AE1 |
| | | | 2000 A | R■F36200(C)U73AE1 |
| | | | 2500 A | R■F36250(C)U73AE1 |
| | LSIG | 6.0H | 600 A | R■F36060(C)U74AE1 |
| | | | 800 A | R■F36080(C)U74AE1 |
| | | | 1000 A | R■F36100(C)U74AE1 |
| | | | 1200 A | R■F36120(C)U74AE1 |
| | | | 1600 A | R■F36160(C)U74AE1 |
| | | | 2000 A | R■F36200(C)U74AE1 |
| | | | 2500 A | R■F36250(C)U74AE1 |
| | | 3000 A | R■F36300(C)U74AE1 | |

Unit-Mount R-Frame Standard Bus Connection

R-frame circuit breakers can be bus- or cable-connected.

- For cable connections, an optional terminal pad kit RLTB or equivalent bus structure is required.
- RLTB kits comes standard with bus bar connections.

RLTB / RT3B Kits

- RLTB kits are included with 2500 A 100% rated circuit breakers.
- Each kit contains terminal pads for one end of the circuit breaker only
- Has provisions for mounting a maximum of 8 lugs per phase (9 lugs for 3000 A).
- RL3TB kits are included with the 3000 A, 80% and 100% rated circuit breakers.

R-Frame I-Line circuit breakers come with lugs on the load side. (See Panelboards—Section 9).

For other circuit breakers, order terminal pad kit (RLTB) and optional lugs separately. See [Terminal Nuts](#), [Terminal Pads](#), [Terminal Shields and Accessories](#), page 7-63 and [Mechanical Lugs](#), page 7-60.

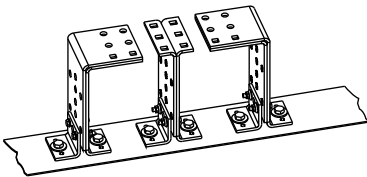

RLTB Terminal Pad Kit

[51] For 2P and 4P information see Catalog 0612CT0101.

[52] To complete the catalog number: Replace the ■ with the appropriate interrupting rating (G, J, K or L.); For 100% rated circuit breakers, add a "C" in the 9th character place. For example, the catalog number for a 100% rated trip unit with LI trip functions at 2500 A would be RGF36025CU31A.



PowerPac J-Frame

PowerPac Mission Critical Circuit Breakers

Delivering high levels of selective coordination in a flexible design that can be easily configured for a variety of applications.

- Adjustable long-time settings in three sensor sizes provide coverage from 70-600 A on 120-240, 208Y/120, 240, and 480Y/277 Vac systems
- Undergone rigorous testing procedures to certify the coordination with downstream circuit breakers
- Available in J-Frame (250A) and L-Frame (600A)
- UL 489 listed, CSA Certified Voltage: 480Y/277V

Table 7.78: J-Frame 250 A Electronic Trip Mission Critical 80% Rated Circuit Breakers (480/277 Vac) with Factory Sealed Trip Units Suitable for Reverse Connection

| Electronic Trip Unit Type | Trip Function | Trip Unit | Continuous Current | Cat. No. | | | | Terminal |
|---------------------------|---------------|-----------|--------------------|----------------|----------------|----------------|----------------|-------------|
| | | | | D Interrupting | G Interrupting | J Interrupting | L Interrupting | |
| Standard | LI | 3.2 W | 250 A | JDL34250WU31X | JGL34250WU31X | JJL34250WU31X | JLL34250WU31X | AL250JD [1] |
| Standard | LSI | 3.2S-W | 250 A | JDL34250WU33X | JGL34250WU33X | JJL34250WU33X | JLL34250WU33X | AL250JD [1] |
| High Perf. Ammeter | LSI | 5.2A-W | 250 A | JDL34250WU43X | JGL34250WU43X | JJL34250WU43X | JLL34250WU43X | AL250JD [1] |
| High Perf. Energy | LSI | 5.2E-W | 250 A | JDL34250WU53X | JGL34250WU53X | JJL34250WU53X | JLL34250WU53X | AL250JD [1] |
| High Perf. Ammeter | LSIG | 6.2A-W | 250 A | JDL34250WU44X | JGL34250WU44X | JJL34250WU44X | JLL34250WU44X | AL250JD [1] |
| High Perf. Energy | LSIG | 6.2E-W | 250 A | JDL34250WU54X | JGL34250WU54X | JJL34250WU54X | JLL34250WU54X | AL250JD [1] |

Table 7.79: L-Frame 600 A Electronic Trip Mission Critical Circuit Breakers (480/277 Vac) with Factory Sealed Trip Units Suitable for Reverse Connection [2]

| Electronic Trip Unit Type | Trip Function | Trip Unit | Continuous Current | Cat. No. | | | | Terminal |
|---------------------------|---------------|-----------|--------------------|----------------|----------------|----------------|-----------------|-----------------|
| | | | | D Interrupting | G Interrupting | J Interrupting | L Interrupting. | |
| 480/277 Vac, 50/60 Hz, 3P | | | | | | | | |
| Standard | LI | 3.3 W | 250 A | LDL34250WU31X | LGL34250WU31X | LJL34250WU31X | LLL34250WU31X | AL400L61K3 [3] |
| | | | 400 A | LDL34400WU31X | LGL34400WU31X | LJL34400WU31X | LLL34400WU31X | AL600LS52K3 [4] |
| | | | 600 A | LDL34600WU31X | LGL34600WU31X | LJL34600WU31X | LLL34300WU31X | |
| Standard | LSI | 3.3S-W | 250 A | LDL34250WU33X | LGL34250WU33X | LJL34250WU33X | LLL34250WU33X | AL400L61K3 [3] |
| | | | 400 A | LDL34400WU33X | LGL34400WU33X | LJL34400WU33X | LLL34400WU33X | AL600LS52K3 [4] |
| | | | 600 A | LDL34600WU33X | LGL34600WU33X | LJL34600WU33X | LLL34300WU33X | |
| High Perf. Ammeter | LSI | 5.3A-W | 400 A | LDL34400WU43X | LGL34400WU43X | LJL34400WU43X | LLL34400WU43X | AL600LS52K3 [4] |
| | | | 600 A | LDL34600WU43X | LGL34600WU43X | LJL34600WU43X | LLL34300WU43X | |
| | | | 400 A | LDL34400WU53X | LGL34400WU53X | LJL34400WU53X | LLL34400WU53X | AL600LS52K3 [4] |
| High Perf. Energy | LSI | 5.3E-W | 600 A | LDL34600WU53X | LGL34600WU53X | LJL34600WU53X | LLL34300WU53X | AL600LS52K3 [4] |
| | | | 400 A | LDL34400WU44X | LGL34400WU44X | LJL34400WU44X | LLL34400WU44X | AL600LS52K3 [4] |
| | | | 600 A | LDL34600WU44X | LGL34600WU44X | LJL34600WU44X | LLL34300WU44X | |
| High Perf. Ammeter | LSIG | 6.3A-W | 400 A | LDL34400WU54X | LGL34400WU54X | LJL34400WU54X | LLL34400WU54X | AL600LS52K3 [4] |
| | | | 600 A | LDL34600WU54X | LGL34600WU54X | LJL34600WU54X | LLL34300WU54X | |
| | | | 400 A | LDL34400WU54X | LGL34400WU54X | LJL34400WU54X | LLL34400WU54X | AL600LS52K3 [4] |
| High Perf. Energy | LSIG | 6.3E-W | 600 A | LDL34600WU54X | LGL34600WU54X | LJL34600WU54X | LLL34300WU54X | AL600LS52K3 [4] |
| | | | 400 A | LDL34400WU54X | LGL34400WU54X | LJL34400WU54X | LLL34400WU54X | AL600LS52K3 [4] |
| | | | 600 A | LDL34600WU54X | LGL34600WU54X | LJL34600WU54X | LLL34300WU54X | |
| 480/277 Vac, 50/60 Hz, 4P | | | | | | | | |
| Standard | LI | 3.3 W | 250 A | LDL44250WU31X | LGL44250WU31X | LJL44250WU31X | LLL44250WU31X | AL400L61K4 [3] |
| | | | 400 A | LDL44400WU31X | LGL44400WU31X | LJL44400WU31X | LLL44400WU31X | AL600LS52K4 [4] |
| | | | 600 A | LDL44600WU31X | LGL44600WU31X | LJL44600WU31X | LLL44300WU31X | |
| Standard | LSI | 3.3S-W | 250 A | LDL44250WU33X | LGL44250WU33X | LJL44250WU33X | LLL44250WU33X | AL400L61K4 [3] |
| | | | 400 A | LDL44400WU33X | LGL44400WU33X | LJL44400WU33X | LLL44400WU33X | AL600LS52K4 [4] |
| | | | 600 A | LDL44600WU33X | LGL44600WU33X | LJL44600WU33X | LLL44300WU33X | |
| High Perf. Ammeter | LSI | 5.3A-W | 400 A | LDL44400WU43X | LGL44400WU43X | LJL44400WU43X | LLL44400WU43X | AL600LS52K4 [4] |
| | | | 600 A | LDL44600WU43X | LGL44600WU43X | LJL44600WU43X | LLL44300WU43X | |
| | | | 400 A | LDL44400WU53X | LGL44400WU53X | LJL44400WU53X | LLL44400WU53X | AL600LS52K3 [4] |
| High Perf. Energy | LSI | 5.3E-W | 600 A | LDL44600WU53X | LGL44600WU53X | LJL44600WU53X | LLL44300WU53X | AL600LS52K3 [4] |
| | | | 400 A | LDL44400WU44X | LGL44400WU44X | LJL44400WU44X | LLL44400WU44X | AL600LS52K4 [4] |
| | | | 600 A | LDL44600WU44X | LGL44600WU44X | LJL44600WU44X | LLL44300WU44X | |
| High Perf. Ammeter | LSIG | 6.3A-W | 400 A | LDL44400WU54X | LGL44400WU54X | LJL44400WU54X | LLL44400WU54X | AL600LS52K4 [4] |
| | | | 600 A | LDL44600WU54X | LGL44600WU54X | LJL44600WU54X | LLL44300WU54X | |
| | | | 400 A | LDL44400WU54X | LGL44400WU54X | LJL44400WU54X | LLL44400WU54X | AL600LS52K4 [4] |
| High Perf. Energy | LSIG | 6.3E-W | 600 A | LDL44600WU54X | LGL44600WU54X | LJL44600WU54X | LLL44300WU54X | AL600LS52K4 [4] |
| | | | 400 A | LDL44400WU54X | LGL44400WU54X | LJL44400WU54X | LLL44400WU54X | AL600LS52K4 [4] |
| | | | 600 A | LDL44600WU54X | LGL44600WU54X | LJL44600WU54X | LLL44300WU54X | |

Table 7.80: Terminal Wire Ranges

| Terminal | Wire Range |
|-------------|---|
| AL250JD | (1) 3/0 AWG-350 kcmil AL or Cu |
| AL400L61K3 | (1) #2 AWG-500 kcmil Al or (1) #2 AWG-600 kcmil Cu. |
| AL600LS52K3 | (2) 2/0 AWG-500 kcmil Al or Cu. |

Accessories see page 7-55

Optional Lugs see page 7-60

Compression and PDC Lugs see Supplemental Digest, Section 3

Dimensions see page 7-86

Enclosures see page 7-87

Table 7.81: J- and L-Frame Termination Options

| Termination Letter | |
|--|---|
| A = I-Line (See Section 9) | J G L 3 6 1 0 0 |
| F = No Lugs (includes terminal nut kit on both ends) [5] | For factory-installed termination, place termination letter in the third block of the circuit breaker catalog number. |
| L = Lugs both ends | Termination Letter |
| M = Lugs ON end Terminal Nut Kit OFF end | |
| P = Lugs OFF end Terminal Nut Kit ON end | |
| N = Plug-in | |
| D = Drawout | |
| S = Rear Connected | |

Table 7.82: J- and L-Frame Interrupting Ratings

| Voltage | Interrupting Rating | | | |
|---------|---------------------|-------|--------|--------|
| | D | G | J | L |
| 240 Vac | 25 kA | 65 kA | 100 kA | 125 kA |
| 480 Vac | 18 kA | 35 kA | 65 kA | 100 kA |

[1] AL250JD terminal wire range is (1) 3/0 AWG-350 kcmil Al or Cu.

[2] 100% rated for 250 A and 400 A. 80% rated for 600 A.

[3] AL400L61K3 terminal wire ranges are (1) #2 AWG-500 kcmil Al or (1) #2 AWG-600 kcmil Cu.

[4] AL600LS52K3 terminal wire ranges are (2) 2/0 AWG-500 kcmil Al or Cu.

[5] Add TS suffix for circuit breaker without terminal nut kit.

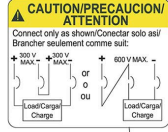

Connection Diagram

Table 7.83: 500 Vdc Termination Options

| Termination Letter | Termination Option |
|--------------------|------------------------------|
| F | No Lugs (bus bar connection) |
| L | Lugs Both Ends |
| S | Rear Connection |

JGL37125D81—Place termination letter in third block of circuit breaker catalog number.

PowerPacT 500 Vdc Circuit Breakers

Designed for use on ungrounded dc systems having a maximum short-circuit voltage of 500 Vdc or a maximum floating (unloaded) voltage of 600 Vdc. Suitable for use only with UPS (ungrounded uninterruptible power supplies systems).

This two-level voltage rating allows these circuit breakers to be applied to battery sources having a short-circuit availability of 20,000 amperes or 50,000 amperes for PowerPacT H-, J-, and L-frame DC circuit breakers at 500 Vdc. IEC 500 Vdc rating is available on PowerPacT J-frame circuit breakers.

PowerPacT H-frame DC circuit breakers have a fixed magnetic trip system. PowerPacT J- and L-frame DC circuit breakers are provided with an adjustable magnetic trip that is readily accessible by means of a single adjustment on the face of the circuit breaker.

PowerPacT H- and J-frame circuit breakers are UL Listed for the interrupting ratings shown only if applied with three poles connected in series (series connection is external to circuit breaker). (See figure for example of diagram.)

PowerPacT L-frame circuit breakers are UL Listed for the interrupting ratings shown with two or three poles connected in series (series connection is external to circuit breaker).

NOTE: Due to external series connection, I-Line™ circuit breakers are not available for this application.

Table 7.84: 500 Vdc Molded Case Circuit Breakers

| Ampere Rating | Circuit Breaker Cat. No. | Fixed Magnetic Trip —DC Amperes | Adjustable Magnetic Trip Range—DC Amperes [1] | | Interrupting Rating @ 500 Vdc |
|---------------|--------------------------|---------------------------------|---|------|-------------------------------|
| | | | Low | High | |
| 30 A | HGL37030D87 | 450 | — | — | 20 k AIR |
| 50 A | HGL37050D87 | 450 | — | — | |
| 70 A | HGL37070D87 | 450 | — | — | |
| 100 A | JGL37100D81 | — | 400 | 600 | 20 k AIR |
| 125 A | JGL37125D81 | — | 400 | 600 | |
| 150 A | JGL37150D81 | — | 400 | 600 | |
| 175 A | JGL37175D81 | — | 400 | 600 | |
| 200 A | JGL37200D82 | — | 500 | 850 | |
| 225 A | JGL37225D82 | — | 500 | 850 | 20 k AIR |
| 250 A | JGL37250D82 | — | 500 | 850 | |
| 300 A | LGL37030D27 | — | 750 | 1500 | |
| 350 A | LGL37035D29 | — | 875 | 1750 | |
| 400 A | LGL37040D30 | — | 1000 | 2000 | |
| 450 A | LGL37045D31 | — | 1125 | 2250 | |
| 500 A | LGL37050D32 | — | 1250 | 2500 | |
| 600 A | LGL37060D33 | — | 1500 | 3000 | |
| 700 A | LGL47070D35 | — | 1750 | 3500 | |
| 800 A | LGL47080D36 | — | 2000 | 4000 | |
| 900 A | LGL47090D86 | — | 2250 | 4500 | |
| 1000 A | LGL47100D40 | — | 2500 | 5000 | |
| 1200 A | LGL47120D42 | — | 3000 | 6000 | |
| 30A | HLL37030D87 | 450 | — | — | 50 k AIR |
| 50A | HLL37050D87 | 450 | — | — | |
| 70A | HLL37070D87 | 450 | — | — | |
| 100A | JLL37100D81 | — | 400 | 600 | 50 k AIR |
| 125A | JLL37125D81 | — | 400 | 600 | |
| 150A | JLL37150D81 | — | 400 | 600 | |
| 175A | JLL37175D81 | — | 400 | 600 | |
| 200A | JLL37200D82 | — | 500 | 850 | |
| 225A | JLL37225D82 | — | 500 | 850 | |
| 250A | JLL37250D82 | — | 500 | 850 | |
| 300A | LLL37030D27 | — | 750 | 1500 | 50 k AIR |
| 350A | LLL37035D29 | — | 875 | 1750 | |
| 400A | LLL37040D30 | — | 1000 | 200 | |
| 450 A | LLL36045D31 | — | 1125 | 2250 | |
| 500 A | LLL37050D32 | — | 1250 | 2500 | |
| 600 A | LLL37060D33 | — | 1500 | 3000 | |
| 700 A | LLL47070D35 | — | 1750 | 3500 | |
| 800 A | LLL47080D36 | — | 2000 | 4000 | |
| 900 A | LLL47090D86 | — | 2250 | 4500 | |
| 1000 A | LLL47100D40 | — | 2500 | 5000 | |
| 1200 A | LLL47120D42 | — | 3000 | 6000 | |

Accessories see page 7-55 and Supplemental Digest Section 3
 Optional Lugs see page 7-60 and Supplemental Digest Section 3
 Dimensions see page 7-86 and Supplemental Digest Section 3
 Enclosures see page 7-90

[1] Magnetic trip tolerances are -20%/+30% from the nominal values shown.

PowerPacT Automatic Switches

Automatic molded case switches open instantaneously at a factory preset magnetic trip point. Calibrated to protect only the molded case switch itself, when it is subjected to high fault currents. The trip point is nonadjustable and provides no overload or low level fault protection.



J-Frame Switch



L-Frame Switch

- PowerPacT™ H-, J-, and L-frame automatic switches are available in unit mount, I-Line™, plug-in and drawout versions.
- Accept the same lugs and accessories as equivalent thermal-magnetic circuit breakers^[1].
- May be interlocked with another switch or circuit breaker to form a source-changeover system
- UL Listed per UL 489 and CSA Certified.

Table 7.85: PowerPacT™ B-Frame Automatic Molded Case Switches, 600 Vac

| Circuit Breaker | Poles | Ampere Rating | D Withstand | | G Withstand | | J Withstand | | Terminal | Wire Range |
|-----------------|-------|---------------|-------------|------------|-------------|------------|-------------|------------|----------|---------------|
| | | | Cat. No. | Trip Point | Cat. No. | Trip Point | Cat. No. | Trip Point | | |
| B-Frame | 2 [2] | 125 A | BDL26000S12 | 1625 A | BGL26000S12 | 1625 A | BJL26000S12 | 1625 A | LV426973 | 14–2/0 AWG Cu |
| | 3 | 125 A | BDL36000S12 | 1625 A | BGL36000S12 | 1625 A | BJL36000S12 | 1625 A | LV426974 | 14–2/0 AWG Cu |

Table 7.86: H-, J-, and L-Frame PowerPacT™ Automatic Molded Case Switches, 600 Vac

| Circuit Breaker | Poles | Ampere Rating | G Withstand | | L Withstand | | R Withstand | | Terminal | Wire Range |
|--------------------|-------|---------------|-----------------|------------|--------------|------------|--------------|------------|----------|-----------------------------|
| | | | Cat. No. | Trip Point | Cat. No. | Trip Point | Cat. No. | Trip Point | | |
| H-Frame J-Frame | 2 | 150 A | HGL26000S15 [2] | 2250 A | HLL26000S15 | 2250 A | — | — | AL150HD | 14 AWG–3/0 AWG Al/Cu |
| | | 175 A | JGL26000S17 | 3125 A | JLL26000S17 | 3125 A | — | — | AL175JD | 4–4/0 AWG Al/Cu |
| | | 250 A | JGL26000S25 | 3125 A | JLL26000S25 | 3125 A | — | — | AL250JD | 3/0 AWG–350 kcmil Al/Cu |
| | 3 | 150 A | HGL36000S15 | 2250 A | HLL36000S15 | 2250 A | — | — | AL150HD | 14 AWG–3/0 AWG Al/Cu |
| | | 175 A | JGL36000S17 | 3125 A | JLL36000S17 | 3125 A | JRL36000S17 | 3125 A | AL175JD | 4–4/0 AWG Al/Cu |
| | | 250 A | JGL36000S25 | 3125 A | JLL36000S25 | 3125 A | JRL36000S25 | 3125 A | AL250JD | 3/0 AWG–350 kcmil Al/Cu |
| L-Frame | 3 | 400 A | LGL36000S40X | 4800 A | LLL36000S40X | 4800 A | LRL36000S40X | 4800 A | AL150HD | AL600LS2K3 |
| | | 600 A | LGL36000S60X | 6600 A | LLL36000S60X | 6600 A | LRL36000S60X | 6600 A | AL250JD | (2) 2/0 AWG–500 kcmil Al/Cu |
| | 4 | 400 A | LGL46000S40X | 4800 A | LLL46000S40X | 4800 A | LRL46000S40X | 4800 A | AL150HD | AL600LS2K4 |
| | | 600 A | LGL46000S60X | 6600 A | LLL46000S60X | 6600 A | LRL46000S60X | 6600 A | AL250JD | (2) 2/0 AWG–500 kcmil Al/Cu |

Table 7.87: P-Frame and R-Frame PowerPacT™ Automatic Molded Case Switches [3], 600 Vac

| Frame | Poles | Ampere Rating | J Withstand | | K Withstand | | L Withstand | | Terminal | Wire Range |
|--------|-------|---------------|-------------|------------|-------------|------------|-----------------|------------|------------|--------------------------------|
| | | | Cat. No. | Trip Point | Cat. No. | Trip Point | Cat. No. | Trip Point | | |
| M | 2 | 800 A | MJL26000S80 | 10 kA | — | — | — | — | AL800M23K | (3) 3/0 AWG–500 kcmil Al or Cu |
| | 3 | 800 A | MJL36000S80 | 10 kA | — | — | — | — | AL800M23K | (3) 3/0 AWG–500 kcmil Al or Cu |
| P | 2 | 600 A | PJL26000S60 | 10 kA | PKL26000S60 | 24 kA | PLL24000S60 [4] | 10 kA | AL800M23K | (3) 3/0 AWG–500 kcmil Al or Cu |
| | | 800 A | PJL26000S80 | 10 kA | PKL26000S80 | 24 kA | PLL24000S80 [4] | 10 kA | | |
| | | 1000 A | PJL26000S10 | 10 kA | PKL26000S10 | 24 kA | PLL24000S10 [4] | 10 kA | | |
| | 3 | 1200 A | PJL26000S12 | 10 kA | PKL26000S12 | 24 kA | PLL24000S12 [4] | 10 kA | AL1200P25K | (4) 3/0 AWG–500 kcmil Al or Cu |
| | | 600 A | PJL36000S60 | 10 kA | PKL36000S60 | 24 kA | PLL34000S60 [4] | 10 kA | | |
| | | 800 A | PJL36000S80 | 10 kA | PKL36000S80 | 24 kA | PLL34000S80 [4] | 10 kA | | |
| R | 2 | 1000 A | PJL36000S10 | 10 kA | PKL36000S10 | 24 kA | PLL34000S10 [4] | 10 kA | AL1200P25K | (4) 3/0 AWG–500 kcmil Al or Cu |
| | | 1200 A | PJL36000S12 | 10 kA | PKL36000S12 | 24 kA | PLL34000S12 [4] | 10 kA | | |
| | | 1200 A | — | — | RKF26000S12 | 57 kA | RLF26000S12 | 48 kA | | |
| | 3 | 1600 A | — | — | RKF26000S16 | 57 kA | RLF26000S16 | 48 kA | | |
| | | 2000 A | — | — | RKF26000S20 | 57 kA | RLF26000S20 | 48 kA | | |
| | | 2500 A | — | — | RKF26000S25 | 57 kA | RLF26000S25 | 48 kA | | |
| | | 1200 A | — | — | RKF36000S12 | 57 kA | RLF36000S12 | 48 kA | | |
| | | 1600 A | — | — | RKF36000S16 | 57 kA | RLF36000S16 | 48 kA | | |
| | | 2000 A | — | — | RKF36000S20 | 57 kA | RLF36000S20 | 48 kA | | |
| 2500 A | — | — | RKF36000S25 | 57 kA | RLF36000S25 | 48 kA | | | | |
| 3000 A | — | — | RKF36000S30 | 57 kA | RLF36000S30 | 48 kA | | | | |

R-frame circuit breakers can be bus-connected or cable-connected. For cable connections, RLTB kit or equivalent bus structure is required. Kit is included with 3000 A switches. For all others, see page 7-63.

Table 7.88: Q-Frame (240 Vac) PowerPacT™ Automatic Molded Case Switches

| Circuit Breaker | Poles | Ampere Rating | J Withstand | | Wire Range |
|-----------------|-------|---------------|-------------|------------|-----------------|
| | | | Cat. No. | Trip Point | |
| Q-Frame [5] | 2 | 225 A | QBL22000S22 | 4500 A | 4 AWG–300 kcmil |
| | 3 | 225 A | QBL32000S22 | 4500 A | |

Table 7.89: B-, H-, J-, L- P-, and R-Frame Withstand Ratings [6]

| Voltage | Withstand | | | | | |
|---------|-----------|-------|--------|-----------|--------|--------|
| | D | G | J | K | L | R |
| 240 Vac | 25 kA | 65 kA | 100 kA | 65 kA | 125 kA | 200 kA |
| 480 Vac | 18 kA | 35 kA | 65 kA | 50 kA [7] | 100 kA | 200 kA |
| 600 Vac | 14 kA | 18 kA | 25 kA | 50 kA [7] | 50 kA | 100 kA |

Accessories see page 7-55 and Supplemental Digest Section 3
Optional Lugs see page 7-60 and Supplemental Digest Section 3
Dimensions see page 7-85 and page 7-86
Enclosures see page 7-87

[1] Q-frame switches do not have electrical accessories available.

[2] True 2P device. Others are a 2P in a 3P module.

[3] UL magnetic trip tolerances are -20% / +30% from the nominal values shown.

[4] P-frame L-interrupting is available in 480 Vac only.

[5] Withstand rating of 10 kA at 240 Vac.

[6] The withstand rating is the fault current at rated voltage that the molded case switch will withstand without damage when protected by a circuit breaker with an equal continuous current rating.

[7] B- and R-frame withstand is 65 kA.



Instantaneous Trip Circuit Breakers for Motor Protection Applications

Adjustable instantaneous-trip circuit breakers are intended for use in combination with motor starters with overload relays for the protection of motor circuits from short circuits.

Other specific applications include rectifiers and resistance welders. These circuit breakers contain a magnetic trip element in each pole with the trip point adjustable from the front. Interrupting ratings are determined by testing the instantaneous-trip circuit breakers in combination with a contactor and overload relay.

Select instantaneous-trip circuit breakers as follows:

This selection table is suitable for motors, other than NEMA Design E, with locked-rotor indicating code letters per NEC® Table 430.7 (b) as follows:

Table 7.90: Locked-Rotor Indicating Codes

| Horsepower | Motor Code Letter |
|--------------|-------------------|
| 1/2 or less | A-L |
| 3/4 to 1-1/2 | A-K |
| 2 to 3 | A-J |
| 5 to 25 | A-H |
| 30 to 125 | A-G |
| 150 or more | A-F |

- For other motors order a special thermal-magnetic circuit breaker with magnetic trip settings for the specific motor— specify motor horsepower, voltage, frequency, full-load current and code letter or locked rotor current.
- Determine motor hp rating from the motor nameplate.
- Refer to the tables and select an instantaneous-trip circuit breaker with an ampere rating recommended for the hp and voltage involved.
- Select an adjustable trip setting of at least 800%, not to exceed 1300%, of the motor full-load amperes (FLA) for other than Design E motors. For Design E motors, select an adjustable trip setting of at least 1100% not to exceed 1700% of FLA.
- The NEC 1300% maximum setting may be inadequate for instantaneous-trip circuit breakers to withstand current surges typical of the magnetization current of autotransformer type reduced voltage starters, or open transition wye-delta starters during transfer from “start” to “run,” constant hp multi-speed motors, and motors labeled “high efficiency.” Select thermal-magnetic circuit breakers for those applications.
- Part-winding motors, per NEC 430.4, should have two circuit breakers selected from the above at not more than one half the allowable trip setting for the horsepower rating. The two circuit breakers should operate simultaneously as a disconnecting means per NEC 430.103.
- Based on NEC 430.52 and NEC Table 430.250.

Table 7.91: Selection Tables for Conductors, Safety Switches and Thermal-Magnetic Circuit Breakers
Based on 2017 NEC® Tables 430.247, 430.248 & 430.250

| Horsepower Ratings | | | | | | | | | | Full Load Amperage [1] | Amperage of Thermal-Magnetic [2] Inverse Time Circuit Breaker | | | QMB and Heavy Duty Switch with Time Delay Fuses [3] | Minimum Size metallic Conduit 75° C, C Wire Field-Installed Sized for 125% FLA [4] | | | | | | | | | | | | | | | | | | | | | | | | | | | | | | | | | | | | | | | | | | | | | | | | | | | | | | | | | | | | | | | | | | | | | | | | | | | | | | | | | | | | | | | | | | | | | | | | | | | | | | | | | | | | | | | | | | | | | | | | | | | | | | | | | | | | | | | | | | | | | | | | | | | | | | | | | | | | | | | | | | | | | | | | | | | | | | | | | | | | | | | | | | | | | | | | | | | | | | | | | | | | | | | | | | | | | | | | | | | | | | | | | | | | | | | | | | | | | | | | | | | | | | | | | | | | | | | | | | | | | | | | | | | | | | | | | | | | | | | | | | | | | | | | | | | | | | | | | | | | | | | | | | | | | | | | | | | | | | | | | | | | | | | | | | | | | | | | | | | | | | | | | | | | | | | | | | | | | | | | | | | | | | | | | | | | | | | | | | | | | | | | | | | | | | | | | | | | | | | | | | | | | | | | | | | | | | | | | | | | | | | | | | | | | | | | | | | | | | | | | | | | | | | | | | | | | | | | | | | | | | | | | | | | | | | | | | | | | | | | | | | | | | | | | | | | | | | | | | | | | | | | | | | | | | | | | | | | | | | | | | | | | | | | | | | | | | | | | | | | | | | | | | | | | | | | | | | | | | | | | | | | | | | | | | | | | | | | | | | | | | | | | | | | | | | | | | | | | | | | | | | | | | | | | | | | | | | | | | | | | | | | | | | | | | | | | | | | | | | | | | | | | | | | | | | | | | | | | | | | | | | | | | | | | | | | | | | | | | | | | | | | | | | | | | | | | | | | | | | | | | | | | | | | | | | | | | | | | | | | | | | | | | | | | | | | | | | | | | | | | | | | | | | | | | | | | | | | | | | |
|--|-------|----|-------|-------------|-------------|---------|---|------------------------------|----------------------|------------------------|---|-----------|--|---|--|-------|-------|-------|-------|---|--------|-------|--------|---|-------|-------|-------|-------|-------|-------|---|--------|-------|--------|---|-------|-------|-------|-------|-------|-------|--|--------|-------|--------|---|-------|-------|-------|-------|-------|-------|--|--------|-------|--------|---|-------|-------|-------|-------|-------|-------|-------|--------|-------|--------|---|-------|-------|-------|-------|-------|-------|-------|--------|-------|--------|---|-------|-------|-------|-------|-------|-------|-------|--------|-------|--------|--|----|--------|-------|-------|-------|-------|-------|--------|-------|--------|--|----|--------|-------|-------|-------|-------|-------|--------|-------|--------|--|---|--------|-------|-------|-------|-------|-------|--------|-------|--------|---|---|--------|-------|-------|-------|-------|-----|--------|-------|--------|---|---|--------|-------|-------|-------|-------|-----|--------|-------|--------|---|--|--------|-------|-------|-------|-------|-----|--------|-------|--------|---|--|--------|-------|-------|-------|-------|-----|--------|-------|--------|---|-------|--------|-------|-------|-------|-------|-----|--------|-------|--------|---|-------|--------|-------|-------|-------|-------|--|--------|-------|--------|--|-------|--------|-------|-------|-------|-------|--|--------|-------|--------|---|-------|--------|-------|-------|-------|-------|---|--------|----|--------|-------|-------|--------|-------|-------|-------|-------|---|--------|----|--------|-------|-------|--------|-------|-------|-------|-------|---|--------|----|--------|-------|----|--------|-------|-------|-------|-------|---|--------|----|--------|-------|----|--------|-------|-------|-------|----|---|--------|----|--------|-------|----|--------|-------|-------|-------|----|---|--------|----|--------|-------|----|--------|-------|-------|-------|----|---|--------|----|--------|----|----|--------|-------|-------|-------|----|---|--------|----|--------|----|----|--------|-------|-------|-------|----|---|--------|----|--------|----|--|--------|-------|-------|-------|-------|---|--------|----|--------|----|--|--------|-------|-------|-------|-------|---|--------|----|--------|-------|----|--------|-------|-------|-------|-------|---|--------|----|--------|-------|----|--------|-------|----|-------|-------|---|--------|----|--------|-------|----|--------|-------|----|-------|-------|---|--------|----|--------|-------|----|--------|-------|----|-------|-------|---|--------|----|--------|-------|----|--------|-------|----|-------|-------|--|--------|-------|--------|----|----|--------|-------|----|-------|-------|--|--------|-------|--------|----|--|--------|-------|----|-------|-------|--|--------|-------|--------|----|--|--------|-------|----|-------|----|--|--------|-------|--------|--|--|--------|-------|----|-------|----|--|--------|-------|--------|--|--|--------|-------|----|---|----|-------|--------|-------|--------|--|--|--------|-------|----|---|----|-------|--------|-------|--------|----|--|--------|-------|--|---|----|-------|--------|-------|--------|----|--|--------|-------|--|---|----|-------|--------|----|--------|----|--|--------|-------|--|--|----|-------|--------|----|--------|----|--|--------|-------|--|--|----|-------|--------|----|--------|----|--|--------|-------|--|--|----|--|--------|----|--------|----|--|--------|-------|--|--|----|--|--------|----|--------|----|--|--------|-------|--|--|----|--|--------|----|--------|----|--|--------|-------|--|--|----|--|--------|----|--------|----|--|--------|----|--|-------|----|--|-------|--|--------|----|--|--------|----|--|-------|--|--|-------|--|--------|----|--|--------|----|--|-------|--|--|-------|--|--------|----|--|--------|--|--|-------|--|--|-------|--|--------|----|--|--------|--|--|-------|--|--|-------|--|--------|----|--|--------|----|--|-------|--|--|-------|--|--------|----|--|--------|----|--|--|--|--|-------|--|-------|--|--|--------|----|--|--|--|--|-------|--|-------|----|--|--------|----|--|--|--|--|-------|--|-------|----|--|--------|----|--|--|--|--|-------|--|-------|----|--|--------|--|--|--|--|--|-------|--|-------|----|--|--------|--|--|--|--|--|--|--|-------|----|--|-------|--|--|--|--|--|--|--|-------|--|--|-------|--|--|--|--|--|--|--|-------|--|--|-------|--|--|--|--|--|--|--|-------|--|--|-------|--|--|--|--|--|--|--|-------|--|--|-------|--|--|--|--|--|--|--|-------|--|--|-------|--|--|--|--|--|--|--|--|--|--|-------|--|--|--|--|--|--|--|--|--|--|-------|--|--|--|--|--|--|--|--|--|--|-------|--|--|--|--|--|--|--|--|--|--|-------|--|--|--|--|--|--|--|--|--|--|-------|
| Squirrel-Cage and Wound-Rotor Motors with Norm. Torque Characteristics Operating at Usual Speeds | | | | 1Ø 10 Hz ac | | | Average Direct Current Motors Operating at Base Speed | For Motor Code Letter B to E | | | For Motor Code Letter F to V [5] | AWG kcmil | Conduit 3 W | | | | | | | | | | | | | | | | | | | | | | | | | | | | | | | | | | | | | | | | | | | | | | | | | | | | | | | | | | | | | | | | | | | | | | | | | | | | | | | | | | | | | | | | | | | | | | | | | | | | | | | | | | | | | | | | | | | | | | | | | | | | | | | | | | | | | | | | | | | | | | | | | | | | | | | | | | | | | | | | | | | | | | | | | | | | | | | | | | | | | | | | | | | | | | | | | | | | | | | | | | | | | | | | | | | | | | | | | | | | | | | | | | | | | | | | | | | | | | | | | | | | | | | | | | | | | | | | | | | | | | | | | | | | | | | | | | | | | | | | | | | | | | | | | | | | | | | | | | | | | | | | | | | | | | | | | | | | | | | | | | | | | | | | | | | | | | | | | | | | | | | | | | | | | | | | | | | | | | | | | | | | | | | | | | | | | | | | | | | | | | | | | | | | | | | | | | | | | | | | | | | | | | | | | | | | | | | | | | | | | | | | | | | | | | | | | | | | | | | | | | | | | | | | | | | | | | | | | | | | | | | | | | | | | | | | | | | | | | | | | | | | | | | | | | | | | | | | | | | | | | | | | | | | | | | | | | | | | | | | | | | | | | | | | | | | | | | | | | | | | | | | | | | | | | | | | | | | | | | | | | | | | | | | | | | | | | | | | | | | | | | | | | | | | | | | | | | | | | | | | | | | | | | | | | | | | | | | | | | | | | | | | | | | | | | | | | | | | | | | | | | | | | | | | | | | | | | | | | | | | | | | | | | | | | | | | | | | | | | | | | | | | | | | | | | | | | | | | | | | | | | | | | | | | | | | | | | | | | | | | | | | | | | | | | | | | | | | | | | | | | | | | | | | | | | | | | | | | | | | | |
| 3Ø 60 Hz | | | | 115 Vac | 200 Vac [8] | 230 Vac | 120 Vdc | 240 Vdc | Ordinary Service [6] | | | | Heavy Service and Energy Efficient [7] | | THHN THWN XHHW | THW | | | | | | | | | | | | | | | | | | | | | | | | | | | | | | | | | | | | | | | | | | | | | | | | | | | | | | | | | | | | | | | | | | | | | | | | | | | | | | | | | | | | | | | | | | | | | | | | | | | | | | | | | | | | | | | | | | | | | | | | | | | | | | | | | | | | | | | | | | | | | | | | | | | | | | | | | | | | | | | | | | | | | | | | | | | | | | | | | | | | | | | | | | | | | | | | | | | | | | | | | | | | | | | | | | | | | | | | | | | | | | | | | | | | | | | | | | | | | | | | | | | | | | | | | | | | | | | | | | | | | | | | | | | | | | | | | | | | | | | | | | | | | | | | | | | | | | | | | | | | | | | | | | | | | | | | | | | | | | | | | | | | | | | | | | | | | | | | | | | | | | | | | | | | | | | | | | | | | | | | | | | | | | | | | | | | | | | | | | | | | | | | | | | | | | | | | | | | | | | | | | | | | | | | | | | | | | | | | | | | | | | | | | | | | | | | | | | | | | | | | | | | | | | | | | | | | | | | | | | | | | | | | | | | | | | | | | | | | | | | | | | | | | | | | | | | | | | | | | | | | | | | | | | | | | | | | | | | | | | | | | | | | | | | | | | | | | | | | | | | | | | | | | | | | | | | | | | | | | | | | | | | | | | | | | | | | | | | | | | | | | | | | | | | | | | | | | | | | | | | | | | | | | | | | | | | | | | | | | | | | | | | | | | | | | | | | | | | | | | | | | | | | | | | | | | | | | | | | | | | | | | | | | | | | | | | | | | | | | | | | | | | | | | | | | | | | | | | | | | | | | | | | | | | | | | | | | | | | | | | | | | | | | | | | | | | | | | | | | | | | | | | | | | | | | | | | | | | | | |
| | | | | | | 3/4 | | | | 6.9 A | 15 A | 20 A | 14 | 1/2 in. | N/A | | | | | | | | | | | | | | | | | | | | | | | | | | | | | | | | | | | | | | | | | | | | | | | | | | | | | | | | | | | | | | | | | | | | | | | | | | | | | | | | | | | | | | | | | | | | | | | | | | | | | | | | | | | | | | | | | | | | | | | | | | | | | | | | | | | | | | | | | | | | | | | | | | | | | | | | | | | | | | | | | | | | | | | | | | | | | | | | | | | | | | | | | | | | | | | | | | | | | | | | | | | | | | | | | | | | | | | | | | | | | | | | | | | | | | | | | | | | | | | | | | | | | | | | | | | | | | | | | | | | | | | | | | | | | | | | | | | | | | | | | | | | | | | | | | | | | | | | | | | | | | | | | | | | | | | | | | | | | | | | | | | | | | | | | | | | | | | | | | | | | | | | | | | | | | | | | | | | | | | | | | | | | | | | | | | | | | | | | | | | | | | | | | | | | | | | | | | | | | | | | | | | | | | | | | | | | | | | | | | | | | | | | | | | | | | | | | | | | | | | | | | | | | | | | | | | | | | | | | | | | | | | | | | | | | | | | | | | | | | | | | | | | | | | | | | | | | | | | | | | | | | | | | | | | | | | | | | | | | | | | | | | | | | | | | | | | | | | | | | | | | | | | | | | | | | | | | | | | | | | | | | | | | | | | | | | | | | | | | | | | | | | | | | | | | | | | | | | | | | | | | | | | | | | | | | | | | | | | | | | | | | | | | | | | | | | | | | | | | | | | | | | | | | | | | | | | | | | | | | | | | | | | | | | | | | | | | | | | | | | | | | | | | | | | | | | | | | | | | | | | | | | | | | | | | | | | | | | | | | | | | | | | | | | | | | | | | | | | | | | | | | | | | | | | | | | | | | | | | | |
| | | | | 1/3 | | | | | | 7.2 A | | | | | | | | 5 | | | | | 3.4 | | | 7.6 A | 2 | | | | | 3/4 | | | | | 7.8 A | | | | | | | 1 | | 2 | | 7.9 A | | | | | | | | | | | 8.0 A | | | | 7-1/2 | | | | | | | 8.5 A | | | | | | 1 | | | | | 9.0 A | | | | | | | | 1 | | | 9.2 A | | 3 | | | | | | | | | 9.5 A | | | | | 1/2 | | | | | | 9.6 A | | | | | | | 1-1/2 | | | | 9.8 A | | | | | | | | | | | 10.0 A | 3 | 7-1/2 | 10 | | | 1-1/2 | | | | | 11.0 A | | | | | | | 2 | | | | 11.5 A | | | | | | | | | 3 | | 12.0 A | | | | | 3/4 | 2 | | 1-1/2 | | | 12.2 A | | | | | | | | | | | 13.2 A | | 5 | | | | | | | | | 13.8 A | | | | | | | | | | | 14.0 A | | | | | | | | | | | 15.2 A | | | | 15 | | | 3 | 2 | | | 16.0 A | 5 | | | | | 1-1/2 | | | 5 | | 17.0 A | | | | | | | | | | | 17.5 A | | | | | | 3 | | | | | 19.6 A | | | | | | | | | | | 20.0 A | | 7-1/2 | | | | | | | | | 21.0 A | | | | | | | | | | | 22.0 A | | | | | 2 | | | | | | 24.0 A | | | | | | | | 3 | | | 25.0 A | 7-1/2 | | | | | | | | | | 25.3 A | | | | | | | | | | | 27.0 A | | 10 | | | | 5 | | | | | 28.0 A | | | | | | | | | 7-1/2 | | 29.0 A | | | | | | | | | | | 32.0 A | 10 | | | | | | | | | | 32.2 A | | | | | | | | | | | 34.0 A | | | | | | | | | | | 38.0 A | | | | | | | 7-1/2 | 5 | | | 40.0 A | | | | | | | | | | | 41.0 A | | 15 | | | | | | | | | 42.0 A | | | | | | | 7-1/2 | | | | 46.0 A | 15 | | | | | | | | | | 48.3 A | | | | | | | | | | | 50.0 A | | | | | | | | | | | 52.0 A | | | | | | | | | | | 54.0 A | | | | | | | | | 15 | | 55.0 A | | | | | | 5 | | | | | 56.0 A | | | | | | | 10 | | | | 57.5 A | | | | | | | | 7-1/2 | | | 58.0 A | | | | | | | | | | | 62.0 A | 20 | | | | | | | | | | 62.1 A | | | | | | | | | | | 65.0 A | | | | | | | | | | | 68.0 A | | | | | | | | | 20 | | 72.0 A | | | | | | | | | | | 76.0 A | | | | | | | | | | | 77.0 A | | | | | | | | | | | 78.2 A | 25 | | | | | | | | | | 80.0 A | | | | | | 7-1/2 | | | | | 89.0 A | | | | | | | | | 25 | | 125 A | | | | | | | | | | | 125 A | | | | | | | | | | | 150 A | | | | | | | | | | | 150 A | | | | | | | | | | | 175 A | | | | | | | | | | | 175 A | | | | | | | | | | | 200 A | | | | | | | | | | | 200 A | | | | | | | | | | | 225 A | | | | | | | | | | | 225 A | | | | | | | | | | | 250 A |
| | | 5 | | | | | 3.4 | | | 7.6 A | | | | | | 2 | | | | | 3/4 | | | | | 7.8 A | | | | | | | 1 | | 2 | | 7.9 A | | | | | | | | | | | 8.0 A | | | | 7-1/2 | | | | | | | 8.5 A | | | | | | 1 | | | | | 9.0 A | | | | | | | | 1 | | | 9.2 A | | 3 | | | | | | | | | 9.5 A | | | | | 1/2 | | | | | | 9.6 A | | | | | | | 1-1/2 | | | | 9.8 A | | | | | | | | | | | 10.0 A | 3 | 7-1/2 | 10 | | | 1-1/2 | | | | | 11.0 A | | | | | | | 2 | | | | 11.5 A | | | | | | | | | 3 | | 12.0 A | | | | | 3/4 | 2 | | 1-1/2 | | | 12.2 A | | | | | | | | | | | 13.2 A | | 5 | | | | | | | | | 13.8 A | | | | | | | | | | | 14.0 A | | | | | | | | | | | 15.2 A | | | | 15 | | | 3 | 2 | | | 16.0 A | 5 | | | | | 1-1/2 | | | 5 | | 17.0 A | | | | | | | | | | | 17.5 A | | | | | | 3 | | | | | 19.6 A | | | | | | | | | | | 20.0 A | | 7-1/2 | | | | | | | | | 21.0 A | | | | | | | | | | | 22.0 A | | | | | 2 | | | | | | 24.0 A | | | | | | | | 3 | | | 25.0 A | 7-1/2 | | | | | | | | | | 25.3 A | | | | | | | | | | | 27.0 A | | 10 | | | | 5 | | | | | 28.0 A | | | | | | | | | 7-1/2 | | 29.0 A | | | | | | | | | | | 32.0 A | 10 | | | | | | | | | | 32.2 A | | | | | | | | | | | 34.0 A | | | | | | | | | | | 38.0 A | | | | | | | 7-1/2 | 5 | | | 40.0 A | | | | | | | | | | | 41.0 A | | 15 | | | | | | | | | 42.0 A | | | | | | | 7-1/2 | | | | 46.0 A | 15 | | | | | | | | | | 48.3 A | | | | | | | | | | | 50.0 A | | | | | | | | | | | 52.0 A | | | | | | | | | | | 54.0 A | | | | | | | | | 15 | | 55.0 A | | | | | | 5 | | | | | 56.0 A | | | | | | | 10 | | | | 57.5 A | | | | | | | | 7-1/2 | | | 58.0 A | | | | | | | | | | | 62.0 A | 20 | | | | | | | | | | 62.1 A | | | | | | | | | | | 65.0 A | | | | | | | | | | | 68.0 A | | | | | | | | | 20 | | 72.0 A | | | | | | | | | | | 76.0 A | | | | | | | | | | | 77.0 A | | | | | | | | | | | 78.2 A | 25 | | | | | | | | | | 80.0 A | | | | | | 7-1/2 | | | | | 89.0 A | | | | | | | | | 25 | | 125 A | | | | | | | | | | | 125 A | | | | | | | | | | | 150 A | | | | | | | | | | | 150 A | | | | | | | | | | | 175 A | | | | | | | | | | | 175 A | | | | | | | | | | | 200 A | | | | | | | | | | | 200 A | | | | | | | | | | | 225 A | | | | | | | | | | | 225 A | | | | | | | | | | | 250 A | | | | | | | | | | | |
| 2 | | | | | 3/4 | | | | | 7.8 A | | | | | | | | | | | | 1 | | 2 | | 7.9 A | | | | | | | | | | | 8.0 A | | | | 7-1/2 | | | | | | | 8.5 A | | | | | | 1 | | | | | 9.0 A | | | | | | | | 1 | | | 9.2 A | | 3 | | | | | | | | | 9.5 A | | | | | 1/2 | | | | | | 9.6 A | | | | | | | 1-1/2 | | | | 9.8 A | | | | | | | | | | | 10.0 A | 3 | 7-1/2 | 10 | | | 1-1/2 | | | | | 11.0 A | | | | | | | 2 | | | | 11.5 A | | | | | | | | | 3 | | 12.0 A | | | | | 3/4 | 2 | | 1-1/2 | | | 12.2 A | | | | | | | | | | | 13.2 A | | 5 | | | | | | | | | 13.8 A | | | | | | | | | | | 14.0 A | | | | | | | | | | | 15.2 A | | | | 15 | | | 3 | 2 | | | 16.0 A | 5 | | | | | 1-1/2 | | | 5 | | 17.0 A | | | | | | | | | | | 17.5 A | | | | | | 3 | | | | | 19.6 A | | | | | | | | | | | 20.0 A | | 7-1/2 | | | | | | | | | 21.0 A | | | | | | | | | | | 22.0 A | | | | | 2 | | | | | | 24.0 A | | | | | | | | 3 | | | 25.0 A | 7-1/2 | | | | | | | | | | 25.3 A | | | | | | | | | | | 27.0 A | | 10 | | | | 5 | | | | | 28.0 A | | | | | | | | | 7-1/2 | | 29.0 A | | | | | | | | | | | 32.0 A | 10 | | | | | | | | | | 32.2 A | | | | | | | | | | | 34.0 A | | | | | | | | | | | 38.0 A | | | | | | | 7-1/2 | 5 | | | 40.0 A | | | | | | | | | | | 41.0 A | | 15 | | | | | | | | | 42.0 A | | | | | | | 7-1/2 | | | | 46.0 A | 15 | | | | | | | | | | 48.3 A | | | | | | | | | | | 50.0 A | | | | | | | | | | | 52.0 A | | | | | | | | | | | 54.0 A | | | | | | | | | 15 | | 55.0 A | | | | | | 5 | | | | | 56.0 A | | | | | | | 10 | | | | 57.5 A | | | | | | | | 7-1/2 | | | 58.0 A | | | | | | | | | | | 62.0 A | 20 | | | | | | | | | | 62.1 A | | | | | | | | | | | 65.0 A | | | | | | | | | | | 68.0 A | | | | | | | | | 20 | | 72.0 A | | | | | | | | | | | 76.0 A | | | | | | | | | | | 77.0 A | | | | | | | | | | | 78.2 A | 25 | | | | | | | | | | 80.0 A | | | | | | 7-1/2 | | | | | 89.0 A | | | | | | | | | 25 | | 125 A | | | | | | | | | | | 125 A | | | | | | | | | | | 150 A | | | | | | | | | | | 150 A | | | | | | | | | | | 175 A | | | | | | | | | | | 175 A | | | | | | | | | | | 200 A | | | | | | | | | | | 200 A | | | | | | | | | | | 225 A | | | | | | | | | | | 225 A | | | | | | | | | | | 250 A | | | | | | | | | | | | | | | | | | | | | | |
| | | | | | | 1 | | 2 | | 7.9 A | | | | | | | | | | | | | | | | 8.0 A | | | | 7-1/2 | | | | | | | 8.5 A | | | | | | 1 | | | | | 9.0 A | | | | | | | | 1 | | | 9.2 A | | 3 | | | | | | | | | 9.5 A | | | | | 1/2 | | | | | | 9.6 A | | | | | | | 1-1/2 | | | | 9.8 A | | | | | | | | | | | 10.0 A | 3 | 7-1/2 | 10 | | | 1-1/2 | | | | | 11.0 A | | | | | | | 2 | | | | 11.5 A | | | | | | | | | 3 | | 12.0 A | | | | | 3/4 | 2 | | 1-1/2 | | | 12.2 A | | | | | | | | | | | 13.2 A | | 5 | | | | | | | | | 13.8 A | | | | | | | | | | | 14.0 A | | | | | | | | | | | 15.2 A | | | | 15 | | | 3 | 2 | | | 16.0 A | 5 | | | | | 1-1/2 | | | 5 | | 17.0 A | | | | | | | | | | | 17.5 A | | | | | | 3 | | | | | 19.6 A | | | | | | | | | | | 20.0 A | | 7-1/2 | | | | | | | | | 21.0 A | | | | | | | | | | | 22.0 A | | | | | 2 | | | | | | 24.0 A | | | | | | | | 3 | | | 25.0 A | 7-1/2 | | | | | | | | | | 25.3 A | | | | | | | | | | | 27.0 A | | 10 | | | | 5 | | | | | 28.0 A | | | | | | | | | 7-1/2 | | 29.0 A | | | | | | | | | | | 32.0 A | 10 | | | | | | | | | | 32.2 A | | | | | | | | | | | 34.0 A | | | | | | | | | | | 38.0 A | | | | | | | 7-1/2 | 5 | | | 40.0 A | | | | | | | | | | | 41.0 A | | 15 | | | | | | | | | 42.0 A | | | | | | | 7-1/2 | | | | 46.0 A | 15 | | | | | | | | | | 48.3 A | | | | | | | | | | | 50.0 A | | | | | | | | | | | 52.0 A | | | | | | | | | | | 54.0 A | | | | | | | | | 15 | | 55.0 A | | | | | | 5 | | | | | 56.0 A | | | | | | | 10 | | | | 57.5 A | | | | | | | | 7-1/2 | | | 58.0 A | | | | | | | | | | | 62.0 A | 20 | | | | | | | | | | 62.1 A | | | | | | | | | | | 65.0 A | | | | | | | | | | | 68.0 A | | | | | | | | | 20 | | 72.0 A | | | | | | | | | | | 76.0 A | | | | | | | | | | | 77.0 A | | | | | | | | | | | 78.2 A | 25 | | | | | | | | | | 80.0 A | | | | | | 7-1/2 | | | | | 89.0 A | | | | | | | | | 25 | | 125 A | | | | | | | | | | | 125 A | | | | | | | | | | | 150 A | | | | | | | | | | | 150 A | | | | | | | | | | | 175 A | | | | | | | | | | | 175 A | | | | | | | | | | | 200 A | | | | | | | | | | | 200 A | | | | | | | | | | | 225 A | | | | | | | | | | | 225 A | | | | | | | | | | | 250 A | | | | | | | | | | | | | | | | | | | | | | | | | | | | | | | | | |
| | | | | | | | | | | 8.0 A | | | | | | | | | 7-1/2 | | | | | | | 8.5 A | | | | | | 1 | | | | | 9.0 A | | | | | | | | 1 | | | 9.2 A | | 3 | | | | | | | | | 9.5 A | | | | | 1/2 | | | | | | 9.6 A | | | | | | | 1-1/2 | | | | 9.8 A | | | | | | | | | | | 10.0 A | 3 | 7-1/2 | 10 | | | 1-1/2 | | | | | 11.0 A | | | | | | | 2 | | | | 11.5 A | | | | | | | | | 3 | | 12.0 A | | | | | 3/4 | 2 | | 1-1/2 | | | 12.2 A | | | | | | | | | | | 13.2 A | | 5 | | | | | | | | | 13.8 A | | | | | | | | | | | 14.0 A | | | | | | | | | | | 15.2 A | | | | 15 | | | 3 | 2 | | | 16.0 A | 5 | | | | | 1-1/2 | | | 5 | | 17.0 A | | | | | | | | | | | 17.5 A | | | | | | 3 | | | | | 19.6 A | | | | | | | | | | | 20.0 A | | 7-1/2 | | | | | | | | | 21.0 A | | | | | | | | | | | 22.0 A | | | | | 2 | | | | | | 24.0 A | | | | | | | | 3 | | | 25.0 A | 7-1/2 | | | | | | | | | | 25.3 A | | | | | | | | | | | 27.0 A | | 10 | | | | 5 | | | | | 28.0 A | | | | | | | | | 7-1/2 | | 29.0 A | | | | | | | | | | | 32.0 A | 10 | | | | | | | | | | 32.2 A | | | | | | | | | | | 34.0 A | | | | | | | | | | | 38.0 A | | | | | | | 7-1/2 | 5 | | | 40.0 A | | | | | | | | | | | 41.0 A | | 15 | | | | | | | | | 42.0 A | | | | | | | 7-1/2 | | | | 46.0 A | 15 | | | | | | | | | | 48.3 A | | | | | | | | | | | 50.0 A | | | | | | | | | | | 52.0 A | | | | | | | | | | | 54.0 A | | | | | | | | | 15 | | 55.0 A | | | | | | 5 | | | | | 56.0 A | | | | | | | 10 | | | | 57.5 A | | | | | | | | 7-1/2 | | | 58.0 A | | | | | | | | | | | 62.0 A | 20 | | | | | | | | | | 62.1 A | | | | | | | | | | | 65.0 A | | | | | | | | | | | 68.0 A | | | | | | | | | 20 | | 72.0 A | | | | | | | | | | | 76.0 A | | | | | | | | | | | 77.0 A | | | | | | | | | | | 78.2 A | 25 | | | | | | | | | | 80.0 A | | | | | | 7-1/2 | | | | | 89.0 A | | | | | | | | | 25 | | 125 A | | | | | | | | | | | 125 A | | | | | | | | | | | 150 A | | | | | | | | | | | 150 A | | | | | | | | | | | 175 A | | | | | | | | | | | 175 A | | | | | | | | | | | 200 A | | | | | | | | | | | 200 A | | | | | | | | | | | 225 A | | | | | | | | | | | 225 A | | | | | | | | | | | 250 A | | | | | | | | | | | | | | | | | | | | | | | | | | | | | | | | | | | | | | | | | | | | |
| | | | 7-1/2 | | | | | | | 8.5 A | | | | | | | | 1 | | | | | 9.0 A | | | | | | | | 1 | | | 9.2 A | | 3 | | | | | | | | | 9.5 A | | | | | 1/2 | | | | | | 9.6 A | | | | | | | 1-1/2 | | | | 9.8 A | | | | | | | | | | | 10.0 A | 3 | 7-1/2 | 10 | | | 1-1/2 | | | | | 11.0 A | | | | | | | 2 | | | | 11.5 A | | | | | | | | | 3 | | 12.0 A | | | | | 3/4 | 2 | | 1-1/2 | | | 12.2 A | | | | | | | | | | | 13.2 A | | 5 | | | | | | | | | 13.8 A | | | | | | | | | | | 14.0 A | | | | | | | | | | | 15.2 A | | | | 15 | | | 3 | 2 | | | 16.0 A | 5 | | | | | 1-1/2 | | | 5 | | 17.0 A | | | | | | | | | | | 17.5 A | | | | | | 3 | | | | | 19.6 A | | | | | | | | | | | 20.0 A | | 7-1/2 | | | | | | | | | 21.0 A | | | | | | | | | | | 22.0 A | | | | | 2 | | | | | | 24.0 A | | | | | | | | 3 | | | 25.0 A | 7-1/2 | | | | | | | | | | 25.3 A | | | | | | | | | | | 27.0 A | | 10 | | | | 5 | | | | | 28.0 A | | | | | | | | | 7-1/2 | | 29.0 A | | | | | | | | | | | 32.0 A | 10 | | | | | | | | | | 32.2 A | | | | | | | | | | | 34.0 A | | | | | | | | | | | 38.0 A | | | | | | | 7-1/2 | 5 | | | 40.0 A | | | | | | | | | | | 41.0 A | | 15 | | | | | | | | | 42.0 A | | | | | | | 7-1/2 | | | | 46.0 A | 15 | | | | | | | | | | 48.3 A | | | | | | | | | | | 50.0 A | | | | | | | | | | | 52.0 A | | | | | | | | | | | 54.0 A | | | | | | | | | 15 | | 55.0 A | | | | | | 5 | | | | | 56.0 A | | | | | | | 10 | | | | 57.5 A | | | | | | | | 7-1/2 | | | 58.0 A | | | | | | | | | | | 62.0 A | 20 | | | | | | | | | | 62.1 A | | | | | | | | | | | 65.0 A | | | | | | | | | | | 68.0 A | | | | | | | | | 20 | | 72.0 A | | | | | | | | | | | 76.0 A | | | | | | | | | | | 77.0 A | | | | | | | | | | | 78.2 A | 25 | | | | | | | | | | 80.0 A | | | | | | 7-1/2 | | | | | 89.0 A | | | | | | | | | 25 | | 125 A | | | | | | | | | | | 125 A | | | | | | | | | | | 150 A | | | | | | | | | | | 150 A | | | | | | | | | | | 175 A | | | | | | | | | | | 175 A | | | | | | | | | | | 200 A | | | | | | | | | | | 200 A | | | | | | | | | | | 225 A | | | | | | | | | | | 225 A | | | | | | | | | | | 250 A | | | | | | | | | | | | | | | | | | | | | | | | | | | | | | | | | | | | | | | | | | | | | | | | | | | | | | | | | | |
| | | | | | 1 | | | | | 9.0 A | | | | | | | | | | 1 | | | 9.2 A | | 3 | | | | | | | | | 9.5 A | | | | | 1/2 | | | | | | 9.6 A | | | | | | | 1-1/2 | | | | 9.8 A | | | | | | | | | | | 10.0 A | 3 | 7-1/2 | 10 | | | 1-1/2 | | | | | 11.0 A | | | | | | | 2 | | | | 11.5 A | | | | | | | | | 3 | | 12.0 A | | | | | 3/4 | 2 | | 1-1/2 | | | 12.2 A | | | | | | | | | | | 13.2 A | | 5 | | | | | | | | | 13.8 A | | | | | | | | | | | 14.0 A | | | | | | | | | | | 15.2 A | | | | 15 | | | 3 | 2 | | | 16.0 A | 5 | | | | | 1-1/2 | | | 5 | | 17.0 A | | | | | | | | | | | 17.5 A | | | | | | 3 | | | | | 19.6 A | | | | | | | | | | | 20.0 A | | 7-1/2 | | | | | | | | | 21.0 A | | | | | | | | | | | 22.0 A | | | | | 2 | | | | | | 24.0 A | | | | | | | | 3 | | | 25.0 A | 7-1/2 | | | | | | | | | | 25.3 A | | | | | | | | | | | 27.0 A | | 10 | | | | 5 | | | | | 28.0 A | | | | | | | | | 7-1/2 | | 29.0 A | | | | | | | | | | | 32.0 A | 10 | | | | | | | | | | 32.2 A | | | | | | | | | | | 34.0 A | | | | | | | | | | | 38.0 A | | | | | | | 7-1/2 | 5 | | | 40.0 A | | | | | | | | | | | 41.0 A | | 15 | | | | | | | | | 42.0 A | | | | | | | 7-1/2 | | | | 46.0 A | 15 | | | | | | | | | | 48.3 A | | | | | | | | | | | 50.0 A | | | | | | | | | | | 52.0 A | | | | | | | | | | | 54.0 A | | | | | | | | | 15 | | 55.0 A | | | | | | 5 | | | | | 56.0 A | | | | | | | 10 | | | | 57.5 A | | | | | | | | 7-1/2 | | | 58.0 A | | | | | | | | | | | 62.0 A | 20 | | | | | | | | | | 62.1 A | | | | | | | | | | | 65.0 A | | | | | | | | | | | 68.0 A | | | | | | | | | 20 | | 72.0 A | | | | | | | | | | | 76.0 A | | | | | | | | | | | 77.0 A | | | | | | | | | | | 78.2 A | 25 | | | | | | | | | | 80.0 A | | | | | | 7-1/2 | | | | | 89.0 A | | | | | | | | | 25 | | 125 A | | | | | | | | | | | 125 A | | | | | | | | | | | 150 A | | | | | | | | | | | 150 A | | | | | | | | | | | 175 A | | | | | | | | | | | 175 A | | | | | | | | | | | 200 A | | | | | | | | | | | 200 A | | | | | | | | | | | 225 A | | | | | | | | | | | 225 A | | | | | | | | | | | 250 A | | | | | | | | | | | | | | | | | | | | | | | | | | | | | | | | | | | | | | | | | | | | | | | | | | | | | | | | | | | | | | | | | | | | | |
| | | | | | | | 1 | | | 9.2 A | | | | 3 | | | | | | | | | 9.5 A | | | | | 1/2 | | | | | | 9.6 A | | | | | | | 1-1/2 | | | | 9.8 A | | | | | | | | | | | 10.0 A | 3 | 7-1/2 | 10 | | | 1-1/2 | | | | | 11.0 A | | | | | | | 2 | | | | 11.5 A | | | | | | | | | 3 | | 12.0 A | | | | | 3/4 | 2 | | 1-1/2 | | | 12.2 A | | | | | | | | | | | 13.2 A | | 5 | | | | | | | | | 13.8 A | | | | | | | | | | | 14.0 A | | | | | | | | | | | 15.2 A | | | | 15 | | | 3 | 2 | | | 16.0 A | 5 | | | | | 1-1/2 | | | 5 | | 17.0 A | | | | | | | | | | | 17.5 A | | | | | | 3 | | | | | 19.6 A | | | | | | | | | | | 20.0 A | | 7-1/2 | | | | | | | | | 21.0 A | | | | | | | | | | | 22.0 A | | | | | 2 | | | | | | 24.0 A | | | | | | | | 3 | | | 25.0 A | 7-1/2 | | | | | | | | | | 25.3 A | | | | | | | | | | | 27.0 A | | 10 | | | | 5 | | | | | 28.0 A | | | | | | | | | 7-1/2 | | 29.0 A | | | | | | | | | | | 32.0 A | 10 | | | | | | | | | | 32.2 A | | | | | | | | | | | 34.0 A | | | | | | | | | | | 38.0 A | | | | | | | 7-1/2 | 5 | | | 40.0 A | | | | | | | | | | | 41.0 A | | 15 | | | | | | | | | 42.0 A | | | | | | | 7-1/2 | | | | 46.0 A | 15 | | | | | | | | | | 48.3 A | | | | | | | | | | | 50.0 A | | | | | | | | | | | 52.0 A | | | | | | | | | | | 54.0 A | | | | | | | | | 15 | | 55.0 A | | | | | | 5 | | | | | 56.0 A | | | | | | | 10 | | | | 57.5 A | | | | | | | | 7-1/2 | | | 58.0 A | | | | | | | | | | | 62.0 A | 20 | | | | | | | | | | 62.1 A | | | | | | | | | | | 65.0 A | | | | | | | | | | | 68.0 A | | | | | | | | | 20 | | 72.0 A | | | | | | | | | | | 76.0 A | | | | | | | | | | | 77.0 A | | | | | | | | | | | 78.2 A | 25 | | | | | | | | | | 80.0 A | | | | | | 7-1/2 | | | | | 89.0 A | | | | | | | | | 25 | | 125 A | | | | | | | | | | | 125 A | | | | | | | | | | | 150 A | | | | | | | | | | | 150 A | | | | | | | | | | | 175 A | | | | | | | | | | | 175 A | | | | | | | | | | | 200 A | | | | | | | | | | | 200 A | | | | | | | | | | | 225 A | | | | | | | | | | | 225 A | | | | | | | | | | | 250 A | | | | | | | | | | | | | | | | | | | | | | | | | | | | | | | | | | | | | | | | | | | | | | | | | | | | | | | | | | | | | | | | | | | | | | | | | | | | | | | | |
| | 3 | | | | | | | | | 9.5 A | | | | | | | 1/2 | | | | | | 9.6 A | | | | | | | 1-1/2 | | | | 9.8 A | | | | | | | | | | | 10.0 A | 3 | 7-1/2 | 10 | | | 1-1/2 | | | | | 11.0 A | | | | | | | 2 | | | | 11.5 A | | | | | | | | | 3 | | 12.0 A | | | | | 3/4 | 2 | | 1-1/2 | | | 12.2 A | | | | | | | | | | | 13.2 A | | 5 | | | | | | | | | 13.8 A | | | | | | | | | | | 14.0 A | | | | | | | | | | | 15.2 A | | | | 15 | | | 3 | 2 | | | 16.0 A | 5 | | | | | 1-1/2 | | | 5 | | 17.0 A | | | | | | | | | | | 17.5 A | | | | | | 3 | | | | | 19.6 A | | | | | | | | | | | 20.0 A | | 7-1/2 | | | | | | | | | 21.0 A | | | | | | | | | | | 22.0 A | | | | | 2 | | | | | | 24.0 A | | | | | | | | 3 | | | 25.0 A | 7-1/2 | | | | | | | | | | 25.3 A | | | | | | | | | | | 27.0 A | | 10 | | | | 5 | | | | | 28.0 A | | | | | | | | | 7-1/2 | | 29.0 A | | | | | | | | | | | 32.0 A | 10 | | | | | | | | | | 32.2 A | | | | | | | | | | | 34.0 A | | | | | | | | | | | 38.0 A | | | | | | | 7-1/2 | 5 | | | 40.0 A | | | | | | | | | | | 41.0 A | | 15 | | | | | | | | | 42.0 A | | | | | | | 7-1/2 | | | | 46.0 A | 15 | | | | | | | | | | 48.3 A | | | | | | | | | | | 50.0 A | | | | | | | | | | | 52.0 A | | | | | | | | | | | 54.0 A | | | | | | | | | 15 | | 55.0 A | | | | | | 5 | | | | | 56.0 A | | | | | | | 10 | | | | 57.5 A | | | | | | | | 7-1/2 | | | 58.0 A | | | | | | | | | | | 62.0 A | 20 | | | | | | | | | | 62.1 A | | | | | | | | | | | 65.0 A | | | | | | | | | | | 68.0 A | | | | | | | | | 20 | | 72.0 A | | | | | | | | | | | 76.0 A | | | | | | | | | | | 77.0 A | | | | | | | | | | | 78.2 A | 25 | | | | | | | | | | 80.0 A | | | | | | 7-1/2 | | | | | 89.0 A | | | | | | | | | 25 | | 125 A | | | | | | | | | | | 125 A | | | | | | | | | | | 150 A | | | | | | | | | | | 150 A | | | | | | | | | | | 175 A | | | | | | | | | | | 175 A | | | | | | | | | | | 200 A | | | | | | | | | | | 200 A | | | | | | | | | | | 225 A | | | | | | | | | | | 225 A | | | | | | | | | | | 250 A | | | | | | | | | | | | | | | | | | | | | | | | | | | | | | | | | | | | | | | | | | | | | | | | | | | | | | | | | | | | | | | | | | | | | | | | | | | | | | | | | | | | | | | | | | | |
| | | | | 1/2 | | | | | | 9.6 A | | | | | | | | | 1-1/2 | | | | 9.8 A | | | | | | | | | | | 10.0 A | 3 | 7-1/2 | 10 | | | 1-1/2 | | | | | 11.0 A | | | | | | | 2 | | | | 11.5 A | | | | | | | | | 3 | | 12.0 A | | | | | 3/4 | 2 | | 1-1/2 | | | 12.2 A | | | | | | | | | | | 13.2 A | | 5 | | | | | | | | | 13.8 A | | | | | | | | | | | 14.0 A | | | | | | | | | | | 15.2 A | | | | 15 | | | 3 | 2 | | | 16.0 A | 5 | | | | | 1-1/2 | | | 5 | | 17.0 A | | | | | | | | | | | 17.5 A | | | | | | 3 | | | | | 19.6 A | | | | | | | | | | | 20.0 A | | 7-1/2 | | | | | | | | | 21.0 A | | | | | | | | | | | 22.0 A | | | | | 2 | | | | | | 24.0 A | | | | | | | | 3 | | | 25.0 A | 7-1/2 | | | | | | | | | | 25.3 A | | | | | | | | | | | 27.0 A | | 10 | | | | 5 | | | | | 28.0 A | | | | | | | | | 7-1/2 | | 29.0 A | | | | | | | | | | | 32.0 A | 10 | | | | | | | | | | 32.2 A | | | | | | | | | | | 34.0 A | | | | | | | | | | | 38.0 A | | | | | | | 7-1/2 | 5 | | | 40.0 A | | | | | | | | | | | 41.0 A | | 15 | | | | | | | | | 42.0 A | | | | | | | 7-1/2 | | | | 46.0 A | 15 | | | | | | | | | | 48.3 A | | | | | | | | | | | 50.0 A | | | | | | | | | | | 52.0 A | | | | | | | | | | | 54.0 A | | | | | | | | | 15 | | 55.0 A | | | | | | 5 | | | | | 56.0 A | | | | | | | 10 | | | | 57.5 A | | | | | | | | 7-1/2 | | | 58.0 A | | | | | | | | | | | 62.0 A | 20 | | | | | | | | | | 62.1 A | | | | | | | | | | | 65.0 A | | | | | | | | | | | 68.0 A | | | | | | | | | 20 | | 72.0 A | | | | | | | | | | | 76.0 A | | | | | | | | | | | 77.0 A | | | | | | | | | | | 78.2 A | 25 | | | | | | | | | | 80.0 A | | | | | | 7-1/2 | | | | | 89.0 A | | | | | | | | | 25 | | 125 A | | | | | | | | | | | 125 A | | | | | | | | | | | 150 A | | | | | | | | | | | 150 A | | | | | | | | | | | 175 A | | | | | | | | | | | 175 A | | | | | | | | | | | 200 A | | | | | | | | | | | 200 A | | | | | | | | | | | 225 A | | | | | | | | | | | 225 A | | | | | | | | | | | 250 A | | | | | | | | | | | | | | | | | | | | | | | | | | | | | | | | | | | | | | | | | | | | | | | | | | | | | | | | | | | | | | | | | | | | | | | | | | | | | | | | | | | | | | | | | | | | | | | | | | | | | | |
| | | | | | | 1-1/2 | | | | 9.8 A | | | | | | | | | | | | | 10.0 A | 3 | 7-1/2 | 10 | | | 1-1/2 | | | | | 11.0 A | | | | | | | 2 | | | | 11.5 A | | | | | | | | | 3 | | 12.0 A | | | | | 3/4 | 2 | | 1-1/2 | | | 12.2 A | | | | | | | | | | | 13.2 A | | 5 | | | | | | | | | 13.8 A | | | | | | | | | | | 14.0 A | | | | | | | | | | | 15.2 A | | | | 15 | | | 3 | 2 | | | 16.0 A | 5 | | | | | 1-1/2 | | | 5 | | 17.0 A | | | | | | | | | | | 17.5 A | | | | | | 3 | | | | | 19.6 A | | | | | | | | | | | 20.0 A | | 7-1/2 | | | | | | | | | 21.0 A | | | | | | | | | | | 22.0 A | | | | | 2 | | | | | | 24.0 A | | | | | | | | 3 | | | 25.0 A | 7-1/2 | | | | | | | | | | 25.3 A | | | | | | | | | | | 27.0 A | | 10 | | | | 5 | | | | | 28.0 A | | | | | | | | | 7-1/2 | | 29.0 A | | | | | | | | | | | 32.0 A | 10 | | | | | | | | | | 32.2 A | | | | | | | | | | | 34.0 A | | | | | | | | | | | 38.0 A | | | | | | | 7-1/2 | 5 | | | 40.0 A | | | | | | | | | | | 41.0 A | | 15 | | | | | | | | | 42.0 A | | | | | | | 7-1/2 | | | | 46.0 A | 15 | | | | | | | | | | 48.3 A | | | | | | | | | | | 50.0 A | | | | | | | | | | | 52.0 A | | | | | | | | | | | 54.0 A | | | | | | | | | 15 | | 55.0 A | | | | | | 5 | | | | | 56.0 A | | | | | | | 10 | | | | 57.5 A | | | | | | | | 7-1/2 | | | 58.0 A | | | | | | | | | | | 62.0 A | 20 | | | | | | | | | | 62.1 A | | | | | | | | | | | 65.0 A | | | | | | | | | | | 68.0 A | | | | | | | | | 20 | | 72.0 A | | | | | | | | | | | 76.0 A | | | | | | | | | | | 77.0 A | | | | | | | | | | | 78.2 A | 25 | | | | | | | | | | 80.0 A | | | | | | 7-1/2 | | | | | 89.0 A | | | | | | | | | 25 | | 125 A | | | | | | | | | | | 125 A | | | | | | | | | | | 150 A | | | | | | | | | | | 150 A | | | | | | | | | | | 175 A | | | | | | | | | | | 175 A | | | | | | | | | | | 200 A | | | | | | | | | | | 200 A | | | | | | | | | | | 225 A | | | | | | | | | | | 225 A | | | | | | | | | | | 250 A | | | | | | | | | | | | | | | | | | | | | | | | | | | | | | | | | | | | | | | | | | | | | | | | | | | | | | | | | | | | | | | | | | | | | | | | | | | | | | | | | | | | | | | | | | | | | | | | | | | | | | | | | | | | | | | | | |
| | | | | | | | | | | 10.0 A | 3 | 7-1/2 | 10 | | | 1-1/2 | | | | | 11.0 A | | | | | | | 2 | | | | 11.5 A | | | | | | | | | 3 | | 12.0 A | | | | | 3/4 | 2 | | 1-1/2 | | | 12.2 A | | | | | | | | | | | 13.2 A | | 5 | | | | | | | | | 13.8 A | | | | | | | | | | | 14.0 A | | | | | | | | | | | 15.2 A | | | | 15 | | | 3 | 2 | | | 16.0 A | 5 | | | | | 1-1/2 | | | 5 | | 17.0 A | | | | | | | | | | | 17.5 A | | | | | | 3 | | | | | 19.6 A | | | | | | | | | | | 20.0 A | | 7-1/2 | | | | | | | | | 21.0 A | | | | | | | | | | | 22.0 A | | | | | 2 | | | | | | 24.0 A | | | | | | | | 3 | | | 25.0 A | 7-1/2 | | | | | | | | | | 25.3 A | | | | | | | | | | | 27.0 A | | 10 | | | | 5 | | | | | 28.0 A | | | | | | | | | 7-1/2 | | 29.0 A | | | | | | | | | | | 32.0 A | 10 | | | | | | | | | | 32.2 A | | | | | | | | | | | 34.0 A | | | | | | | | | | | 38.0 A | | | | | | | 7-1/2 | 5 | | | 40.0 A | | | | | | | | | | | 41.0 A | | 15 | | | | | | | | | 42.0 A | | | | | | | 7-1/2 | | | | 46.0 A | 15 | | | | | | | | | | 48.3 A | | | | | | | | | | | 50.0 A | | | | | | | | | | | 52.0 A | | | | | | | | | | | 54.0 A | | | | | | | | | 15 | | 55.0 A | | | | | | 5 | | | | | 56.0 A | | | | | | | 10 | | | | 57.5 A | | | | | | | | 7-1/2 | | | 58.0 A | | | | | | | | | | | 62.0 A | 20 | | | | | | | | | | 62.1 A | | | | | | | | | | | 65.0 A | | | | | | | | | | | 68.0 A | | | | | | | | | 20 | | 72.0 A | | | | | | | | | | | 76.0 A | | | | | | | | | | | 77.0 A | | | | | | | | | | | 78.2 A | 25 | | | | | | | | | | 80.0 A | | | | | | 7-1/2 | | | | | 89.0 A | | | | | | | | | 25 | | 125 A | | | | | | | | | | | 125 A | | | | | | | | | | | 150 A | | | | | | | | | | | 150 A | | | | | | | | | | | 175 A | | | | | | | | | | | 175 A | | | | | | | | | | | 200 A | | | | | | | | | | | 200 A | | | | | | | | | | | 225 A | | | | | | | | | | | 225 A | | | | | | | | | | | 250 A | | | | | | | | | | | | | | | | | | | | | | | | | | | | | | | | | | | | | | | | | | | | | | | | | | | | | | | | | | | | | | | | | | | | | | | | | | | | | | | | | | | | | | | | | | | | | | | | | | | | | | | | | | | | | | | | | | | | | | | | | | | | | | |
| 3 | 7-1/2 | 10 | | | 1-1/2 | | | | | 11.0 A | | | | | | | 2 | | | | 11.5 A | | | | | | | | | 3 | | 12.0 A | | | | | 3/4 | 2 | | 1-1/2 | | | 12.2 A | | | | | | | | | | | 13.2 A | | 5 | | | | | | | | | 13.8 A | | | | | | | | | | | 14.0 A | | | | | | | | | | | 15.2 A | | | | 15 | | | 3 | 2 | | | 16.0 A | 5 | | | | | 1-1/2 | | | 5 | | 17.0 A | | | | | | | | | | | 17.5 A | | | | | | 3 | | | | | 19.6 A | | | | | | | | | | | 20.0 A | | 7-1/2 | | | | | | | | | 21.0 A | | | | | | | | | | | 22.0 A | | | | | 2 | | | | | | 24.0 A | | | | | | | | 3 | | | 25.0 A | 7-1/2 | | | | | | | | | | 25.3 A | | | | | | | | | | | 27.0 A | | 10 | | | | 5 | | | | | 28.0 A | | | | | | | | | 7-1/2 | | 29.0 A | | | | | | | | | | | 32.0 A | 10 | | | | | | | | | | 32.2 A | | | | | | | | | | | 34.0 A | | | | | | | | | | | 38.0 A | | | | | | | 7-1/2 | 5 | | | 40.0 A | | | | | | | | | | | 41.0 A | | 15 | | | | | | | | | 42.0 A | | | | | | | 7-1/2 | | | | 46.0 A | 15 | | | | | | | | | | 48.3 A | | | | | | | | | | | 50.0 A | | | | | | | | | | | 52.0 A | | | | | | | | | | | 54.0 A | | | | | | | | | 15 | | 55.0 A | | | | | | 5 | | | | | 56.0 A | | | | | | | 10 | | | | 57.5 A | | | | | | | | 7-1/2 | | | 58.0 A | | | | | | | | | | | 62.0 A | 20 | | | | | | | | | | 62.1 A | | | | | | | | | | | 65.0 A | | | | | | | | | | | 68.0 A | | | | | | | | | 20 | | 72.0 A | | | | | | | | | | | 76.0 A | | | | | | | | | | | 77.0 A | | | | | | | | | | | 78.2 A | 25 | | | | | | | | | | 80.0 A | | | | | | 7-1/2 | | | | | 89.0 A | | | | | | | | | 25 | | 125 A | | | | | | | | | | | 125 A | | | | | | | | | | | 150 A | | | | | | | | | | | 150 A | | | | | | | | | | | 175 A | | | | | | | | | | | 175 A | | | | | | | | | | | 200 A | | | | | | | | | | | 200 A | | | | | | | | | | | 225 A | | | | | | | | | | | 225 A | | | | | | | | | | | 250 A | | | | | | | | | | | | | | | | | | | | | | | | | | | | | | | | | | | | | | | | | | | | | | | | | | | | | | | | | | | | | | | | | | | | | | | | | | | | | | | | | | | | | | | | | | | | | | | | | | | | | | | | | | | | | | | | | | | | | | | | | | | | | | | | | | | | | | | | | |
| | | | | | | 2 | | | | 11.5 A | | | | | | | | | 3 | | 12.0 A | | | | | 3/4 | 2 | | 1-1/2 | | | 12.2 A | | | | | | | | | | | 13.2 A | | 5 | | | | | | | | | 13.8 A | | | | | | | | | | | 14.0 A | | | | | | | | | | | 15.2 A | | | | 15 | | | 3 | 2 | | | 16.0 A | 5 | | | | | 1-1/2 | | | 5 | | 17.0 A | | | | | | | | | | | 17.5 A | | | | | | 3 | | | | | 19.6 A | | | | | | | | | | | 20.0 A | | 7-1/2 | | | | | | | | | 21.0 A | | | | | | | | | | | 22.0 A | | | | | 2 | | | | | | 24.0 A | | | | | | | | 3 | | | 25.0 A | 7-1/2 | | | | | | | | | | 25.3 A | | | | | | | | | | | 27.0 A | | 10 | | | | 5 | | | | | 28.0 A | | | | | | | | | 7-1/2 | | 29.0 A | | | | | | | | | | | 32.0 A | 10 | | | | | | | | | | 32.2 A | | | | | | | | | | | 34.0 A | | | | | | | | | | | 38.0 A | | | | | | | 7-1/2 | 5 | | | 40.0 A | | | | | | | | | | | 41.0 A | | 15 | | | | | | | | | 42.0 A | | | | | | | 7-1/2 | | | | 46.0 A | 15 | | | | | | | | | | 48.3 A | | | | | | | | | | | 50.0 A | | | | | | | | | | | 52.0 A | | | | | | | | | | | 54.0 A | | | | | | | | | 15 | | 55.0 A | | | | | | 5 | | | | | 56.0 A | | | | | | | 10 | | | | 57.5 A | | | | | | | | 7-1/2 | | | 58.0 A | | | | | | | | | | | 62.0 A | 20 | | | | | | | | | | 62.1 A | | | | | | | | | | | 65.0 A | | | | | | | | | | | 68.0 A | | | | | | | | | 20 | | 72.0 A | | | | | | | | | | | 76.0 A | | | | | | | | | | | 77.0 A | | | | | | | | | | | 78.2 A | 25 | | | | | | | | | | 80.0 A | | | | | | 7-1/2 | | | | | 89.0 A | | | | | | | | | 25 | | 125 A | | | | | | | | | | | 125 A | | | | | | | | | | | 150 A | | | | | | | | | | | 150 A | | | | | | | | | | | 175 A | | | | | | | | | | | 175 A | | | | | | | | | | | 200 A | | | | | | | | | | | 200 A | | | | | | | | | | | 225 A | | | | | | | | | | | 225 A | | | | | | | | | | | 250 A | | | | | | | | | | | | | | | | | | | | | | | | | | | | | | | | | | | | | | | | | | | | | | | | | | | | | | | | | | | | | | | | | | | | | | | | | | | | | | | | | | | | | | | | | | | | | | | | | | | | | | | | | | | | | | | | | | | | | | | | | | | | | | | | | | | | | | | | | | | | | | | | | | | | |
| | | | | | | | | 3 | | 12.0 A | | | | | 3/4 | 2 | | 1-1/2 | | | 12.2 A | | | | | | | | | | | 13.2 A | | 5 | | | | | | | | | 13.8 A | | | | | | | | | | | 14.0 A | | | | | | | | | | | 15.2 A | | | | 15 | | | 3 | 2 | | | 16.0 A | 5 | | | | | 1-1/2 | | | 5 | | 17.0 A | | | | | | | | | | | 17.5 A | | | | | | 3 | | | | | 19.6 A | | | | | | | | | | | 20.0 A | | 7-1/2 | | | | | | | | | 21.0 A | | | | | | | | | | | 22.0 A | | | | | 2 | | | | | | 24.0 A | | | | | | | | 3 | | | 25.0 A | 7-1/2 | | | | | | | | | | 25.3 A | | | | | | | | | | | 27.0 A | | 10 | | | | 5 | | | | | 28.0 A | | | | | | | | | 7-1/2 | | 29.0 A | | | | | | | | | | | 32.0 A | 10 | | | | | | | | | | 32.2 A | | | | | | | | | | | 34.0 A | | | | | | | | | | | 38.0 A | | | | | | | 7-1/2 | 5 | | | 40.0 A | | | | | | | | | | | 41.0 A | | 15 | | | | | | | | | 42.0 A | | | | | | | 7-1/2 | | | | 46.0 A | 15 | | | | | | | | | | 48.3 A | | | | | | | | | | | 50.0 A | | | | | | | | | | | 52.0 A | | | | | | | | | | | 54.0 A | | | | | | | | | 15 | | 55.0 A | | | | | | 5 | | | | | 56.0 A | | | | | | | 10 | | | | 57.5 A | | | | | | | | 7-1/2 | | | 58.0 A | | | | | | | | | | | 62.0 A | 20 | | | | | | | | | | 62.1 A | | | | | | | | | | | 65.0 A | | | | | | | | | | | 68.0 A | | | | | | | | | 20 | | 72.0 A | | | | | | | | | | | 76.0 A | | | | | | | | | | | 77.0 A | | | | | | | | | | | 78.2 A | 25 | | | | | | | | | | 80.0 A | | | | | | 7-1/2 | | | | | 89.0 A | | | | | | | | | 25 | | 125 A | | | | | | | | | | | 125 A | | | | | | | | | | | 150 A | | | | | | | | | | | 150 A | | | | | | | | | | | 175 A | | | | | | | | | | | 175 A | | | | | | | | | | | 200 A | | | | | | | | | | | 200 A | | | | | | | | | | | 225 A | | | | | | | | | | | 225 A | | | | | | | | | | | 250 A | | | | | | | | | | | | | | | | | | | | | | | | | | | | | | | | | | | | | | | | | | | | | | | | | | | | | | | | | | | | | | | | | | | | | | | | | | | | | | | | | | | | | | | | | | | | | | | | | | | | | | | | | | | | | | | | | | | | | | | | | | | | | | | | | | | | | | | | | | | | | | | | | | | | | | | | | | | | | | | |
| | | | | 3/4 | 2 | | 1-1/2 | | | 12.2 A | | | | | | | | | | | 13.2 A | | 5 | | | | | | | | | 13.8 A | | | | | | | | | | | 14.0 A | | | | | | | | | | | 15.2 A | | | | 15 | | | 3 | 2 | | | 16.0 A | 5 | | | | | 1-1/2 | | | 5 | | 17.0 A | | | | | | | | | | | 17.5 A | | | | | | 3 | | | | | 19.6 A | | | | | | | | | | | 20.0 A | | 7-1/2 | | | | | | | | | 21.0 A | | | | | | | | | | | 22.0 A | | | | | 2 | | | | | | 24.0 A | | | | | | | | 3 | | | 25.0 A | 7-1/2 | | | | | | | | | | 25.3 A | | | | | | | | | | | 27.0 A | | 10 | | | | 5 | | | | | 28.0 A | | | | | | | | | 7-1/2 | | 29.0 A | | | | | | | | | | | 32.0 A | 10 | | | | | | | | | | 32.2 A | | | | | | | | | | | 34.0 A | | | | | | | | | | | 38.0 A | | | | | | | 7-1/2 | 5 | | | 40.0 A | | | | | | | | | | | 41.0 A | | 15 | | | | | | | | | 42.0 A | | | | | | | 7-1/2 | | | | 46.0 A | 15 | | | | | | | | | | 48.3 A | | | | | | | | | | | 50.0 A | | | | | | | | | | | 52.0 A | | | | | | | | | | | 54.0 A | | | | | | | | | 15 | | 55.0 A | | | | | | 5 | | | | | 56.0 A | | | | | | | 10 | | | | 57.5 A | | | | | | | | 7-1/2 | | | 58.0 A | | | | | | | | | | | 62.0 A | 20 | | | | | | | | | | 62.1 A | | | | | | | | | | | 65.0 A | | | | | | | | | | | 68.0 A | | | | | | | | | 20 | | 72.0 A | | | | | | | | | | | 76.0 A | | | | | | | | | | | 77.0 A | | | | | | | | | | | 78.2 A | 25 | | | | | | | | | | 80.0 A | | | | | | 7-1/2 | | | | | 89.0 A | | | | | | | | | 25 | | 125 A | | | | | | | | | | | 125 A | | | | | | | | | | | 150 A | | | | | | | | | | | 150 A | | | | | | | | | | | 175 A | | | | | | | | | | | 175 A | | | | | | | | | | | 200 A | | | | | | | | | | | 200 A | | | | | | | | | | | 225 A | | | | | | | | | | | 225 A | | | | | | | | | | | 250 A | | | | | | | | | | | | | | | | | | | | | | | | | | | | | | | | | | | | | | | | | | | | | | | | | | | | | | | | | | | | | | | | | | | | | | | | | | | | | | | | | | | | | | | | | | | | | | | | | | | | | | | | | | | | | | | | | | | | | | | | | | | | | | | | | | | | | | | | | | | | | | | | | | | | | | | | | | | | | | | | | | | | | | | | | | |
| | | | | | | | | | | 13.2 A | | 5 | | | | | | | | | 13.8 A | | | | | | | | | | | 14.0 A | | | | | | | | | | | 15.2 A | | | | 15 | | | 3 | 2 | | | 16.0 A | 5 | | | | | 1-1/2 | | | 5 | | 17.0 A | | | | | | | | | | | 17.5 A | | | | | | 3 | | | | | 19.6 A | | | | | | | | | | | 20.0 A | | 7-1/2 | | | | | | | | | 21.0 A | | | | | | | | | | | 22.0 A | | | | | 2 | | | | | | 24.0 A | | | | | | | | 3 | | | 25.0 A | 7-1/2 | | | | | | | | | | 25.3 A | | | | | | | | | | | 27.0 A | | 10 | | | | 5 | | | | | 28.0 A | | | | | | | | | 7-1/2 | | 29.0 A | | | | | | | | | | | 32.0 A | 10 | | | | | | | | | | 32.2 A | | | | | | | | | | | 34.0 A | | | | | | | | | | | 38.0 A | | | | | | | 7-1/2 | 5 | | | 40.0 A | | | | | | | | | | | 41.0 A | | 15 | | | | | | | | | 42.0 A | | | | | | | 7-1/2 | | | | 46.0 A | 15 | | | | | | | | | | 48.3 A | | | | | | | | | | | 50.0 A | | | | | | | | | | | 52.0 A | | | | | | | | | | | 54.0 A | | | | | | | | | 15 | | 55.0 A | | | | | | 5 | | | | | 56.0 A | | | | | | | 10 | | | | 57.5 A | | | | | | | | 7-1/2 | | | 58.0 A | | | | | | | | | | | 62.0 A | 20 | | | | | | | | | | 62.1 A | | | | | | | | | | | 65.0 A | | | | | | | | | | | 68.0 A | | | | | | | | | 20 | | 72.0 A | | | | | | | | | | | 76.0 A | | | | | | | | | | | 77.0 A | | | | | | | | | | | 78.2 A | 25 | | | | | | | | | | 80.0 A | | | | | | 7-1/2 | | | | | 89.0 A | | | | | | | | | 25 | | 125 A | | | | | | | | | | | 125 A | | | | | | | | | | | 150 A | | | | | | | | | | | 150 A | | | | | | | | | | | 175 A | | | | | | | | | | | 175 A | | | | | | | | | | | 200 A | | | | | | | | | | | 200 A | | | | | | | | | | | 225 A | | | | | | | | | | | 225 A | | | | | | | | | | | 250 A | | | | | | | | | | | | | | | | | | | | | | | | | | | | | | | | | | | | | | | | | | | | | | | | | | | | | | | | | | | | | | | | | | | | | | | | | | | | | | | | | | | | | | | | | | | | | | | | | | | | | | | | | | | | | | | | | | | | | | | | | | | | | | | | | | | | | | | | | | | | | | | | | | | | | | | | | | | | | | | | | | | | | | | | | | | | | | | | | | | | | |
| | 5 | | | | | | | | | 13.8 A | | | | | | | | | | | 14.0 A | | | | | | | | | | | 15.2 A | | | | 15 | | | 3 | 2 | | | 16.0 A | 5 | | | | | 1-1/2 | | | 5 | | 17.0 A | | | | | | | | | | | 17.5 A | | | | | | 3 | | | | | 19.6 A | | | | | | | | | | | 20.0 A | | 7-1/2 | | | | | | | | | 21.0 A | | | | | | | | | | | 22.0 A | | | | | 2 | | | | | | 24.0 A | | | | | | | | 3 | | | 25.0 A | 7-1/2 | | | | | | | | | | 25.3 A | | | | | | | | | | | 27.0 A | | 10 | | | | 5 | | | | | 28.0 A | | | | | | | | | 7-1/2 | | 29.0 A | | | | | | | | | | | 32.0 A | 10 | | | | | | | | | | 32.2 A | | | | | | | | | | | 34.0 A | | | | | | | | | | | 38.0 A | | | | | | | 7-1/2 | 5 | | | 40.0 A | | | | | | | | | | | 41.0 A | | 15 | | | | | | | | | 42.0 A | | | | | | | 7-1/2 | | | | 46.0 A | 15 | | | | | | | | | | 48.3 A | | | | | | | | | | | 50.0 A | | | | | | | | | | | 52.0 A | | | | | | | | | | | 54.0 A | | | | | | | | | 15 | | 55.0 A | | | | | | 5 | | | | | 56.0 A | | | | | | | 10 | | | | 57.5 A | | | | | | | | 7-1/2 | | | 58.0 A | | | | | | | | | | | 62.0 A | 20 | | | | | | | | | | 62.1 A | | | | | | | | | | | 65.0 A | | | | | | | | | | | 68.0 A | | | | | | | | | 20 | | 72.0 A | | | | | | | | | | | 76.0 A | | | | | | | | | | | 77.0 A | | | | | | | | | | | 78.2 A | 25 | | | | | | | | | | 80.0 A | | | | | | 7-1/2 | | | | | 89.0 A | | | | | | | | | 25 | | 125 A | | | | | | | | | | | 125 A | | | | | | | | | | | 150 A | | | | | | | | | | | 150 A | | | | | | | | | | | 175 A | | | | | | | | | | | 175 A | | | | | | | | | | | 200 A | | | | | | | | | | | 200 A | | | | | | | | | | | 225 A | | | | | | | | | | | 225 A | | | | | | | | | | | 250 A | | | | | | | | | | | | | | | | | | | | | | | | | | | | | | | | | | | | | | | | | | | | | | | | | | | | | | | | | | | | | | | | | | | | | | | | | | | | | | | | | | | | | | | | | | | | | | | | | | | | | | | | | | | | | | | | | | | | | | | | | | | | | | | | | | | | | | | | | | | | | | | | | | | | | | | | | | | | | | | | | | | | | | | | | | | | | | | | | | | | | | | | | | | | | | | | |
| | | | | | | | | | | 14.0 A | | | | | | | | | | | 15.2 A | | | | 15 | | | 3 | 2 | | | 16.0 A | 5 | | | | | 1-1/2 | | | 5 | | 17.0 A | | | | | | | | | | | 17.5 A | | | | | | 3 | | | | | 19.6 A | | | | | | | | | | | 20.0 A | | 7-1/2 | | | | | | | | | 21.0 A | | | | | | | | | | | 22.0 A | | | | | 2 | | | | | | 24.0 A | | | | | | | | 3 | | | 25.0 A | 7-1/2 | | | | | | | | | | 25.3 A | | | | | | | | | | | 27.0 A | | 10 | | | | 5 | | | | | 28.0 A | | | | | | | | | 7-1/2 | | 29.0 A | | | | | | | | | | | 32.0 A | 10 | | | | | | | | | | 32.2 A | | | | | | | | | | | 34.0 A | | | | | | | | | | | 38.0 A | | | | | | | 7-1/2 | 5 | | | 40.0 A | | | | | | | | | | | 41.0 A | | 15 | | | | | | | | | 42.0 A | | | | | | | 7-1/2 | | | | 46.0 A | 15 | | | | | | | | | | 48.3 A | | | | | | | | | | | 50.0 A | | | | | | | | | | | 52.0 A | | | | | | | | | | | 54.0 A | | | | | | | | | 15 | | 55.0 A | | | | | | 5 | | | | | 56.0 A | | | | | | | 10 | | | | 57.5 A | | | | | | | | 7-1/2 | | | 58.0 A | | | | | | | | | | | 62.0 A | 20 | | | | | | | | | | 62.1 A | | | | | | | | | | | 65.0 A | | | | | | | | | | | 68.0 A | | | | | | | | | 20 | | 72.0 A | | | | | | | | | | | 76.0 A | | | | | | | | | | | 77.0 A | | | | | | | | | | | 78.2 A | 25 | | | | | | | | | | 80.0 A | | | | | | 7-1/2 | | | | | 89.0 A | | | | | | | | | 25 | | 125 A | | | | | | | | | | | 125 A | | | | | | | | | | | 150 A | | | | | | | | | | | 150 A | | | | | | | | | | | 175 A | | | | | | | | | | | 175 A | | | | | | | | | | | 200 A | | | | | | | | | | | 200 A | | | | | | | | | | | 225 A | | | | | | | | | | | 225 A | | | | | | | | | | | 250 A | | | | | | | | | | | | | | | | | | | | | | | | | | | | | | | | | | | | | | | | | | | | | | | | | | | | | | | | | | | | | | | | | | | | | | | | | | | | | | | | | | | | | | | | | | | | | | | | | | | | | | | | | | | | | | | | | | | | | | | | | | | | | | | | | | | | | | | | | | | | | | | | | | | | | | | | | | | | | | | | | | | | | | | | | | | | | | | | | | | | | | | | | | | | | | | | | | | | | | | | | | | |
| | | | | | | | | | | 15.2 A | | | | 15 | | | 3 | 2 | | | 16.0 A | 5 | | | | | 1-1/2 | | | 5 | | 17.0 A | | | | | | | | | | | 17.5 A | | | | | | 3 | | | | | 19.6 A | | | | | | | | | | | 20.0 A | | 7-1/2 | | | | | | | | | 21.0 A | | | | | | | | | | | 22.0 A | | | | | 2 | | | | | | 24.0 A | | | | | | | | 3 | | | 25.0 A | 7-1/2 | | | | | | | | | | 25.3 A | | | | | | | | | | | 27.0 A | | 10 | | | | 5 | | | | | 28.0 A | | | | | | | | | 7-1/2 | | 29.0 A | | | | | | | | | | | 32.0 A | 10 | | | | | | | | | | 32.2 A | | | | | | | | | | | 34.0 A | | | | | | | | | | | 38.0 A | | | | | | | 7-1/2 | 5 | | | 40.0 A | | | | | | | | | | | 41.0 A | | 15 | | | | | | | | | 42.0 A | | | | | | | 7-1/2 | | | | 46.0 A | 15 | | | | | | | | | | 48.3 A | | | | | | | | | | | 50.0 A | | | | | | | | | | | 52.0 A | | | | | | | | | | | 54.0 A | | | | | | | | | 15 | | 55.0 A | | | | | | 5 | | | | | 56.0 A | | | | | | | 10 | | | | 57.5 A | | | | | | | | 7-1/2 | | | 58.0 A | | | | | | | | | | | 62.0 A | 20 | | | | | | | | | | 62.1 A | | | | | | | | | | | 65.0 A | | | | | | | | | | | 68.0 A | | | | | | | | | 20 | | 72.0 A | | | | | | | | | | | 76.0 A | | | | | | | | | | | 77.0 A | | | | | | | | | | | 78.2 A | 25 | | | | | | | | | | 80.0 A | | | | | | 7-1/2 | | | | | 89.0 A | | | | | | | | | 25 | | 125 A | | | | | | | | | | | 125 A | | | | | | | | | | | 150 A | | | | | | | | | | | 150 A | | | | | | | | | | | 175 A | | | | | | | | | | | 175 A | | | | | | | | | | | 200 A | | | | | | | | | | | 200 A | | | | | | | | | | | 225 A | | | | | | | | | | | 225 A | | | | | | | | | | | 250 A | | | | | | | | | | | | | | | | | | | | | | | | | | | | | | | | | | | | | | | | | | | | | | | | | | | | | | | | | | | | | | | | | | | | | | | | | | | | | | | | | | | | | | | | | | | | | | | | | | | | | | | | | | | | | | | | | | | | | | | | | | | | | | | | | | | | | | | | | | | | | | | | | | | | | | | | | | | | | | | | | | | | | | | | | | | | | | | | | | | | | | | | | | | | | | | | | | | | | | | | | | | | | | | | | | | | | | |
| | | | 15 | | | 3 | 2 | | | 16.0 A | 5 | | | | | 1-1/2 | | | 5 | | 17.0 A | | | | | | | | | | | 17.5 A | | | | | | 3 | | | | | 19.6 A | | | | | | | | | | | 20.0 A | | 7-1/2 | | | | | | | | | 21.0 A | | | | | | | | | | | 22.0 A | | | | | 2 | | | | | | 24.0 A | | | | | | | | 3 | | | 25.0 A | 7-1/2 | | | | | | | | | | 25.3 A | | | | | | | | | | | 27.0 A | | 10 | | | | 5 | | | | | 28.0 A | | | | | | | | | 7-1/2 | | 29.0 A | | | | | | | | | | | 32.0 A | 10 | | | | | | | | | | 32.2 A | | | | | | | | | | | 34.0 A | | | | | | | | | | | 38.0 A | | | | | | | 7-1/2 | 5 | | | 40.0 A | | | | | | | | | | | 41.0 A | | 15 | | | | | | | | | 42.0 A | | | | | | | 7-1/2 | | | | 46.0 A | 15 | | | | | | | | | | 48.3 A | | | | | | | | | | | 50.0 A | | | | | | | | | | | 52.0 A | | | | | | | | | | | 54.0 A | | | | | | | | | 15 | | 55.0 A | | | | | | 5 | | | | | 56.0 A | | | | | | | 10 | | | | 57.5 A | | | | | | | | 7-1/2 | | | 58.0 A | | | | | | | | | | | 62.0 A | 20 | | | | | | | | | | 62.1 A | | | | | | | | | | | 65.0 A | | | | | | | | | | | 68.0 A | | | | | | | | | 20 | | 72.0 A | | | | | | | | | | | 76.0 A | | | | | | | | | | | 77.0 A | | | | | | | | | | | 78.2 A | 25 | | | | | | | | | | 80.0 A | | | | | | 7-1/2 | | | | | 89.0 A | | | | | | | | | 25 | | 125 A | | | | | | | | | | | 125 A | | | | | | | | | | | 150 A | | | | | | | | | | | 150 A | | | | | | | | | | | 175 A | | | | | | | | | | | 175 A | | | | | | | | | | | 200 A | | | | | | | | | | | 200 A | | | | | | | | | | | 225 A | | | | | | | | | | | 225 A | | | | | | | | | | | 250 A | | | | | | | | | | | | | | | | | | | | | | | | | | | | | | | | | | | | | | | | | | | | | | | | | | | | | | | | | | | | | | | | | | | | | | | | | | | | | | | | | | | | | | | | | | | | | | | | | | | | | | | | | | | | | | | | | | | | | | | | | | | | | | | | | | | | | | | | | | | | | | | | | | | | | | | | | | | | | | | | | | | | | | | | | | | | | | | | | | | | | | | | | | | | | | | | | | | | | | | | | | | | | | | | | | | | | | | | | | | | | | | | | |
| 5 | | | | | 1-1/2 | | | 5 | | 17.0 A | | | | | | | | | | | 17.5 A | | | | | | 3 | | | | | 19.6 A | | | | | | | | | | | 20.0 A | | 7-1/2 | | | | | | | | | 21.0 A | | | | | | | | | | | 22.0 A | | | | | 2 | | | | | | 24.0 A | | | | | | | | 3 | | | 25.0 A | 7-1/2 | | | | | | | | | | 25.3 A | | | | | | | | | | | 27.0 A | | 10 | | | | 5 | | | | | 28.0 A | | | | | | | | | 7-1/2 | | 29.0 A | | | | | | | | | | | 32.0 A | 10 | | | | | | | | | | 32.2 A | | | | | | | | | | | 34.0 A | | | | | | | | | | | 38.0 A | | | | | | | 7-1/2 | 5 | | | 40.0 A | | | | | | | | | | | 41.0 A | | 15 | | | | | | | | | 42.0 A | | | | | | | 7-1/2 | | | | 46.0 A | 15 | | | | | | | | | | 48.3 A | | | | | | | | | | | 50.0 A | | | | | | | | | | | 52.0 A | | | | | | | | | | | 54.0 A | | | | | | | | | 15 | | 55.0 A | | | | | | 5 | | | | | 56.0 A | | | | | | | 10 | | | | 57.5 A | | | | | | | | 7-1/2 | | | 58.0 A | | | | | | | | | | | 62.0 A | 20 | | | | | | | | | | 62.1 A | | | | | | | | | | | 65.0 A | | | | | | | | | | | 68.0 A | | | | | | | | | 20 | | 72.0 A | | | | | | | | | | | 76.0 A | | | | | | | | | | | 77.0 A | | | | | | | | | | | 78.2 A | 25 | | | | | | | | | | 80.0 A | | | | | | 7-1/2 | | | | | 89.0 A | | | | | | | | | 25 | | 125 A | | | | | | | | | | | 125 A | | | | | | | | | | | 150 A | | | | | | | | | | | 150 A | | | | | | | | | | | 175 A | | | | | | | | | | | 175 A | | | | | | | | | | | 200 A | | | | | | | | | | | 200 A | | | | | | | | | | | 225 A | | | | | | | | | | | 225 A | | | | | | | | | | | 250 A | | | | | | | | | | | | | | | | | | | | | | | | | | | | | | | | | | | | | | | | | | | | | | | | | | | | | | | | | | | | | | | | | | | | | | | | | | | | | | | | | | | | | | | | | | | | | | | | | | | | | | | | | | | | | | | | | | | | | | | | | | | | | | | | | | | | | | | | | | | | | | | | | | | | | | | | | | | | | | | | | | | | | | | | | | | | | | | | | | | | | | | | | | | | | | | | | | | | | | | | | | | | | | | | | | | | | | | | | | | | | | | | | | | | | | | | | | | | |
| | | | | | | | | | | 17.5 A | | | | | | 3 | | | | | 19.6 A | | | | | | | | | | | 20.0 A | | 7-1/2 | | | | | | | | | 21.0 A | | | | | | | | | | | 22.0 A | | | | | 2 | | | | | | 24.0 A | | | | | | | | 3 | | | 25.0 A | 7-1/2 | | | | | | | | | | 25.3 A | | | | | | | | | | | 27.0 A | | 10 | | | | 5 | | | | | 28.0 A | | | | | | | | | 7-1/2 | | 29.0 A | | | | | | | | | | | 32.0 A | 10 | | | | | | | | | | 32.2 A | | | | | | | | | | | 34.0 A | | | | | | | | | | | 38.0 A | | | | | | | 7-1/2 | 5 | | | 40.0 A | | | | | | | | | | | 41.0 A | | 15 | | | | | | | | | 42.0 A | | | | | | | 7-1/2 | | | | 46.0 A | 15 | | | | | | | | | | 48.3 A | | | | | | | | | | | 50.0 A | | | | | | | | | | | 52.0 A | | | | | | | | | | | 54.0 A | | | | | | | | | 15 | | 55.0 A | | | | | | 5 | | | | | 56.0 A | | | | | | | 10 | | | | 57.5 A | | | | | | | | 7-1/2 | | | 58.0 A | | | | | | | | | | | 62.0 A | 20 | | | | | | | | | | 62.1 A | | | | | | | | | | | 65.0 A | | | | | | | | | | | 68.0 A | | | | | | | | | 20 | | 72.0 A | | | | | | | | | | | 76.0 A | | | | | | | | | | | 77.0 A | | | | | | | | | | | 78.2 A | 25 | | | | | | | | | | 80.0 A | | | | | | 7-1/2 | | | | | 89.0 A | | | | | | | | | 25 | | 125 A | | | | | | | | | | | 125 A | | | | | | | | | | | 150 A | | | | | | | | | | | 150 A | | | | | | | | | | | 175 A | | | | | | | | | | | 175 A | | | | | | | | | | | 200 A | | | | | | | | | | | 200 A | | | | | | | | | | | 225 A | | | | | | | | | | | 225 A | | | | | | | | | | | 250 A | | | | | | | | | | | | | | | | | | | | | | | | | | | | | | | | | | | | | | | | | | | | | | | | | | | | | | | | | | | | | | | | | | | | | | | | | | | | | | | | | | | | | | | | | | | | | | | | | | | | | | | | | | | | | | | | | | | | | | | | | | | | | | | | | | | | | | | | | | | | | | | | | | | | | | | | | | | | | | | | | | | | | | | | | | | | | | | | | | | | | | | | | | | | | | | | | | | | | | | | | | | | | | | | | | | | | | | | | | | | | | | | | | | | | | | | | | | | | | | | | | | | | | | |
| | | | | | 3 | | | | | 19.6 A | | | | | | | | | | | 20.0 A | | 7-1/2 | | | | | | | | | 21.0 A | | | | | | | | | | | 22.0 A | | | | | 2 | | | | | | 24.0 A | | | | | | | | 3 | | | 25.0 A | 7-1/2 | | | | | | | | | | 25.3 A | | | | | | | | | | | 27.0 A | | 10 | | | | 5 | | | | | 28.0 A | | | | | | | | | 7-1/2 | | 29.0 A | | | | | | | | | | | 32.0 A | 10 | | | | | | | | | | 32.2 A | | | | | | | | | | | 34.0 A | | | | | | | | | | | 38.0 A | | | | | | | 7-1/2 | 5 | | | 40.0 A | | | | | | | | | | | 41.0 A | | 15 | | | | | | | | | 42.0 A | | | | | | | 7-1/2 | | | | 46.0 A | 15 | | | | | | | | | | 48.3 A | | | | | | | | | | | 50.0 A | | | | | | | | | | | 52.0 A | | | | | | | | | | | 54.0 A | | | | | | | | | 15 | | 55.0 A | | | | | | 5 | | | | | 56.0 A | | | | | | | 10 | | | | 57.5 A | | | | | | | | 7-1/2 | | | 58.0 A | | | | | | | | | | | 62.0 A | 20 | | | | | | | | | | 62.1 A | | | | | | | | | | | 65.0 A | | | | | | | | | | | 68.0 A | | | | | | | | | 20 | | 72.0 A | | | | | | | | | | | 76.0 A | | | | | | | | | | | 77.0 A | | | | | | | | | | | 78.2 A | 25 | | | | | | | | | | 80.0 A | | | | | | 7-1/2 | | | | | 89.0 A | | | | | | | | | 25 | | 125 A | | | | | | | | | | | 125 A | | | | | | | | | | | 150 A | | | | | | | | | | | 150 A | | | | | | | | | | | 175 A | | | | | | | | | | | 175 A | | | | | | | | | | | 200 A | | | | | | | | | | | 200 A | | | | | | | | | | | 225 A | | | | | | | | | | | 225 A | | | | | | | | | | | 250 A | | | | | | | | | | | | | | | | | | | | | | | | | | | | | | | | | | | | | | | | | | | | | | | | | | | | | | | | | | | | | | | | | | | | | | | | | | | | | | | | | | | | | | | | | | | | | | | | | | | | | | | | | | | | | | | | | | | | | | | | | | | | | | | | | | | | | | | | | | | | | | | | | | | | | | | | | | | | | | | | | | | | | | | | | | | | | | | | | | | | | | | | | | | | | | | | | | | | | | | | | | | | | | | | | | | | | | | | | | | | | | | | | | | | | | | | | | | | | | | | | | | | | | | | | | | | | | | | | | |
| | | | | | | | | | | 20.0 A | | 7-1/2 | | | | | | | | | 21.0 A | | | | | | | | | | | 22.0 A | | | | | 2 | | | | | | 24.0 A | | | | | | | | 3 | | | 25.0 A | 7-1/2 | | | | | | | | | | 25.3 A | | | | | | | | | | | 27.0 A | | 10 | | | | 5 | | | | | 28.0 A | | | | | | | | | 7-1/2 | | 29.0 A | | | | | | | | | | | 32.0 A | 10 | | | | | | | | | | 32.2 A | | | | | | | | | | | 34.0 A | | | | | | | | | | | 38.0 A | | | | | | | 7-1/2 | 5 | | | 40.0 A | | | | | | | | | | | 41.0 A | | 15 | | | | | | | | | 42.0 A | | | | | | | 7-1/2 | | | | 46.0 A | 15 | | | | | | | | | | 48.3 A | | | | | | | | | | | 50.0 A | | | | | | | | | | | 52.0 A | | | | | | | | | | | 54.0 A | | | | | | | | | 15 | | 55.0 A | | | | | | 5 | | | | | 56.0 A | | | | | | | 10 | | | | 57.5 A | | | | | | | | 7-1/2 | | | 58.0 A | | | | | | | | | | | 62.0 A | 20 | | | | | | | | | | 62.1 A | | | | | | | | | | | 65.0 A | | | | | | | | | | | 68.0 A | | | | | | | | | 20 | | 72.0 A | | | | | | | | | | | 76.0 A | | | | | | | | | | | 77.0 A | | | | | | | | | | | 78.2 A | 25 | | | | | | | | | | 80.0 A | | | | | | 7-1/2 | | | | | 89.0 A | | | | | | | | | 25 | | 125 A | | | | | | | | | | | 125 A | | | | | | | | | | | 150 A | | | | | | | | | | | 150 A | | | | | | | | | | | 175 A | | | | | | | | | | | 175 A | | | | | | | | | | | 200 A | | | | | | | | | | | 200 A | | | | | | | | | | | 225 A | | | | | | | | | | | 225 A | | | | | | | | | | | 250 A | | | | | | | | | | | | | | | | | | | | | | | | | | | | | | | | | | | | | | | | | | | | | | | | | | | | | | | | | | | | | | | | | | | | | | | | | | | | | | | | | | | | | | | | | | | | | | | | | | | | | | | | | | | | | | | | | | | | | | | | | | | | | | | | | | | | | | | | | | | | | | | | | | | | | | | | | | | | | | | | | | | | | | | | | | | | | | | | | | | | | | | | | | | | | | | | | | | | | | | | | | | | | | | | | | | | | | | | | | | | | | | | | | | | | | | | | | | | | | | | | | | | | | | | | | | | | | | | | | | | | | | | | | | | | |
| | 7-1/2 | | | | | | | | | 21.0 A | | | | | | | | | | | 22.0 A | | | | | 2 | | | | | | 24.0 A | | | | | | | | 3 | | | 25.0 A | 7-1/2 | | | | | | | | | | 25.3 A | | | | | | | | | | | 27.0 A | | 10 | | | | 5 | | | | | 28.0 A | | | | | | | | | 7-1/2 | | 29.0 A | | | | | | | | | | | 32.0 A | 10 | | | | | | | | | | 32.2 A | | | | | | | | | | | 34.0 A | | | | | | | | | | | 38.0 A | | | | | | | 7-1/2 | 5 | | | 40.0 A | | | | | | | | | | | 41.0 A | | 15 | | | | | | | | | 42.0 A | | | | | | | 7-1/2 | | | | 46.0 A | 15 | | | | | | | | | | 48.3 A | | | | | | | | | | | 50.0 A | | | | | | | | | | | 52.0 A | | | | | | | | | | | 54.0 A | | | | | | | | | 15 | | 55.0 A | | | | | | 5 | | | | | 56.0 A | | | | | | | 10 | | | | 57.5 A | | | | | | | | 7-1/2 | | | 58.0 A | | | | | | | | | | | 62.0 A | 20 | | | | | | | | | | 62.1 A | | | | | | | | | | | 65.0 A | | | | | | | | | | | 68.0 A | | | | | | | | | 20 | | 72.0 A | | | | | | | | | | | 76.0 A | | | | | | | | | | | 77.0 A | | | | | | | | | | | 78.2 A | 25 | | | | | | | | | | 80.0 A | | | | | | 7-1/2 | | | | | 89.0 A | | | | | | | | | 25 | | 125 A | | | | | | | | | | | 125 A | | | | | | | | | | | 150 A | | | | | | | | | | | 150 A | | | | | | | | | | | 175 A | | | | | | | | | | | 175 A | | | | | | | | | | | 200 A | | | | | | | | | | | 200 A | | | | | | | | | | | 225 A | | | | | | | | | | | 225 A | | | | | | | | | | | 250 A | | | | | | | | | | | | | | | | | | | | | | | | | | | | | | | | | | | | | | | | | | | | | | | | | | | | | | | | | | | | | | | | | | | | | | | | | | | | | | | | | | | | | | | | | | | | | | | | | | | | | | | | | | | | | | | | | | | | | | | | | | | | | | | | | | | | | | | | | | | | | | | | | | | | | | | | | | | | | | | | | | | | | | | | | | | | | | | | | | | | | | | | | | | | | | | | | | | | | | | | | | | | | | | | | | | | | | | | | | | | | | | | | | | | | | | | | | | | | | | | | | | | | | | | | | | | | | | | | | | | | | | | | | | | | | | | | | | | | | | | |
| | | | | | | | | | | 22.0 A | | | | | 2 | | | | | | 24.0 A | | | | | | | | 3 | | | 25.0 A | 7-1/2 | | | | | | | | | | 25.3 A | | | | | | | | | | | 27.0 A | | 10 | | | | 5 | | | | | 28.0 A | | | | | | | | | 7-1/2 | | 29.0 A | | | | | | | | | | | 32.0 A | 10 | | | | | | | | | | 32.2 A | | | | | | | | | | | 34.0 A | | | | | | | | | | | 38.0 A | | | | | | | 7-1/2 | 5 | | | 40.0 A | | | | | | | | | | | 41.0 A | | 15 | | | | | | | | | 42.0 A | | | | | | | 7-1/2 | | | | 46.0 A | 15 | | | | | | | | | | 48.3 A | | | | | | | | | | | 50.0 A | | | | | | | | | | | 52.0 A | | | | | | | | | | | 54.0 A | | | | | | | | | 15 | | 55.0 A | | | | | | 5 | | | | | 56.0 A | | | | | | | 10 | | | | 57.5 A | | | | | | | | 7-1/2 | | | 58.0 A | | | | | | | | | | | 62.0 A | 20 | | | | | | | | | | 62.1 A | | | | | | | | | | | 65.0 A | | | | | | | | | | | 68.0 A | | | | | | | | | 20 | | 72.0 A | | | | | | | | | | | 76.0 A | | | | | | | | | | | 77.0 A | | | | | | | | | | | 78.2 A | 25 | | | | | | | | | | 80.0 A | | | | | | 7-1/2 | | | | | 89.0 A | | | | | | | | | 25 | | 125 A | | | | | | | | | | | 125 A | | | | | | | | | | | 150 A | | | | | | | | | | | 150 A | | | | | | | | | | | 175 A | | | | | | | | | | | 175 A | | | | | | | | | | | 200 A | | | | | | | | | | | 200 A | | | | | | | | | | | 225 A | | | | | | | | | | | 225 A | | | | | | | | | | | 250 A | | | | | | | | | | | | | | | | | | | | | | | | | | | | | | | | | | | | | | | | | | | | | | | | | | | | | | | | | | | | | | | | | | | | | | | | | | | | | | | | | | | | | | | | | | | | | | | | | | | | | | | | | | | | | | | | | | | | | | | | | | | | | | | | | | | | | | | | | | | | | | | | | | | | | | | | | | | | | | | | | | | | | | | | | | | | | | | | | | | | | | | | | | | | | | | | | | | | | | | | | | | | | | | | | | | | | | | | | | | | | | | | | | | | | | | | | | | | | | | | | | | | | | | | | | | | | | | | | | | | | | | | | | | | | | | | | | | | | | | | | | | | | | | | | | | |
| | | | | 2 | | | | | | 24.0 A | | | | | | | | 3 | | | 25.0 A | 7-1/2 | | | | | | | | | | 25.3 A | | | | | | | | | | | 27.0 A | | 10 | | | | 5 | | | | | 28.0 A | | | | | | | | | 7-1/2 | | 29.0 A | | | | | | | | | | | 32.0 A | 10 | | | | | | | | | | 32.2 A | | | | | | | | | | | 34.0 A | | | | | | | | | | | 38.0 A | | | | | | | 7-1/2 | 5 | | | 40.0 A | | | | | | | | | | | 41.0 A | | 15 | | | | | | | | | 42.0 A | | | | | | | 7-1/2 | | | | 46.0 A | 15 | | | | | | | | | | 48.3 A | | | | | | | | | | | 50.0 A | | | | | | | | | | | 52.0 A | | | | | | | | | | | 54.0 A | | | | | | | | | 15 | | 55.0 A | | | | | | 5 | | | | | 56.0 A | | | | | | | 10 | | | | 57.5 A | | | | | | | | 7-1/2 | | | 58.0 A | | | | | | | | | | | 62.0 A | 20 | | | | | | | | | | 62.1 A | | | | | | | | | | | 65.0 A | | | | | | | | | | | 68.0 A | | | | | | | | | 20 | | 72.0 A | | | | | | | | | | | 76.0 A | | | | | | | | | | | 77.0 A | | | | | | | | | | | 78.2 A | 25 | | | | | | | | | | 80.0 A | | | | | | 7-1/2 | | | | | 89.0 A | | | | | | | | | 25 | | 125 A | | | | | | | | | | | 125 A | | | | | | | | | | | 150 A | | | | | | | | | | | 150 A | | | | | | | | | | | 175 A | | | | | | | | | | | 175 A | | | | | | | | | | | 200 A | | | | | | | | | | | 200 A | | | | | | | | | | | 225 A | | | | | | | | | | | 225 A | | | | | | | | | | | 250 A | | | | | | | | | | | | | | | | | | | | | | | | | | | | | | | | | | | | | | | | | | | | | | | | | | | | | | | | | | | | | | | | | | | | | | | | | | | | | | | | | | | | | | | | | | | | | | | | | | | | | | | | | | | | | | | | | | | | | | | | | | | | | | | | | | | | | | | | | | | | | | | | | | | | | | | | | | | | | | | | | | | | | | | | | | | | | | | | | | | | | | | | | | | | | | | | | | | | | | | | | | | | | | | | | | | | | | | | | | | | | | | | | | | | | | | | | | | | | | | | | | | | | | | | | | | | | | | | | | | | | | | | | | | | | | | | | | | | | | | | | | | | | | | | | | | | | | | | | | | | | | |
| | | | | | | | 3 | | | 25.0 A | 7-1/2 | | | | | | | | | | 25.3 A | | | | | | | | | | | 27.0 A | | 10 | | | | 5 | | | | | 28.0 A | | | | | | | | | 7-1/2 | | 29.0 A | | | | | | | | | | | 32.0 A | 10 | | | | | | | | | | 32.2 A | | | | | | | | | | | 34.0 A | | | | | | | | | | | 38.0 A | | | | | | | 7-1/2 | 5 | | | 40.0 A | | | | | | | | | | | 41.0 A | | 15 | | | | | | | | | 42.0 A | | | | | | | 7-1/2 | | | | 46.0 A | 15 | | | | | | | | | | 48.3 A | | | | | | | | | | | 50.0 A | | | | | | | | | | | 52.0 A | | | | | | | | | | | 54.0 A | | | | | | | | | 15 | | 55.0 A | | | | | | 5 | | | | | 56.0 A | | | | | | | 10 | | | | 57.5 A | | | | | | | | 7-1/2 | | | 58.0 A | | | | | | | | | | | 62.0 A | 20 | | | | | | | | | | 62.1 A | | | | | | | | | | | 65.0 A | | | | | | | | | | | 68.0 A | | | | | | | | | 20 | | 72.0 A | | | | | | | | | | | 76.0 A | | | | | | | | | | | 77.0 A | | | | | | | | | | | 78.2 A | 25 | | | | | | | | | | 80.0 A | | | | | | 7-1/2 | | | | | 89.0 A | | | | | | | | | 25 | | 125 A | | | | | | | | | | | 125 A | | | | | | | | | | | 150 A | | | | | | | | | | | 150 A | | | | | | | | | | | 175 A | | | | | | | | | | | 175 A | | | | | | | | | | | 200 A | | | | | | | | | | | 200 A | | | | | | | | | | | 225 A | | | | | | | | | | | 225 A | | | | | | | | | | | 250 A | | | | | | | | | | | | | | | | | | | | | | | | | | | | | | | | | | | | | | | | | | | | | | | | | | | | | | | | | | | | | | | | | | | | | | | | | | | | | | | | | | | | | | | | | | | | | | | | | | | | | | | | | | | | | | | | | | | | | | | | | | | | | | | | | | | | | | | | | | | | | | | | | | | | | | | | | | | | | | | | | | | | | | | | | | | | | | | | | | | | | | | | | | | | | | | | | | | | | | | | | | | | | | | | | | | | | | | | | | | | | | | | | | | | | | | | | | | | | | | | | | | | | | | | | | | | | | | | | | | | | | | | | | | | | | | | | | | | | | | | | | | | | | | | | | | | | | | | | | | | | | | | | | | | | | | | | |
| 7-1/2 | | | | | | | | | | 25.3 A | | | | | | | | | | | 27.0 A | | 10 | | | | 5 | | | | | 28.0 A | | | | | | | | | 7-1/2 | | 29.0 A | | | | | | | | | | | 32.0 A | 10 | | | | | | | | | | 32.2 A | | | | | | | | | | | 34.0 A | | | | | | | | | | | 38.0 A | | | | | | | 7-1/2 | 5 | | | 40.0 A | | | | | | | | | | | 41.0 A | | 15 | | | | | | | | | 42.0 A | | | | | | | 7-1/2 | | | | 46.0 A | 15 | | | | | | | | | | 48.3 A | | | | | | | | | | | 50.0 A | | | | | | | | | | | 52.0 A | | | | | | | | | | | 54.0 A | | | | | | | | | 15 | | 55.0 A | | | | | | 5 | | | | | 56.0 A | | | | | | | 10 | | | | 57.5 A | | | | | | | | 7-1/2 | | | 58.0 A | | | | | | | | | | | 62.0 A | 20 | | | | | | | | | | 62.1 A | | | | | | | | | | | 65.0 A | | | | | | | | | | | 68.0 A | | | | | | | | | 20 | | 72.0 A | | | | | | | | | | | 76.0 A | | | | | | | | | | | 77.0 A | | | | | | | | | | | 78.2 A | 25 | | | | | | | | | | 80.0 A | | | | | | 7-1/2 | | | | | 89.0 A | | | | | | | | | 25 | | 125 A | | | | | | | | | | | 125 A | | | | | | | | | | | 150 A | | | | | | | | | | | 150 A | | | | | | | | | | | 175 A | | | | | | | | | | | 175 A | | | | | | | | | | | 200 A | | | | | | | | | | | 200 A | | | | | | | | | | | 225 A | | | | | | | | | | | 225 A | | | | | | | | | | | 250 A | | | | | | | | | | | | | | | | | | | | | | | | | | | | | | | | | | | | | | | | | | | | | | | | | | | | | | | | | | | | | | | | | | | | | | | | | | | | | | | | | | | | | | | | | | | | | | | | | | | | | | | | | | | | | | | | | | | | | | | | | | | | | | | | | | | | | | | | | | | | | | | | | | | | | | | | | | | | | | | | | | | | | | | | | | | | | | | | | | | | | | | | | | | | | | | | | | | | | | | | | | | | | | | | | | | | | | | | | | | | | | | | | | | | | | | | | | | | | | | | | | | | | | | | | | | | | | | | | | | | | | | | | | | | | | | | | | | | | | | | | | | | | | | | | | | | | | | | | | | | | | | | | | | | | | | | | | | | | | | | | | | | |
| | | | | | | | | | | 27.0 A | | 10 | | | | 5 | | | | | 28.0 A | | | | | | | | | 7-1/2 | | 29.0 A | | | | | | | | | | | 32.0 A | 10 | | | | | | | | | | 32.2 A | | | | | | | | | | | 34.0 A | | | | | | | | | | | 38.0 A | | | | | | | 7-1/2 | 5 | | | 40.0 A | | | | | | | | | | | 41.0 A | | 15 | | | | | | | | | 42.0 A | | | | | | | 7-1/2 | | | | 46.0 A | 15 | | | | | | | | | | 48.3 A | | | | | | | | | | | 50.0 A | | | | | | | | | | | 52.0 A | | | | | | | | | | | 54.0 A | | | | | | | | | 15 | | 55.0 A | | | | | | 5 | | | | | 56.0 A | | | | | | | 10 | | | | 57.5 A | | | | | | | | 7-1/2 | | | 58.0 A | | | | | | | | | | | 62.0 A | 20 | | | | | | | | | | 62.1 A | | | | | | | | | | | 65.0 A | | | | | | | | | | | 68.0 A | | | | | | | | | 20 | | 72.0 A | | | | | | | | | | | 76.0 A | | | | | | | | | | | 77.0 A | | | | | | | | | | | 78.2 A | 25 | | | | | | | | | | 80.0 A | | | | | | 7-1/2 | | | | | 89.0 A | | | | | | | | | 25 | | 125 A | | | | | | | | | | | 125 A | | | | | | | | | | | 150 A | | | | | | | | | | | 150 A | | | | | | | | | | | 175 A | | | | | | | | | | | 175 A | | | | | | | | | | | 200 A | | | | | | | | | | | 200 A | | | | | | | | | | | 225 A | | | | | | | | | | | 225 A | | | | | | | | | | | 250 A | | | | | | | | | | | | | | | | | | | | | | | | | | | | | | | | | | | | | | | | | | | | | | | | | | | | | | | | | | | | | | | | | | | | | | | | | | | | | | | | | | | | | | | | | | | | | | | | | | | | | | | | | | | | | | | | | | | | | | | | | | | | | | | | | | | | | | | | | | | | | | | | | | | | | | | | | | | | | | | | | | | | | | | | | | | | | | | | | | | | | | | | | | | | | | | | | | | | | | | | | | | | | | | | | | | | | | | | | | | | | | | | | | | | | | | | | | | | | | | | | | | | | | | | | | | | | | | | | | | | | | | | | | | | | | | | | | | | | | | | | | | | | | | | | | | | | | | | | | | | | | | | | | | | | | | | | | | | | | | | | | | | | | | | | | | | | | | |
| | 10 | | | | 5 | | | | | 28.0 A | | | | | | | | | 7-1/2 | | 29.0 A | | | | | | | | | | | 32.0 A | 10 | | | | | | | | | | 32.2 A | | | | | | | | | | | 34.0 A | | | | | | | | | | | 38.0 A | | | | | | | 7-1/2 | 5 | | | 40.0 A | | | | | | | | | | | 41.0 A | | 15 | | | | | | | | | 42.0 A | | | | | | | 7-1/2 | | | | 46.0 A | 15 | | | | | | | | | | 48.3 A | | | | | | | | | | | 50.0 A | | | | | | | | | | | 52.0 A | | | | | | | | | | | 54.0 A | | | | | | | | | 15 | | 55.0 A | | | | | | 5 | | | | | 56.0 A | | | | | | | 10 | | | | 57.5 A | | | | | | | | 7-1/2 | | | 58.0 A | | | | | | | | | | | 62.0 A | 20 | | | | | | | | | | 62.1 A | | | | | | | | | | | 65.0 A | | | | | | | | | | | 68.0 A | | | | | | | | | 20 | | 72.0 A | | | | | | | | | | | 76.0 A | | | | | | | | | | | 77.0 A | | | | | | | | | | | 78.2 A | 25 | | | | | | | | | | 80.0 A | | | | | | 7-1/2 | | | | | 89.0 A | | | | | | | | | 25 | | 125 A | | | | | | | | | | | 125 A | | | | | | | | | | | 150 A | | | | | | | | | | | 150 A | | | | | | | | | | | 175 A | | | | | | | | | | | 175 A | | | | | | | | | | | 200 A | | | | | | | | | | | 200 A | | | | | | | | | | | 225 A | | | | | | | | | | | 225 A | | | | | | | | | | | 250 A | | | | | | | | | | | | | | | | | | | | | | | | | | | | | | | | | | | | | | | | | | | | | | | | | | | | | | | | | | | | | | | | | | | | | | | | | | | | | | | | | | | | | | | | | | | | | | | | | | | | | | | | | | | | | | | | | | | | | | | | | | | | | | | | | | | | | | | | | | | | | | | | | | | | | | | | | | | | | | | | | | | | | | | | | | | | | | | | | | | | | | | | | | | | | | | | | | | | | | | | | | | | | | | | | | | | | | | | | | | | | | | | | | | | | | | | | | | | | | | | | | | | | | | | | | | | | | | | | | | | | | | | | | | | | | | | | | | | | | | | | | | | | | | | | | | | | | | | | | | | | | | | | | | | | | | | | | | | | | | | | | | | | | | | | | | | | | | | | | | | | | | | | | |
| | | | | | | | | 7-1/2 | | 29.0 A | | | | | | | | | | | 32.0 A | 10 | | | | | | | | | | 32.2 A | | | | | | | | | | | 34.0 A | | | | | | | | | | | 38.0 A | | | | | | | 7-1/2 | 5 | | | 40.0 A | | | | | | | | | | | 41.0 A | | 15 | | | | | | | | | 42.0 A | | | | | | | 7-1/2 | | | | 46.0 A | 15 | | | | | | | | | | 48.3 A | | | | | | | | | | | 50.0 A | | | | | | | | | | | 52.0 A | | | | | | | | | | | 54.0 A | | | | | | | | | 15 | | 55.0 A | | | | | | 5 | | | | | 56.0 A | | | | | | | 10 | | | | 57.5 A | | | | | | | | 7-1/2 | | | 58.0 A | | | | | | | | | | | 62.0 A | 20 | | | | | | | | | | 62.1 A | | | | | | | | | | | 65.0 A | | | | | | | | | | | 68.0 A | | | | | | | | | 20 | | 72.0 A | | | | | | | | | | | 76.0 A | | | | | | | | | | | 77.0 A | | | | | | | | | | | 78.2 A | 25 | | | | | | | | | | 80.0 A | | | | | | 7-1/2 | | | | | 89.0 A | | | | | | | | | 25 | | 125 A | | | | | | | | | | | 125 A | | | | | | | | | | | 150 A | | | | | | | | | | | 150 A | | | | | | | | | | | 175 A | | | | | | | | | | | 175 A | | | | | | | | | | | 200 A | | | | | | | | | | | 200 A | | | | | | | | | | | 225 A | | | | | | | | | | | 225 A | | | | | | | | | | | 250 A | | | | | | | | | | | | | | | | | | | | | | | | | | | | | | | | | | | | | | | | | | | | | | | | | | | | | | | | | | | | | | | | | | | | | | | | | | | | | | | | | | | | | | | | | | | | | | | | | | | | | | | | | | | | | | | | | | | | | | | | | | | | | | | | | | | | | | | | | | | | | | | | | | | | | | | | | | | | | | | | | | | | | | | | | | | | | | | | | | | | | | | | | | | | | | | | | | | | | | | | | | | | | | | | | | | | | | | | | | | | | | | | | | | | | | | | | | | | | | | | | | | | | | | | | | | | | | | | | | | | | | | | | | | | | | | | | | | | | | | | | | | | | | | | | | | | | | | | | | | | | | | | | | | | | | | | | | | | | | | | | | | | | | | | | | | | | | | | | | | | | | | | | | | | | | | | | | | | | |
| | | | | | | | | | | 32.0 A | 10 | | | | | | | | | | 32.2 A | | | | | | | | | | | 34.0 A | | | | | | | | | | | 38.0 A | | | | | | | 7-1/2 | 5 | | | 40.0 A | | | | | | | | | | | 41.0 A | | 15 | | | | | | | | | 42.0 A | | | | | | | 7-1/2 | | | | 46.0 A | 15 | | | | | | | | | | 48.3 A | | | | | | | | | | | 50.0 A | | | | | | | | | | | 52.0 A | | | | | | | | | | | 54.0 A | | | | | | | | | 15 | | 55.0 A | | | | | | 5 | | | | | 56.0 A | | | | | | | 10 | | | | 57.5 A | | | | | | | | 7-1/2 | | | 58.0 A | | | | | | | | | | | 62.0 A | 20 | | | | | | | | | | 62.1 A | | | | | | | | | | | 65.0 A | | | | | | | | | | | 68.0 A | | | | | | | | | 20 | | 72.0 A | | | | | | | | | | | 76.0 A | | | | | | | | | | | 77.0 A | | | | | | | | | | | 78.2 A | 25 | | | | | | | | | | 80.0 A | | | | | | 7-1/2 | | | | | 89.0 A | | | | | | | | | 25 | | 125 A | | | | | | | | | | | 125 A | | | | | | | | | | | 150 A | | | | | | | | | | | 150 A | | | | | | | | | | | 175 A | | | | | | | | | | | 175 A | | | | | | | | | | | 200 A | | | | | | | | | | | 200 A | | | | | | | | | | | 225 A | | | | | | | | | | | 225 A | | | | | | | | | | | 250 A | | | | | | | | | | | | | | | | | | | | | | | | | | | | | | | | | | | | | | | | | | | | | | | | | | | | | | | | | | | | | | | | | | | | | | | | | | | | | | | | | | | | | | | | | | | | | | | | | | | | | | | | | | | | | | | | | | | | | | | | | | | | | | | | | | | | | | | | | | | | | | | | | | | | | | | | | | | | | | | | | | | | | | | | | | | | | | | | | | | | | | | | | | | | | | | | | | | | | | | | | | | | | | | | | | | | | | | | | | | | | | | | | | | | | | | | | | | | | | | | | | | | | | | | | | | | | | | | | | | | | | | | | | | | | | | | | | | | | | | | | | | | | | | | | | | | | | | | | | | | | | | | | | | | | | | | | | | | | | | | | | | | | | | | | | | | | | | | | | | | | | | | | | | | | | | | | | | | | | | | | | | | | | | | |
| 10 | | | | | | | | | | 32.2 A | | | | | | | | | | | 34.0 A | | | | | | | | | | | 38.0 A | | | | | | | 7-1/2 | 5 | | | 40.0 A | | | | | | | | | | | 41.0 A | | 15 | | | | | | | | | 42.0 A | | | | | | | 7-1/2 | | | | 46.0 A | 15 | | | | | | | | | | 48.3 A | | | | | | | | | | | 50.0 A | | | | | | | | | | | 52.0 A | | | | | | | | | | | 54.0 A | | | | | | | | | 15 | | 55.0 A | | | | | | 5 | | | | | 56.0 A | | | | | | | 10 | | | | 57.5 A | | | | | | | | 7-1/2 | | | 58.0 A | | | | | | | | | | | 62.0 A | 20 | | | | | | | | | | 62.1 A | | | | | | | | | | | 65.0 A | | | | | | | | | | | 68.0 A | | | | | | | | | 20 | | 72.0 A | | | | | | | | | | | 76.0 A | | | | | | | | | | | 77.0 A | | | | | | | | | | | 78.2 A | 25 | | | | | | | | | | 80.0 A | | | | | | 7-1/2 | | | | | 89.0 A | | | | | | | | | 25 | | 125 A | | | | | | | | | | | 125 A | | | | | | | | | | | 150 A | | | | | | | | | | | 150 A | | | | | | | | | | | 175 A | | | | | | | | | | | 175 A | | | | | | | | | | | 200 A | | | | | | | | | | | 200 A | | | | | | | | | | | 225 A | | | | | | | | | | | 225 A | | | | | | | | | | | 250 A | | | | | | | | | | | | | | | | | | | | | | | | | | | | | | | | | | | | | | | | | | | | | | | | | | | | | | | | | | | | | | | | | | | | | | | | | | | | | | | | | | | | | | | | | | | | | | | | | | | | | | | | | | | | | | | | | | | | | | | | | | | | | | | | | | | | | | | | | | | | | | | | | | | | | | | | | | | | | | | | | | | | | | | | | | | | | | | | | | | | | | | | | | | | | | | | | | | | | | | | | | | | | | | | | | | | | | | | | | | | | | | | | | | | | | | | | | | | | | | | | | | | | | | | | | | | | | | | | | | | | | | | | | | | | | | | | | | | | | | | | | | | | | | | | | | | | | | | | | | | | | | | | | | | | | | | | | | | | | | | | | | | | | | | | | | | | | | | | | | | | | | | | | | | | | | | | | | | | | | | | | | | | | | | | | | | | | | | | | | |
| | | | | | | | | | | 34.0 A | | | | | | | | | | | 38.0 A | | | | | | | 7-1/2 | 5 | | | 40.0 A | | | | | | | | | | | 41.0 A | | 15 | | | | | | | | | 42.0 A | | | | | | | 7-1/2 | | | | 46.0 A | 15 | | | | | | | | | | 48.3 A | | | | | | | | | | | 50.0 A | | | | | | | | | | | 52.0 A | | | | | | | | | | | 54.0 A | | | | | | | | | 15 | | 55.0 A | | | | | | 5 | | | | | 56.0 A | | | | | | | 10 | | | | 57.5 A | | | | | | | | 7-1/2 | | | 58.0 A | | | | | | | | | | | 62.0 A | 20 | | | | | | | | | | 62.1 A | | | | | | | | | | | 65.0 A | | | | | | | | | | | 68.0 A | | | | | | | | | 20 | | 72.0 A | | | | | | | | | | | 76.0 A | | | | | | | | | | | 77.0 A | | | | | | | | | | | 78.2 A | 25 | | | | | | | | | | 80.0 A | | | | | | 7-1/2 | | | | | 89.0 A | | | | | | | | | 25 | | 125 A | | | | | | | | | | | 125 A | | | | | | | | | | | 150 A | | | | | | | | | | | 150 A | | | | | | | | | | | 175 A | | | | | | | | | | | 175 A | | | | | | | | | | | 200 A | | | | | | | | | | | 200 A | | | | | | | | | | | 225 A | | | | | | | | | | | 225 A | | | | | | | | | | | 250 A | | | | | | | | | | | | | | | | | | | | | | | | | | | | | | | | | | | | | | | | | | | | | | | | | | | | | | | | | | | | | | | | | | | | | | | | | | | | | | | | | | | | | | | | | | | | | | | | | | | | | | | | | | | | | | | | | | | | | | | | | | | | | | | | | | | | | | | | | | | | | | | | | | | | | | | | | | | | | | | | | | | | | | | | | | | | | | | | | | | | | | | | | | | | | | | | | | | | | | | | | | | | | | | | | | | | | | | | | | | | | | | | | | | | | | | | | | | | | | | | | | | | | | | | | | | | | | | | | | | | | | | | | | | | | | | | | | | | | | | | | | | | | | | | | | | | | | | | | | | | | | | | | | | | | | | | | | | | | | | | | | | | | | | | | | | | | | | | | | | | | | | | | | | | | | | | | | | | | | | | | | | | | | | | | | | | | | | | | | | | | | | | | | | | | | |
| | | | | | | | | | | 38.0 A | | | | | | | 7-1/2 | 5 | | | 40.0 A | | | | | | | | | | | 41.0 A | | 15 | | | | | | | | | 42.0 A | | | | | | | 7-1/2 | | | | 46.0 A | 15 | | | | | | | | | | 48.3 A | | | | | | | | | | | 50.0 A | | | | | | | | | | | 52.0 A | | | | | | | | | | | 54.0 A | | | | | | | | | 15 | | 55.0 A | | | | | | 5 | | | | | 56.0 A | | | | | | | 10 | | | | 57.5 A | | | | | | | | 7-1/2 | | | 58.0 A | | | | | | | | | | | 62.0 A | 20 | | | | | | | | | | 62.1 A | | | | | | | | | | | 65.0 A | | | | | | | | | | | 68.0 A | | | | | | | | | 20 | | 72.0 A | | | | | | | | | | | 76.0 A | | | | | | | | | | | 77.0 A | | | | | | | | | | | 78.2 A | 25 | | | | | | | | | | 80.0 A | | | | | | 7-1/2 | | | | | 89.0 A | | | | | | | | | 25 | | 125 A | | | | | | | | | | | 125 A | | | | | | | | | | | 150 A | | | | | | | | | | | 150 A | | | | | | | | | | | 175 A | | | | | | | | | | | 175 A | | | | | | | | | | | 200 A | | | | | | | | | | | 200 A | | | | | | | | | | | 225 A | | | | | | | | | | | 225 A | | | | | | | | | | | 250 A | | | | | | | | | | | | | | | | | | | | | | | | | | | | | | | | | | | | | | | | | | | | | | | | | | | | | | | | | | | | | | | | | | | | | | | | | | | | | | | | | | | | | | | | | | | | | | | | | | | | | | | | | | | | | | | | | | | | | | | | | | | | | | | | | | | | | | | | | | | | | | | | | | | | | | | | | | | | | | | | | | | | | | | | | | | | | | | | | | | | | | | | | | | | | | | | | | | | | | | | | | | | | | | | | | | | | | | | | | | | | | | | | | | | | | | | | | | | | | | | | | | | | | | | | | | | | | | | | | | | | | | | | | | | | | | | | | | | | | | | | | | | | | | | | | | | | | | | | | | | | | | | | | | | | | | | | | | | | | | | | | | | | | | | | | | | | | | | | | | | | | | | | | | | | | | | | | | | | | | | | | | | | | | | | | | | | | | | | | | | | | | | | | | | | | | | | | | | | | | | | |
| | | | | | | 7-1/2 | 5 | | | 40.0 A | | | | | | | | | | | 41.0 A | | 15 | | | | | | | | | 42.0 A | | | | | | | 7-1/2 | | | | 46.0 A | 15 | | | | | | | | | | 48.3 A | | | | | | | | | | | 50.0 A | | | | | | | | | | | 52.0 A | | | | | | | | | | | 54.0 A | | | | | | | | | 15 | | 55.0 A | | | | | | 5 | | | | | 56.0 A | | | | | | | 10 | | | | 57.5 A | | | | | | | | 7-1/2 | | | 58.0 A | | | | | | | | | | | 62.0 A | 20 | | | | | | | | | | 62.1 A | | | | | | | | | | | 65.0 A | | | | | | | | | | | 68.0 A | | | | | | | | | 20 | | 72.0 A | | | | | | | | | | | 76.0 A | | | | | | | | | | | 77.0 A | | | | | | | | | | | 78.2 A | 25 | | | | | | | | | | 80.0 A | | | | | | 7-1/2 | | | | | 89.0 A | | | | | | | | | 25 | | 125 A | | | | | | | | | | | 125 A | | | | | | | | | | | 150 A | | | | | | | | | | | 150 A | | | | | | | | | | | 175 A | | | | | | | | | | | 175 A | | | | | | | | | | | 200 A | | | | | | | | | | | 200 A | | | | | | | | | | | 225 A | | | | | | | | | | | 225 A | | | | | | | | | | | 250 A | | | | | | | | | | | | | | | | | | | | | | | | | | | | | | | | | | | | | | | | | | | | | | | | | | | | | | | | | | | | | | | | | | | | | | | | | | | | | | | | | | | | | | | | | | | | | | | | | | | | | | | | | | | | | | | | | | | | | | | | | | | | | | | | | | | | | | | | | | | | | | | | | | | | | | | | | | | | | | | | | | | | | | | | | | | | | | | | | | | | | | | | | | | | | | | | | | | | | | | | | | | | | | | | | | | | | | | | | | | | | | | | | | | | | | | | | | | | | | | | | | | | | | | | | | | | | | | | | | | | | | | | | | | | | | | | | | | | | | | | | | | | | | | | | | | | | | | | | | | | | | | | | | | | | | | | | | | | | | | | | | | | | | | | | | | | | | | | | | | | | | | | | | | | | | | | | | | | | | | | | | | | | | | | | | | | | | | | | | | | | | | | | | | | | | | | | | | | | | | | | | | | | | | | | | | | |
| | | | | | | | | | | 41.0 A | | 15 | | | | | | | | | 42.0 A | | | | | | | 7-1/2 | | | | 46.0 A | 15 | | | | | | | | | | 48.3 A | | | | | | | | | | | 50.0 A | | | | | | | | | | | 52.0 A | | | | | | | | | | | 54.0 A | | | | | | | | | 15 | | 55.0 A | | | | | | 5 | | | | | 56.0 A | | | | | | | 10 | | | | 57.5 A | | | | | | | | 7-1/2 | | | 58.0 A | | | | | | | | | | | 62.0 A | 20 | | | | | | | | | | 62.1 A | | | | | | | | | | | 65.0 A | | | | | | | | | | | 68.0 A | | | | | | | | | 20 | | 72.0 A | | | | | | | | | | | 76.0 A | | | | | | | | | | | 77.0 A | | | | | | | | | | | 78.2 A | 25 | | | | | | | | | | 80.0 A | | | | | | 7-1/2 | | | | | 89.0 A | | | | | | | | | 25 | | 125 A | | | | | | | | | | | 125 A | | | | | | | | | | | 150 A | | | | | | | | | | | 150 A | | | | | | | | | | | 175 A | | | | | | | | | | | 175 A | | | | | | | | | | | 200 A | | | | | | | | | | | 200 A | | | | | | | | | | | 225 A | | | | | | | | | | | 225 A | | | | | | | | | | | 250 A | | | | | | | | | | | | | | | | | | | | | | | | | | | | | | | | | | | | | | | | | | | | | | | | | | | | | | | | | | | | | | | | | | | | | | | | | | | | | | | | | | | | | | | | | | | | | | | | | | | | | | | | | | | | | | | | | | | | | | | | | | | | | | | | | | | | | | | | | | | | | | | | | | | | | | | | | | | | | | | | | | | | | | | | | | | | | | | | | | | | | | | | | | | | | | | | | | | | | | | | | | | | | | | | | | | | | | | | | | | | | | | | | | | | | | | | | | | | | | | | | | | | | | | | | | | | | | | | | | | | | | | | | | | | | | | | | | | | | | | | | | | | | | | | | | | | | | | | | | | | | | | | | | | | | | | | | | | | | | | | | | | | | | | | | | | | | | | | | | | | | | | | | | | | | | | | | | | | | | | | | | | | | | | | | | | | | | | | | | | | | | | | | | | | | | | | | | | | | | | | | | | | | | | | | | | | | | | | | | | | | | | |
| | 15 | | | | | | | | | 42.0 A | | | | | | | 7-1/2 | | | | 46.0 A | 15 | | | | | | | | | | 48.3 A | | | | | | | | | | | 50.0 A | | | | | | | | | | | 52.0 A | | | | | | | | | | | 54.0 A | | | | | | | | | 15 | | 55.0 A | | | | | | 5 | | | | | 56.0 A | | | | | | | 10 | | | | 57.5 A | | | | | | | | 7-1/2 | | | 58.0 A | | | | | | | | | | | 62.0 A | 20 | | | | | | | | | | 62.1 A | | | | | | | | | | | 65.0 A | | | | | | | | | | | 68.0 A | | | | | | | | | 20 | | 72.0 A | | | | | | | | | | | 76.0 A | | | | | | | | | | | 77.0 A | | | | | | | | | | | 78.2 A | 25 | | | | | | | | | | 80.0 A | | | | | | 7-1/2 | | | | | 89.0 A | | | | | | | | | 25 | | 125 A | | | | | | | | | | | 125 A | | | | | | | | | | | 150 A | | | | | | | | | | | 150 A | | | | | | | | | | | 175 A | | | | | | | | | | | 175 A | | | | | | | | | | | 200 A | | | | | | | | | | | 200 A | | | | | | | | | | | 225 A | | | | | | | | | | | 225 A | | | | | | | | | | | 250 A | | | | | | | | | | | | | | | | | | | | | | | | | | | | | | | | | | | | | | | | | | | | | | | | | | | | | | | | | | | | | | | | | | | | | | | | | | | | | | | | | | | | | | | | | | | | | | | | | | | | | | | | | | | | | | | | | | | | | | | | | | | | | | | | | | | | | | | | | | | | | | | | | | | | | | | | | | | | | | | | | | | | | | | | | | | | | | | | | | | | | | | | | | | | | | | | | | | | | | | | | | | | | | | | | | | | | | | | | | | | | | | | | | | | | | | | | | | | | | | | | | | | | | | | | | | | | | | | | | | | | | | | | | | | | | | | | | | | | | | | | | | | | | | | | | | | | | | | | | | | | | | | | | | | | | | | | | | | | | | | | | | | | | | | | | | | | | | | | | | | | | | | | | | | | | | | | | | | | | | | | | | | | | | | | | | | | | | | | | | | | | | | | | | | | | | | | | | | | | | | | | | | | | | | | | | | | | | | | | | | | | | | | | | | | | | | | | |
| | | | | | | 7-1/2 | | | | 46.0 A | 15 | | | | | | | | | | 48.3 A | | | | | | | | | | | 50.0 A | | | | | | | | | | | 52.0 A | | | | | | | | | | | 54.0 A | | | | | | | | | 15 | | 55.0 A | | | | | | 5 | | | | | 56.0 A | | | | | | | 10 | | | | 57.5 A | | | | | | | | 7-1/2 | | | 58.0 A | | | | | | | | | | | 62.0 A | 20 | | | | | | | | | | 62.1 A | | | | | | | | | | | 65.0 A | | | | | | | | | | | 68.0 A | | | | | | | | | 20 | | 72.0 A | | | | | | | | | | | 76.0 A | | | | | | | | | | | 77.0 A | | | | | | | | | | | 78.2 A | 25 | | | | | | | | | | 80.0 A | | | | | | 7-1/2 | | | | | 89.0 A | | | | | | | | | 25 | | 125 A | | | | | | | | | | | 125 A | | | | | | | | | | | 150 A | | | | | | | | | | | 150 A | | | | | | | | | | | 175 A | | | | | | | | | | | 175 A | | | | | | | | | | | 200 A | | | | | | | | | | | 200 A | | | | | | | | | | | 225 A | | | | | | | | | | | 225 A | | | | | | | | | | | 250 A | | | | | | | | | | | | | | | | | | | | | | | | | | | | | | | | | | | | | | | | | | | | | | | | | | | | | | | | | | | | | | | | | | | | | | | | | | | | | | | | | | | | | | | | | | | | | | | | | | | | | | | | | | | | | | | | | | | | | | | | | | | | | | | | | | | | | | | | | | | | | | | | | | | | | | | | | | | | | | | | | | | | | | | | | | | | | | | | | | | | | | | | | | | | | | | | | | | | | | | | | | | | | | | | | | | | | | | | | | | | | | | | | | | | | | | | | | | | | | | | | | | | | | | | | | | | | | | | | | | | | | | | | | | | | | | | | | | | | | | | | | | | | | | | | | | | | | | | | | | | | | | | | | | | | | | | | | | | | | | | | | | | | | | | | | | | | | | | | | | | | | | | | | | | | | | | | | | | | | | | | | | | | | | | | | | | | | | | | | | | | | | | | | | | | | | | | | | | | | | | | | | | | | | | | | | | | | | | | | | | | | | | | | | | | | | | | | | | | | | | | | | | | |
| 15 | | | | | | | | | | 48.3 A | | | | | | | | | | | 50.0 A | | | | | | | | | | | 52.0 A | | | | | | | | | | | 54.0 A | | | | | | | | | 15 | | 55.0 A | | | | | | 5 | | | | | 56.0 A | | | | | | | 10 | | | | 57.5 A | | | | | | | | 7-1/2 | | | 58.0 A | | | | | | | | | | | 62.0 A | 20 | | | | | | | | | | 62.1 A | | | | | | | | | | | 65.0 A | | | | | | | | | | | 68.0 A | | | | | | | | | 20 | | 72.0 A | | | | | | | | | | | 76.0 A | | | | | | | | | | | 77.0 A | | | | | | | | | | | 78.2 A | 25 | | | | | | | | | | 80.0 A | | | | | | 7-1/2 | | | | | 89.0 A | | | | | | | | | 25 | | 125 A | | | | | | | | | | | 125 A | | | | | | | | | | | 150 A | | | | | | | | | | | 150 A | | | | | | | | | | | 175 A | | | | | | | | | | | 175 A | | | | | | | | | | | 200 A | | | | | | | | | | | 200 A | | | | | | | | | | | 225 A | | | | | | | | | | | 225 A | | | | | | | | | | | 250 A | | | | | | | | | | | | | | | | | | | | | | | | | | | | | | | | | | | | | | | | | | | | | | | | | | | | | | | | | | | | | | | | | | | | | | | | | | | | | | | | | | | | | | | | | | | | | | | | | | | | | | | | | | | | | | | | | | | | | | | | | | | | | | | | | | | | | | | | | | | | | | | | | | | | | | | | | | | | | | | | | | | | | | | | | | | | | | | | | | | | | | | | | | | | | | | | | | | | | | | | | | | | | | | | | | | | | | | | | | | | | | | | | | | | | | | | | | | | | | | | | | | | | | | | | | | | | | | | | | | | | | | | | | | | | | | | | | | | | | | | | | | | | | | | | | | | | | | | | | | | | | | | | | | | | | | | | | | | | | | | | | | | | | | | | | | | | | | | | | | | | | | | | | | | | | | | | | | | | | | | | | | | | | | | | | | | | | | | | | | | | | | | | | | | | | | | | | | | | | | | | | | | | | | | | | | | | | | | | | | | | | | | | | | | | | | | | | | | | | | | | | | | | | | | | | | | | | | | |
| | | | | | | | | | | 50.0 A | | | | | | | | | | | 52.0 A | | | | | | | | | | | 54.0 A | | | | | | | | | 15 | | 55.0 A | | | | | | 5 | | | | | 56.0 A | | | | | | | 10 | | | | 57.5 A | | | | | | | | 7-1/2 | | | 58.0 A | | | | | | | | | | | 62.0 A | 20 | | | | | | | | | | 62.1 A | | | | | | | | | | | 65.0 A | | | | | | | | | | | 68.0 A | | | | | | | | | 20 | | 72.0 A | | | | | | | | | | | 76.0 A | | | | | | | | | | | 77.0 A | | | | | | | | | | | 78.2 A | 25 | | | | | | | | | | 80.0 A | | | | | | 7-1/2 | | | | | 89.0 A | | | | | | | | | 25 | | 125 A | | | | | | | | | | | 125 A | | | | | | | | | | | 150 A | | | | | | | | | | | 150 A | | | | | | | | | | | 175 A | | | | | | | | | | | 175 A | | | | | | | | | | | 200 A | | | | | | | | | | | 200 A | | | | | | | | | | | 225 A | | | | | | | | | | | 225 A | | | | | | | | | | | 250 A | | | | | | | | | | | | | | | | | | | | | | | | | | | | | | | | | | | | | | | | | | | | | | | | | | | | | | | | | | | | | | | | | | | | | | | | | | | | | | | | | | | | | | | | | | | | | | | | | | | | | | | | | | | | | | | | | | | | | | | | | | | | | | | | | | | | | | | | | | | | | | | | | | | | | | | | | | | | | | | | | | | | | | | | | | | | | | | | | | | | | | | | | | | | | | | | | | | | | | | | | | | | | | | | | | | | | | | | | | | | | | | | | | | | | | | | | | | | | | | | | | | | | | | | | | | | | | | | | | | | | | | | | | | | | | | | | | | | | | | | | | | | | | | | | | | | | | | | | | | | | | | | | | | | | | | | | | | | | | | | | | | | | | | | | | | | | | | | | | | | | | | | | | | | | | | | | | | | | | | | | | | | | | | | | | | | | | | | | | | | | | | | | | | | | | | | | | | | | | | | | | | | | | | | | | | | | | | | | | | | | | | | | | | | | | | | | | | | | | | | | | | | | | | | | | | | | | | | | | | | | | | | | | | |
| | | | | | | | | | | 52.0 A | | | | | | | | | | | 54.0 A | | | | | | | | | 15 | | 55.0 A | | | | | | 5 | | | | | 56.0 A | | | | | | | 10 | | | | 57.5 A | | | | | | | | 7-1/2 | | | 58.0 A | | | | | | | | | | | 62.0 A | 20 | | | | | | | | | | 62.1 A | | | | | | | | | | | 65.0 A | | | | | | | | | | | 68.0 A | | | | | | | | | 20 | | 72.0 A | | | | | | | | | | | 76.0 A | | | | | | | | | | | 77.0 A | | | | | | | | | | | 78.2 A | 25 | | | | | | | | | | 80.0 A | | | | | | 7-1/2 | | | | | 89.0 A | | | | | | | | | 25 | | 125 A | | | | | | | | | | | 125 A | | | | | | | | | | | 150 A | | | | | | | | | | | 150 A | | | | | | | | | | | 175 A | | | | | | | | | | | 175 A | | | | | | | | | | | 200 A | | | | | | | | | | | 200 A | | | | | | | | | | | 225 A | | | | | | | | | | | 225 A | | | | | | | | | | | 250 A | | | | | | | | | | | | | | | | | | | | | | | | | | | | | | | | | | | | | | | | | | | | | | | | | | | | | | | | | | | | | | | | | | | | | | | | | | | | | | | | | | | | | | | | | | | | | | | | | | | | | | | | | | | | | | | | | | | | | | | | | | | | | | | | | | | | | | | | | | | | | | | | | | | | | | | | | | | | | | | | | | | | | | | | | | | | | | | | | | | | | | | | | | | | | | | | | | | | | | | | | | | | | | | | | | | | | | | | | | | | | | | | | | | | | | | | | | | | | | | | | | | | | | | | | | | | | | | | | | | | | | | | | | | | | | | | | | | | | | | | | | | | | | | | | | | | | | | | | | | | | | | | | | | | | | | | | | | | | | | | | | | | | | | | | | | | | | | | | | | | | | | | | | | | | | | | | | | | | | | | | | | | | | | | | | | | | | | | | | | | | | | | | | | | | | | | | | | | | | | | | | | | | | | | | | | | | | | | | | | | | | | | | | | | | | | | | | | | | | | | | | | | | | | | | | | | | | | | | | | | | | | | | | | | | | | | | | | | | | |
| | | | | | | | | | | 54.0 A | | | | | | | | | 15 | | 55.0 A | | | | | | 5 | | | | | 56.0 A | | | | | | | 10 | | | | 57.5 A | | | | | | | | 7-1/2 | | | 58.0 A | | | | | | | | | | | 62.0 A | 20 | | | | | | | | | | 62.1 A | | | | | | | | | | | 65.0 A | | | | | | | | | | | 68.0 A | | | | | | | | | 20 | | 72.0 A | | | | | | | | | | | 76.0 A | | | | | | | | | | | 77.0 A | | | | | | | | | | | 78.2 A | 25 | | | | | | | | | | 80.0 A | | | | | | 7-1/2 | | | | | 89.0 A | | | | | | | | | 25 | | 125 A | | | | | | | | | | | 125 A | | | | | | | | | | | 150 A | | | | | | | | | | | 150 A | | | | | | | | | | | 175 A | | | | | | | | | | | 175 A | | | | | | | | | | | 200 A | | | | | | | | | | | 200 A | | | | | | | | | | | 225 A | | | | | | | | | | | 225 A | | | | | | | | | | | 250 A | | | | | | | | | | | | | | | | | | | | | | | | | | | | | | | | | | | | | | | | | | | | | | | | | | | | | | | | | | | | | | | | | | | | | | | | | | | | | | | | | | | | | | | | | | | | | | | | | | | | | | | | | | | | | | | | | | | | | | | | | | | | | | | | | | | | | | | | | | | | | | | | | | | | | | | | | | | | | | | | | | | | | | | | | | | | | | | | | | | | | | | | | | | | | | | | | | | | | | | | | | | | | | | | | | | | | | | | | | | | | | | | | | | | | | | | | | | | | | | | | | | | | | | | | | | | | | | | | | | | | | | | | | | | | | | | | | | | | | | | | | | | | | | | | | | | | | | | | | | | | | | | | | | | | | | | | | | | | | | | | | | | | | | | | | | | | | | | | | | | | | | | | | | | | | | | | | | | | | | | | | | | | | | | | | | | | | | | | | | | | | | | | | | | | | | | | | | | | | | | | | | | | | | | | | | | | | | | | | | | | | | | | | | | | | | | | | | | | | | | | | | | | | | | | | | | | | | | | | | | | | | | | | | | | | | | | | | | | | | | | | | | | | | | | |
| | | | | | | | | 15 | | 55.0 A | | | | | | 5 | | | | | 56.0 A | | | | | | | 10 | | | | 57.5 A | | | | | | | | 7-1/2 | | | 58.0 A | | | | | | | | | | | 62.0 A | 20 | | | | | | | | | | 62.1 A | | | | | | | | | | | 65.0 A | | | | | | | | | | | 68.0 A | | | | | | | | | 20 | | 72.0 A | | | | | | | | | | | 76.0 A | | | | | | | | | | | 77.0 A | | | | | | | | | | | 78.2 A | 25 | | | | | | | | | | 80.0 A | | | | | | 7-1/2 | | | | | 89.0 A | | | | | | | | | 25 | | 125 A | | | | | | | | | | | 125 A | | | | | | | | | | | 150 A | | | | | | | | | | | 150 A | | | | | | | | | | | 175 A | | | | | | | | | | | 175 A | | | | | | | | | | | 200 A | | | | | | | | | | | 200 A | | | | | | | | | | | 225 A | | | | | | | | | | | 225 A | | | | | | | | | | | 250 A | | | | | | | | | | | | | | | | | | | | | | | | | | | | | | | | | | | | | | | | | | | | | | | | | | | | | | | | | | | | | | | | | | | | | | | | | | | | | | | | | | | | | | | | | | | | | | | | | | | | | | | | | | | | | | | | | | | | | | | | | | | | | | | | | | | | | | | | | | | | | | | | | | | | | | | | | | | | | | | | | | | | | | | | | | | | | | | | | | | | | | | | | | | | | | | | | | | | | | | | | | | | | | | | | | | | | | | | | | | | | | | | | | | | | | | | | | | | | | | | | | | | | | | | | | | | | | | | | | | | | | | | | | | | | | | | | | | | | | | | | | | | | | | | | | | | | | | | | | | | | | | | | | | | | | | | | | | | | | | | | | | | | | | | | | | | | | | | | | | | | | | | | | | | | | | | | | | | | | | | | | | | | | | | | | | | | | | | | | | | | | | | | | | | | | | | | | | | | | | | | | | | | | | | | | | | | | | | | | | | | | | | | | | | | | | | | | | | | | | | | | | | | | | | | | | | | | | | | | | | | | | | | | | | | | | | | | | | | | | | | | | | | | | | | | | | | | | | | | | | |
| | | | | | 5 | | | | | 56.0 A | | | | | | | 10 | | | | 57.5 A | | | | | | | | 7-1/2 | | | 58.0 A | | | | | | | | | | | 62.0 A | 20 | | | | | | | | | | 62.1 A | | | | | | | | | | | 65.0 A | | | | | | | | | | | 68.0 A | | | | | | | | | 20 | | 72.0 A | | | | | | | | | | | 76.0 A | | | | | | | | | | | 77.0 A | | | | | | | | | | | 78.2 A | 25 | | | | | | | | | | 80.0 A | | | | | | 7-1/2 | | | | | 89.0 A | | | | | | | | | 25 | | 125 A | | | | | | | | | | | 125 A | | | | | | | | | | | 150 A | | | | | | | | | | | 150 A | | | | | | | | | | | 175 A | | | | | | | | | | | 175 A | | | | | | | | | | | 200 A | | | | | | | | | | | 200 A | | | | | | | | | | | 225 A | | | | | | | | | | | 225 A | | | | | | | | | | | 250 A | | | | | | | | | | | | | | | | | | | | | | | | | | | | | | | | | | | | | | | | | | | | | | | | | | | | | | | | | | | | | | | | | | | | | | | | | | | | | | | | | | | | | | | | | | | | | | | | | | | | | | | | | | | | | | | | | | | | | | | | | | | | | | | | | | | | | | | | | | | | | | | | | | | | | | | | | | | | | | | | | | | | | | | | | | | | | | | | | | | | | | | | | | | | | | | | | | | | | | | | | | | | | | | | | | | | | | | | | | | | | | | | | | | | | | | | | | | | | | | | | | | | | | | | | | | | | | | | | | | | | | | | | | | | | | | | | | | | | | | | | | | | | | | | | | | | | | | | | | | | | | | | | | | | | | | | | | | | | | | | | | | | | | | | | | | | | | | | | | | | | | | | | | | | | | | | | | | | | | | | | | | | | | | | | | | | | | | | | | | | | | | | | | | | | | | | | | | | | | | | | | | | | | | | | | | | | | | | | | | | | | | | | | | | | | | | | | | | | | | | | | | | | | | | | | | | | | | | | | | | | | | | | | | | | | | | | | | | | | | | | | | | | | | | | | | | | | | | | | | | | | | | | | | | | | | |
| | | | | | | 10 | | | | 57.5 A | | | | | | | | 7-1/2 | | | 58.0 A | | | | | | | | | | | 62.0 A | 20 | | | | | | | | | | 62.1 A | | | | | | | | | | | 65.0 A | | | | | | | | | | | 68.0 A | | | | | | | | | 20 | | 72.0 A | | | | | | | | | | | 76.0 A | | | | | | | | | | | 77.0 A | | | | | | | | | | | 78.2 A | 25 | | | | | | | | | | 80.0 A | | | | | | 7-1/2 | | | | | 89.0 A | | | | | | | | | 25 | | 125 A | | | | | | | | | | | 125 A | | | | | | | | | | | 150 A | | | | | | | | | | | 150 A | | | | | | | | | | | 175 A | | | | | | | | | | | 175 A | | | | | | | | | | | 200 A | | | | | | | | | | | 200 A | | | | | | | | | | | 225 A | | | | | | | | | | | 225 A | | | | | | | | | | | 250 A | | | | | | | | | | | | | | | | | | | | | | | | | | | | | | | | | | | | | | | | | | | | | | | | | | | | | | | | | | | | | | | | | | | | | | | | | | | | | | | | | | | | | | | | | | | | | | | | | | | | | | | | | | | | | | | | | | | | | | | | | | | | | | | | | | | | | | | | | | | | | | | | | | | | | | | | | | | | | | | | | | | | | | | | | | | | | | | | | | | | | | | | | | | | | | | | | | | | | | | | | | | | | | | | | | | | | | | | | | | | | | | | | | | | | | | | | | | | | | | | | | | | | | | | | | | | | | | | | | | | | | | | | | | | | | | | | | | | | | | | | | | | | | | | | | | | | | | | | | | | | | | | | | | | | | | | | | | | | | | | | | | | | | | | | | | | | | | | | | | | | | | | | | | | | | | | | | | | | | | | | | | | | | | | | | | | | | | | | | | | | | | | | | | | | | | | | | | | | | | | | | | | | | | | | | | | | | | | | | | | | | | | | | | | | | | | | | | | | | | | | | | | | | | | | | | | | | | | | | | | | | | | | | | | | | | | | | | | | | | | | | | | | | | | | | | | | | | | | | | | | | | | | | | | | | | | | | | | | | | | | | |
| | | | | | | | 7-1/2 | | | 58.0 A | | | | | | | | | | | 62.0 A | 20 | | | | | | | | | | 62.1 A | | | | | | | | | | | 65.0 A | | | | | | | | | | | 68.0 A | | | | | | | | | 20 | | 72.0 A | | | | | | | | | | | 76.0 A | | | | | | | | | | | 77.0 A | | | | | | | | | | | 78.2 A | 25 | | | | | | | | | | 80.0 A | | | | | | 7-1/2 | | | | | 89.0 A | | | | | | | | | 25 | | 125 A | | | | | | | | | | | 125 A | | | | | | | | | | | 150 A | | | | | | | | | | | 150 A | | | | | | | | | | | 175 A | | | | | | | | | | | 175 A | | | | | | | | | | | 200 A | | | | | | | | | | | 200 A | | | | | | | | | | | 225 A | | | | | | | | | | | 225 A | | | | | | | | | | | 250 A | | | | | | | | | | | | | | | | | | | | | | | | | | | | | | | | | | | | | | | | | | | | | | | | | | | | | | | | | | | | | | | | | | | | | | | | | | | | | | | | | | | | | | | | | | | | | | | | | | | | | | | | | | | | | | | | | | | | | | | | | | | | | | | | | | | | | | | | | | | | | | | | | | | | | | | | | | | | | | | | | | | | | | | | | | | | | | | | | | | | | | | | | | | | | | | | | | | | | | | | | | | | | | | | | | | | | | | | | | | | | | | | | | | | | | | | | | | | | | | | | | | | | | | | | | | | | | | | | | | | | | | | | | | | | | | | | | | | | | | | | | | | | | | | | | | | | | | | | | | | | | | | | | | | | | | | | | | | | | | | | | | | | | | | | | | | | | | | | | | | | | | | | | | | | | | | | | | | | | | | | | | | | | | | | | | | | | | | | | | | | | | | | | | | | | | | | | | | | | | | | | | | | | | | | | | | | | | | | | | | | | | | | | | | | | | | | | | | | | | | | | | | | | | | | | | | | | | | | | | | | | | | | | | | | | | | | | | | | | | | | | | | | | | | | | | | | | | | | | | | | | | | | | | | | | | | | | | | | | | | | | | | | | | | | | | | | |
| | | | | | | | | | | 62.0 A | 20 | | | | | | | | | | 62.1 A | | | | | | | | | | | 65.0 A | | | | | | | | | | | 68.0 A | | | | | | | | | 20 | | 72.0 A | | | | | | | | | | | 76.0 A | | | | | | | | | | | 77.0 A | | | | | | | | | | | 78.2 A | 25 | | | | | | | | | | 80.0 A | | | | | | 7-1/2 | | | | | 89.0 A | | | | | | | | | 25 | | 125 A | | | | | | | | | | | 125 A | | | | | | | | | | | 150 A | | | | | | | | | | | 150 A | | | | | | | | | | | 175 A | | | | | | | | | | | 175 A | | | | | | | | | | | 200 A | | | | | | | | | | | 200 A | | | | | | | | | | | 225 A | | | | | | | | | | | 225 A | | | | | | | | | | | 250 A | | | | | | | | | | | | | | | | | | | | | | | | | | | | | | | | | | | | | | | | | | | | | | | | | | | | | | | | | | | | | | | | | | | | | | | | | | | | | | | | | | | | | | | | | | | | | | | | | | | | | | | | | | | | | | | | | | | | | | | | | | | | | | | | | | | | | | | | | | | | | | | | | | | | | | | | | | | | | | | | | | | | | | | | | | | | | | | | | | | | | | | | | | | | | | | | | | | | | | | | | | | | | | | | | | | | | | | | | | | | | | | | | | | | | | | | | | | | | | | | | | | | | | | | | | | | | | | | | | | | | | | | | | | | | | | | | | | | | | | | | | | | | | | | | | | | | | | | | | | | | | | | | | | | | | | | | | | | | | | | | | | | | | | | | | | | | | | | | | | | | | | | | | | | | | | | | | | | | | | | | | | | | | | | | | | | | | | | | | | | | | | | | | | | | | | | | | | | | | | | | | | | | | | | | | | | | | | | | | | | | | | | | | | | | | | | | | | | | | | | | | | | | | | | | | | | | | | | | | | | | | | | | | | | | | | | | | | | | | | | | | | | | | | | | | | | | | | | | | | | | | | | | | | | | | | | | | | | | | | | | | | | | | | | | | | | | | | | | | | | | | | | |
| 20 | | | | | | | | | | 62.1 A | | | | | | | | | | | 65.0 A | | | | | | | | | | | 68.0 A | | | | | | | | | 20 | | 72.0 A | | | | | | | | | | | 76.0 A | | | | | | | | | | | 77.0 A | | | | | | | | | | | 78.2 A | 25 | | | | | | | | | | 80.0 A | | | | | | 7-1/2 | | | | | 89.0 A | | | | | | | | | 25 | | 125 A | | | | | | | | | | | 125 A | | | | | | | | | | | 150 A | | | | | | | | | | | 150 A | | | | | | | | | | | 175 A | | | | | | | | | | | 175 A | | | | | | | | | | | 200 A | | | | | | | | | | | 200 A | | | | | | | | | | | 225 A | | | | | | | | | | | 225 A | | | | | | | | | | | 250 A | | | | | | | | | | | | | | | | | | | | | | | | | | | | | | | | | | | | | | | | | | | | | | | | | | | | | | | | | | | | | | | | | | | | | | | | | | | | | | | | | | | | | | | | | | | | | | | | | | | | | | | | | | | | | | | | | | | | | | | | | | | | | | | | | | | | | | | | | | | | | | | | | | | | | | | | | | | | | | | | | | | | | | | | | | | | | | | | | | | | | | | | | | | | | | | | | | | | | | | | | | | | | | | | | | | | | | | | | | | | | | | | | | | | | | | | | | | | | | | | | | | | | | | | | | | | | | | | | | | | | | | | | | | | | | | | | | | | | | | | | | | | | | | | | | | | | | | | | | | | | | | | | | | | | | | | | | | | | | | | | | | | | | | | | | | | | | | | | | | | | | | | | | | | | | | | | | | | | | | | | | | | | | | | | | | | | | | | | | | | | | | | | | | | | | | | | | | | | | | | | | | | | | | | | | | | | | | | | | | | | | | | | | | | | | | | | | | | | | | | | | | | | | | | | | | | | | | | | | | | | | | | | | | | | | | | | | | | | | | | | | | | | | | | | | | | | | | | | | | | | | | | | | | | | | | | | | | | | | | | | | | | | | | | | | | | | | | | | | | | | | | | | | | | | | | | | | | |
| | | | | | | | | | | 65.0 A | | | | | | | | | | | 68.0 A | | | | | | | | | 20 | | 72.0 A | | | | | | | | | | | 76.0 A | | | | | | | | | | | 77.0 A | | | | | | | | | | | 78.2 A | 25 | | | | | | | | | | 80.0 A | | | | | | 7-1/2 | | | | | 89.0 A | | | | | | | | | 25 | | 125 A | | | | | | | | | | | 125 A | | | | | | | | | | | 150 A | | | | | | | | | | | 150 A | | | | | | | | | | | 175 A | | | | | | | | | | | 175 A | | | | | | | | | | | 200 A | | | | | | | | | | | 200 A | | | | | | | | | | | 225 A | | | | | | | | | | | 225 A | | | | | | | | | | | 250 A | | | | | | | | | | | | | | | | | | | | | | | | | | | | | | | | | | | | | | | | | | | | | | | | | | | | | | | | | | | | | | | | | | | | | | | | | | | | | | | | | | | | | | | | | | | | | | | | | | | | | | | | | | | | | | | | | | | | | | | | | | | | | | | | | | | | | | | | | | | | | | | | | | | | | | | | | | | | | | | | | | | | | | | | | | | | | | | | | | | | | | | | | | | | | | | | | | | | | | | | | | | | | | | | | | | | | | | | | | | | | | | | | | | | | | | | | | | | | | | | | | | | | | | | | | | | | | | | | | | | | | | | | | | | | | | | | | | | | | | | | | | | | | | | | | | | | | | | | | | | | | | | | | | | | | | | | | | | | | | | | | | | | | | | | | | | | | | | | | | | | | | | | | | | | | | | | | | | | | | | | | | | | | | | | | | | | | | | | | | | | | | | | | | | | | | | | | | | | | | | | | | | | | | | | | | | | | | | | | | | | | | | | | | | | | | | | | | | | | | | | | | | | | | | | | | | | | | | | | | | | | | | | | | | | | | | | | | | | | | | | | | | | | | | | | | | | | | | | | | | | | | | | | | | | | | | | | | | | | | | | | | | | | | | | | | | | | | | | | | | | | | | | | | | | | | | | | | | | | | | | | | | | | |
| | | | | | | | | | | 68.0 A | | | | | | | | | 20 | | 72.0 A | | | | | | | | | | | 76.0 A | | | | | | | | | | | 77.0 A | | | | | | | | | | | 78.2 A | 25 | | | | | | | | | | 80.0 A | | | | | | 7-1/2 | | | | | 89.0 A | | | | | | | | | 25 | | 125 A | | | | | | | | | | | 125 A | | | | | | | | | | | 150 A | | | | | | | | | | | 150 A | | | | | | | | | | | 175 A | | | | | | | | | | | 175 A | | | | | | | | | | | 200 A | | | | | | | | | | | 200 A | | | | | | | | | | | 225 A | | | | | | | | | | | 225 A | | | | | | | | | | | 250 A | | | | | | | | | | | | | | | | | | | | | | | | | | | | | | | | | | | | | | | | | | | | | | | | | | | | | | | | | | | | | | | | | | | | | | | | | | | | | | | | | | | | | | | | | | | | | | | | | | | | | | | | | | | | | | | | | | | | | | | | | | | | | | | | | | | | | | | | | | | | | | | | | | | | | | | | | | | | | | | | | | | | | | | | | | | | | | | | | | | | | | | | | | | | | | | | | | | | | | | | | | | | | | | | | | | | | | | | | | | | | | | | | | | | | | | | | | | | | | | | | | | | | | | | | | | | | | | | | | | | | | | | | | | | | | | | | | | | | | | | | | | | | | | | | | | | | | | | | | | | | | | | | | | | | | | | | | | | | | | | | | | | | | | | | | | | | | | | | | | | | | | | | | | | | | | | | | | | | | | | | | | | | | | | | | | | | | | | | | | | | | | | | | | | | | | | | | | | | | | | | | | | | | | | | | | | | | | | | | | | | | | | | | | | | | | | | | | | | | | | | | | | | | | | | | | | | | | | | | | | | | | | | | | | | | | | | | | | | | | | | | | | | | | | | | | | | | | | | | | | | | | | | | | | | | | | | | | | | | | | | | | | | | | | | | | | | | | | | | | | | | | | | | | | | | | | | | | | | | | | | | | | | | | | | | | | | | | | | |
| | | | | | | | | 20 | | 72.0 A | | | | | | | | | | | 76.0 A | | | | | | | | | | | 77.0 A | | | | | | | | | | | 78.2 A | 25 | | | | | | | | | | 80.0 A | | | | | | 7-1/2 | | | | | 89.0 A | | | | | | | | | 25 | | 125 A | | | | | | | | | | | 125 A | | | | | | | | | | | 150 A | | | | | | | | | | | 150 A | | | | | | | | | | | 175 A | | | | | | | | | | | 175 A | | | | | | | | | | | 200 A | | | | | | | | | | | 200 A | | | | | | | | | | | 225 A | | | | | | | | | | | 225 A | | | | | | | | | | | 250 A | | | | | | | | | | | | | | | | | | | | | | | | | | | | | | | | | | | | | | | | | | | | | | | | | | | | | | | | | | | | | | | | | | | | | | | | | | | | | | | | | | | | | | | | | | | | | | | | | | | | | | | | | | | | | | | | | | | | | | | | | | | | | | | | | | | | | | | | | | | | | | | | | | | | | | | | | | | | | | | | | | | | | | | | | | | | | | | | | | | | | | | | | | | | | | | | | | | | | | | | | | | | | | | | | | | | | | | | | | | | | | | | | | | | | | | | | | | | | | | | | | | | | | | | | | | | | | | | | | | | | | | | | | | | | | | | | | | | | | | | | | | | | | | | | | | | | | | | | | | | | | | | | | | | | | | | | | | | | | | | | | | | | | | | | | | | | | | | | | | | | | | | | | | | | | | | | | | | | | | | | | | | | | | | | | | | | | | | | | | | | | | | | | | | | | | | | | | | | | | | | | | | | | | | | | | | | | | | | | | | | | | | | | | | | | | | | | | | | | | | | | | | | | | | | | | | | | | | | | | | | | | | | | | | | | | | | | | | | | | | | | | | | | | | | | | | | | | | | | | | | | | | | | | | | | | | | | | | | | | | | | | | | | | | | | | | | | | | | | | | | | | | | | | | | | | | | | | | | | | | | | | | | | | | | | | | | | | | | | | | | | | | | | | | |
| | | | | | | | | | | 76.0 A | | | | | | | | | | | 77.0 A | | | | | | | | | | | 78.2 A | 25 | | | | | | | | | | 80.0 A | | | | | | 7-1/2 | | | | | 89.0 A | | | | | | | | | 25 | | 125 A | | | | | | | | | | | 125 A | | | | | | | | | | | 150 A | | | | | | | | | | | 150 A | | | | | | | | | | | 175 A | | | | | | | | | | | 175 A | | | | | | | | | | | 200 A | | | | | | | | | | | 200 A | | | | | | | | | | | 225 A | | | | | | | | | | | 225 A | | | | | | | | | | | 250 A | | | | | | | | | | | | | | | | | | | | | | | | | | | | | | | | | | | | | | | | | | | | | | | | | | | | | | | | | | | | | | | | | | | | | | | | | | | | | | | | | | | | | | | | | | | | | | | | | | | | | | | | | | | | | | | | | | | | | | | | | | | | | | | | | | | | | | | | | | | | | | | | | | | | | | | | | | | | | | | | | | | | | | | | | | | | | | | | | | | | | | | | | | | | | | | | | | | | | | | | | | | | | | | | | | | | | | | | | | | | | | | | | | | | | | | | | | | | | | | | | | | | | | | | | | | | | | | | | | | | | | | | | | | | | | | | | | | | | | | | | | | | | | | | | | | | | | | | | | | | | | | | | | | | | | | | | | | | | | | | | | | | | | | | | | | | | | | | | | | | | | | | | | | | | | | | | | | | | | | | | | | | | | | | | | | | | | | | | | | | | | | | | | | | | | | | | | | | | | | | | | | | | | | | | | | | | | | | | | | | | | | | | | | | | | | | | | | | | | | | | | | | | | | | | | | | | | | | | | | | | | | | | | | | | | | | | | | | | | | | | | | | | | | | | | | | | | | | | | | | | | | | | | | | | | | | | | | | | | | | | | | | | | | | | | | | | | | | | | | | | | | | | | | | | | | | | | | | | | | | | | | | | | | | | | | | | | | | | | | | | | | | | | | | | | | | | | | | | | | |
| | | | | | | | | | | 77.0 A | | | | | | | | | | | 78.2 A | 25 | | | | | | | | | | 80.0 A | | | | | | 7-1/2 | | | | | 89.0 A | | | | | | | | | 25 | | 125 A | | | | | | | | | | | 125 A | | | | | | | | | | | 150 A | | | | | | | | | | | 150 A | | | | | | | | | | | 175 A | | | | | | | | | | | 175 A | | | | | | | | | | | 200 A | | | | | | | | | | | 200 A | | | | | | | | | | | 225 A | | | | | | | | | | | 225 A | | | | | | | | | | | 250 A | | | | | | | | | | | | | | | | | | | | | | | | | | | | | | | | | | | | | | | | | | | | | | | | | | | | | | | | | | | | | | | | | | | | | | | | | | | | | | | | | | | | | | | | | | | | | | | | | | | | | | | | | | | | | | | | | | | | | | | | | | | | | | | | | | | | | | | | | | | | | | | | | | | | | | | | | | | | | | | | | | | | | | | | | | | | | | | | | | | | | | | | | | | | | | | | | | | | | | | | | | | | | | | | | | | | | | | | | | | | | | | | | | | | | | | | | | | | | | | | | | | | | | | | | | | | | | | | | | | | | | | | | | | | | | | | | | | | | | | | | | | | | | | | | | | | | | | | | | | | | | | | | | | | | | | | | | | | | | | | | | | | | | | | | | | | | | | | | | | | | | | | | | | | | | | | | | | | | | | | | | | | | | | | | | | | | | | | | | | | | | | | | | | | | | | | | | | | | | | | | | | | | | | | | | | | | | | | | | | | | | | | | | | | | | | | | | | | | | | | | | | | | | | | | | | | | | | | | | | | | | | | | | | | | | | | | | | | | | | | | | | | | | | | | | | | | | | | | | | | | | | | | | | | | | | | | | | | | | | | | | | | | | | | | | | | | | | | | | | | | | | | | | | | | | | | | | | | | | | | | | | | | | | | | | | | | | | | | | | | | | | | | | | | | | | | | | | | | | | | | | | | | | | | | | |
| | | | | | | | | | | 78.2 A | 25 | | | | | | | | | | 80.0 A | | | | | | 7-1/2 | | | | | 89.0 A | | | | | | | | | 25 | | 125 A | | | | | | | | | | | 125 A | | | | | | | | | | | 150 A | | | | | | | | | | | 150 A | | | | | | | | | | | 175 A | | | | | | | | | | | 175 A | | | | | | | | | | | 200 A | | | | | | | | | | | 200 A | | | | | | | | | | | 225 A | | | | | | | | | | | 225 A | | | | | | | | | | | 250 A | | | | | | | | | | | | | | | | | | | | | | | | | | | | | | | | | | | | | | | | | | | | | | | | | | | | | | | | | | | | | | | | | | | | | | | | | | | | | | | | | | | | | | | | | | | | | | | | | | | | | | | | | | | | | | | | | | | | | | | | | | | | | | | | | | | | | | | | | | | | | | | | | | | | | | | | | | | | | | | | | | | | | | | | | | | | | | | | | | | | | | | | | | | | | | | | | | | | | | | | | | | | | | | | | | | | | | | | | | | | | | | | | | | | | | | | | | | | | | | | | | | | | | | | | | | | | | | | | | | | | | | | | | | | | | | | | | | | | | | | | | | | | | | | | | | | | | | | | | | | | | | | | | | | | | | | | | | | | | | | | | | | | | | | | | | | | | | | | | | | | | | | | | | | | | | | | | | | | | | | | | | | | | | | | | | | | | | | | | | | | | | | | | | | | | | | | | | | | | | | | | | | | | | | | | | | | | | | | | | | | | | | | | | | | | | | | | | | | | | | | | | | | | | | | | | | | | | | | | | | | | | | | | | | | | | | | | | | | | | | | | | | | | | | | | | | | | | | | | | | | | | | | | | | | | | | | | | | | | | | | | | | | | | | | | | | | | | | | | | | | | | | | | | | | | | | | | | | | | | | | | | | | | | | | | | | | | | | | | | | | | | | | | | | | | | | | | | | | | | | | | | | | | | | | | | | | | | | | | | | | |
| 25 | | | | | | | | | | 80.0 A | | | | | | 7-1/2 | | | | | 89.0 A | | | | | | | | | 25 | | 125 A | | | | | | | | | | | 125 A | | | | | | | | | | | 150 A | | | | | | | | | | | 150 A | | | | | | | | | | | 175 A | | | | | | | | | | | 175 A | | | | | | | | | | | 200 A | | | | | | | | | | | 200 A | | | | | | | | | | | 225 A | | | | | | | | | | | 225 A | | | | | | | | | | | 250 A | | | | | | | | | | | | | | | | | | | | | | | | | | | | | | | | | | | | | | | | | | | | | | | | | | | | | | | | | | | | | | | | | | | | | | | | | | | | | | | | | | | | | | | | | | | | | | | | | | | | | | | | | | | | | | | | | | | | | | | | | | | | | | | | | | | | | | | | | | | | | | | | | | | | | | | | | | | | | | | | | | | | | | | | | | | | | | | | | | | | | | | | | | | | | | | | | | | | | | | | | | | | | | | | | | | | | | | | | | | | | | | | | | | | | | | | | | | | | | | | | | | | | | | | | | | | | | | | | | | | | | | | | | | | | | | | | | | | | | | | | | | | | | | | | | | | | | | | | | | | | | | | | | | | | | | | | | | | | | | | | | | | | | | | | | | | | | | | | | | | | | | | | | | | | | | | | | | | | | | | | | | | | | | | | | | | | | | | | | | | | | | | | | | | | | | | | | | | | | | | | | | | | | | | | | | | | | | | | | | | | | | | | | | | | | | | | | | | | | | | | | | | | | | | | | | | | | | | | | | | | | | | | | | | | | | | | | | | | | | | | | | | | | | | | | | | | | | | | | | | | | | | | | | | | | | | | | | | | | | | | | | | | | | | | | | | | | | | | | | | | | | | | | | | | | | | | | | | | | | | | | | | | | | | | | | | | | | | | | | | | | | | | | | | | | | | | | | | | | | | | | | | | | | | | | | | | | | | | | | | | | | | | | | | | | | | |
| | | | | | 7-1/2 | | | | | 89.0 A | | | | | | | | | 25 | | 125 A | | | | | | | | | | | 125 A | | | | | | | | | | | 150 A | | | | | | | | | | | 150 A | | | | | | | | | | | 175 A | | | | | | | | | | | 175 A | | | | | | | | | | | 200 A | | | | | | | | | | | 200 A | | | | | | | | | | | 225 A | | | | | | | | | | | 225 A | | | | | | | | | | | 250 A | | | | | | | | | | | | | | | | | | | | | | | | | | | | | | | | | | | | | | | | | | | | | | | | | | | | | | | | | | | | | | | | | | | | | | | | | | | | | | | | | | | | | | | | | | | | | | | | | | | | | | | | | | | | | | | | | | | | | | | | | | | | | | | | | | | | | | | | | | | | | | | | | | | | | | | | | | | | | | | | | | | | | | | | | | | | | | | | | | | | | | | | | | | | | | | | | | | | | | | | | | | | | | | | | | | | | | | | | | | | | | | | | | | | | | | | | | | | | | | | | | | | | | | | | | | | | | | | | | | | | | | | | | | | | | | | | | | | | | | | | | | | | | | | | | | | | | | | | | | | | | | | | | | | | | | | | | | | | | | | | | | | | | | | | | | | | | | | | | | | | | | | | | | | | | | | | | | | | | | | | | | | | | | | | | | | | | | | | | | | | | | | | | | | | | | | | | | | | | | | | | | | | | | | | | | | | | | | | | | | | | | | | | | | | | | | | | | | | | | | | | | | | | | | | | | | | | | | | | | | | | | | | | | | | | | | | | | | | | | | | | | | | | | | | | | | | | | | | | | | | | | | | | | | | | | | | | | | | | | | | | | | | | | | | | | | | | | | | | | | | | | | | | | | | | | | | | | | | | | | | | | | | | | | | | | | | | | | | | | | | | | | | | | | | | | | | | | | | | | | | | | | | | | | | | | | | | | | | | | | | | | | | | | | | | | | | | | | | | | | | | | |
| | | | | | | | | 25 | | 125 A | | | | | | | | | | | 125 A | | | | | | | | | | | 150 A | | | | | | | | | | | 150 A | | | | | | | | | | | 175 A | | | | | | | | | | | 175 A | | | | | | | | | | | 200 A | | | | | | | | | | | 200 A | | | | | | | | | | | 225 A | | | | | | | | | | | 225 A | | | | | | | | | | | 250 A | | | | | | | | | | | | | | | | | | | | | | | | | | | | | | | | | | | | | | | | | | | | | | | | | | | | | | | | | | | | | | | | | | | | | | | | | | | | | | | | | | | | | | | | | | | | | | | | | | | | | | | | | | | | | | | | | | | | | | | | | | | | | | | | | | | | | | | | | | | | | | | | | | | | | | | | | | | | | | | | | | | | | | | | | | | | | | | | | | | | | | | | | | | | | | | | | | | | | | | | | | | | | | | | | | | | | | | | | | | | | | | | | | | | | | | | | | | | | | | | | | | | | | | | | | | | | | | | | | | | | | | | | | | | | | | | | | | | | | | | | | | | | | | | | | | | | | | | | | | | | | | | | | | | | | | | | | | | | | | | | | | | | | | | | | | | | | | | | | | | | | | | | | | | | | | | | | | | | | | | | | | | | | | | | | | | | | | | | | | | | | | | | | | | | | | | | | | | | | | | | | | | | | | | | | | | | | | | | | | | | | | | | | | | | | | | | | | | | | | | | | | | | | | | | | | | | | | | | | | | | | | | | | | | | | | | | | | | | | | | | | | | | | | | | | | | | | | | | | | | | | | | | | | | | | | | | | | | | | | | | | | | | | | | | | | | | | | | | | | | | | | | | | | | | | | | | | | | | | | | | | | | | | | | | | | | | | | | | | | | | | | | | | | | | | | | | | | | | | | | | | | | | | | | | | | | | | | | | | | | | | | | | | | | | | | | | | | | | | | | | | | | | | | | | | | | | | |
| | | | | | | | | | | 125 A | | | | | | | | | | | 150 A | | | | | | | | | | | 150 A | | | | | | | | | | | 175 A | | | | | | | | | | | 175 A | | | | | | | | | | | 200 A | | | | | | | | | | | 200 A | | | | | | | | | | | 225 A | | | | | | | | | | | 225 A | | | | | | | | | | | 250 A | | | | | | | | | | | | | | | | | | | | | | | | | | | | | | | | | | | | | | | | | | | | | | | | | | | | | | | | | | | | | | | | | | | | | | | | | | | | | | | | | | | | | | | | | | | | | | | | | | | | | | | | | | | | | | | | | | | | | | | | | | | | | | | | | | | | | | | | | | | | | | | | | | | | | | | | | | | | | | | | | | | | | | | | | | | | | | | | | | | | | | | | | | | | | | | | | | | | | | | | | | | | | | | | | | | | | | | | | | | | | | | | | | | | | | | | | | | | | | | | | | | | | | | | | | | | | | | | | | | | | | | | | | | | | | | | | | | | | | | | | | | | | | | | | | | | | | | | | | | | | | | | | | | | | | | | | | | | | | | | | | | | | | | | | | | | | | | | | | | | | | | | | | | | | | | | | | | | | | | | | | | | | | | | | | | | | | | | | | | | | | | | | | | | | | | | | | | | | | | | | | | | | | | | | | | | | | | | | | | | | | | | | | | | | | | | | | | | | | | | | | | | | | | | | | | | | | | | | | | | | | | | | | | | | | | | | | | | | | | | | | | | | | | | | | | | | | | | | | | | | | | | | | | | | | | | | | | | | | | | | | | | | | | | | | | | | | | | | | | | | | | | | | | | | | | | | | | | | | | | | | | | | | | | | | | | | | | | | | | | | | | | | | | | | | | | | | | | | | | | | | | | | | | | | | | | | | | | | | | | | | | | | | | | | | | | | | | | | | | | | | | | | | | | | | | | | | | | | | | | | | | | | |
| | | | | | | | | | | 150 A | | | | | | | | | | | 150 A | | | | | | | | | | | 175 A | | | | | | | | | | | 175 A | | | | | | | | | | | 200 A | | | | | | | | | | | 200 A | | | | | | | | | | | 225 A | | | | | | | | | | | 225 A | | | | | | | | | | | 250 A | | | | | | | | | | | | | | | | | | | | | | | | | | | | | | | | | | | | | | | | | | | | | | | | | | | | | | | | | | | | | | | | | | | | | | | | | | | | | | | | | | | | | | | | | | | | | | | | | | | | | | | | | | | | | | | | | | | | | | | | | | | | | | | | | | | | | | | | | | | | | | | | | | | | | | | | | | | | | | | | | | | | | | | | | | | | | | | | | | | | | | | | | | | | | | | | | | | | | | | | | | | | | | | | | | | | | | | | | | | | | | | | | | | | | | | | | | | | | | | | | | | | | | | | | | | | | | | | | | | | | | | | | | | | | | | | | | | | | | | | | | | | | | | | | | | | | | | | | | | | | | | | | | | | | | | | | | | | | | | | | | | | | | | | | | | | | | | | | | | | | | | | | | | | | | | | | | | | | | | | | | | | | | | | | | | | | | | | | | | | | | | | | | | | | | | | | | | | | | | | | | | | | | | | | | | | | | | | | | | | | | | | | | | | | | | | | | | | | | | | | | | | | | | | | | | | | | | | | | | | | | | | | | | | | | | | | | | | | | | | | | | | | | | | | | | | | | | | | | | | | | | | | | | | | | | | | | | | | | | | | | | | | | | | | | | | | | | | | | | | | | | | | | | | | | | | | | | | | | | | | | | | | | | | | | | | | | | | | | | | | | | | | | | | | | | | | | | | | | | | | | | | | | | | | | | | | | | | | | | | | | | | | | | | | | | | | | | | | | | | | | | | | | | | | | | | | | | | | | | | | | | | | | | | | | | | | | | | |
| | | | | | | | | | | 150 A | | | | | | | | | | | 175 A | | | | | | | | | | | 175 A | | | | | | | | | | | 200 A | | | | | | | | | | | 200 A | | | | | | | | | | | 225 A | | | | | | | | | | | 225 A | | | | | | | | | | | 250 A | | | | | | | | | | | | | | | | | | | | | | | | | | | | | | | | | | | | | | | | | | | | | | | | | | | | | | | | | | | | | | | | | | | | | | | | | | | | | | | | | | | | | | | | | | | | | | | | | | | | | | | | | | | | | | | | | | | | | | | | | | | | | | | | | | | | | | | | | | | | | | | | | | | | | | | | | | | | | | | | | | | | | | | | | | | | | | | | | | | | | | | | | | | | | | | | | | | | | | | | | | | | | | | | | | | | | | | | | | | | | | | | | | | | | | | | | | | | | | | | | | | | | | | | | | | | | | | | | | | | | | | | | | | | | | | | | | | | | | | | | | | | | | | | | | | | | | | | | | | | | | | | | | | | | | | | | | | | | | | | | | | | | | | | | | | | | | | | | | | | | | | | | | | | | | | | | | | | | | | | | | | | | | | | | | | | | | | | | | | | | | | | | | | | | | | | | | | | | | | | | | | | | | | | | | | | | | | | | | | | | | | | | | | | | | | | | | | | | | | | | | | | | | | | | | | | | | | | | | | | | | | | | | | | | | | | | | | | | | | | | | | | | | | | | | | | | | | | | | | | | | | | | | | | | | | | | | | | | | | | | | | | | | | | | | | | | | | | | | | | | | | | | | | | | | | | | | | | | | | | | | | | | | | | | | | | | | | | | | | | | | | | | | | | | | | | | | | | | | | | | | | | | | | | | | | | | | | | | | | | | | | | | | | | | | | | | | | | | | | | | | | | | | | | | | | | | | | | | | | | | | | | | | | | | | | | | | | | | | | | | | | | | | | |
| | | | | | | | | | | 175 A | | | | | | | | | | | 175 A | | | | | | | | | | | 200 A | | | | | | | | | | | 200 A | | | | | | | | | | | 225 A | | | | | | | | | | | 225 A | | | | | | | | | | | 250 A | | | | | | | | | | | | | | | | | | | | | | | | | | | | | | | | | | | | | | | | | | | | | | | | | | | | | | | | | | | | | | | | | | | | | | | | | | | | | | | | | | | | | | | | | | | | | | | | | | | | | | | | | | | | | | | | | | | | | | | | | | | | | | | | | | | | | | | | | | | | | | | | | | | | | | | | | | | | | | | | | | | | | | | | | | | | | | | | | | | | | | | | | | | | | | | | | | | | | | | | | | | | | | | | | | | | | | | | | | | | | | | | | | | | | | | | | | | | | | | | | | | | | | | | | | | | | | | | | | | | | | | | | | | | | | | | | | | | | | | | | | | | | | | | | | | | | | | | | | | | | | | | | | | | | | | | | | | | | | | | | | | | | | | | | | | | | | | | | | | | | | | | | | | | | | | | | | | | | | | | | | | | | | | | | | | | | | | | | | | | | | | | | | | | | | | | | | | | | | | | | | | | | | | | | | | | | | | | | | | | | | | | | | | | | | | | | | | | | | | | | | | | | | | | | | | | | | | | | | | | | | | | | | | | | | | | | | | | | | | | | | | | | | | | | | | | | | | | | | | | | | | | | | | | | | | | | | | | | | | | | | | | | | | | | | | | | | | | | | | | | | | | | | | | | | | | | | | | | | | | | | | | | | | | | | | | | | | | | | | | | | | | | | | | | | | | | | | | | | | | | | | | | | | | | | | | | | | | | | | | | | | | | | | | | | | | | | | | | | | | | | | | | | | | | | | | | | | | | | | | | | | | | | | | | | | | | | | | | | | | | | | | | | | | | | | | | | | | | | |
| | | | | | | | | | | 175 A | | | | | | | | | | | 200 A | | | | | | | | | | | 200 A | | | | | | | | | | | 225 A | | | | | | | | | | | 225 A | | | | | | | | | | | 250 A | | | | | | | | | | | | | | | | | | | | | | | | | | | | | | | | | | | | | | | | | | | | | | | | | | | | | | | | | | | | | | | | | | | | | | | | | | | | | | | | | | | | | | | | | | | | | | | | | | | | | | | | | | | | | | | | | | | | | | | | | | | | | | | | | | | | | | | | | | | | | | | | | | | | | | | | | | | | | | | | | | | | | | | | | | | | | | | | | | | | | | | | | | | | | | | | | | | | | | | | | | | | | | | | | | | | | | | | | | | | | | | | | | | | | | | | | | | | | | | | | | | | | | | | | | | | | | | | | | | | | | | | | | | | | | | | | | | | | | | | | | | | | | | | | | | | | | | | | | | | | | | | | | | | | | | | | | | | | | | | | | | | | | | | | | | | | | | | | | | | | | | | | | | | | | | | | | | | | | | | | | | | | | | | | | | | | | | | | | | | | | | | | | | | | | | | | | | | | | | | | | | | | | | | | | | | | | | | | | | | | | | | | | | | | | | | | | | | | | | | | | | | | | | | | | | | | | | | | | | | | | | | | | | | | | | | | | | | | | | | | | | | | | | | | | | | | | | | | | | | | | | | | | | | | | | | | | | | | | | | | | | | | | | | | | | | | | | | | | | | | | | | | | | | | | | | | | | | | | | | | | | | | | | | | | | | | | | | | | | | | | | | | | | | | | | | | | | | | | | | | | | | | | | | | | | | | | | | | | | | | | | | | | | | | | | | | | | | | | | | | | | | | | | | | | | | | | | | | | | | | | | | | | | | | | | | | | | | | | | | | | | | | | | | | | | | | | | | | | | | | | | | | | | | | |
| | | | | | | | | | | 200 A | | | | | | | | | | | 200 A | | | | | | | | | | | 225 A | | | | | | | | | | | 225 A | | | | | | | | | | | 250 A | | | | | | | | | | | | | | | | | | | | | | | | | | | | | | | | | | | | | | | | | | | | | | | | | | | | | | | | | | | | | | | | | | | | | | | | | | | | | | | | | | | | | | | | | | | | | | | | | | | | | | | | | | | | | | | | | | | | | | | | | | | | | | | | | | | | | | | | | | | | | | | | | | | | | | | | | | | | | | | | | | | | | | | | | | | | | | | | | | | | | | | | | | | | | | | | | | | | | | | | | | | | | | | | | | | | | | | | | | | | | | | | | | | | | | | | | | | | | | | | | | | | | | | | | | | | | | | | | | | | | | | | | | | | | | | | | | | | | | | | | | | | | | | | | | | | | | | | | | | | | | | | | | | | | | | | | | | | | | | | | | | | | | | | | | | | | | | | | | | | | | | | | | | | | | | | | | | | | | | | | | | | | | | | | | | | | | | | | | | | | | | | | | | | | | | | | | | | | | | | | | | | | | | | | | | | | | | | | | | | | | | | | | | | | | | | | | | | | | | | | | | | | | | | | | | | | | | | | | | | | | | | | | | | | | | | | | | | | | | | | | | | | | | | | | | | | | | | | | | | | | | | | | | | | | | | | | | | | | | | | | | | | | | | | | | | | | | | | | | | | | | | | | | | | | | | | | | | | | | | | | | | | | | | | | | | | | | | | | | | | | | | | | | | | | | | | | | | | | | | | | | | | | | | | | | | | | | | | | | | | | | | | | | | | | | | | | | | | | | | | | | | | | | | | | | | | | | | | | | | | | | | | | | | | | | | | | | | | | | | | | | | | | | | | | | | | | | | | | | | | | | | | | | | | | | | | | | | | | | | |
| | | | | | | | | | | 200 A | | | | | | | | | | | 225 A | | | | | | | | | | | 225 A | | | | | | | | | | | 250 A | | | | | | | | | | | | | | | | | | | | | | | | | | | | | | | | | | | | | | | | | | | | | | | | | | | | | | | | | | | | | | | | | | | | | | | | | | | | | | | | | | | | | | | | | | | | | | | | | | | | | | | | | | | | | | | | | | | | | | | | | | | | | | | | | | | | | | | | | | | | | | | | | | | | | | | | | | | | | | | | | | | | | | | | | | | | | | | | | | | | | | | | | | | | | | | | | | | | | | | | | | | | | | | | | | | | | | | | | | | | | | | | | | | | | | | | | | | | | | | | | | | | | | | | | | | | | | | | | | | | | | | | | | | | | | | | | | | | | | | | | | | | | | | | | | | | | | | | | | | | | | | | | | | | | | | | | | | | | | | | | | | | | | | | | | | | | | | | | | | | | | | | | | | | | | | | | | | | | | | | | | | | | | | | | | | | | | | | | | | | | | | | | | | | | | | | | | | | | | | | | | | | | | | | | | | | | | | | | | | | | | | | | | | | | | | | | | | | | | | | | | | | | | | | | | | | | | | | | | | | | | | | | | | | | | | | | | | | | | | | | | | | | | | | | | | | | | | | | | | | | | | | | | | | | | | | | | | | | | | | | | | | | | | | | | | | | | | | | | | | | | | | | | | | | | | | | | | | | | | | | | | | | | | | | | | | | | | | | | | | | | | | | | | | | | | | | | | | | | | | | | | | | | | | | | | | | | | | | | | | | | | | | | | | | | | | | | | | | | | | | | | | | | | | | | | | | | | | | | | | | | | | | | | | | | | | | | | | | | | | | | | | | | | | | | | | | | | | | | | | | | | | | | | | | | | | | | | | | | | | | | | | | | | | | | | |
| | | | | | | | | | | 225 A | | | | | | | | | | | 225 A | | | | | | | | | | | 250 A | | | | | | | | | | | | | | | | | | | | | | | | | | | | | | | | | | | | | | | | | | | | | | | | | | | | | | | | | | | | | | | | | | | | | | | | | | | | | | | | | | | | | | | | | | | | | | | | | | | | | | | | | | | | | | | | | | | | | | | | | | | | | | | | | | | | | | | | | | | | | | | | | | | | | | | | | | | | | | | | | | | | | | | | | | | | | | | | | | | | | | | | | | | | | | | | | | | | | | | | | | | | | | | | | | | | | | | | | | | | | | | | | | | | | | | | | | | | | | | | | | | | | | | | | | | | | | | | | | | | | | | | | | | | | | | | | | | | | | | | | | | | | | | | | | | | | | | | | | | | | | | | | | | | | | | | | | | | | | | | | | | | | | | | | | | | | | | | | | | | | | | | | | | | | | | | | | | | | | | | | | | | | | | | | | | | | | | | | | | | | | | | | | | | | | | | | | | | | | | | | | | | | | | | | | | | | | | | | | | | | | | | | | | | | | | | | | | | | | | | | | | | | | | | | | | | | | | | | | | | | | | | | | | | | | | | | | | | | | | | | | | | | | | | | | | | | | | | | | | | | | | | | | | | | | | | | | | | | | | | | | | | | | | | | | | | | | | | | | | | | | | | | | | | | | | | | | | | | | | | | | | | | | | | | | | | | | | | | | | | | | | | | | | | | | | | | | | | | | | | | | | | | | | | | | | | | | | | | | | | | | | | | | | | | | | | | | | | | | | | | | | | | | | | | | | | | | | | | | | | | | | | | | | | | | | | | | | | | | | | | | | | | | | | | | | | | | | | | | | | | | | | | | | | | | | | | | | | | | | | | | | | | | | | | | | | | | | | | | | | | | |
| | | | | | | | | | | 225 A | | | | | | | | | | | 250 A | | | | | | | | | | | | | | | | | | | | | | | | | | | | | | | | | | | | | | | | | | | | | | | | | | | | | | | | | | | | | | | | | | | | | | | | | | | | | | | | | | | | | | | | | | | | | | | | | | | | | | | | | | | | | | | | | | | | | | | | | | | | | | | | | | | | | | | | | | | | | | | | | | | | | | | | | | | | | | | | | | | | | | | | | | | | | | | | | | | | | | | | | | | | | | | | | | | | | | | | | | | | | | | | | | | | | | | | | | | | | | | | | | | | | | | | | | | | | | | | | | | | | | | | | | | | | | | | | | | | | | | | | | | | | | | | | | | | | | | | | | | | | | | | | | | | | | | | | | | | | | | | | | | | | | | | | | | | | | | | | | | | | | | | | | | | | | | | | | | | | | | | | | | | | | | | | | | | | | | | | | | | | | | | | | | | | | | | | | | | | | | | | | | | | | | | | | | | | | | | | | | | | | | | | | | | | | | | | | | | | | | | | | | | | | | | | | | | | | | | | | | | | | | | | | | | | | | | | | | | | | | | | | | | | | | | | | | | | | | | | | | | | | | | | | | | | | | | | | | | | | | | | | | | | | | | | | | | | | | | | | | | | | | | | | | | | | | | | | | | | | | | | | | | | | | | | | | | | | | | | | | | | | | | | | | | | | | | | | | | | | | | | | | | | | | | | | | | | | | | | | | | | | | | | | | | | | | | | | | | | | | | | | | | | | | | | | | | | | | | | | | | | | | | | | | | | | | | | | | | | | | | | | | | | | | | | | | | | | | | | | | | | | | | | | | | | | | | | | | | | | | | | | | | | | | | | | | | | | | | | | | | | | | | | | | | | | | | | | | | | | | | | | | | | | | | | |
| | | | | | | | | | | 250 A | | | | | | | | | | | | | | | | | | | | | | | | | | | | | | | | | | | | | | | | | | | | | | | | | | | | | | | | | | | | | | | | | | | | | | | | | | | | | | | | | | | | | | | | | | | | | | | | | | | | | | | | | | | | | | | | | | | | | | | | | | | | | | | | | | | | | | | | | | | | | | | | | | | | | | | | | | | | | | | | | | | | | | | | | | | | | | | | | | | | | | | | | | | | | | | | | | | | | | | | | | | | | | | | | | | | | | | | | | | | | | | | | | | | | | | | | | | | | | | | | | | | | | | | | | | | | | | | | | | | | | | | | | | | | | | | | | | | | | | | | | | | | | | | | | | | | | | | | | | | | | | | | | | | | | | | | | | | | | | | | | | | | | | | | | | | | | | | | | | | | | | | | | | | | | | | | | | | | | | | | | | | | | | | | | | | | | | | | | | | | | | | | | | | | | | | | | | | | | | | | | | | | | | | | | | | | | | | | | | | | | | | | | | | | | | | | | | | | | | | | | | | | | | | | | | | | | | | | | | | | | | | | | | | | | | | | | | | | | | | | | | | | | | | | | | | | | | | | | | | | | | | | | | | | | | | | | | | | | | | | | | | | | | | | | | | | | | | | | | | | | | | | | | | | | | | | | | | | | | | | | | | | | | | | | | | | | | | | | | | | | | | | | | | | | | | | | | | | | | | | | | | | | | | | | | | | | | | | | | | | | | | | | | | | | | | | | | | | | | | | | | | | | | | | | | | | | | | | | | | | | | | | | | | | | | | | | | | | | | | | | | | | | | | | | | | | | | | | | | | | | | | | | | | | | | | | | | | | | | | | | | | | | | | | | | | | | | | | | | | | | | | | | | | | | | | | | | | | | | | | | | | |

[1] Motor full load currents thru 200 hp are taken from NEC Tables 430.247, 248 and 250. Above 200 hp from UL 98. Select wire size, circuit breakers, or fuses on basis of hp rather than nameplate full load current per NEC 430.6. Do not use these values to select overload relay thermal units. See Digest pages 16-129—16152 for selection of thermal units when actual full load current is not known. Voltages listed are rated motor voltages. Corresponding nominal system voltages are 110–120 V, 200–208 V, 220–240 V, 440–480 V and 550–600 V

[2] Thermal-magnetic circuit breaker ampere ratings recommended are approximate for average conditions, based on trip characteristics of Square D circuit breakers and NEC Table 430.52. Under some conditions, the next size larger switch or circuit breaker rating may be necessary to accommodate the motor starting current and is permitted by NEC 430.52(C)(1) Exception 2. High starting currents are anticipated with Design E and other energy efficient motors. For explanation of Code letter markings, see NEC 430.7(B). For Busway Plug-in units, see page 9-7.

[3] Switch size only is shown in table. Selected fuses should not exceed maximum percent of full-load current as given in NEC Table 430.52. Above 50 hp dc switches are not hp rated by UL as Motor Circuit Switches, but as General Use Switches only and are not necessarily capable of interrupting the max. operating overload current of a motor. See NEC 100 for definition of General Use Switch. When protecting a 3Ø, Design E energy efficient motor, the switch is required by NEC 430.109 to have a hp rating of not less than 1.4 times that of a motor rated 3–100 hp, or not less than 1.3 times that of a motor rated over 100 hp. Switches shown in this table do not necessarily comply with that requirement.

[4] NEC 430.22 for Single Motor. Smaller conductors may be permitted for light duty-cycle service per 430.22 (B) Exception No. 1. DC motors operating from rectified 1Ø power supply will require larger conductors per 430.22 (A) Exception No. 1. For motor-generator arc welders, see 630.11

[5] Thermal-magnetic breaker ampere ratings recommended are approximate for average conditions and based on trip characteristics of Square D circuit breakers and NEC Tables 430.7 (B) and 430.52.

[6] Ordinary service for normal starting duty only, acceleration time of 10 sec. or less.

[7] Heavy service is jogging or plugging duty or cycling load with over 25 starts per hour or over 5 starts per minute. Energy efficient motors are polyphase motors defined in NEMA Standard MG1 and exhibit high starting current.

[8] 200 V motors are commonly used on 208 V services.

[9] 8 XHHW requires 3/4 in. conduit for 3W.

Table 7.91 Selection Tables for Conductors, Safety Switches and Thermal-Magnetic Circuit Breakers Based on 2017 NEC® Tables 430.247, 430.248 & 430.250 (cont'd.)

| Horsepower Ratings | | | | | | | | | | Amperage of Thermal-Magnetic [11] Inverse Time Circuit Breaker | | | QMB and Heavy Duty Switch with Time Delay Fuses [12] | Minimum Size metallic Conduit 75° C, C Wire Field-Installed Sized for 125% FLA [13] | | |
|---|---------|---------|---------|-------------|--------------|---------|---|---------|-------------------------|--|---|-----------------------------------|--|---|----------------|---------------|
| Squirrel-Cage and Wound-Rotor Motors with Norm. Torque Characteristics Operating at Usual Speeds 3Ø 60 Hz | | | | 1Ø 10 Hz ac | | | Average Direct Current Motors Operating at Base Speed | | Full Load Amperage [10] | For Motor Code Letter B to E | | For Motor Code Letter F to V [14] | | AWG kcmil | Conduit 3 W | |
| 200 Vac [17] | 230 Vac | 460 Vac | 575 Vac | 115 Vac | 200 Vac [17] | 230 Vac | 120 Vdc | 240 Vdc | | Ordinary Service [15] | Heavy Service and Energy Efficient [16] | | | | THHN THWN XHHW | THW |
| 30 | | | | | | | | | 92.0 A | | | | | | | |
| | | 75 | | | | | | | 96.0 A | | | | | | | |
| | | | 100 | | | | | | 99.0 A | | | | | | | |
| | | | | 10 | | | | | 100.0 A | 150 A | 200 A | 250 A | 1 | 1-1/4 in. | 1-1/2 in. | |
| | 40 | | | | | | | | 104.0 A | | 225 A | 300 A | | | | |
| | | | | | | | | 30 | 106.0 A | 175 A | | | 1/0 | 1-1/4 in. | 1-1/2 in. | |
| 40 | | | | | | | | | 120.0 A | | 250 A | | | | | |
| | | 100 | | | | | | | 124.0 A | | 250 A | 350 A | 2/0 | 1-1/2 in. | 1-1/2 in. | |
| | | | 125 | | | | | | 125.0 A | | | | | | | |
| | 50 | | | | | | | | 130.0 A | | | | | | | |
| | | | | | | | | 40 | 140.0 A | 200 A | 300 A | | | | | |
| | | | 150 | | | | | | 144.0 A | | | | | | | |
| 50 | | | | | | | | | 150.0 A | | | | 3/0 | 1-1/2 in. | 2 in. | |
| | 60 | | | | | | | | 154.0 A | | | 400 A | | | | |
| | | 125 | | | | | | | 156.0 A | 225 A | 350 A | | | | | |
| | | | | | | | | 50 | 173.0 A | | | | | | | |
| 60 | | | | | | | | | 177.0 A | | | | 4/0 | 2 in. | 2 in. | |
| | | 150 | | | | | | | 180.0 A | 250 A | 400 A | 500 A | | | | |
| | 75 | | 200 | | | | | | 192.0 A | | | | 250 | 2 in. | 2 in. | |
| | | | | | | | | | 221.0 A | 300 A | 450 A | 600 A | 300 | 2 in. | 2-1/2 in. | |
| | | 200 | | | | | | | 240.0 A | | | | | | | |
| | | | 250 | | | | | | 242.0 A | 350 A | 500 A | 700 A | 350 | 2-1/2 in. | 2-1/2 in. | |
| | 100 | | | | | | | | 248.0 A | | | | | | | |
| 100 | | | | | | | | | 285.0 A | | | | | | | |
| | | | 300 | | | | | | 289.0 A | 400 A | 600 A | 800 A | 500 | 3 in. | 3 in. | |
| | | 250 | | | | | | | 302.0 A | | | | | | | |
| | 125 | | | | | | | | 312.0 A | 450 A | 700 A | | (2) 3/0 | (2) 2-1/2 in. | (2) 2 in. | |
| | | | 350 | | | | | | 336.0 A | 500 A | | | | | | |
| 125 | | | | | | | | | 359.0 A | | | | | | | |
| | 150 | | | | | | | | 360.0 A | | | | (2) 4/0 | (2) 2 in. | (2) 2 in. | |
| | | 300 | | | | | | | 361.0 A | 600 A | 800 A | 1000 A | | | | |
| | | | 400 | | | | | | 382.0 A | | | | | | | |
| 150 | | 350 | | | | | | | 414.0 A | | 900 A | | (2)300 | (2) 2 in. | (2) 2-1/2 in. | |
| | | | | 500 | | | | | 472.0 A | | | 1200 A | | | | |
| | | | 400 | | | | | | 477.0 A | 800 A | 1000 A | | (2) 350 | (2) 2-1/2 in. | (2) 2-1/2 in. | |
| | | 200 | | | | | | | 480.0 A | | | | | | | |
| 200 | | | | | | | | | 552.0 A | | | | | | | |
| | | 500 | | | | | | | 590.0 A | | 1200 A | 1600 A | — | (3) 300 | (3) 2 in. | (3) 2-1/2 in. |
| | 250 | | | | | | | | 602.0 A | 900 A | | | | | | |

Contact your local Field Office for circuit breaker selection on constant horsepower multi-speed motors.

[10] Motor full load currents thru 200 hp are taken from NEC Tables 430.247, 248 and 250. Above 200 hp from UL 98. Select wire size, circuit breakers, or fuses on basis of hp rather than nameplate full load current per NEC 430.6. Do not use these values to select overload relay thermal units. See Digest pages 16-129—16152 for selection of thermal units when actual full load current is not known. Voltages listed are rated motor voltages. Corresponding nominal system voltages are 110–120 V, 200–208 V, 220–240 V, 440–480 V and 550–600 V

[11] Thermal-magnetic circuit breaker ampere ratings recommended are approximate for average conditions, based on trip characteristics of Square D circuit breakers and NEC Table 430.52. Under some conditions, the next size larger switch or circuit breaker rating may be necessary to accommodate the motor starting current and is permitted by NEC 430.52(C)(1) Exception 2. High starting currents are anticipated with Design E and other energy efficient motors. For explanation of Code letter markings, see NEC 430.7(B). For Busway Plug-in units, see page 9-7.

[12] Switch size only is shown in table. Selected fuses should not exceed maximum percent of full-load current as given in NEC Table 430.52. Above 50 hp dc switches are not hp rated by UL as Motor Circuit Switches, but as General Use Switches only and are not necessarily capable of interrupting the max. operating overload current of a motor. See NEC 100 for definition of General Use Switch. When protecting a 3Ø, Design E energy efficient motor, the switch is required by NEC 430.109 to have a hp rating of not less than 1.4 times that of a motor rated 3–100 hp, or not less than 1.3 times that of a motor rated over 100 hp. Switches shown in this table do not necessarily comply with that requirement.

[13] NEC 430.22 for Single Motor. Smaller conductors may be permitted for light duty-cycle service per 430.22 (B) Exception No. 1. DC motors operating from rectified 1Ø power supply will require larger conductors per 430.22 (A) Exception No. 1. For motor-generator arc welders, see 630.11

[14] Thermal-magnetic breaker ampere ratings recommended are approximate for average conditions and based on trip characteristics of Square D circuit breakers and NEC Tables 430.7(B) and 430.52.

[15] Ordinary service for normal starting duty only, acceleration time of 10 sec. or less.

[16] Heavy service is jogging or plugging duty or cycling load with over 25 starts per hour or over 5 starts per minute. Energy efficient motors are polyphase motors defined in NEMA Standard MG1 and exhibit high starting current.

[17] 200 V motors are commonly used on 208 V services.

Accessories see page 7-55 and Supplemental Digest Section 3
Optional Lugs see page 7-60 and Supplemental Digest Section 3
Dimensions see page 7-86
Enclosures see page 7-87

PowerPacT Motor Protector Circuit Breakers—Two Device Solutions

MicroLogic 2.2M and 2.3M trip units provide built-in thermal and magnetic protections. Use PowerPacT Motor Protect Circuit Breakers in two-device motor feeder solutions to provide protection against short-circuits, overloads, and phase unbalance.

- Protection settings are made using a rotary switch.
- Accept the same accessories and terminals as equivalent PowerPacT circuit breakers.
- UL, CSA, NOM, IEC, CCC certified, and UKCA and CE marked for global acceptance.

Table 7.92: H-Frame (150 A), J-Frame (250 A) and L-Frame (600 A) Electronic Motor Protector Circuit Breakers (UL Ratings)—Two Device Solutions [10]

| Electronic Trip Unit Type | Frame | Sensor Rating | Trip Unit | Full Load Amperes Range (FLA) | Isd (x FLA) | Interrupting Rating | | | |
|---------------------------|---------|---------------|-----------|-------------------------------|--------------|---------------------|--------------|--------------|--------------|
| | | | | | | G | J | L | R |
| Standard [11] | H-Frame | 30 | 2.2 M | 14–25 | 5-13 x FLA | HGL36030M38X | HJL36030M38X | HLL36030M38X | HRL36030M38X |
| | | 50 | | 14–42 | 5-13 x FLA | HGL36050M38X | HJL36050M38X | HLL36050M38X | HRL36050M38X |
| | | 100 | | 30–80 | 5-13 x FLA | HGL36100M38X | HJL36100M38X | HLL36100M38X | HRL36100M38X |
| | | 150 | | 58–130 | 5-13 x FLA | HGL36150M38X | HJL36150M38X | HLL36150M38X | HRL36150M38X |
| | | 250 | | 114–217 | 5-13 x FLA | JGL36250M38X | JLJ36250M38X | JLL36250M38X | JRL36250M38X |
| | | 400 | | 190–348 | 5-13 x FLA | LGL36400M38X | LJL36400M38X | LLL36400M38X | LRL36400M38X |
| | L-Frame | 600 | 312–520 | 5-13 x FLA | LGL36600M38X | LJL36600M38X | LLL36600M38X | LRL36600M38X | |

To select combination starters and motor controllers using MCP's meeting NEC Article 430, refer to Section 16.

PowerPacT H, J, and L-Frame Motor Protectors

Table 7.93: Application of PowerPacT H- and L-Frame Motor Protector Circuit Breaker

| 200 Vac | Hp Ratings of Induction Type Squirrel-Cage and Wound Rotor Motors 3Ø 60 Hz | | | Full Load Amperes [12] | PowerPacT Family Motor Protector Circuit Breaker Cat. No. [13] | Magnetic Trip Settings [14] | |
|---------|--|---------|---------|------------------------|--|-----------------------------|-------|
| | 230 Vac | 460 Vac | 575 Vac | | | MIN | MAX |
| | | 10 | | 14 | H(L)JL36030M38X | 500% | 1300% |
| | 5 | | | 15.2 | H(L)JL36030M38X | | |
| | | | 15 | 17 | H(L)JL36030M38X | | |
| 5 | | | | 17.5 | H(L)JL36030M38X | | |
| | | 15 | | 21 | H(L)JL36030M38X | | |
| | 7-1/2 | | 20 | 22 | H(L)JL36030M38X | | |
| | | | | 25.3 | H(L)JL36030M38X | 500% | 1300% |
| | | 20 | 25 | 27 | H(L)JL36050M38X | | |
| | 10 | | | 28 | H(L)JL36050M38X | | |
| | | | 30 | 32 | H(L)JL36050M38X | | |
| 10 | | | | 32.2 | H(L)JL36050M38X | | |
| | | 25 | | 34 | H(L)JL36050M38X | | |
| | | 30 | | 40 | H(L)JL36050M38X | 500% | 1300% |
| | | | 40 | 41 | H(L)JL36050M38X | | |
| | 15 | | | 42 | H(L)JL36050M38X | | |
| | | | 40 | 48.3 | H(L)JL36100M38X | | |
| 15 | | 40 | 50 | 52 | H(L)JL36100M38X | | |
| | 20 | | | 54 | H(L)JL36100M38X | | |
| | | | 60 | 62 | H(L)JL36100M38X | 500% | 1300% |
| | | 50 | | 65 | H(L)JL36100M38X | | |
| | | | | | J(L)JL36250M38X | | |
| 75 | | | | 221 | L(L)JL36400M38X | | |
| | | 200 | | 240 | L(L)JL36400M38X | | |
| | | | 250 | 242 | L(L)JL36400M38X | | |
| | 100 | | | 248 | L(L)JL36400M38X | 500% | 1300% |
| | | | | 285 | L(L)JL36400M38X | | |
| 100 | | | 300 | 289 | L(L)JL36400M38X | | |
| | | 250 | | 302 | L(L)JL36400M38X | | |
| | 125 | | | 312 | L(L)JL36400M38X | | |
| | | | 350 | 336 | L(L)JL36400M38X | | |
| | 125 | | | 359 | L(L)JL36600M38X | 500% | 1300% |
| | | 150 | | 360 | L(L)JL36600M38X | | |
| | | | 300 | 361 | L(L)JL36600M38X | | |
| | | | 400 | 382 | L(L)JL36600M38X | | |
| 150 | | 350 | | 414 | L(L)JL36600M38X | | |
| | | | 500 | 472 | L(L)JL36600M38X | | |
| | | 400 | | 477 | L(L)JL36600M38X | 500% | 1300% |
| | 200 | | | 480 | L(L)JL36600M38X | | |



HJL36100M38X Motor Circuit Protector

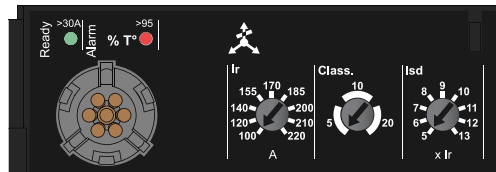

MicroLogic 2.2M and 2.3M Trip Units

Ii=4800A

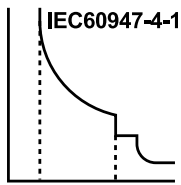

[10] Two-device solutions (these electronic motor protector circuit breakers include short circuit and overload protection)

- 1 electronic motor circuit protector with a MicroLogic 2.2 M plus
- 1 contactor

[11] The standard trip unit offers Class 5, 10 and 20 and phase unbalance or phase loss protection.

[12] Motor full-load currents are taken from NEC Table 430.250. Select wire and circuit breakers on basis of horsepower rather than nameplate full-load current per NEC 430.6 (A) for general motor applications. Do not use these values to select overload relay thermal units. See Digest Section 14 for selection of thermal units when actual full load current is not known. The voltages listed are rated motor voltages. Corresponding nominal system voltages are 200–208, 220–240, 440–480 and 550–600 V.

[13] To complete catalog number, replace the blank with the appropriate rating (G, J, L or R).

[14] Only MIN and MAX settings are shown, intermediate settings are available on all circuit breakers.

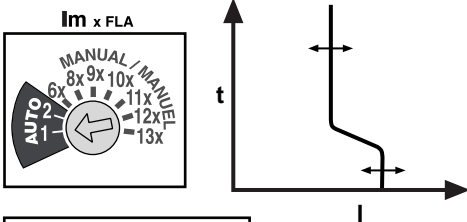
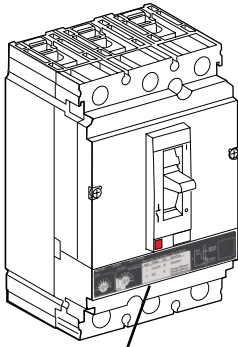

| Motor Type / Tipo de Motor / Type de Moteur | | | |
|---|------------|-----|---|
| Auto | NEMA | IEC | Type/Tipo |
| 1 | A, B, C, D | N | Standard |
| 2 | B, E | H | Energy Efficient Energie Efficace Energia Efficente |

Motor Circuit Protection Selection

PowerPacT H- and J-frame electronic Motor Circuit Protectors (MCP) are magnetic-only instantaneous-trip circuit breakers. They are designed to offer short circuit protection and are National Electrical Code (NEC) compliant when installed as part of a combination controller having motor overload protection. MCP circuit breakers accept the same accessories and terminals as the equivalent thermal-magnetic circuit breakers.

Determine the hp rating from the nameplate of the motor. Select a MCP with an ampere rating recommended for the hp and voltage involved. When using the automatic settings the MCP microprocessor automatically adjusts the trip settings for both current and time to align with the start-up characteristic for the motor type, whether it is a standard or energy-efficient motor. This includes a dampening means to accommodate a transient motor in-rush current without nuisance tripping of the circuit breaker.

Table 7.94: H- and J-Frame Electronic Motor Circuit Protectors (MCP)

| Frame | Sensor Rating | Full Load Amperes Range | Adjustable Instantaneous Trip Range | Suffix | J (See SCCR Cat. No. Table Below) | L (See SCCR Cat. No. Table Below) | R (See SCCR Cat. No. Table Below) |
|---------|---------------|-------------------------|-------------------------------------|--------|-----------------------------------|-----------------------------------|-----------------------------------|
| H-Frame | 30 A | 1.5–25 A | 9–325 A | M71 | HJL36030-M71 | HLL36030-M71 | HRL36030M71 |
| | 50 A | 14–42 A | 84–546 A | M72 | HJL36050-M72 | HLL36050-M72 | HRL36050M72 |
| | 100 A | 30–80 A | 180–1040 A | M73 | HJL36100-M73 | HLL36100-M73 | HRL36100M73 |
| | 150 A | 58–130 A | 348–1690 A | M74 | HJL36150-M74 | HLL36150-M74 | HRL36150M74 |
| J-Frame | 250 A | 114–217 A | 684–2500 A | M75 | JJL36250-M75 | JLL36250-M75 | JRL36250M75 |

Table 7.95: Maximum Rating or Setting of Motor Protective Devices [15]

| Type of Motor | Percentage of Full-load Current | |
|---------------|---------------------------------|--------------------|
| | Setting | Not to Exceed [16] |
| A, B, C, D | Standard | 800% |
| B, E | Energy Efficient | 1100% |
| | | 1300% |
| | | 1700% |

Table 7.96: MCP Selection by HP Ratings [17] of Induction-type Squirrel-Cage and Wound-Rotor Motors [18]

| 3Ø60 Hz Voltages [19] | | | | Full-Load Amperes | Suffix |
|-----------------------|---------|---------|---------|-------------------|--------|
| 200 Vac | 230 Vac | 460 Vac | 575 Vac | | |
| 5–5 | 5–7.5 | .75–15 | 1–20 | 1.5–25 | M71 |
| 5–10 | 5–15 | 10–30 | 15–40 | 14–42 | M72 |
| 10–25 | 15–30 | 25–60 | 30–75 | 30–80 | M73 |
| 20–40 | 25–50 | 50–100 | 60–125 | 58–130 | M74 |
| 40–60 | 50–75 | 100–150 | 125–200 | 114–217 | M75 |

Short Circuit Current Rating (SCCR)

Tested to meet NEC and UL508A requirements for short circuit current ratings as part of an approved combination controller.

Table 7.97: Short Circuit Current Ratings (SCCR)

| Contactor/Starter | Interrupting Rating | | | | | |
|-------------------------|---------------------|---------|---------|-------------|---------|---------|
| | J | | | L | | |
| | 200–240 Vac | 480 Vac | 600 Vac | 200–240 Vac | 480 Vac | 600 Vac |
| Tesys D-line and F-line | 100 kA | 65 kA | 25 kA | 125 kA | 100 kA | 50 kA |
| NEMA Type S | 100 kA | 65 kA | 25 kA | 125 kA | 100 kA | 50 kA |

See www.us.schneider-electric.us for specific ratings and combination ID numbers.

To select combination starters and motor controllers using MCP's Meeting NEC Article 430, refer to Section 16.

Accessories see page 7-55
Lugs see page 7-60
Dimensions see page 7-86
Enclosures see page 7-87

H-, J-Frame Motor Circuit Protectors

Table 7.98: Application of PowerPacT™ H-Frame and J-Frame Electronic Motor Circuit Protectors (MCP)

| Starter Size | Horsepower Rating of Induction-Type Squirrel-Cage and Wound-Rotor Motors 3Ø 60 Hz | | | | NEC Full Load Amperes | PowerPacT H-Frame and J-Frame Electronic MCP |
|--------------|---|---------|---------|---------|-----------------------|--|
| | 200 Vac | 230 Vac | 480 Vac | 575 Vac | | |
| 00 | | | 1/2 | 1/2 | 0.9 A | HJL36030M71 and HLL36030M71 1/2–10 hp |
| | | | | 3/4 | 1.1 A | |
| | | | | | 1.3 A | |
| | | | 3/4 | 1 | 1.7 A | |

[15] Based on 2015 NEC Table 430.52.

[16] See NEC Exception No. 1 to Table 430.52. The NEC 1300% maximum setting may be inadequate for instantaneous trip circuit breakers to withstand current surges typical of the magnetization current of autotransformer type reduced voltage starters, or open transition wye-delta starters during transfer from "start" to "run," constant hp multi-speed motors, and motors labeled "high efficiency."

[17] Based on 2005 NEC Table 430.250.

[18] Per NEC 430.3, part-winding motors should select two circuit breakers, each at not more than one-half the allowable trip setting for the horsepower rating. The two circuit breakers should operate simultaneously as a disconnecting means per NEC 430.103.

[19] Listed voltages are rated motor voltages. Corresponding system voltages are 200 Vac, 220–240 Vac, 440–480 Vac and 550–600 Vac. Select wire and circuit breakers based on horsepower rather than nameplate full-load current per NEC 430.6 (A) for general motor applications.





Table 7.98 Application of PowerPacT™ H-Frame and J-Frame Electronic Motor Circuit Protectors (MCP) (cont'd.)

| Horsepower Rating of Induction-Type Squirrel-Cage and Wound-Rotor Motors 3Ø 60 Hz | | | | | NEC Full Load Amperes | PowerPacT H-Frame and J-Frame Electronic MCP |
|---|---------|---------|---------|---------|-----------------------|--|
| Starter Size | 200 Vac | 230 Vac | 480 Vac | 575 Vac | | |
| | | | 1 | | 2.1 A | |
| | | | | | 2.2 A | |
| | | | 1/2 | | 2.4 A | |
| | | 1/2 | | | 2.5 A | |
| | | | | | 2.7 A | |
| | | | | 1-1/2 | 3 A | |
| | | | 3/4 | | 3.2 A | |
| | | | | 2 | 3.4 A | |
| | | 3/4 | | | 3.7 A | |
| | | | | | 3.9 A | |
| | | | 1 | | 4.2 A | |
| | | | | 3 | 4.8 A | |
| | | | 1-1/2 | | 6 A | |
| | | | | | 6.1 A | |
| | | 2 | | 6.8 A | | |
| | 1-1/2 | | | 6.9 A | | |
| | | | | 7.6 A | | |
| | | | 5 | 7.8 A | | |
| 0 | 2 | | 5 | 9 A | | |
| | | | | 9.6 A | | |
| | | 3 | | 11 A | | |
| | | | 7-1/2 | 10 | 14 A | |
| 1 | | | 10 | 15.2 A | | |
| | | | | 17 A | | |
| | | | | 17.5 A | | |
| | | 5 | | 21 A | | |
| | | | 15 | 22 A | | |
| | | | | 25.3 A | | |
| | | 7-1/2 | 7-1/2 | 20 | 27 A | |
| 2 | | | 20 | 28 A | | |
| | | 10 | | 32 A | | |
| | 10 | | | 32.2 A | | |
| 3 | | | 25 | 34 A | | |
| | | | 30 | 40 A | | |
| | | | | 41 A | | |
| | | 15 | | 42 A | | |
| | | | 40 | 48.3 A | | |
| | | | 50 | 52 A | | |
| | | | | 54 A | | |
| | | 20 | 20 | 62 A | | |
| | | | 50 | 65 A | | |
| | | | 60 | 77 A | | |
| | 25 | | 78.2 A | | | |
| 4 | | 30 | | 80 A | | |
| | | | 75 | 92 A | | |
| | | | | 96 A | | |
| | | | | 99 A | | |
| | | 40 | 40 | 104 A | | |
| 5 | | | 100 | 120 A | | |
| | | | | 124 A | | |
| | | | | 125 A | | |
| | | | | 130 A | | |
| | | 50 | | 144 A | | |
| | | | 125 | 150 A | | |
| | | 60 | | 154 A | | |
| | | | 150 | 156 A | | |
| | | | | 177.1 A | | |
| | | | 150 | 180 A | | |
| | | | 192 A | | | |
| | 75 | 75 | 200 | 221 A | | |
| | | | | 240 A | | |
| | | 100 | 200 | 248 A | | |

*Shaded area is not covered by J-frame electronic motor circuit protector.

PowerPacT Accessories

Table 7.99: Electrical Accessories

| Accessory | Description | Rated Voltage | B-, H-, J-, and L-Frame | | | | | M-, P-, and R-Frame | | | |
|--|---|--|--|--|--------------------------------------|----------------------------|----------------------------|-------------------------------|----------------------------|------------|------------|
| | | | Factory Installed Cat. Suffix | B-Frame | | H- and J-Frame | L-Frame | Factory Installed Cat. Suffix | Field-Installable Cat. No. | | |
| | | | | Field-Installable Cat. No. | Field-Installable Pre-Wired Cat. No. | Field-Installable Cat. No. | Field-Installable Cat. No. | | | | |
|  <p>Auxiliary and Alarm Switches (OF, SD, SDE)</p> <p>B-Frame</p> <p>H-, J-, L-, M-, P, and R-Frame</p> | <p>Provides circuit breaker contact status. Note: The location of the accessory in the circuit breaker determines its function.</p> | Standard Min Load = 10mA with 24V | 1 auxiliary switch (OF) 1a1b | AA | LV426950 | LV426951 | S29450 | S29450 | AA | S29450 | |
| | | | 2 auxiliary switch (OF) 2a2b | AB | — | — | 2x S29450 | 2x S29450 | AB | 2x S29450 | |
| | | | 3 auxiliary switch (OF) 3a3b | AC | — | — | — | 3x S29450 | 3x S29450 | AC | 3x S29450 |
| | | | Alarm Switch (SD) 1a1b | BC | LV426950 | LV426952 | S29450 | S29450 | BC | S29450 | |
| | | | Overcurrent trip switch (SDE) 1a1b | BD | — | — | — | S29450 | BD | S29450 | |
| | | | Consisting of: | OF Switch | — | — | — | S29450 | — | — | |
| | | | | SDE Adapter | — | — | — | S29451 | — | — | |
| | | | Alarm switch and Overcurrent trip switch | BE | — | — | — | 2x S29450 | BE | 2x S29450 | |
| | | | Consisting of: | OF Switch | — | — | — | 2x S29450 | — | — | |
| | | SDE Adapter | | — | — | — | S29451 | — | — | | |
| | | Auxiliary Switch/Alarm Switch/Adapter (OF/SD/SDE) Kit | — | — | — | — | — | — | S33801 [1] | | |
| | | Low Level Min Load = 1mA with 24V | One auxiliary switch (OF) 1a1b | AE | — | — | S29452 | S29452 | AE | S29452 | |
| | | | Two auxiliary switches (OF) 2a2b | AF | — | — | 2x S29452 | 2x S29452 | AF | 2x S29452 | |
| | | | 3 auxiliary switches (OF) 3a3b | AG | — | — | — | 3x S29452 | AG | 3x S29452 | |
| | | | Alarm Switch (SD) 1a1b | BH | — | — | S29452 | S29452 | BH | S29452 | |
| Overcurrent trip switch (SDE) 1a1b | BJ | | — | — | — | S29452 | BJ [2] | S29452 | | | |
| Consisting of: | OF Switch | | — | — | — | S29452 | — | — | | | |
| | SDE Adapter | | — | — | — | S29451 | — | — | | | |
| Alarm switch and Overcurrent trip switch | BK | | — | — | — | 2x S29452 | BK [2] | 2x S29452 | | | |
| Consisting of: | OF Switch | | — | — | — | 2x S29452 | — | — | | | |
| | SDE Adapter [3] | — | — | — | S29451 | — | — | | | | |
|  <p>Shunt Trip (MX)</p> <p>B-Frame</p> <p>H-, J-, and L-Frame</p> | <p>Trips the circuit breaker from a remote location by means of a trip coil energized from a separate supply voltage circuit.</p> | AC | 24 | SK | LV426841 | LV426861 | P29384 | P29384 | SK | S33659 | |
| | | | 48 | SL | LV426842 | LV426862 | P29385 | P29385 | SL | S33660 | |
| | | | 110–130 | SA | LV426843 | LV426863 | P29386 | P29386 | SA | S33661 | |
| | | | 220–240 | SD, SF | — | — | — | — | SC | S33662 | |
| | | | 208–277 | SD | LV426844 | LV426864 | P29387 | P29387 | SD | S33663 | |
| | | | 380–480 | SH | LV426846 | LV426866 | P29388 | P29388 | SH | S33664 | |
| | | 525–600 | SJ | — | — | P29389 | P29389 | — | — | | |
| | | DC | 12 | SN | LV426850 | — | P29382 | P29382 | SN | — | |
| | | | 24 | SO | LV426841 | LV426861 | P29390 | P29390 | SK | S33659 | |
| | | | 30 | SU | — | — | P29391 | P29391 | SK | S33659 | |
| | | | 48 | SP | LV426842 | LV426862 | P29392 | P29392 | SL | S33660 | |
| | | | 60 | SV | — | — | P29383 | P29383 | SL | S33660 | |
| | | | 125 | SR | LV426843 | LV426863 | P29393 | P29393 | SA | S33661 | |
| | | | 250 | SS | LV426844 | LV426864 | P29394 | P29394 | SC | S33662 | |
| | | |  <p>Undervoltage Trip (MN)</p> <p>H-, J-, and L-Frame</p> | <p>Instantaneously opens the circuit breaker when the under-voltage trip supply voltage drops to a value between 35% and 70% of its rated voltage. Closing is allowed when the supply voltage of the undervoltage trip reaches 85% of rated voltage.</p> | AC | 24 | UK | LV426801 | LV426821 | P29404 | P29404 |
| 48 | UL | | | | | LV426802 | LV426822 | P29405 | P29405 | UL | S33669 |
| 110–130 | UA | LV426803 | | | | LV426823 | P29406 | P29406 | UA | S33670 | |
| 220–240 | UC | LV426804 | | | | LV426824 | — | — | UC | S33671 | |
| 208–277 | UD | LV426805 | | | | LV426825 | P29407 | P29407 | — | — | |
| 380–415 | UF | LV426806 | | | | LV426826 | — | — | — | — | |
| 380–480 | UH | LV426807 | | | LV426827 | P29408 | P29408 | UH | S33673 | | |
| 525–600 | UJ | — | | | — | P29409 | P29409 | — | — | | |
| DC | 12 | UN | | | — | — | P29402 | P29402 | — | — | |
| | 24 | UO | | | LV426801 | LV426821 | P29410 | P29410 | UK | S33668 | |
| | 30 | UU | | | — | — | P29411 | P29411 | UK | S33668 | |
| | 48 | UP | | | LV426802 | LV426822 | P29412 | P29412 | UL | S33669 | |
| | 60 | UV | | | — | — | P29403 | P29403 | UL | S33669 | |
| | 125 | UR | | | LV426803 | LV426823 | P29413 | P29413 | UA | S33670 | |
| | 250 | US | | | LV426815 | LV426835 | P29414 | P29414 | UC | S33671 | |
| |  <p>Time Delay Unit</p> | <p>Undervoltage trip with externally mounted adjustable time delay unit for UVR of 0.5, 0.9, 1.5, 3.0 seconds before circuit breaker trips</p> <p>Undervoltage trip with externally mounted non-adjustable time delay unit of 0.25 sec before circuit breaker trips.</p> | AC/DC | 48 | — | S33680 [4] | — | S33680 [4] | S33680 [4] | — | S33680 [4] |
| | | | | 100–130 | — | S33681 [4] | — | S33681 [4] | S33681 [4] | — | S33681 [4] |
| 220–250 | | | | — | S33682 [4] | — | S33682 [4] | S33682 [4] | — | S33682 [4] | |
| 380–480 | | | — | — | — | — | — | — | S33683 [4] | | |
| AC/DC | | | 48 | — | S29426 [4] | — | S29426 [4] | S29426 [4] | — | — | |
| | | | 100–130 | — | — | — | — | — | — | S33684 [4] | |
| | 200–250 | — | — | — | — | — | — | S33685 [4] | | | |
| 220–240 | — | S29427 [4] | — | S29427 [4] | S29427 [4] | — | — | | | | |

[1] P-frame drawout circuit breaker only.
 [2] Not available on electrically operated P-frame.
 [3] SDE Adapter used for H- and J-frame only.
 [4] Field-installable kit includes time delay module only. Order undervoltage trip separately.

Motor Operators

Motor Operators for H-, J-, and L-Frame Circuit Breakers

- Circuit-breaker indications and information remain visible and accessible, including trip-unit settings and indications
- Suitability for isolation is maintained and padlocking remains possible
- All termination connection (fixed, plug-in/withdrawable) possibilities are maintained
- Double insulation of the front face

| Description | Rated Voltage | Factory Installed Cat. No. Suffix | Field-Installable Kit | | | |
|--|---------------|-----------------------------------|-----------------------|------------------|------------------------|---------|
| | | | H-Frame [5] Cat. No. | J-Frame Cat. No. | L-Frame 600 A Cat. No. | |
|  <p>Standard motor for electrically-operated circuit breakers [6]</p> <p>Communicating motor for electrically-operated circuit breakers [7]</p> <p>Locking device</p> <p>Operations counter</p> <p>Adapter for I-Line circuit breaker</p> | AC | 48-60 | ML | S29440 | S31548 | S432639 |
| | | 110-130 | MA | S29433 | S31540 | S432640 |
| | | 208-277 220-240 | MD | S29434 | S31541 | S432641 |
| | | 380-415 | MF | — | — | S432642 |
| | | 440-480 | MH | S29435 | S31542 | S432647 |
| | | 24-30 | MO | S29436 | S31543 | S432643 |
| | DC | 48-60 | MV | S29437 | S31544 | S432644 |
| | | 110-130 | MR | S29438 | S31545 | S432645 |
| | | 250 | MS | S29439 | S31546 | S432646 |
| | AC | 220-240 | NC | S429441 | S431549 | S432652 |
| | | | Mounting hardware | — | — | S32649 |
| | | | Ronis lock | — | S41940 | S41940 |
| | Profalux lock | — | S42888 | S42888 | S42888 | |
| Mounting hardware plus Ronis lock | | — | S429449 | S429449 | — | |
| Operations counter | — | — | — | S32648 | | |
| Adapter for I-Line circuit breaker | — | — | S37420 | S37420 | — | |

Spring-Charging Motors for Electrically-Operated P-Frame Circuit Breakers

Automatically charges the spring mechanism for closing the P-frame circuit breaker and also recharges the spring mechanism when the circuit breaker is in the ON position. Instantaneous reclosing of the circuit breaker is thus possible following circuit breaker opening.

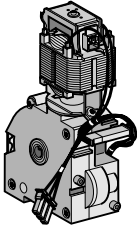
| Description | Rated Voltage | Factory Installed Cat. No. Suffix | P-Frame (For Field Replacement Only) | Replacement Coils | |
|--|---------------|-----------------------------------|--------------------------------------|-------------------------------|--------|
| | | | Spring Charging Motor Cat. No. | Opening/Closing Coil Cat. No. | |
|  <p>Standard motor for electrically-operated circuit breakers. Factory-installed includes motor and opening/closing coils.</p> <p>Communicating motor mechanism for electrically operated circuit breakers. Factory-installed includes motor and opening/closing coils.</p> | AC | 48 | ML | S47391 | S33660 |
| | | 100-130 | MA | S47395 | S33661 |
| | | 220-240 | MC | S47396 | S33662 |
| | | 380-415 | MF | S47398 | S33664 |
| | | 24-30 | MO | S47390 | S33659 |
| | | 48-60 | MV | S47391 | S33660 |
| | DC | 110-130 | MR | S47392 | S33661 |
| | | 200-250 | MS | S47393 | S33662 |
| | | 48 | NL | S47391 | S33034 |
| | AC | 100-130 | NA | S47395 | S33035 |
| | | 220-240 | NC | S47396 | S33036 |
| | | 380-415 | NF | S47398 | S33038 |
| | DC | 24-30 | NO | S47390 | S33033 |
| | | 48-60 | NV | S47391 | S33034 |
| | | 110-130 | NR | S47392 | S33035 |
| | | 200-250 | NS | S47393 | S33036 |

[5] Not available in H-frame 2P modules.

[6] Factory and field-installed standard motor operators for H- and J-frame circuit breakers require the SDE switch and SDE adapter (both included).

[7] Factory and field-installed standard motor operators for L-frame circuit breakers require the SDE switch (included).

[7] Installation requires BSCM Modbus SL/ULP with NSX Cord. For ordering information see page 7-68 .

Rotary Handles

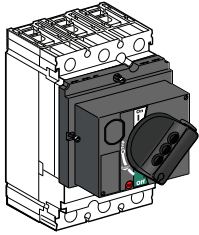

Direct-Mounted Rotary Handle

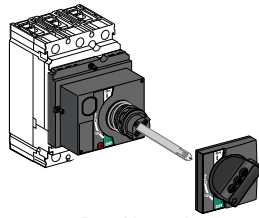

Door-Mounted Rotary Handle

| Device | Description | B-Frame | | H- and J-Frame [8] | | L-Frame | | P-Frame | |
|-------------------------------|-----------------------------|---|----------------------------|-----------------------------------|----------------------------|-----------------------------------|----------------------------|-----------------------------------|------|
| | | Factory Installed Cat. No. Suffix | Field-Installable Cat. No. | Factory Installed Cat. No. Suffix | Field-Installable Cat. No. | Factory Installed Cat. No. Suffix | Field-Installable Cat. No. | Factory Installed Cat. No. Suffix | |
| Direct Mounted | Standard black handle | Operating mechanism kit | RD10 | LV426930 | RD10 | S29337 | RD10 | S32597 | RD10 |
| | Standard black handle with | Two early-break and two early make switches | — | — | — | — | — | — | RD16 |
| | | One early-break switch | — | — | RD12 | S29337 + S29345 | RD12 | S32597 + S32605 | — |
| | | Two early-make switches | — | — | RD13 | S29337 + S29346 | RD13 | S32597 + S29346 | — |
| | Red handle on yellow bezel | Operating mechanism kit | RD20 | LV426931 | RD20 | S29339 | RD20 | S32599 | — |
| | | One early-break switch | — | — | RD22 | S29339 + S29345 | RD22 | S32599 + S32605 | — |
| | | Two early-make switches | — | — | RD23 | S29339 + S29346 | RD23 | S32599 + S29346 | — |
| MCC conversion accessory | — | — | — | S429341 | — | S32606 | — | | |
| CNOMO conversion accessory | — | — | — | 29342 | — | S32602 | — | | |
| Door Mounted | Standard black handle | Operating mechanism kit | — | LV426932 | RE10 | S29338 | RE10 | S32598 | RE10 |
| | Standard black handle with: | Two early-break and two early make switches | — | — | — | — | — | — | RE16 |
| | | Two early make switches | — | — | RE13 | S29338 + S29346 | RE13 | S32598 + S29346 | — |
| Red handle on yellow bezel | Operating mechanism kit | — | LV426933 | RE20 | S29340 | RE20 | S32600 | — | |
| Rotary Handle Replacement Kit | — | — | — | — | — | — | — | S33875 | |
| Telescoping | — | — | — | RT10 | S29343 | RT10 | S32603 | — | |
| Accessories | Key lock adapter | — | — | — | S429344 | — | S32604 | — | |
| | Key locks | Ronis 1351.500 | — | — | — | S41940 | — | S41940 | — |
| | | Profalux KS5 B24 D4Z | — | — | — | S42888 | — | S42888 | — |
| | | 2 Ronis keylocks with 1 key | — | — | — | S41950 | — | S41950 | — |
| | | 2 Profalux keylocks with 1 key | — | — | — | S42878 | — | S42878 | — |
| | Indication Auxiliary Switch | One early-break switch | — | — | — | S29445 | — | S32605 | — |
| Two early-make switches | | — | — | — | S29346 | — | S29346 | — | |

Refer to Digest Section 8—Operating Mechanisms for additional operating mechanism options.

[8] Not available in H-frame 2P modules.

Locks, Installation Accessories, and Rear Connectors

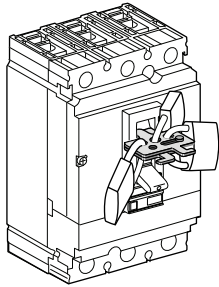

Removable Padlock Attachment

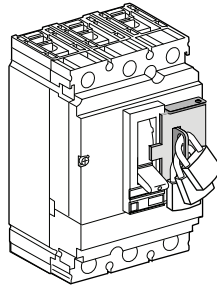

Fixed Padlock Attachment

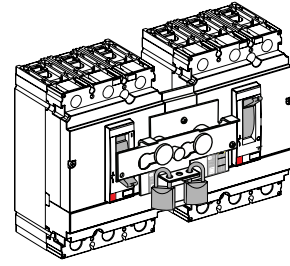

Interlocking with Toggle Control

Table 7.100: Locks, Interlocking

| Device | Description | B- Frame | | H- and J- Frame | | Q- Frame | | L- Frame | M- and P- Frame | | R- Frame | | |
|---|---|-----------------------------------|-------------------------------|-----------------------------------|----------------------------|-----------------------------------|--------------------------|----------------------------|-----------------------------------|--------------------------------|-----------------------------------|----------------------------|---|
| | | Factory-Installed Cat. No. Suffix | Field-Installable Cat. No. | Factory-Installed Cat. No. Suffix | Field-Installable Cat. No. | Factory-Installed Cat. No. Suffix | Field-Installed Cat. No. | Field-Installable Cat. No. | Factory-Installed Cat. No. Suffix | Field-Installable Cat. No. [9] | Factory-Installed Cat. No. Suffix | Field-Installable Cat. No. | |
| Handle Padlocking Device | Removable (lock OFF only) | — | S29370 | — | S29370 | — | — | S29370 | — | S44936 | — | S33996 | |
| | Fixed (lock OFF or ON) | YP | LV426905 LV426907 (I-Line) | YP | HJPA | YP | QBPA | S32631 | YP | S32631 | YP | S32631 | |
| | Fixed (lock OFF only)[10] | YQ | LV426906 LV426908 (I-Line) | YQ | HJPAF | YQ | QBPAF | NJPAF | YQ | MPRPAF | YQ | MPRPAF | |
| | Fixed (lock OFF only)–2P | — | — | YQ | H2PHLA | YQ | — | — | — | — | — | — | |
| Interlocking (Not UL listed) | Mechanical for circuit breakers with rotary handles [11] | — | — | — | S29369 | — | — | S32621 | — | S33890 | — | — | |
| | Mechanical for circuit breakers with toggles [11] | — | LV426909 | — | S29354 | — | QBMIK | S32614 | — | — | — | — | |
| Key Locking | Provision only, vertical mount, 1 or 2 locks | Kirk | — | — | — | — | — | — | JA | — | — | — | |
| | Provisions only, vertical mounting one key interlock including padlock provision, open position only. | Kirk | — | — | — | — | — | — | JE [12] [13] | — | JE [13] | — | |
| | Provision only, horizontal mount 1 lock, M- and P-frame 1 or 2 locks, R-frame | Kirk | — | — | — | — | — | — | — | JK | — | JK | — |
| | | Ronis | — | — | — | — | — | — | — | — | — | JB | — |
| | | Profalux | — | — | — | — | — | — | — | — | — | JD | — |
| | Provision and 1 lock, vertical mount | Kirk | — | — | — | — | — | — | — | JG | — | — | — |
| | | Kirk | — | — | — | — | — | — | — | JL | — | JL | — |
| | | Ronis | — | — | — | — | — | — | — | — | — | JC | — |
| | Provision and 1 lock, horizontal mount | Profalux | — | — | — | — | — | — | — | — | — | JF | — |
| | | Kirk | — | — | — | — | — | — | — | JN | — | JN | — |
| Provision and 2 locks keyed alike | Kirk | — | — | — | — | — | — | — | JN | — | JN | — | |
| Provision and 2 locks keyed differently | Kirk | — | — | — | — | — | — | — | JP | — | JP | — | |

[9] For Drawout breakers use only horizontal keylock. Not available for PowerPac P with motor operator.
 [10] Not available on HD and HG 2P modules.
 [11] Not available in M frame or HD and HG 2P modules.
 [12] Not available on M-frame.
 [13] Not available on I-Line.



Phase Barriers

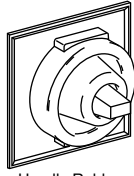

Handle Rubber Boot

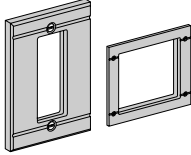

Front Panel Escutcheons



DIN Rail Mounting Kit



Visi-Trip H-, J- Frame



Visi-Trip L- Frame

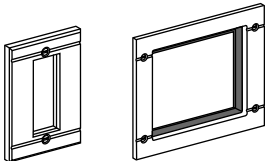

Door Escutcheon

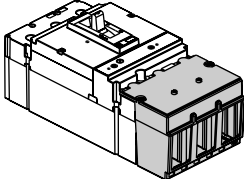

Terminal Covers

Table 7.101: Installation Accessories for B-, H-, J-, and L- Frame Circuit Breakers

| Description | Field-Installable Cat. No. | | |
|--|----------------------------|-----------------|----------|
| | B-Frame | H- and J- Frame | L- Frame |
| Front Panel Escutcheon for Toggle Breakers | — | S29315 | 32556 |
| Front Panel Escutcheon for Rotary Handle, Motor Operator, or extended escutcheon | — | S29317 | S32558 |
| Phase Barriers (set of 6) | LV426920 | S29329 | 32570 |
| Handle Rubber Boot [14] | — | S29319 | S32560 |
| Sealing Accessories (for front cover screws) | S29375 | S29375 | S29375 |
| DIN rail mounting kit (requires 15 mm depth on a 35 mm DIN rail) [14] | Standard | S29305 | — |
| DIN rail adapter | Standard | — | — |
| Handle Extensions (set of 5) | — | S29313 | S432553 |
| Rear Insulation Kit (2P) | LV426921 | — | — |
| Rear Insulation Kit (3P) | LV426922 | — | — |
| Rear Insulation Kit (4P) | LV426923 | — | — |
| Terminal Extensions-Spreaders (3P) | LV426940 | — | — |
| Terminal Extensions-Spreaders (4P) | LV426941 | — | — |
| 5 N-m Torque Limiting Bit, Set of 6 | LV426992 | — | — |
| 5 N-m Torque Limiting Bit, Set of 8 | LV426993 | — | — |
| 9 N-m Torque Limiting Bit, Set of 6 | LV426990 | — | — |
| 9 N-m Torque Limiting Bit, Set of 8 | LV426991 | — | — |
| Visi-Trip qty 1 | — | VTRIPJ | VTRIPL |
| Visi-Trip qty 5 | — | VTRIPJ05 | VTRIPL05 |
| Visi-Trip qty 10 | — | VTRIPJ10 | VTRIPL10 |

Table 7.102: Installation Accessories for M-, P-, and R-Frame Circuit Breakers

| Description | | Frame | Field-Installable Cat. No. |
|--------------------|--------------------|-------------|----------------------------|
| Door Escutcheon | Accessory Cover | M-, P-Frame | S33718 |
| | | R-Frame | S33929 |
| | Toggle Handle | M-, P-Frame | S33717 |
| | Drawout | P-Frame | S33857 |
| Terminal Covers | Short lug cover 3P | P-Frame | S33932 |
| | Short lug cover 4P | | S33933 |
| | Long lug cover 3P | | S33934 |
| | Long lug cover 4P | | S33935 |
| Replacement Handle | Standard | R-Frame | S33997 |
| | Standard Short | M-, P-Frame | S46998 |
| | Long | M-, P-Frame | S46996 |

Table 7.103: H-, J-, and L-Frame Rear Connections

| Device | Description | H-Frame | | | J-Frame | | | L-Frame | | | |
|------------------------|--------------------------------|-----------------------------------|-----------------------------------|----------------------------|-----------|-----------------------------------|----------------------------|-----------|-----------------------------------|----------------------------|------------|
| | | Poles | Factory-Installed Termination No. | Field-Installable Cat. No. | Poles | Factory-Installed Termination No. | Field-Installable Cat. No. | Poles | Factory-Installed Termination No. | Field-Installable Cat. No. | |
| <p>Rear Connection</p> | Mixed Rear Connection Kit [15] | 2 | S | — | 2 | S | — | 3 | S | S32477 | |
| | | 3 | S | S37432 | 3 | S | S37437 | 4 | S | S32478 | |
| | Consisting of: | Short rear connections (set of 2) | 2 or 3 | — | 2x S37433 | 2 or 3 | — | 2x S37438 | 3 | — | 2x S432475 |
| | | Long rear connections (set of 2) | — | S37434 | — | S37439 [16] | — | — | — | 2x S432476 | |
| | | Short terminal cover (3P) | 3 | — | S37436 | 3 | — | S37440 | 3 | — | 2x S32562 |
| | | Short terminal cover (4P) | 4 | — | — | — | — | — | 4 | — | 2x S32563 |

[14] Not available in HD and HG 2P modules.

[15] Kit contains 4 short rear connections, 2 long rear connections (4 long rear connections for 4P), hardware, and 2 terminal covers.

[16] For use with 3P circuit breakers only.

Mechanical Lugs

Table 7.104: Mechanical Lug Kits for B-Frame Circuit Breakers [17]

| Description | Circuit Breaker Application | | | Ampere Rating | Number of Wires Per Lug and Wire Range | Factory-Installed Cat. Suffix | Field-Installable Cat. No. | Qty Per Kit |
|---|-----------------------------|---------------|---------------|---------------|--|-------------------------------|----------------------------|-------------|
| | Standard | Ampere Rating | Optional | | | | | |
| Al Lugs for Use with Al or Cu Wire | | | BD BG BJ | 15-125 A | (1) 14-2/0 AWG Al or Cu | LH | LV426966 | 2 |
| | | | BD BG BJ | 15-125 A | (1) 14-2/0 AWG Al or Cu | LH | LV426967 | 3 |
| Cu Lugs for Use with Cu Wire Only | | | BD BG BJ | 15-125 A | (1) 14-1/0 AWG Cu | LC | LV426964 | 2 |
| | | | BD BG BJ | 15-125 A | (1) 14-1/0 AWG Cu | LC | LV426965 | 3 |
| EverLink Lug | BD BG BJ (1P) | 15 - 125 A | | | (1) 14-3/0 AWG Cu | --- | --- | --- |
| | BD BG BJ (2P) | 15 - 125 A | | | (1) 14-3/0 AWG Cu | --- | --- | --- |
| | BD BG BJ (3P) | 15 - 125 A | | | (1) 14-3/0 AWG Cu | --- | --- | --- |
| | BD BG BJ (4P) | 15 - 125 A | | | (1) 14-3/0 AWG Cu | --- | --- | --- |
| EverLink Lug with Control Wire Terminal | | 15 - 125 A | BD BG BJ (2P) | | (1) 14-3/0 AWG Cu | LU, LV, or LW [18] | LV426973 | 1 |
| | | 15 - 125 A | BD BG BJ (3P) | | (1) 14-3/0 AWG Cu | LU, LV, or LW [18] | LV426974 | 1 |
| | | 15 - 125 A | BD BG BJ (4P) | | (1) 14-3/0 AWG Cu | LU, LV, or LW [18] | LV426975 | 1 |

Table 7.105: Mechanical Lug Kits for H- and J-Frame Circuit Breakers [17]

| Description | Circuit Breaker Application | | | Ampere Rating | Number of Wires Per Lug and Wire Range | Kit Cat. No. | Qty Per Kit |
|---|-----------------------------|---------------|----------------|---------------|--|--------------|-------------|
| | Standard | Ampere Rating | Optional | | | | |
| Al Lugs for Use with Al or Cu Wire | HD, HG, HJ, HL | 15-150 A | | | (1) 14-3/0 AWG Al or Cu | AL150HD | 3 |
| | JD, JG, JJ, JL | 150-175 A | | | (1) 4-4/0 AWG Al or Cu | AL175JD | 3 |
| | JD, JG, JJ, JL | 200-250 A | JD, JG, JJ, JL | 150-175 A | (1) 3/0-350 kcmil Al or Cu | AL250JD | 3 |
| Cu Lugs for Use with Cu Wire Only | | | HD, HG, HJ, HL | 15-150 A | (1) 14-2/0 AWG Cu | CU150HD | 3 |
| | | | JD, JG, JJ, JL | 150-250 A | (1) 1/0-300 kcmil Cu | CU250JD | 3 |
| Control Wire Terminal for H-frame lug kit | | | | | | S37423 | 2 |
| Control Wire Terminal for J-frame lug kit | | | | | | S37424 | 2 |

Table 7.106: Mechanical Lug Kits for L-Frame Circuit Breakers [19]

| Description | Circuit Breaker Application | | | | Number of Wires Per Lug and Wire Range | Kit Cat. No. | Qty Per Kit |
|------------------------------------|-----------------------------|-------|------------|--------|--|------------------------|-------------|
| | Ampere Rating | Poles | Unit Mount | I-Line | | | |
| Al Lugs for Use with Al or Cu Wire | 250 | 3 | X | X | (1) 2 AWG-500 kcmil Al | AL400L61K3 | 3 |
| | | 4 | X | --- | (1) 2 AWG-600 kcmil Cu | AL400L61K4 | 4 |
| | 400/600 | 3 | X | --- | (2) 2/0 AWG-500 kcmil Al or Cu | AL600LS52K3 | 3 |
| | | 4 | X | --- | (2) 2/0 AWG-500 kcmil Al or Cu | AL600LS52K4 | 4 |
| Cu Lugs for Use with Cu Wire Only | 400/600 | 3 | X | X | (2) 3/0 AWG-500 kcmil Al or Cu | AL600LF52K3 | 3 |
| | | 250 | 3 | X | X | (1) 2 AWG-600 kcmil Cu | CU400L61K3 |
| | 400/600 | 4 | X | --- | (1) 2 AWG-600 kcmil Cu | CU400L61K4 | 4 |
| | | 3 | X | --- | (2) 2/0 AWG-500 kcmil Cu | CU600LS52K3 | 3 |
| | 400/600 | 4 | X | --- | (2) 2/0 AWG-500 kcmil Cu | CU600LS52K4 | 4 |
| | | 3 | X | X | (2) 3/0 AWG-500 kcmil Cu | CU600LF52K3 | 3 |

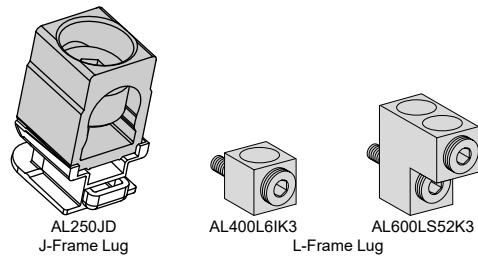
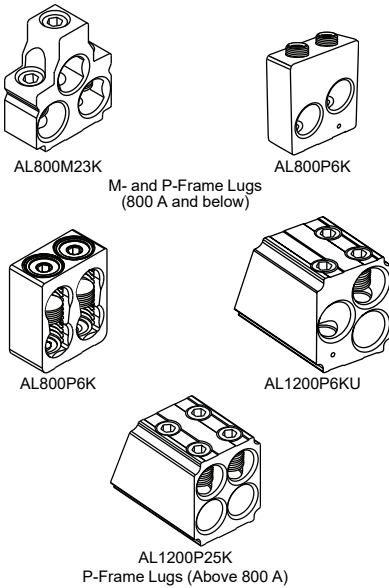

Table 7.107: Mechanical Lug Kits for M-, P- and R-Frame Circuit Breakers [20]

| Description | Circuit Breaker Application | | | | Wires per Lug and Wire Range | Cat. No. | Lugs Per Kit |
|-------------------------------|-----------------------------|------------------------|------------------------|-----------------------|---|---|-----------------|
| | Standard | Rating | Optional | Rating | | | |
| Al Lugs for AL or Cu Wire | M-Frame, P-Frame | 800 A | --- | 800 A | (3) 3/0 AWG-500 kcmil | AL800M23K | 3 |
| | | 1200 A | MG, MJ, PG, PJ, PK, PL | 800 A | (4) 3/0 AWG-500 kcmil | AL1200P24K [21] | 1 |
| | | --- | MG, MJ, PG, PJ, PK, PL | 800 A | (2) 3/0 AWG-600 kcmil | AL800P6K [21] | 3 |
| | | --- | MG, MJ, PG, PJ, PK, PL | 800 A | (2) 3/0 AWG-600 kcmil | AL800P6K4 [21] | 4 |
| | | --- | MG, MJ, PG, PJ, PK, PL | 800 A | (2) 3/0 AWG-750 kcmil 750 kcmil: compact AL only | AL800P7K [21] | 3 |
| | P-Frame | 1200 A | PG, PJ, PK, PL | 800 A | (4) 3/0 AWG-500 kcmil | AL1200P25K [22] | 3 |
| | | --- | PG, PJ, PK, PL | 800 A | (4) 3/0 AWG-500 kcmil | AL1200P25K4 [22] | 4 |
| | | --- | PG, PJ, PK, PL | 800-1200 A | (3) 350-600 kcmil | AL1200P6KU [22] | 3 |
| | | --- | PG, PJ, PK, PL | 800-1200 A | (3) 350-600 kcmil | AL1200P6KU4 [22] | 4 |
| | | PG, PJ, PL | --- | PG, PJ, PK, PL | 1200 A | (3) 3/0 AWG-750 kcmil 750 kcmil: compact AL only | AL1200P7KU [22] |
| R-Frame | 1200 A | I-Line | --- | (4) 3/0 AWG-600 kcmil | AL1200R53K | 1 | |
| | 2500 A | Unit Mount | --- | (1) 3/0 AWG-750 kcmil | AL2500RK [23] | 2 | |
| Cu Lugs for Cu Wire Only [24] | M-Frame, P-Frame | --- | PJ | 100-150 A | (1) 1-1/0 AWG | CU250P1K [25] | 3 |
| | | 800 A | MG, MJ, PG, PJ, PK, PL | --- | (3) 3/0 AWG-500 kcmil | CU800M23K | 3 |
| | 1200 A | MG, MJ, PG, PJ, PK, PL | 800-1200 A | (4) 3/0 AWG-500 kcmil | CU1200P24K [21] | 1 | |
| | P-Frame | 1200 A | PG, PJ, PK, PL | 800-1200 A | (4) 3/0 AWG-500 kcmil | CU1200P25K [26] | 3 |
| | | 1200 A | PG, PJ, PK, PL | 800-1200 A | (4) 3/0 AWG-500 kcmil | CU1200P25K4 | 4 |
| R-Frame | 1200 A | I-Line | --- | (4) 3/0 AWG-500 kcmil | CU1200R53K | 1 | |



[17] For terminal nuts/bus bar connections see page 7-63.

[18] LU = ON end only, LV = OFF end only, LW = BOTH ends

[19] Lug kits for Legacy L-frame circuit breakers can be found in Supplemental Digest Section 11 (i.e. LA, LH circuit breakers).

[20] For lug with a tapped hole for control wire, add a "T" before the "K" in the catalog number (for example, AL800P6TK).

[21] Does not fit onto ON end of unit-mount P-frame circuit breakers.

[22] For unit-mount circuit breaker only.

[23] All unit-mount R-frame circuit breakers require terminal pads for mounting lugs of any type.

[24] Not available with tapped hole for control wire.

[25] This lug can only be used on low amp PJ frame breakers where the Instantaneous setting must not be turned OFF. The cables must be laced with rope per lug instructions.

[26] For unit-mount circuit breaker only.

Compression Lugs

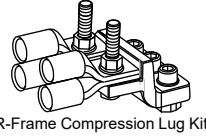
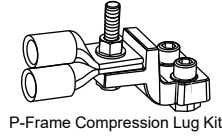
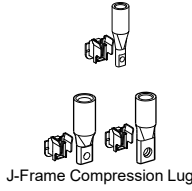

A = Crimp lugs or PDC connectors extension past end of circuit breaker

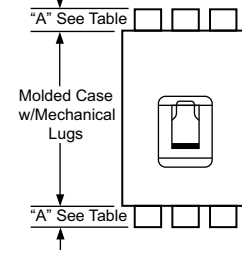

Table 7.108: Compression Lug Kits for PowerPacT™ Circuit Breakers

| Description | Circuit Breaker Type | Ampere Rating | System Range | Mounting Type | Dimension A (in) | Max. Lugs per Terminal | Cat. No. | Qty. Per Kit | | | |
|--|--------------------------------|--|----------------------------------|------------------|------------------|------------------------|------------------|--------------|---|---------|---|
| Compression Lug Kits for B-Frame Circuit Breakers | | | | | | | | | | | |
| Aluminum Compression Lug Kits | B-frame | 125 A | 8-1/0 AWG Al or Cu | Unit/I-line [27] | 1.3 | 1 | LV426988 | 2 | | | |
| | | 125 A | 8-1/0 AWG Al or Cu | | 1.3 | 1 | LV426989 | 3 | | | |
| Copper Compression Lug Kits | B-frame | 125 A | 6-1/0 AWG Cu | | 1.4 | 1 | LV426986 | 2 | | | |
| | | 125 A | 6-1/0 AWG Cu | | 1.4 | 1 | LV426987 | 3 | | | |
| Compression Lug Kits for H-Frame and J-Frame Circuit Breakers | | | | | | | | | | | |
| Aluminum Compression Lug Kits | H-frame | 60 A | 6-2 AWG Al or Cu | Unit/I-line [27] | 1.2 | 1 | YA060HD | 3 | | | |
| | | 150 A | 1/0-4/0 AWG Al or Cu | | 2.5 | 1 | YA150HD | 3 | | | |
| | J-frame | 150 A | 1-3/0 AWG Al or Cu | | 1.2 | 1 | YA150JD | 3 | | | |
| | | 250 A | 3/0-350 kcmil Al or Cu | | 2.5 | 1 | YA250J35 | 3 | | | |
| Copper Compression Lug Kits | H-frame | 60 A | 6-1/0 AWG Cu | | 1.0 | 1 | CYA060HD | 3 | | | |
| | | 150 A | 4-2/0 AWG Cu | | 1.2 | 1 | CYA150HD | 3 | | | |
| | J-frame | 150 A | 6-1/0 AWG Cu | | 0.7 | 1 | CYA150JD | 3 | | | |
| | | 250 A | 2/0-300 kcmil Cu | | 1.1 | 1 | CYA250J3 | 3 | | | |
| Compression Lug Kits for L-Frame Circuit Breakers | | | | | | | | | | | |
| Aluminum Compression Lug Kits | L-frame | 250 A | 4-300 kcmil Al/Cu | Unit/I-line [27] | 1.2 | 1 | YA400L31K3 | 3 | | | |
| | | 400 A | 4-300 kcmil Al/Cu | | 2.5 | 2 | YA600L32K3 | 6 | | | |
| | | 250 A | 2/0-500 kcmil Al/Cu | | 1.2 | 1 | YA400L51K3 | 3 | | | |
| | | 600 A | 2/0-500 kcmil Al/Cu | | 2.5 | 2 | YA600L52K3 | 6 | | | |
| | | 400 A | 500-750 kcmil Al 500 kcmil Cu | | 1.2 | 1 | YA400L71K3 | 3 | | | |
| | | 250 A | 4-300 kcmil Al/Cu | | 2.5 | 1 | YA400L31K4 | 4 | | | |
| | | 400 A | 4-300 kcmil Al/Cu | | 2.5 | 2 | YA600L32K4 | 8 | | | |
| | | 250 A | 2/0-500 kcmil Al/Cu | | 1.2 | 1 | YA400L51K4 | 4 | | | |
| | | 600 A | 2/0-500 kcmil Al/Cu | | 2.5 | 2 | YA600L52K4 | 8 | | | |
| | | 400 A | 500-750 kcmil Al 500 kcmil Cu | | 2.5 | 1 | YA400L71K4 | 4 | | | |
| Copper Compression Lug Kits | L-frame | 250 A | 2/0-300 kcmil Cu | Unit/I-line [27] | 1.2 | 1 | CYA400L31K3 | 3 | | | |
| | | 400 A | 2/0-300 kcmil Cu | | 2.5 | 2 | CYA600L32K3 | 6 | | | |
| | | 250 A | 250-500 kcmil Cu | | 1.2 | 1 | CYA400L51K3 | 3 | | | |
| | | 600 A | 250-500 kcmil Cu | | 2.5 | 2 | CYA600L52K3 | 6 | | | |
| | | 250 A | 2/0-300 kcmil Cu | | 1.2 | 1 | CYA400L31K4 | 4 | | | |
| | | 400 A | 2/0-300 kcmil Cu | | 2.5 | 2 | CYA600L32K4 | 8 | | | |
| | | 250 A | 250-500 kcmil Cu | | 1.2 | 1 | CYA400L51K4 | 4 | | | |
| | | 600 A | 250-500 kcmil Cu | | 2.5 | 2 | CYA600L52K4 | 8 | | | |
| | | Compression Lug Kits for M-Frame, P-Frame, and R-Frame Circuit Breakers | | | | | | | | | |
| | | Aluminum Compression Lug Kits | M-, P-frame | | 250 A | 2/0-300 kcmil | Unit/I-line [27] | 3.7 | 2 | YA250P3 | 1 |
| 300 A | 4/0-500 kcmil | | | 3.9 | 2 | YA300P5 | | 1 | | | |
| 400 A | 2/0-300 kcmil | | | 4.3 | 2 | YA400P3 | | 2 | | | |
| 400 A | 500-750 kcmil Al, 500 kcmil Cu | | | 3.7 | 2 | YA400P7 | | 1 | | | |
| 600 A | 4/0-500 kcmil | | | 3.9 | 2 | YA600P5 | | 2 | | | |
| 800 A | 500-750 kcmil Al, 500 kcmil Cu | | | 4.3 | 2 | YA800P7 | | 2 | | | |
| R-frame [28] | 1200 A | | 2/0-300 kcmil | I-line [27] | 3.8 | 4 | YA1200R3 | 4 | | | |
| | 1200 A | | 4/0-500 kcmil | | 4.0 | 4 | YA1200R5 | 4 | | | |
| | 1200 A | | 500-750 kcmil Al, 500 kcmil Cu | | 4.4 | 4 | YA1200R7 | 4 | | | |
| | 2000 A | | 2/0-300 kcmil | | — [28] | 8 | YA2000R3 | 2 | | | |
| Unit [27] | 2000 A | 4/0-500 kcmil | — [28] | 8 | YA2000R5 | 2 | | | | | |
| | 2500 A | 500-750 kcmil | — [28] | 8 [29] | YA2500R7 | 2 | | | | | |
| | Copper Compression Lug Kits | M-, P-frame | 400 A | 4/0-500 kcmil | Unit [27] | 3.3 | 2 | CYA400P5 | 1 | | |
| | | | 600 A | 4/0-500 kcmil | | 3.3 | 2 | CYA600P5 | 2 | | |
| 800 A | | | 500-750 kcmil | 3.6 | | 2 | CYA800P7 | 2 | | | |
| R-frame | | 1200 A | 4/0-500 kcmil | I-Line [27] | 3.5 | 4 | CYA1200R5 | 4 | | | |
| 1200 A | 500-750 kcmil | 3.8 | 4 | | CYA1200R7 | 4 | | | | | |

[27] Not for use on I-Line™ circuit breakers unless wire bending space is adequate.
 [28] All unit-mount R-frame circuit breakers require terminal pads for mounting lugs of any type.
 [29] 9 lugs for 3000 A circuit breakers



PDC6HD6



PDC6JD4



PDC3HD2



PDC3JD20

Crimp lugs or PDC connectors extension "A" past end of circuit breaker

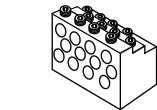
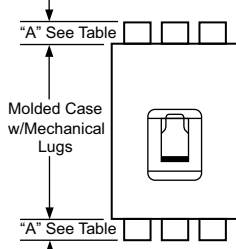

PDC12P4

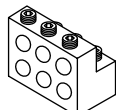

PDC6P20

Power Distribution Connectors

Power distribution connectors (PDCs) can be used for multiple load wire connections on one circuit breaker in place of standard distribution block to save space and time.

The connectors are attached to circuit breaker terminals equipped with separately provided terminal nut connectors. [30]

Applications:

- For use on load end of circuit breaker only
- For use in UL 508 Industrial Control applications
- For use in UL 1995/CSA C22.2 No. 236 heating and cooling equipment
- For copper wire only

Table 7.109: Power Distribution Connectors for B-Frame, H-Frame, J-Frame and L-Frame Circuit Breakers [31]

| Use with Circuit Breaker Type | Ampere Rating | (Wires Per Terminal) Wire Range | Dimension A (in.) | Cat. No. | Qty. Per Kit | Kit Contents |
|-------------------------------|---------------|-----------------------------------|-------------------|------------|--------------|---|
| BD, BG, BJ | 125 A | (3) 14 - 2 AWG | 1.2 | PDC3BD2 | 3 | Mounting hardware, lugs |
| | 125 A | (6) 14 - 6 AWG | 1 | PDC6BD6 | 3 | |
| HD, HG, HJ, HL [32] | 15-150 A | (6) 14-6 AWG Cu | 1.0 | PDC6HD6 | 3 | Mounting hardware, lugs, special purpose label and instructions |
| | 15-150 A | (3) 14-2 AWG Cu | 1.2 | PDC3HD2 | 3 | |
| JD, JG, JJ, JL [32] | 150-250 A | (6) 14-4 AWG Cu | 1.0 | PDC6JD4 | 3 | |
| | 150-250 A | (2) 14-1 AWG and (1) 3-2/0 AWG Cu | 1.5 | PDC3JD20 | 3 | |
| LD, LG, LJ, LL [33] | 150-600 A | (3) 14-1 AWG and (2) 3-2/0 AWG | 1.28 | PDC5DG20L3 | 3 | Mounting hardware, lugs, special purpose label, Medium Terminal Shield and instructions |
| | 150-600 A | (12) 14-4 AWG | 1.31 | PDC12DG4L3 | 3 | Mounting hardware, lugs, special purpose label, Long Terminal Shield and instructions |

Table 7.110: Power Distribution Connectors for M-Frame and P-Frame Circuit Breakers [31]

| | Ampere Rating | (Wires Per Terminal) Wire Range | Cat. No. | Qty Per Kit | Kit Contents |
|--|---------------|---------------------------------|----------|-------------|---|
| Use for multiple load connections on one circuit breaker in place of standard distribution block to save space and time. • Use on load end of circuit breaker only • Use in UL508 Industrial Control applications only. • Use in UL1995/CSA C22.2 No. 236 heating and cooling equipment. • For Cu wire only. | 250-1200 A | (6) 12-2/0 AWG Cu | PDC6P20 | 3 | Mounting hardware, lugs, special purpose label and instructions |
| | | (6) 12-2/0 AWG Cu | PDC6P204 | 4 | Mounting hardware, lugs, special purpose label and instructions |
| | 250-1200 A | (12) 10-4 AWG Cu | PDC12P4 | 3 | Mounting hardware, lugs, special purpose label and instructions |
| | | | PDC12P44 | 4 | Mounting hardware, lugs, special purpose label and instructions |

[30] Refer to Terminal Shields and Phase Barriers.

[31] Not for use with I-Line™ circuit breakers.

[32] Special Purpose—Not for General Use. Use on ON end of the circuit breaker only when ON end is used as Load end. Use on OFF end of the circuit breaker only when OFF end is used as Load end.

[33] Kit includes long terminal shield and cover, which adds 1.65 inches to standard lug with short terminal shield.

Terminal Accessories

Table 7.111: Terminal Nuts for Bus Bar Connection of B-, H- and J-Frame Circuit Breakers

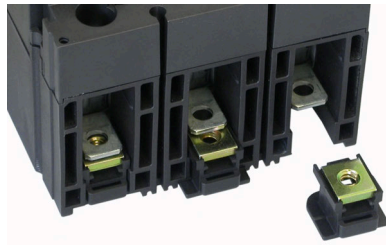

| Description | Frame | Tap | Cat. No. | Qty Per Kit |
|--|---------------|--------|----------|-------------|
| B-Frame Terminal Nut Insert-Metric | BD/BG/BJ (2P) | M6 | LV426962 | 2 |
| B-Frame Terminal Nut Insert-Metric | BD/BG/BJ (3P) | M6 | LV426963 | 3 |
| H-Frame Terminal Nut Insert-English | HD/HG/HJ/HL | 1/4-20 | S37425 | 2 |
| H-Frame Terminal Nut Insert-English | HD/HG/HJ/HL | 1/4-20 | S37444 | 3 |
| H-Frame Terminal Nut Insert-Metric | HD/HG/HJ/HL | M6 | S37426 | 2 |
| J-Frame Terminal Nut Insert-English | JD/JG/JJ/JL | 1/4-20 | S37427 | 2 |
| J-Frame Terminal Nut Insert-English | JD/JG/JJ/JL | 1/4-20 | S37445 | 3 |
| J-Frame Terminal Nut Insert-Metric | JD/JG/JJ/JL | M8 | S37428 | 2 |
| Control Wire Terminal for H-Frame Terminal Nut | HD/HG/HJ/HL | — | S37429 | 2 |
| Control Wire Terminal for J-Frame Terminal Nut | JD/JG/JJ/JL | — | S37430 | 2 |

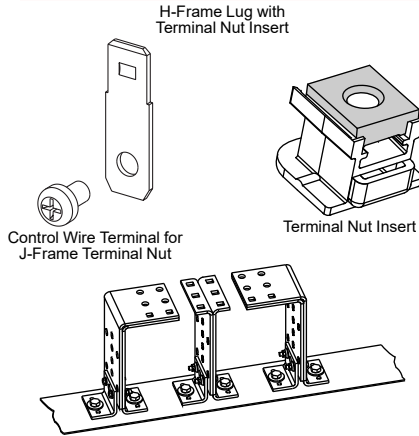

Table 7.112: Bus Bar Connections Hardware for L-, M-, and P-Frame Circuit Breakers

| Frame | Description | Term. No. | Poles | Cat. No. |
|----------------|---|-----------|-------|----------|
| L-Frame | Set of 4 terminal screws and washers for one side | F | 4 | S36967 |
| M- and P-Frame | Bus Connector Kit for one pole, one end | — | 1 | S33928 |

Table 7.113: Terminal Pad Kits for R-Frame Circuit Breakers

| R-Frame Circuit Breaker | Terminal Pad Kit | | Field-Installable Kits | |
|------------------------------------|--------------------------------------|----------------|--------------------------------|--------------------------------|
| | Usage | Lugs per Phase | 3P Kit (One End Only) Cat. No. | 4P Kit (One End Only) Cat. No. |
| 3000 A, 100% Rated [34] | Required for cable or bus | 9 | RL3TB | RL3TB4 |
| 3000 A, Standard (80% Rated) [35] | Required for cable or bus | | | |
| 2500 A, 100% Rated | Required for cable or bus | 8 | RLTB | RLTB4 |
| 2500 A, Standard (80% Rated) | Required for cable, optional for bus | | | |
| All Other R-Frame Circuit Breakers | Required for cable, optional for bus | | | |

For cable connection to RLTB, use AL2500RK lug. See page 7-61.

Table 7.114: Terminal Shields and Phase Barriers

| Used With | Description | | Dimension B (in.) | Cat. No. | Qty Per Kit | | |
|---|-------------------------|---------------------------|-------------------|----------|-------------|---|---|
| | Frame | Max. Wire Size | | | | | |
| H- and J-Frame Mechanical Lugs | Short Lug Shield [36] | H-Frame 60 A | 3 AWG | 0.50 | S37446 | 1 | |
| | | H-Frame 150 A | 3/0 AWG | 0.50 | S37447 | 1 | |
| | | J-Frame | 350 kcmil | 0.24 | S37448 | 1 | |
| | | Compatible with: | | | | | |
| B-, H- and J-Frame Power Distribution Connectors and Compression Lugs | B-Frame Long Lug Shield | PDC3BD2 | L- V426988 | LV426986 | 1.9 | LV426911 (2P) LV426912 (3P) LV426913 (4P) | 1 |
| | | PDC6BD6 | V426989 | LV426987 | | | |
| | H-Frame Long Lug Shield | PDC6HD6 | YA060HD | CYA060HD | 2.24 | S37449 | 1 |
| | | PDC3HD2 | YA150HD | CYA150HD | | | |
| | J-Frame Long Lug Shield | PDC6JD4 | YA150JD | CYA150JD | 1.68 | S37450 | 1 |
| | | PDC3JD2 | [37] | CYA250J3 | | | |
| | L-Frame | 3P Short Terminal Shield | | | LTSS3P | 1 | |
| | | 3P Medium Terminal Shield | | | LTSM3P | 1 | |
| 3P Long Terminal Shield | | | LTSL3P | 1 | | | |
| 4P Medium Terminal Shield | | | LTSM4P | 1 | | | |
| 4P Long Terminal Shield | | | LTSL4P | 1 | | | |
| M-, P-Frame | Phase Barriers | | | S33646 | 3 | | |
| R-Frame | Phase Barriers | | | S33998 | | | |

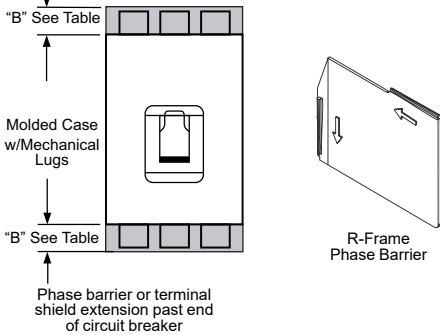

Table 7.115: Miscellaneous H-, J-, and L-Frame Circuit Breaker Accessories

| Accessory | Description | Field-Installable Cat. No. |
|-------------|--|----------------------------|
| Spare Parts | Bag of screws for accessory cover, L-frame | S432552 |
| | 1 spare toggle extension, L-frame | 32595 |
| | Set of 10 identification labels | LV429226 |

[34] 3000 A 80% and 100% rated RL3TP (3P) and RL3TP4 (4P) ship with 2 kits.
 [35] 2500 A 80% and 100% rated RLTB (3P) and RLTB4 (4P) ship with 2 kits.
 [36] Short lug shields provide IP20 protection for mechanical lugs and are compatible with control wire terminals.
 [37] J-frame terminal shield is not compatible with the YA250J35 compression terminal.

Mountings

Table 7.116: Plug-In and Drawout Mountings for H- and J-Frame Circuit Breakers (3P or 2P in a 3P module)



H- and J-Frame Plug-In Mounting



H- and J-Frame Drawout Mounting

| Description | | Factory Installed Cat. No. | Field-Installable Cat. No. | |
|--|---|---|----------------------------|--------|
| Complete Factory-Assembled Circuit Breakers | Plug-in base shipped with circuit breaker | N | — | |
| | Drawout cradle shipped with circuit breaker | D | — | |
| Special Order Options for Plug-In and Drawout Circuit Breakers | Plug-In Base | Circuit breaker Only | HJ00 | |
| | | Plug-in base kit | — | S29278 |
| | Drawout Cradle | Circuit breaker only | HJ00 | — |
| | | Plug-in base kit | — | S29278 |
| | | Cradle side plates (fixed part of chassis) | — | S29282 |
| | | Circuit breaker side plates (moving part of chassis) | — | S29283 |
| Accessories for Plug-In and Drawout | H-Frame Shutter Kit (set of two) | — | S37442 | |
| | J-Frame Shutter Kit (set of two) | — | S37443 | |
| | Secondary Disconnect Blocks | Fixed part 9-wire connector (mounted on base) | — | S29273 |
| | | Moving part 9-wire connector (mounted on circuit breaker) | — | S29274 |
| | | Support for 2-moving connectors | — | S29275 |
| | Extended escutcheon with extended toggle handle | — | S29284 | |
| | Two position indicating switches (connected/disconnected) | — | S29287 | |
| | H-Frame Short Terminal Cover (3P) | — | S37436 | |
| J-Frame Short Terminal Cover (3P) | — | S37440 | | |

Table 7.117: Plug-In and Drawout Mountings for L-Frame Circuit Breakers



L-Frame Plug-In Mounting



L-Frame Drawout Mounting

| Description | Poles | Plug-in Mounting | | Drawout Mounting | | |
|-----------------------------------|-----------------------|----------------------------|----------------------------|----------------------------|----------------------------|--------|
| | | Factory-Installed Cat. No. | Field-Installable Cat. No. | Factory-Installed Cat. No. | Field-Installable Cat. No. | |
| Kit (stationary and moving parts) | 3 | N | — | D | — | |
| | 4 | N | — | D | — | |
| Stationary Part | Plug-in base | 3 | — | S32514 | — | |
| | | 4 | — | S32515 | — | |
| Moving Part | Fixed part of chassis | — | — | — | S32532 | |
| | | — | — | — | S32533 | |
| | Circuit breaker only | — | HJ00 | — | HJ00 | — |
| | | — | — | — | — | S32533 |
| Short terminal covers | 3 | — | 2x S32562 | — | 2x S32562 | |
| | 4 | — | 2x S32563 | — | 2x S32563 | |

Table 7.118: Plug-In and Drawout Accessories for L-Frame Circuit Breakers

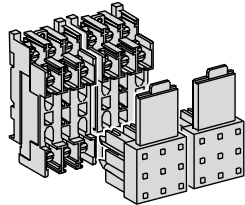

L-Frame Disconnecting Blocks

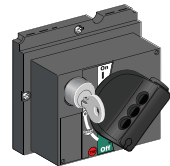

L-Frame Locking Device

| Description | | Field-Installable Cat. No. |
|--------------------------------|---|---------------------------------|
| Secondary Disconnecting Blocks | Fixed Part | 9-wire connector S29273 |
| | Moving Part | 9-wire connector S32523 |
| | | Support for 3 moving connectors |
| Fixed + Moving | 9-wire manual auxiliary connector | S29272 |
| Shutters | Two shutters for plug-in base | 32521 |
| Chassis Accessories | Extended escutcheon for toggle | S32534 |
| | Locking device (key lock is not included) | S29286 |
| | Two position indicating switches (connected/disconnected) | S29287 |

Table 7.119: Termination Options

| Termination Letter | Termination No. |
|--------------------|---|
| N = Plug-in | LGL36400U31X |
| D = Drawout | For factory-installed termination, place termination letter in the third block of the circuit breaker catalog number. |

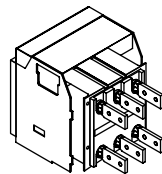
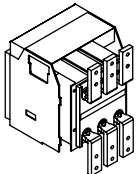

P-Frame Drawout Cradle Connections

Table 7.120: Drawout Cradle and Accessories for P-Frame Circuit Breakers

| Description | | Cat. No. |
|--------------------|--|------------------|
| Drawout Cradle | | Product Selector |
| Cradle Connectors | Front Connected Flat (FCF) | SFCF12 [38] |
| | Rear Connected T Horizontal/Vertical (RCTH/RCTV) | SRCTV12 [38] |
| Cradle Accessories | Modbus™ cradle communication module | S33852 |
| | Safety shutters | S48933 |
| | Secondary disconnects terminal shield | S33763 |
| | Cradle position switch 1a/1b Form C—Connected/test/disconnected | S33170 |
| | Low level cradle position switch 1a/1b Form C—Connected/test/disconnected | S33171 |
| | Cell keying kit | S33767 |
| | Disconnected position key locking—provision for Kirk or Federal Pioneer Lock | S33772 |
| | Door interlock kit | S33786 |
| | Racking interior kit | S33788 |
| | Door escutcheon (for replacement only, included with circuit breaker) | S33857 |
| | Transparent cover | S33859 |
| | Push-in terminal kit (3 wires) | S33098 |
| | Push-in terminal kit (6 wires) | S33099 |
| | Finger cluster | S33166 |
| | Cluster grease (12 oz. tube) | S48899 |

[38] Needs 2 kits per cradle.

PowerPacT H-, J-, and L-Frame MicroLogic Trip Units



MicroLogic Trip Units [1]

MicroLogic Standard 3.2/3.3 Trip Units

PowerPacT™ H-, J-, and L-frame molded case circuit breakers may be specified with any of the following MicroLogic Electronic Trip Units.

- True RMS sensing
- LI, LSI trip configurations
- Field-interchangeable trip units
- LED long-time pickup and trip indication
- Test kits available
- Thermal imaging

MicroLogic Ammeter 5.2A/5.3A/6.2A/6.3A Trip Units

Includes all features listed for MicroLogic standard trip unit, as well as:

- Advanced user interface
- Neutral protection
- Incremental fine tuning of settings
- Up to 12 alarms
- Digital ammeter—phase and neutral (4-pole only)
- Phase loading bar graph
- Maintenance indicators including contact wear, number of operations, operating hours, and load profiles
- Cause of trip information for troubleshooting assistance
- LCD Display
- Zone-selective interlocking (ZSI) (short-time & ground-fault)
- Optional Modbus™ communications—PowerLogic™ compatible

MicroLogic Energy 5.2E/5.3E/6.2E/6.3E Trip Units

Includes all features listed for MicroLogic ammeter trip unit, as well as:

- Ground-fault trip with programmable ground fault alarm (available on 6.2E/6.3E only)
- Power and energy measurement
- Power quality measurements
- Current demand and power demand measurements

PowerPacT H, J and L-Frame MicroLogic Trip Units

Table 7.121: MicroLogic Trip Unit Settings for H-, J-, and L-Frame

| Model | Trip Function | Trip Unit | Ampere Setting |
|--|---------------|-----------|-----------------------------------|
| MicroLogic Trip Unit Settings for H- and J-Frame Circuit Breakers | | | |
| Standard | LI | 3.2 | 15-20-25-30-35-40-45-50-60 |
| | | | 35-40-45-50-60-70-80-90-100 |
| | LSI | 3.2S | 50-60-70-80-90-100-110-125-150 |
| | | | 70-80-100-125-150-175-200-225-250 |
| Ammeter | LSI | 5.2A | 15-20-25-30-35-40-45-50-60 |
| | | | 35-40-45-50-60-70-80-90-100 |
| | LSIG | 6.2A | 50-60-70-80-90-100-110-125-150 |
| | | | 70-80-100-125-150-175-200-225-250 |
| Energy | LSI | 5.2E | 15-60 |
| | | | 35-100 |
| | LSIG | 6.2E | 50-150 |
| | | | 70-250 |
| MicroLogic Trip Unit Settings for L-Frame Circuit Breakers | | | |
| Standard | LI | 3.3 | 125-400 |
| | | | 200-600 |
| | LSI | 3.3S | 125-400 |
| | | | 200-600 |
| Ammeter | LSI | 5.3A | 125-400 |
| | LSIG | 6.3A | 200-600 |
| Energy | LSI | 5.3E | 125-400 |
| | LSIG | 6.3E | 200-600 |

[1] See Supplemental Digest Section 3 for circuit breakers with field-interchangeable trip units.

PowerPacT P- and R-Frame MicroLogic Trip Units

PowerPacT P- and R-Frame MicroLogic Trip Units



Standard Trip Unit

Ammeter Trip Unit

Power Trip Unit

Harmonic Trip Unit

Adjustable Rating Plug

MicroLogic (Standard) 3.0 and 5.0 Trip Units

PowerPacT™ P- and R-frame molded case circuit breakers may be specified with any of the following MicroLogic Electronic Trip Units.

- True RMS sensing
- LI, LSI trip configurations
- Field-interchangeable long-time rating plugs
- LED long-time pickup indication
- Test kits available
- Thermal imaging

MicroLogic (Ammeter) 3.0A, 5.0A and 6.0A Trip Units

Includes all features listed for MicroLogic standard trip unit, as well as:

- LSIG trip configurations
- Digital ammeter—phase and neutral (4-pole only)
- Phase loading bar graph
- LED trip indication
- Zone-selective interlocking (ZSI) (short-time & ground-fault)
- Optional Modbus™ communications—PowerLogic™ compatible

MicroLogic (Power) 5.0P and 6.0P Trip Units

Power measurement and advanced protection features includes all features listed for MicroLogic ammeter trip unit, as well as:

- LSI trip configuration with programmable ground fault alarm
- LSIG (Ground-fault trip) with programmable ground fault alarm
- Incremental “fine tuning” of L, S, I, and G pickup and delay settings
- LCD dot matrix display and LED trip indication
- Advanced user interface
- Advanced protection IDMTL—selectable long-time delay bands
- Neutral protection
- Power measurement
- Contact wear indication
- Modbus communications—PowerLogic compatible
- Local and remote settings

MicroLogic (Harmonic) 5.0H and 6.0H Trip Units

Power quality measurement and advanced protection features. Includes all features listed for the MicroLogic power trip unit, as well as:

- Enhanced power measurements functions
- Power quality measurements

Adjustable Rating Plugs for PowerPacT™ P-Frame and R-Frame and MasterPacT™ NT and NW Circuit Breakers—Selection

To provide maximum design flexibility, system protection, and field upgradeability, each MicroLogic™ trip unit is equipped with an interchangeable long-time rating plug. Each trip unit requires an adjustable rating plug to determine the long-time pickup range of the circuit breaker. These plugs are factory installed on new trip units, or can be ordered separately for field-installable upgrades.

Adjustable rating plugs are offered in eight different ranges of long-time pickup adjustments. The following chart show the ranges of adjustments. Each adjustment times the sensor rating ($I_r \times I_n$) of the circuit breaker sets the long-time pickup value of the circuit breaker.

Table 7.122: PowerPacT P- and R-Frame MicroLogic Trip Unit and Options

| Model | Protection | Additional Features | Field-Installable Cat. No. [2] |
|---------------------|------------|---|--------------------------------|
| 2.0 (IEC only) | LSO | None | S132R |
| 3.0 (UL/ANSI only) | LI | | S131A |
| 5.0 | LSI | | S133A |
| 2.0A (IEC only) | LSO | Ammeter | S142R [3] |
| 3.0A (UL/ANSI only) | LI | | S141A [3] |
| 5.0A | LSI | | S143A [3] |
| 6.0A | LSIG | | S144A [3] |
| 5.0P | LSI | Metering, Adv. Protection | S163A [3][4] |
| 6.0P | LSIG | | S164A [3][4] |
| 5.0H | LSI | Metering, Adv. Protection & Harmonic Analysis | S173A [3][4] |
| 6.0H | LSIG | | S174A [3][4] |

Table 7.123: PowerPacT P- and R-Frame MicroLogic Trip Units
x – Standard Feature o – Available Option

| Features | Standard | | Ammeter | | | Power | | Harmonic | |
|---------------------------------------|----------|-----|---------|------|------|-------|------|----------|------|
| | 3.0 | 5.0 | 3.0A | 5.0A | 6.0A | 5.0P | 6.0P | 5.0H | 6.0H |
| LI | X | — | X | — | — | — | — | — | — |
| LSI (Instantaneous can be turned off) | — | X | — | X | X | X | X | X | X |
| LSIG / Ground-Fault Trip [5] | — | — | — | — | X | — | X | — | X |
| Ground-Fault Alarm (No Trip) [5][6] | — | — | — | — | — | X | — | X | — |
| Ground-Fault Alarm and Trip [5][6] | — | — | — | — | — | — | X | — | X |
| Adjustable Rating Plugs | X | X | X | X | X | X | X | X | X |
| True RMS Sensing | X | X | X | X | X | X | X | X | X |
| UL Listed | X | X | X | X | X | X | X | X | X |
| Thermal Imaging | X | X | X | X | X | X | X | X | X |
| Phase Loading Bar Graph | — | — | X | X | X | X | X | X | X |
| LED for Long-time Pickup | X | X | X | X | X | X | X | X | X |
| LED for Trip Indication | — | — | X | X | X | X | X | X | X |
| Digital Ammeter | — | — | X | X | X | X | X | X | X |
| Zone-selective Interlocking | — | — | X | X | X | X | X | X | X |
| Communications | — | — | X | X | X | X | X | X | X |
| LCD Dot Matrix Display | — | — | — | — | — | X | X | X | X |
| Advanced User Interface | — | — | — | — | — | X | X | X | X |
| Protective Relay Functions | — | — | — | — | — | X | X | X | X |
| Neutral Protection | — | — | — | — | — | X | X | X | X |
| Contact Wear Indication | — | — | — | — | — | X | X | X | X |
| Incremental Fine Tuning of Settings | — | — | — | — | — | X | X | X | X |
| Selectable Long-time Delay Bands | — | — | — | — | — | X | X | X | X |
| Power Measurement | — | — | — | — | — | X | X | X | X |
| Power Quality Measurements | — | — | — | — | — | — | — | X | X |
| Waveform Capture | — | — | — | — | — | — | — | X | X |

Table 7.124: PowerPacT P- and R-Frame Long-Time Pickup Settings

| Rating Plug | Long-time Pickup Settings | | | | | | | | |
|-------------|---------------------------|-----|-----|-----|-----|-----|-----|-----|-----|
| A | .40 | .45 | .50 | .60 | .63 | .70 | .80 | .90 | 1.0 |
| B | .40 | .44 | .50 | .56 | .63 | .75 | .88 | .95 | 1.0 |
| C | .42 | .50 | .53 | .58 | .67 | .75 | .83 | .95 | 1.0 |
| D | .40 | .48 | .64 | .70 | .80 | .90 | .93 | .95 | 1.0 |
| E | .60 | .70 | .75 | .80 | .85 | .90 | .93 | .95 | 1.0 |
| F | .84 | .86 | .88 | .90 | .92 | .94 | .96 | .98 | 1.0 |
| G | .66 | .68 | .70 | .72 | .74 | .76 | .78 | .80 | .82 |
| H | .48 | .50 | .52 | .54 | .56 | .58 | .60 | .62 | .64 |

Table 7.125: Special Options

| Description | Factory-Installed Suffix | Field-Installable Cat. No. |
|---|--------------------------|----------------------------|
| Ship circuit breaker in closed position | YK | N/A |
| Alternate Maintenance Setting (AMS) kit (use with 5.0/6.0 A, P or H and 5.3/6.3 A or E MicroLogic trip units) | — | 84957 |
| Energy Reduction Maintenance Setting (ERMS) kit (use with 5.0/6.0 P or H MicroLogic trip units) | — | 84956 |
| Maintenance Mode Setting Switch kit | 120 Vac | LV429659 |
| | 24 Vdc | LV429658 |

[2] The standard rating plug supplied with a trip unit will be the "A" rating plug. To specify an alternative adjustable rating plug, please add the letter designation to the end of the catalog number. Please refer to page 7-68 for a complete listing of adjustable settings available with each plug. (Example: S143B would specify a "B" rating plug instead of the standard "A" plug.) Use suffix "N" if no rating plug is required, deduct.

[3] When replacing a standard trip unit with Type A (Ammeter), P (Power metering) or H (Harmonic analysis) trip unit, order the 12-pin connector kit S33101 for the MasterPacT NW and NT and the PowerPacT P-frame drawout circuit breakers or kit S33100 for PowerPacT P-frame and R-frame unit-mount and I-Line circuit breakers.

[4] Requires Circuit Breaker Communications Module.

[5] Requires neutral current transformer in 3Ø4W systems.

[6] Alarm history is available through the trip unit display and communications. Local indication of an alarm requires an M2C Programmable Contact Module.

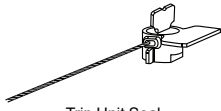

Trip Unit Seal



Sensor Plug

Trip Unit Accessories

Adjustable rating plug "A" is installed as standard on all MicroLogic trip unit orders. However, an alternative selection may be specified from the "Assembled" table below, and factory installed with your trip unit order at no additional charge. To order, please attach the appropriate catalog suffix to the end of the trip unit Cat. No. (after specifying trip unit options). Adjustable rating plugs may also be purchased as field-installable components from the table below.

For Enerlin'X accessory information, see [Enerlin'X Digital Solutions, page 7-79](#)

Table 7.126: Rating Plugs

| Rating Plug [7] | Factory Installed Cat. Suffix | Field-Installable Cat. No. |
|-----------------|-------------------------------|----------------------------|
| A | A (standard) | S48818 |
| B | B | S48819 |
| C | C | S48820 |
| D | D | S48836 |
| E | E | S48837 |
| F | F | S48838 |
| G | G | S48839 |
| H | H | S48840 |

Table 7.127: Neutral Current Transformers

| Use With | Cat. No. | Sensor |
|----------|-----------|----------|
| H- Frame | S429521 | 60–100 |
| | S430562 | 150 |
| J- Frame | S430563 | 250 |
| L- Frame | S432575 | 400–600 |
| P- Frame | S33575[8] | 250 |
| | S33576[8] | 400–1600 |
| R- Frame | S48916[8] | 250 |
| | S34036[8] | 400–1600 |
| | S48896[8] | 2000 |
| | S48182[8] | 3000 |
| All | NCTWIRING | All |

Table 7.128: Zone-Selective Interlocking

| Description | Factory-Installed Cat. Suffix | Field-Installable Cat. No. |
|-----------------------------|-------------------------------|----------------------------|
| ZSI Interface Module | — | S434212 |
| 24 Vdc Terminal Block | EN | S434210 |
| ZSI Wire Harness, H/J Frame | YH3 | S434300 |
| ZSI Wire Harness, L- Frame | YH3 | S434301 |
| ENCT & ZSI Wire Harness | YH4 | — |

Table 7.130: Sensor Plugs for P- and R- Frame Circuit Breakers [10]

| Description | Sensor Plug Range | Sensor Plug Cat. No. | Circuit Breaker Frames Accepting Sensor Plug | | | | | | | | | |
|---------------------------------|-------------------|----------------------|--|-------|-------|------------|-------|--------|--------|-------------|--------|---|
| | | | 250 A | 400 A | 600 A | 630 A [11] | 800 A | 1000 A | 1200 A | 1250 A [11] | 1600 A | |
| P- Frame Circuit Breaker | | | | | | | | | | | | |
| UL | 250 A | S47052 | X | — | — | — | — | — | — | — | — | — |
| | 400 A | S47053 | — | X | X | — | X | — | — | — | — | — |
| | 600 A | S48823 | — | — | X | — | X | X | X | — | — | — |
| | 800 A | S33092 | — | — | — | — | X | X | X | — | — | — |
| | 1000 A | S33093 | — | — | — | — | — | X | X | — | — | — |
| | 1200 A | S48824 | — | — | — | — | — | — | X | — | — | — |
| IEC | 630 A | S33091 | — | — | — | X | X | X | — | X | X | X |
| | 800 A | S33092 | — | — | — | — | X | X | — | X | X | X |
| | 1000 A | S33093 | — | — | — | — | — | X | — | X | X | X |
| | 1250 A | S33094 | — | — | — | — | — | — | — | X | X | X |
| | 1600 A | S33095 | — | — | — | — | — | — | — | — | — | X |
| R- Frame Circuit Breaker | | | | | | | | | | | | |
| UL | 600 A | S48823 | X | X | X | X | — | — | — | — | — | — |
| | 800 A | S33092 | — | X | X | X | X | — | — | — | — | — |
| | 1000 A | S33093 | — | — | X | X | X | X | — | — | — | — |
| | 1200 A | S48824 | — | — | — | X | X | X | X | — | — | — |
| | 1600 A | S33095 | — | — | — | — | X | X | X | X | — | — |
| | 2000 A | S33982 | — | — | — | — | — | X | X | X | — | — |
| | 2500 A | S33983 | — | — | — | — | — | — | X | X | — | — |
| | 3000 A | S48825 | — | — | — | — | — | — | — | X | — | — |
| | 3200 A | S33984 | — | — | — | — | — | — | — | — | — | X |
| IEC | 1600 A | S33095 | — | — | — | — | X | X | X | X | X | X |
| | 2000 A | S33982 | — | — | — | — | — | X | X | X | X | X |
| | 2500 A | S33983 | — | — | — | — | — | — | X | X | X | X |
| | 3200 A | S33984 | — | — | — | — | — | — | — | — | — | X |

[7] Long-time pickup amperes (Ir) = Sensor Rating (In) X Setting of rating plug. "Fine adjustment tuning" is included on MicroLogic Power and Harmonic trip units, allowing for incremental settings of 1 A between the plug setting and .40 X Sensor Rating.

[8] Includes NCTWIRING kit.

[9] Service Interface Test Kit can be ordered through SE Services only. Service Interface Test kit replaces obsolete UTA, Hand-Held and Full Function Test Kit.

[10] For use only with circuit breakers with date codes later than 07011. For long-time pickup range, See rating plug information at page 7-65.

[11] IEC Only.

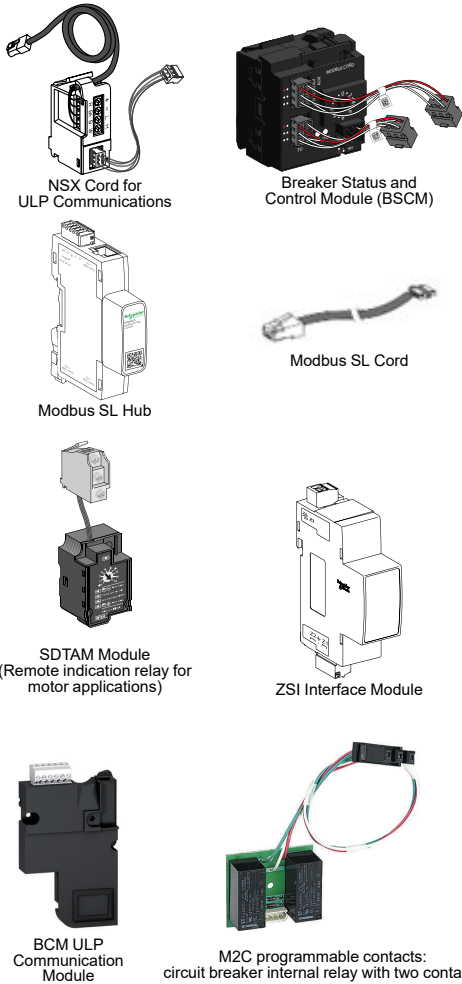

Table 7.131: Electronic Trip Unit Accessories, Wire Harness [12] and ULP Cords for H-, J-, and L- Frame Circuit Breakers [13]

| Description | Factory-Installed Cat. No. Suffix | Field-Installable Kit Cat. No. | |
|--|-----------------------------------|--------------------------------|-----------|
| | | H-, J-, and L- Frame | L- Frame |
| NSX Cord [14] (for ULP Communication) | L = 1.3 m (4.27 ft) | EA | S434201 |
| | L = 3 m (9.84 ft) | EB | S434202 |
| BSCM (Breaker Status and Control Module) with NSX ULP Cord V, <= 480 Vac [14] | L = 1.3 m (4.27 ft) | EG [15] | S434201BX |
| | L = 3 m (9.84 ft) | EH [15] | S434202BX |
| Replacement BSCM for Modbus SL or ULP | — | — | S434220 |
| BSCM with NSX ULP Cord for V > 480 Vac [14] | L = 1.3 m (4.27 ft) | EK [15] | S434204BX |
| | L = 3 m (9.84 ft) | EL [15] | S434303BX |
| BSCM with MB SL Cord for V <= 480 Vac [16] | L = 3.0 m (9.84 ft) | EP | S434223BX |
| | L = 1.3 m (4.27 ft) | ER | S434222BX |
| | L = 0.35 m (1.15 ft) | ES | S434221BX |
| Modbus SL Hub for Daisy chain, 3x RJ45 connections, DIN rail mount, stacking connector compatible [16] | — | — | S434224 |
| SDTAM 24/415 Vac/dc Module [17] | V | — | S429424 |
| SDX Module 24/415 Vac/dc [18] | V | — | S429532 |
| ZSI Wire Harness, H/J Frame | YH3 | — | S434300 |
| ZSI Wire Harness, L- Frame | YH3 | — | S434301 |
| ENCT Wire Harness | YH2 | — | S434302 |
| OF Wire Harness | YH1 | — | S434500 |
| SD/SDE Wire Harness | YH1 | — | S434501 |
| SDx/SDTAM Wire Harness | YH1 | — | S434502 |
| MN Wire Harness | YH1 | — | P434503 |
| MX Wire Harness | YH1 | — | P434504 |
| 24 Vdc Terminal Block Wire Harness [19] | YH1 | — | S434505 |
| Motor Operator Wire Harness | YH1 | — | S434506 |
| Communicating Motor Operator Wire Harness | YH1 | — | S434507 |
| NSX Wire Harness [19] | YH1 | — | S434508 |

Table 7.132: Trip Unit Field-Installable Accessories for P- and R-Frame Circuit Breakers

| Description | Factory-Installed Cat. No. Suffix | Field-Installable Kit Cat. No. | | | | | | |
|---|-----------------------------------|--------------------------------|--------|----------------|---------|--------------------|------------|--------|
| | | P- Frame | | | | | R- Frame | |
| | | Unit Mount | I-Line | Motor Operated | Drawout | With Rotary Handle | Unit Mount | I-Line |
| Breaker Communication Module (BCM ULP) | E1 | S64205 | S64205 | S64207 | S64206 | S64205 | S64205 | S64205 |
| Replacement BCM ULP | — | 33106 | 33106 | 33106 | 33106 | 33106 | 33106 | 33106 |
| Two Programmable Contacts Module (M2C) [20] | V | S64273 | S64273 | S64273 | S64273 | S64273 | S64273 | S64273 |
| External Voltage Sensing (EVS) | YV | S64203 | S64203 | S64210 | S64209 | S64210 | S64208 | S64208 |

Table 7.133: Trip Unit Field-Installable Accessories for MasterPact NT/NW Circuit Breakers

| Description | Factory-Installed Cat. No. Suffix | Field-Installable Kit Cat. No. | | | |
|---|-----------------------------------|--------------------------------|---------|---------------|---------|
| | | MasterPact NT | | MasterPact NW | |
| | | Fixed | Drawout | Fixed | Drawout |
| Breaker Communication Module (BCM ULP) | — | S48188 | S47485 | S47405 | S48384 |
| Replacement BCM ULP | — | 33106 | 33106 | 33106 | 33106 |
| Two Programmable Contacts Module (M2C) [20] | — | S47403 | S47485 | S47403 | S48382 |
| External Voltage Sensing (EVS) | — | S47506 | S47507 | S47506 | S48533 |

[12] Wire harness is required for I-Line applications, optional for unit-mount applications

YH1 = all installed accessories but ZSI and ENCT

YH2 = ENCT and all installed accessories

YH3 = ZSI and all installed accessories

YH4 = ZSI, ENCT and all installed accessories

[13] For proper selection, see catalog 0611CT1001.

[14] Installation requires IFM (LV434000) for Modbus communication and/or FDM (STRV00121) for external display.

[15] If using with motor operator requires communicating motor operator (suffix NC).

[16] Modbus serial only <= 480Vac. Use only with matching Modbus serial components.

[17] Remote indication relay for motor applications

[18] Remote indication relay

[19] I-Line wire harness is included for communication network accessories.

[20] Compatible with MicroLogic P and H only.

New!

MasterPac MTZ Circuit Breakers

MasterPac MTZ continues the performance and reliability of the MasterPac line. MasterPac MTZ circuit breakers bring innovation and upgradability throughout the entire lifecycle, for improved power uptime, business performance, and cost control.

- Customize MicroLogic X control unit anytime
- Purchase optional Digital Modules for additional protection, measurement and maintenance & diagnostic
- Easy installation using established architectures
- Demonstrated compliance with standards
- Smartphone connectivity for wireless alerts and maintenance
- Built in power meter with Class 1 precision for smart energy metering



MasterPac MTZ2
800–4000 A

Table 7.134: MasterPac MTZ1 Circuit Breaker Ratings

| Standard Frame Rating Interrupting Code | | ANSI C37 Certified/ UL 1066 Listed | | UL 489 Listed | | | | | | | | | | | | |
|--|---------|---------------------------------------|----|--|-----|--------|-----|------------|----|-----|-----|------------|--------|----|-----|-----|
| | | 800 A | | 800 A | | | | 1200 A | | | | 1600 A [1] | | | | |
| | | N1 | N | N | H | L1 | L | LF [2] | N | H | L1 | L | LF [2] | N | H | L1 |
| Interrupting Current (kA RMS) 50/60 Hz | 240 Vac | 42 | 50 | 65 | 100 | 200 | 200 | 50 | 65 | 100 | 200 | 200 | 50 | 65 | 100 | 200 |
| | 480 Vac | 42 | 50 | 50 | 65 | 100 | 100 | 50 | 50 | 65 | 100 | 100 | 50 | 50 | 65 | 100 |
| | 600 Vac | — | 35 | 50 | — | — | — | 35 | 50 | — | — | — | 35 | 50 | N/A | N/A |
| Short-time Withstand Current (kA RMS) | | 42 | 35 | 35 | 10 | 10 | 10 | 35 | 35 | 10 | 10 | 10 | 35 | 35 | 10 | 10 |
| Built-in Instantaneous Override (kA RMS ±10%) | | — | 40 | 40 | 10 | 10 | 10 | 40 | 40 | 10 | 10 | 10 | 40 | 40 | 10 | 10 |
| Close and latch rating (kA RMS) | | 40 | 25 | 25 | 10 | 10 | 10 | 25 | 25 | 10 | 10 | 10 | 25 | 25 | 10 | 10 |
| Tested to show the arc flash hazard risk category as referenced by NFPA70E | | — | — | — | — | — | Yes | — | — | — | — | Yes | — | — | — | — |
| Breaking time | | 25–30 ms with no intentional delay | | 25–30 ms with no intentional delay (9 ms for L and LF) | | | | | | | | | | | | |
| Closing time | | < 50 ms | | | | | | | | | | | | | | |
| Sensor Rating | | 400–800 A | | 400–800 A | | | | 600–1200 A | | | | 800–1600 A | | | | |
| Endurance Rating (C/O Cycles) With No Maintenance | | Mechanical | | 12,500 | | 12,500 | | 12,500 | | | | 12,500 | | | | |
| | | Electrical | | 2800 | | 2800 | | 2800 | | | | 2800 | | | | |

Table 7.135: MasterPac MTZ2 and MTZ3 Circuit Breaker Ratings

| Standard Frame Rating Interrupting Code | | ANSI C37 Certified/UL 1066 Listed | | | | | | | | | | | | | | UL 489 Listed | | | | | | | | | | | |
|--|---------|---|----|----|------|--------|---------|-----------|----|-----|--------|-----------------|----|----|-----|------------------------|----|-----|--------|--|-----|------------------------|--------|-------------------------------------|-------|-------|-------|
| | | 800–1600 A | | | | | | 2000 A | | | | 3200/4000 A [3] | | | | 4000/5000 A | | | | 800/1200/1600/2000 A | | 2500/3000 A | | 4000/5000/6000 A | | | |
| | | N1 | H1 | H2 | H3 | L1 [2] | L1F [2] | H1 | H2 | H3 | L1 [2] | L1F [2] | H1 | H2 | H3 | L1 [2] | H2 | H3 | L1 [2] | N | H | L [2] | LF [2] | H | L [2] | H | L [2] |
| Interrupting Current (kA RMS) 50/60 Hz | 240 Vac | 42 | 65 | 85 | 10-0 | 200 | 200 | 65 | 85 | 100 | 200 | 200 | 65 | 85 | 100 | 200 | 85 | 100 | 200 | 65 | 100 | 200 | 200 | 100 | 200 | 100 | 200 |
| | 480 Vac | 42 | 65 | 85 | 10-0 | 200 | 200 | 65 | 85 | 100 | 200 | 200 | 65 | 85 | 100 | 200 | 85 | 100 | 200 | 65 | 100 | 150 | 150 | 100 | 150 | 100 | 150 |
| | 600 Vac | 42 | 65 | 85 | 85 | 130 | 130 | 65 | 85 | 85 | 130 | 130 | 65 | 85 | 85 | 130 | 85 | 85 | 130 | 50 | 85 | 100 | 100 | 85 | 100 | 85 | 100 |
| Short-time Withstand Current (kA RMS) | | 42 | 65 | 85 | 85 | 30 | 22 | 65 | 85 | 85 | 30 | 22 | 65 | 85 | 85 | 100 | 85 | 85 | 100 | 42 | 65 | 30 [4] | 22 | 65 | 65 | 85 | 100 |
| Built-in Instantaneous Override (kA RMS ±10%) | | 35 | 35 | 35 | 85 | 35 | 24 | — | — | 85 | 35 | 24 | — | — | 85 | 117 | — | — | 117 | 40 | 40 | 35 [4] | 24 | 65 | 65 | 75 | 75 |
| Close and latch rating (kA RMS) | | 42 | 65 | 40 | 40 | 25 | 22 | 65 | 40 | 40 | 25 | 22 | 65 | 40 | 40 | 40 | 85 | 75 | 40 | 40 | 40 | 25 [5] | 22 | 40 | 40 | 40 | 40 |
| Tested to show arc flash hazard risk category as referenced by NFPA70E | | — | — | — | — | — | Yes | — | — | — | — | Yes | — | — | — | — | — | — | — | — | — | — | Yes | — | — | — | — |
| Breaking time | | 25–30 ms with no intentional delay (9 ms for L1, L1F, L and LF) | | | | | | | | | | | | | | | | | | | | | | | | | |
| Closing time | | 70 ms | | | | | | | | | | | | | | | | | | | | | | | | | |
| Sensor Rating (A) | | 400–800 800–1600 | | | | | | 1000–2000 | | | | 1600–3200 | | | | 2000–4000 2500–5000 | | | | 400–800 600–1200 800–1600 1000–2000 | | 1200–2500 1600–3000 | | 2000–4000 2500–5000 3000–6000 | | | |
| Endurance Rating (C/O Cycles) With No Maintenance | Mech. | 12,500 | | | | | | 10,000 | | | | 10,000 | | | | 5k | | | | 5,000 | | 12,500 [6] | | 10,000 | | 5,000 | |
| | Elec. | 2800 | | | | | | 1,000 | | | | 1,000 | | | | 1k | | | | 1,000 | | 2800 [6] | | 1,000 | | 1,000 | |

[1] Fixed mounted only.
 [2] Drawout mounted only.
 [3] 4000 A standard width circuit breaker is not available in L1 interrupting rating code or drawout construction (fixed mounting only).
 [4] 65 kA RMS for 2000 A.
 [5] 40 kA RMS for 2000 A.
 [6] For 2000 A N/H/L/LF devices, the endurance rating is 10,000 for mechanical and 1000 for electric.

7 MINIATURE AND MOLDED CASE CIRCUIT BREAKERS

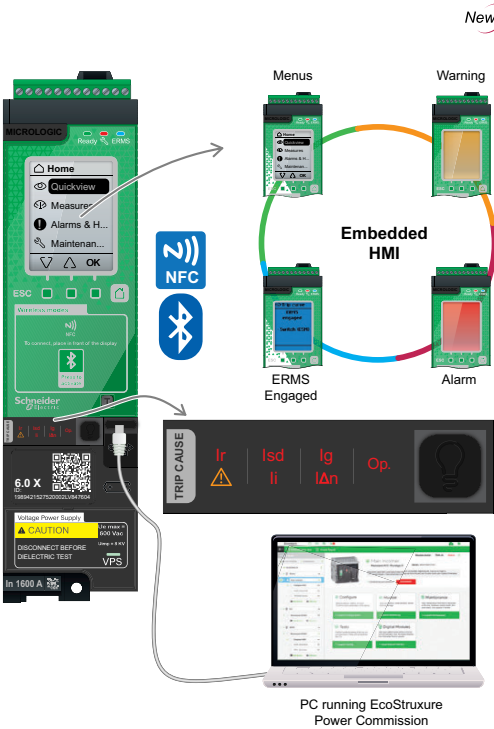

New!

MicroLogic X Control Unit for MasterPacT MTZ Circuit Breakers

The MicroLogic X control unit protection functions include overcurrent, short-circuit, and ground-fault protection. Along with the standard protection functions LI, LSI, and LSIg, new features enhance the overall performance of a system: dual settings, fine settings, fast tripping.

MicroLogic X measures electrical parameters of a power system: currents, voltages, frequency, power, energy, power factor, current and power demand. Min/Max and average values are calculated for most of the parameters.

MicroLogic X capability for maintenance & diagnostics simplifies circuit breaker service and operations. Relevant indicators and messages are powerful tools that can help the user scheduling both preventive and predictive maintenance, and device replacement.

MasterPacT MTZ Digital Modules Options for Advanced Functions

Optional Digital Modules can be purchased and downloaded to enhance the performance of MicroLogic X control units. They are dedicated to advanced protection, measurement, and maintenance & diagnostics, and are available through Go Digital on the Schneider Electric website.

| Module (Available on the Schneider Electric GoDigital Website) | | Part Number |
|--|--|-------------|
| Protection | | |
| ANSI 27/59—Under/Over Voltage Protection | Monitors the circuit breaker voltages and trips when the voltage exceeds the settings. | LV850012 |
| ANSI 32P—Reverse Active Power Protection | Monitors the active power. | LV850011 |
| ANSI 51N/51G—Ground-Fault Alarm | Provides an integrated ground fault alarm. | LV850007 |
| ERMS—Energy Reducing Maintenance Settings | Used to lower the protection settings in order for the MasterPacT MTZ circuit breaker to trip faster, reducing arc energy. | LV850009 |
| Metering | | |
| Energy per Phase Digital Module | Calculates and displays the active, reactive and apparent energy per phase of the power system and provides total active, reactive and apparent energy per phase. | LV850002 |
| Individual Harmonics Analysis | Provide harmonics of voltage and current to the 40th harmonic. | LV850006 |
| Maintenance & Diagnostic | | |
| Power Restoration Assistant, | Displays available circuit breaker information to help determine potential causes of an event and also provides guidance for potential solutions to restore power. | LV850004 |
| MasterPacT Operation Assistant | Assists in closing or opening the circuit breaker remotely with Bluetooth by delivering applicable instructions. Requires Comm & Diag accessories. | LV850005 |
| Waveform Capture on Trip Event | Automatically logs five cycles of phase and neutral currents. | LV850003 |
| Modbus Legacy Dataset | Allows easy integration in existing Modbus installations where modification of supervision software for MTZ circuit breakers is not desired. | LV850045 |

New generation MicroLogic X control units incorporate wireless technology (Bluetooth and NFC) that allows the transfer of a wide selection of critical information (protection, measurements, maintenance & diagnostics) to your mobile device, by means of the EcoStruxure Power Device App.

Alternatively, MasterPacT MTZ can be equipped with ETHERNET communication through either the IFE module or the new embedded EIFE that includes webpages. Modbus SL communication is available through the IFM interface module.

MicroLogic X Sensor Plugs

Table 7.136: Sensor Plug

| In (A) | Sensor Plug : | MTZ1-08 MTZ2-08 | MTZ2-16 | MTZ2-16 | MTZ2-32 | MTZ2-40 | MTZ3-32 | MTZ3-40 | MTZ3-50 | MTZ3-60 | MTZ3-63 |
|--------|---------------|--------------------|---------|---------|---------|---------|---------|---------|---------|---------|---------|
| 400 | LV847053SP | X | — | — | — | — | — | — | — | — | — |
| 600 | LV848823SP | X | — | — | — | — | — | — | — | — | — |
| 630 | LV833091SP | X | X | — | — | — | — | — | — | — | — |
| 800 | LV833092SP | X | X | — | — | — | — | — | — | — | — |
| 1000 | LV833093SP | — | X | X | — | — | — | — | — | — | — |
| 1200 | LV848824SP | — | X | X | — | — | — | — | — | — | — |
| 1250 | LV833094SP | — | X | X | — | — | — | — | — | — | — |
| 1600 | LV833095SP | — | X | X | X | — | — | — | — | — | — |
| 2000 | LV833982SP | — | — | X | X | X | X | X | X | X | X |
| 2500 | LV833983SP | — | — | — | X | X | X | X | X | X | X |
| 3000 | LV848825SP | — | — | — | X | X | X | X | X | X | X |
| 3200 | LV833984SP | — | — | — | X | X | X | X | X | X | X |
| 3600 | LV836390SP | — | — | — | — | X | X | X | X | X | X |
| 4000 | LV836391SP | — | — | — | — | X | X | X | X | X | X |
| 2000 | LV847821SP | — | — | — | — | — | X | X | — | — | — |
| 2500 | LV847822SP | — | — | — | — | — | X | X | X | — | — |
| 3000 | LV848826SP | — | — | — | — | — | X | X | X | X | — |
| 3200 | LV847823SP | — | — | — | — | — | X | X | X | X | X |
| 3600 | LV836391SP | — | — | — | — | — | — | X | X | X | X |
| 4000 | LV847824SP | — | — | — | — | — | — | X | X | X | X |
| 5000 | LV847825SP | — | — | — | — | — | — | — | X | X | X |
| 6000 | LV848827SP | — | — | — | — | — | — | — | — | X | X |
| 6300 | LV847826SP | — | — | — | — | — | — | — | — | — | X |

Table 7.137: Replacement Parts for MicroLogic X Control Units

| Replacement Part | Part Number |
|---|-------------|
| MicroLogic X Embedded Display & Wireless Card | LV850054SP |
| Internal Battery | LV833593SP |
| Transparent Cover with No Access Holes to MicroLogic X Control Unit | LV839454SP |
| Transparent Cover with Access Holes to MicroLogic X Control Unit | LV839453SP |
| USB Cable (miniUSB/USB) for MicroLogic X Control Unit | LV850067SP |

New!

MasterPac MTZ Accessories

Table 7.138: MasterPac MTZ Circuit Breaker Accessories

| Accessory | Circuit Breaker | Version | |
|---|-----------------|---------|---------|
| | | Fixed | Drawout |
| Connection | | | |
| Horizontal and vertical rear connection | MTZ1/2/3 | X | X |
| Front connection | MTZ1/2/3 | X | X |
| Vertical-connection adapters | MTZ1 | X | X |
| Cable-lug adapters | MTZ1 | X | X |
| Spreaders | MTZ1 | X | X |
| Disconnectable front connection adapter | MTZ2/3 | X | — |
| Lugs for 240 mm ² or 300 mm ² cables | MTZ1 | X | X |
| Interphase barriers | MTZ1/2/3 | X | X |
| Arc chute cover (CC) | MTZ1 | X | — |
| Brackets for mounting | MTZ2/3 | X | — |
| Signalling | | | |
| ON/OFF indication contacts (OF) | MTZ1/2/3 | X | X |
| Fault-trip indication contact (SDE) | MTZ1/2/3 | X | X |
| Combined connected/closed contacts (EF) | MTZ2/3 | — | X |
| Cradle switches (CE, CD, CT) | MTZ1/2/3 | — | X |
| Ready-to-close contact (PF) | MTZ1/2/3 | X | X |
| ERMS switch module (ESM) | MTZ1/2/3 | X | X |
| Mechanical operation counter (CDM) | MTZ1/2/3 | X | X |
| Controlling | | | |
| Diagnostic and communicating shunt close (XF diag&com) | MTZ1/2/3 | X | X |
| Shunt close (XF) | MTZ1/2/3 | X | X |
| Diagnostic and communicating shunt trip (MX diag&com) | MTZ1/2/3 | X | X |
| Shunt trip (MX) | MTZ1/2/3 | X | X |
| Diagnostic undervoltage release (MN diag) | MTZ1/2/3 | X | X |
| Undervoltage release (MN) | MTZ1/2/3 | X | X |
| Non-adjustable delay unit (R) | MTZ1/2/3 | X | X |
| Adjustable delay unit (Rr) | MTZ1/2/3 | X | X |
| Isolation module | MTZ1/2/3 | X | X |
| Spring charging motor (MCH) | MTZ1/2/3 | X | X |
| Electrical reset option (RES) | MTZ1/2/3 | X | X |
| Automatic reset option (RAR) | MTZ1/2/3 | X | X |
| Electrical closing pushbutton (BPFE) | MTZ1/2/3 | X | X |
| Locking and Interlocking | | | |
| ON/OFF pushbutton locking (VBP) | MTZ1/2/3 | X | X |
| OFF position locking (VSPO-VCPO) | MTZ1/2/3 | X | X |
| Cradle locking in disconnected position by padlock | MTZ1/2/3 | — | X |
| Cradle locking in disconnected position: by keylock (VSPD) | MTZ1/2/3 | — | X |
| Optional connected/disconnected/test position locking | MTZ1/2/3 | — | X |
| Safety shutters (VO) | MTZ1/2/3 | — | X |
| Shutter position indication and locking (VIVC) | MTZ2/3 | — | X |
| Cable-type door interlock (IPA) | MTZ1/2/3 | X | X |
| Door interlock (VPEC) | MTZ1/2/3 | — | X |
| Racking interlock (VPOC) | MTZ1/2/3 | — | X |
| Racking interlock between crank and OFF pushbutton (IBPO) | MTZ2/3 | — | X |
| Cradle rejection kit | MTZ1/2/3 | — | X |
| Circuit Protection | | | |
| External sensor for ground-fault protection (ENCT) | MTZ1/2/3 | X | X |
| External sensor for source ground-return (SGR) protection | MTZ1/2/3 | X | X |
| Operation Protection | | | |
| Automatic spring discharge before circuit breaker removal (DAE) | MTZ2/3 | — | X |
| Grounding kit (KMT) | MTZ2/3 | X | X |
| Mechanical Protection | | | |
| Terminal cover (CB) | MTZ1/2/3 | — | X |
| Escutcheon (CDP) | MTZ1/2/3 | X | X |
| Blanking plate for escutcheon (OP) | MTZ1/2/3 | X | X |
| Transparent cover for escutcheon (CP) | MTZ1/2/3 | — | X |
| Power Supplies | | | |
| Voltage power supply (VPS) | MTZ1/2/3 | X | X |
| External 24 Vdc power supply module (AD) | MTZ1/2/3 | X | X |
| Battery module (BAT) | MTZ1/2/3 | X | X |
| Mobile Power Pack by APC | MTZ1/2/3 | X | X |
| Spare internal battery | MTZ1/2/3 | X | X |



Microswitch Type ON/OFF Indication Contacts (OF) (MTZ1)

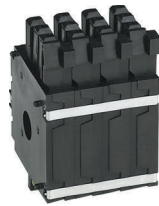

Rotary Type ON/OFF Indication Contacts (OF) (MTZ2 and MTZ3)

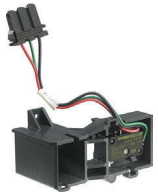

Additional Overcurrent Trip Indication Contacts (SDE)



Combined Connected/Closed Contacts



Connected / Disconnected / Test Position Cradle Switches (CE, CD and CT)

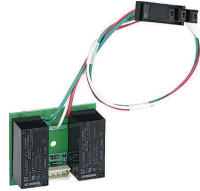

M2C programmable contacts: circuit breaker internal relay with two contacts

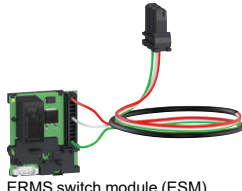

ERMS switch module (ESM)



Ready-to-close contacts (PF)



Pushbutton locking (VBP) with padlock



Grounding Kit (KMT)

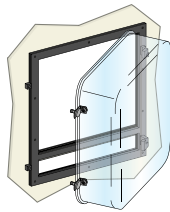

Transparent Cover for Escutcheon (CCP)

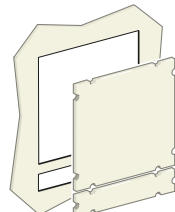

Cover for Escutcheon (CCP)

Communication Accessories
Table 7.139: Monitoring and Control



EIFE Embedded Ethernet Interface



IO Application Module



IFE Interface



IFE Switchboard Server

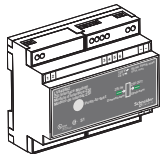

ZSI Interface Module

| Description | Catalog Number | |
|-------------------------|--|------------|
| Enerlin'X modules | EIFE Embedded Ethernet module full kit includes EIFE and EIFE cable; for MTZ1-drawout | LV851100SP |
| | EIFE Embedded Ethernet module full kit includes EIFE actuators and EIFE cable; for MTZ2/3-drawout | LV851200SP |
| | EIFE Embedded Ethernet stand-alone module; for MTZ1/2/3-drawout | LV851001SP |
| | Ethernet interface LV breaker | LV434001 |
| | Ethernet interface for LV breakers and gateway | LV434002 |
| | I/O application module | LV434063 |
| | EIFE Cable; for MTZ1-drawout | LV851120SP |
| ULP port modules | EIFE Cable; for MTZ2/3-drawout | LV851220SP |
| | ULP port - for MasterPacT MTZ1 - fixed | LV850063SP |
| | ULP port - for MasterPacT MTZ1 - drawout | LV850064SP |
| | ULP port - for MasterPacT MTZ2/3 - fixed | LV850061SP |
| Ethernet display module | ULP port - for MasterPacT MTZ2/3 - drawout | LV850062SP |
| | Front display module FDM128 | LV434128 |
| ULP Wiring Accessories | 5 RJ45 connectors female/female | TRV00870 |
| | 10 ULP line terminators | TRV00880 |
| | 10 RJ45/RJ45 male cord L = 0.3 m | TRV00803 |
| | 10 RJ45/RJ45 male cord L = 0.6 m | TRV00806 |
| | 5 RJ45/RJ45 male cord L = 1 m | TRV00810 |
| | 5 RJ45/RJ45 male cord L = 2 m | TRV00820 |
| | 5 RJ45/RJ45 male cord L = 3 m | TRV00830 |
| ZSI Interface Module | 1 RJ45/RJ45 male cord L = 5 m | TRV00850 |
| | Connects up to 15 PowerPacT H/J/L/P/R or MasterPacT MTZ/NT/NW Circuit Breakers or for applications requiring compliance with IEC and CENELEC HD 60364-4-41 or those requiring double insulation. | LV848892SP |

Auxiliary, Alarm Contacts and Power Supply Catalog Numbers

Combined Contacts

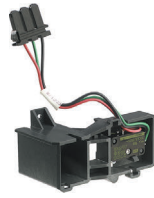
 Additional Overcurrent Trip Indication
 Contacts (SDE)

 Microswitch Type ON/OFF Indication Contacts
 (OF) (MTZ1)

 MasterPacT Electrical Closing Pushbutton
 (BPFE)

Table 7.140: Auxiliary and Alarm Contacts, Programmable Contact Module, Electrical Close Pushbutton

| Accessory | Catalog Number | |
|---|----------------|------------|
| | MTZ1 | MTZ2/MTZ3 |
| 1a/1b Form C Auxiliary Switch | LV847076SP | — |
| Low Level 1a/1b Form C Auxiliary Switch | LV847077SP | — |
| 4a/4b Form C Auxiliary Switch (OF) | — | LV864922SP |
| 1a/1b Form C Connected/Closed Switch (EF) | — | LV848477SP |
| Low Level 1a/1b Form C Connected/Closed Switch (EF) | — | LV848478SP |
| 1a/1b Form C Second Trip Alarm Switch (SDE2) | LV847915SP | LV847915SP |
| Low Level 1a/1b Form C Second Trip Alarm Switch | LV847916SP | LV847916SP |
| 1a/1b Form C Ready-to-Close Switch (PF) | LV847080SP | LV847080SP |
| Low Level 1a/1b Form C Ready-to-Close Switch | LV847081SP | LV847081SP |
| Electrical Close Pushbutton (BPFE) | LV864917SP | LV848534SP |

Table 7.141: Cradle Position Switches (Cell Switches)

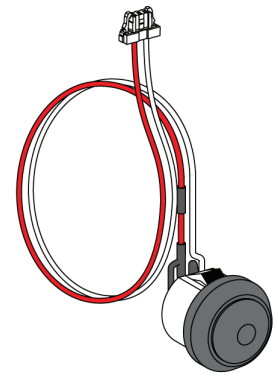
| Description | Catalog Number |
|--|----------------|
| 1a/1b Form C Connected/Test/Disconnected Switch | LV833170SP |
| Low Level 1a/1b Form C Connected/Test/Disconnected Switch | LV833171SP |
| 1a Connected/Test/Disconnected Switch MTZ2-3 (Ring Tongue) | LV839289SP |
| 1b Connected/Test/Disconnected Switch MTZ2-3 (Ring Tongue) | LV839290SP |
| Set of 3 Cell Switch Actuating Arms | LV848560SP |

NOTE: Auxiliary, alarm and status switches' terminal blocks need to be ordered separately, see Secondary Terminal Block Kits, below.

Table 7.142: Secondary Terminal Block Kits

| Description | Fixed MTZ1/2/3 | Drawout MTZ1 | Drawout Drawout MTZ2/3 |
|--------------------------------|----------------|--------------|------------------------|
| Push-in Terminal kit (3 Wires) | LV847074SP | LV833098SP | LV847849SP |
| Push-in Terminal kit (6 Wires) | LV847075SP | LV833099SP | LV847850SP |
| Ring Tongue Kit 1a MTZ2-3 | — | — | LV839296SP |
| Ring Tongue Kit 1b MTZ2-3 | — | — | LV839297SP |
| Ring Tongue Kit 1a & 1b MTZ2-3 | — | — | LV839298SP |

Table 7.143: Accessories for MicroLogic X Control Units

| Description | Voltage | Catalog Number |
|-----------------------------------|-------------|----------------|
| External power supply module (AD) | 24–30 Vdc | LV454440 |
| | 48–60 Vdc | LV454441 |
| | 100–125 Vdc | LV454442 |
| | 110–130 Vdc | LV454443 |
| | 200–240 Vdc | LV454444 |

Vigirex™ Ground-Fault Relay System

The Vigirex ground-fault relays, with associated sensors (current transformers), measure the residual current in an electrical installation to detect levels which may be damaging. When used for protection, they cause an associated circuit breaker or switch to interrupt the supply of power to the protected system. They may also be used for monitoring only, with output to an alarm. The product line includes fixed sensitivities from 30 mA to 1 A and adjustable sensitivities up to 30 A.

The Vigirex relays may be easily mounted on DIN rail or may be panel mounted in a meter cutout. Sensors for conductors range from a little more than an inch diameter toroids, to large rectangular sensors measuring 6 x 18 inches. The compact size of the relay and its sensor make it ideal for protection of OEM equipment as well as branch circuits.



Table 7.144: Vigirex Ground-Fault Relays (UL 1053 Listed)

| Model | Delay | Reset | Control Voltage | Sensitivity | Cat. No. | |
|-------------------------|---|-------------|---|---|-------------------------|-------|
| DIN Rail Mounted | | | | | | |
| RH10M | Instantaneous | Manual | 12–24 Vac/12–48 Vdc | 30 mA | 56300 | |
| | | | | 100 mA | 56302 | |
| | | | | 300 mA | 56305 | |
| | | | | 500 mA | 56306 | |
| | | | | 1 A | 56307 | |
| | | | | 30 mA | 56320 | |
| | | | 110–130 Vac | 100 mA | 56322 | |
| | | | | 300 mA | 56325 | |
| | | | | 500 mA | 56326 | |
| | | | | 1 A | 56327 | |
| | | | | 220–240 Vac | 30 mA | 56330 |
| | | | | | 100 mA | 56332 |
| 300 mA | 56335 | | | | | |
| 500 mA | 56336 | | | | | |
| 1 A | 56337 | | | | | |
| | | | | | | |
| RH21M | Instantaneous or 60 msec (2 settings) | Manual | 12–24 Vac/12–48 Vdc 110–130 Vac 220–240 Vac | 30 mA [7] or 300 mA (2 settings) | 56360 56362 56363 | |
| RH99M | Adjustable (9 settings): 0, 0.06, 0.15, 0.23, 0.31, 0.5, 0.8, 1.0, 4.5 sec | Manual | 12–24 Vac/12–48 Vdc | Adjustable, (9 settings): 0.03 [7], 0.1, 0.3, 0.5, 1, 3, 5, 10, 30 A | 56370TD | |
| | | | 110–130 Vac | | 56372TD | |
| | | 220–240 Vac | 56373TD | | | |
| | | Automatic | 12–24 Vac/12–48 Vdc | | 56390TD | |
| | | | 110–130 Vac | | 56392TD | |
| | | | 220–240 Vac | | 56393TD | |
| Panel Mounted | | | | | | |
| RH10P | Instantaneous | Manual | 12–24 Vac/12–48 Vdc | 30 mA | 56400 | |
| | | | | 100 mA | 56402 | |
| | | | | 300 mA | 56405 | |
| | | | | 500 mA | 56406 | |
| | | | | 1 Amp | 56407 | |
| | | | | 30 mA | 56420 | |
| | | | 110–130 Vac | 100 mA | 56422 | |
| | | | | 300 mA | 56425 | |
| | | | | 500 mA | 56426 | |
| | | | | 1 Amp | 56427 | |
| | | | | 220–240 Vac | 30 mA | 56430 |
| | | | | | 100 mA | 56432 |
| 300 mA | 56435 | | | | | |
| 500 mA | 56436 | | | | | |
| 1 A | 56437 | | | | | |
| | | | | | | |
| RH21P | Instantaneous or 60 msec (2 settings) | Manual | 12–24 Vac/12–48 Vdc 110–130 Vac 220–240 Vac | 30 mA [7] or 300 mA (2 settings) | 56460 56462 56463 | |
| RH99P | Adjustable (9 settings): 0, 0.06, 0.15, 0.23, 0.31, 0.5, 0.8, 1.0, 4.5 sec | Manual | 12–24 Vac/12–48 Vdc | Adjustable (9 settings): 0.03 [7], 0.1, 0.3, 0.5, 1, 3, 5, 10, 30 A | 56470TD | |
| | | | 110–130 Vac | | 56472TD | |
| | | 220–240 Vac | 56473TD | | | |
| | | Automatic | 12–24 Vac/12–48 Vdc | | 56490TD | |
| | | | 110–130 Vac | | 56492TD | |
| | | | 220–240 Vac | | 56493TD | |

Table 7.145: Sensors for Vigirex Ground-Fault Relays

| Sensors | Type | Maximum Current [8] | Inside Diameter | | Cat. No. |
|--------------------------------------|-----------|---------------------|-----------------|-----------|----------|
| | | | in. | mm | |
| Closed Toroids, Type A | TA30 | 65 A | 1.18 | 30 | 50437 |
| | PA50 | 85 A | 1.97 | 50 | 50438 |
| | IA80 | 160 A | 3.15 | 80 | 50439 |
| | MA120 | 250 A | 4.72 | 120 | 50440 |
| | SA200 | 400 A | 7.87 | 200 | 50441 |
| | GA300 | 630 A | 11.81 | 300 | 50442 |
| Vigirex Sensor Iron Rings (Optional) | TA30 | 65 A | 0.79 | 20 | 56055 |
| | PA50 | 85 A | 1.58 | 40 | 56056 |
| | IA80 | 160 A | 2.76 | 70 | 56057 |
| | MA120 | 250 A | 4.33 | 110 | 56058 |
| Split toroids, Type TOA | TOA80 | 160 A | 3.15 | 80 | 50420 |
| | TOA120 | 250 A | 4.73 | 120 | 50421 |
| Rectangular Sensors | 280 x 115 | 1600 A | 11.02 x 4.53 | 280 x 115 | 56053 |
| | 470 x 160 | 3200 A | 18.50 x 6.30 | 470 x 160 | 56054 |



7 MINIATURE AND MOLDED CASE CIRCUIT BREAKERS

[7] 30 mA is instantaneous only, except for RH99M and RH99P models. Their suffix TD indicates time delay at 30 mA. For models with no time delay (IEC compliant) consult catalog 0972CT0401.

[8] Use as a guideline for sizing wire through sensor.

MasterPacT NT and NW Circuit Breakers

The MasterPacT NT and NW universal power circuit breakers offer a family of circuit protection products meeting the most common world standards, ANSI, UL and IEC. The basic design platform for each is common. The final result is UL, ANSI and IEC circuit breakers with the same basic external dimensions, features and accessories.

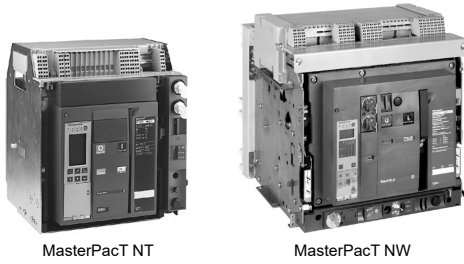

- Complete product offering up to 200 k AIR without fuses
- Circuit breakers tested to show arc flash hazard risk category as referenced by NFPA70E
- 800 A to 6000 A frames, fixed and draw-out
- Rated for AC voltage systems through 600 V (635 V ANSI)
- Short-time withstand ratings up to 100 kA
- Cradle position indicator: connected, test and disconnected
- Simple, visual contact wear indicators
- Full complement of field-installable accessories common to all standards
- Four interchangeable MicroLogic trip units to choose from
- Available PowerLogic™ based power metering and monitoring capabilities
- Available protective relay functions as defined by ANSI C37.2 and C37.90

The following charts show the MasterPacT NW and NT ratings for ANSI and UL 489. See the Catalog 0613CT0001.

Table 7.146: MasterPacT NW Circuit Breaker Ratings

| Standard Frame Rating Interrupting Code | ANSI C37 Certified/UL 1066 Listed | | | | | | | | | | | | | | | | | | UL 489 Listed | | | | | | | | | | | | | |
|--|---|---------|---------|----|---------|----------|-------------|--------|----|---------|----------|-----|-----------------|--------|---------|-----|----|---------|----------------------------|---------|---------|---------|----------------------|--------|---|--------|-------------|--|----------------------------|--|---|--|
| | 800–1600 A | | | | | | 2000 A | | | | | | 3200/4000 A [9] | | | | | | 4000/5000 A | | | | 800/1200/1600/2000 A | | | | 2500/3000 A | | 4000/5000/6000 A | | | |
| | N1 | H1 | H2 | H3 | L1 [10] | L1F [10] | H1 | H2 | H3 | L1 [10] | L1F [10] | H1 | H2 | H3 | L1 [10] | H2 | H3 | L1 [10] | N | H | L [10] | LF [10] | H | L [10] | H | L [10] | | | | | | |
| Interrupting Current (kA RMS) 50/60 Hz | 240 Vac | 42 | 65 | 85 | 100 | 200 | 200 | 65 | 85 | 100 | 200 | 200 | 65 | 85 | 100 | 200 | 85 | 100 | 200 | 65 | 100 | 200 | 200 | 100 | 200 | 100 | 200 | | | | | |
| | 480 Vac | 42 | 65 | 85 | 100 | 200 | 200 | 65 | 85 | 100 | 200 | 200 | 65 | 85 | 100 | 200 | 85 | 100 | 200 | 65 | 100 | 150 | 150 | 100 | 150 | 100 | 150 | | | | | |
| | 600 Vac | 42 | 65 | 85 | 85 | 130 | 130 | 65 | 85 | 85 | 130 | 130 | 65 | 85 | 85 | 130 | 85 | 85 | 130 | 50 | 85 | 100 | 100 | 85 | 100 | 85 | 100 | | | | | |
| Short-time Withstand Current (kA RMS) | 42 | 65 | 85 | 85 | 30 | 22 | 65 | 85 | 85 | 30 | 22 | 65 | 85 | 85 | 100 | 85 | 85 | 100 | 42 [11] | 65 [11] | 30 [11] | 22 [12] | 22 | 65 | 65 | 85 | 100 | | | | | |
| Built-in Instantaneous Override (kA RMS ±10%) | 35 [13] | 35 [13] | 35 [13] | 85 | 35 [13] | 24 | — | — | 85 | 35 | 24 | — | — | 85 | 117 | — | — | 117 | 40 | 40 | 35 [11] | 24 [14] | 24 | 65 | 65 | 75 | 75 | | | | | |
| Close and latch rating (kA RMS) | 42 | 65 | 40 | 40 | 25 | 22 | 65 | 40 | 40 | 25 | 22 | 65 | 40 | 40 | 40 | 85 | 75 | 40 | 40 | 40 | 25 [15] | 22 | 40 | 40 | 40 | 40 | 40 | | | | | |
| Tested to show arc flash hazard risk category as referenced by NFPA70E | — | — | — | — | — | Yes | — | — | — | — | Yes | — | — | — | — | — | — | — | — | — | — | Yes | — | — | — | — | — | | | | | |
| Breaking time | 25–30 ms with no intentional delay (9 ms for L1, L1F, L and LF) | | | | | | | | | | | | | | | | | | | | | | | | | | | | | | | |
| Closing time | 70 ms | | | | | | | | | | | | | | | | | | | | | | | | | | | | | | | |
| Sensor Rating | 100–250 A 400–800 A 800–1600 A | | | | | | 1000–2000 A | | | | | | 1600–3200 A | | | | | | 2000–4000 A 2500–5000 A | | | | | | 100–250 A 400–800 A 600–1200 A 800–1600 A 1000–2000 A | | | | 1200–2500 A 1600–3000 A | | 2000–4000 A 2500–5000 A 3000–6000 A | |
| Endurance Rating (C/O Cycles) With No Maintenance | Mechanical | 12,500 | | | | | | 10,000 | | | | | | 10,000 | | | | | | 5k | 5,000 | | | | 12,500 [16] | | | | 10,000 | | 5,000 | |
| | Electrical | 2800 | | | | | | 1,000 | | | | | | 1,000 | | | | | | 1k | 1,000 | | | | 2800 [16] | | | | 1,000 | | 1,000 | |

[9] 4000 A standard width circuit breaker is not available in L1 interrupting rating code or drawout construction (fixed mounting only).
 [10] Drawout mounted only.
 [11] 24 kA RMS for 800 A circuit breaker frame with 100 A or 250 A sensor.
 [12] 65 kA RMS for 2000 A.
 [13] None except 24 kA RMS for 800 A circuit breaker frame with 100 A or 250 A sensor.
 [14] 65 kA RMS for 2000 A.
 [15] 40 kA RMS for 2000 A.
 [16] The endurance rating for 2000 A, N/H/L/LF is 10,000 for mechanical and 1000 for electrical.

Table 7.147: MasterPacT NT Circuit Breaker Ratings

| Standard Frame Rating Interrupting Code | | ANSI C37 Certified/ UL 1066 Listed | UL 489 Listed | | | | | | | | | | | | | |
|--|------------|---------------------------------------|--|----|-----|-----|---------|------------|----|-----|-----|---------|-------------|----|-----|-----|
| | | 800 A | 800 A | | | | | 1200 A | | | | | 1600 A [17] | | | |
| | | N1 | N | H | L1 | L | LF [18] | N | H | L1 | L | LF [18] | N | H | L1 | L |
| Interrupting Current (kA RMS) 50/60 Hz | 240 Vac | 42 | 50 | 65 | 100 | 200 | 200 | 50 | 65 | 100 | 200 | 200 | 50 | 65 | 100 | 200 |
| | 480 Vac | 42 | 50 | 50 | 65 | 100 | 100 | 50 | 50 | 65 | 100 | 100 | 50 | 50 | 65 | 100 |
| | 600 Vac | — | 35 | 50 | — | — | — | 35 | 50 | — | — | — | 35 | 50 | N/A | N/A |
| Short-time Withstand Current (kA RMS) | | 42 | 35 | 35 | 10 | 10 | 10 | 35 | 35 | 10 | 10 | 10 | 35 | 35 | 10 | 10 |
| Built-in Instantaneous Override (kA RMS ±10%) | | — | 40 | 40 | 10 | 10 | 10 | 40 | 40 | 10 | 10 | 10 | 40 | 40 | 10 | 10 |
| Close and latch rating (kA RMS) | | 40 | 25 | 25 | 10 | 10 | 10 | 25 | 25 | 10 | 10 | 10 | 25 | 25 | 10 | 10 |
| Tested to show the arc flash hazard risk category as referenced by NFPA70E | | — | — | — | — | — | Yes | — | — | — | — | Yes | — | — | — | — |
| Breaking time | | 25–30 ms with no intentional delay | 25–30 ms with no intentional delay (9 ms for L and LF) | | | | | | | | | | | | | |
| Closing time | | < 50 ms | | | | | | | | | | | | | | |
| Sensor Rating | | 100–250 A | 100–250 A | | | | | 600–1200 A | | | | | 800–1600 A | | | |
| | | 400–800 A | 400–800 A | | | | | — | | | | | — | | | |
| Endurance Rating (C/O Cycles) With No Maintenance | Mechanical | 12,500 | 12,500 | | | | | 12,500 | | | | | 12,500 | | | |
| | Electrical | 2800 | 2800 | | | | | 2800 | | | | | 2800 | | | |



NWMPRR

Table 7.148: MasterPacT NW/NT Circuit Breaker Remote Racking

| Description | Cat. No. |
|--|------------|
| MasterPacT NW/NT/MTZ1/2/3 Remote Racking Devices [19] | LV839291SP |
| MasterPacT NW/MTZ2/3 Remote Racking Device [19] | LV839292SP |
| MasterPacT NT/MTZ1 Remote Racking Device [19] | LV839293SP |
| Mounting Bracket Kit for NW/MTZ2/3 Remote Racking (contains 10 mounting brackets) [20] | LV839294SP |
| Mounting Bracket Kit for NT/MTZ1 Remote Racking (contains 10 mounting brackets) [20] | LV839295SP |
| Control Unit for NW/NT/MTZ1/2/3 Remote Racking [20] | S47101 |
| 30 ft Control Cable for NW/NT/MTZ1/2/3 Remote Racking [20] | S47102 |
| Drive Shaft for NW/MTZ2/3 Remote Racking [20] | S47103 |
| Drive Shaft for NT/MTZ1 Remote Racking [20] | S47105 |

[17] Fixed mounted only.
 [18] Drawout mounted only.
 [19] Unit comes with 10 mounting brackets included.
 [20] For replacement only.

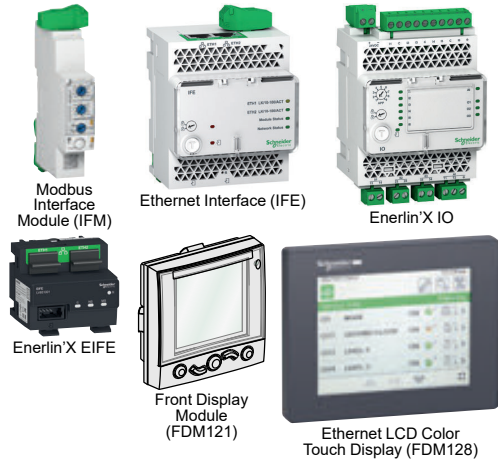

Enerlin'X System for MicroLogic Trip Units

Enerlin'X Systems enable network connectivity for MasterPacT and PowerPacT circuit breakers to provide remote monitoring, control & alarming features which is central to the Smart Systems Architecture with Square D low voltage distribution equipment.

Enerlin'X interface modules support Smart System Applications by facilitating access to circuit breaker data that provides performance information, circuit breaker status, metering measurements and various maintenance alert indicators such as contact wear, operation counters, load profile etc.

Table 7.149: Communications and IO Interface Modules and Front Display Screens for MasterPacT MTZ/NT/NW and PowerPacT H/J/L/P/R Circuit Breakers

| Description | Part Number |
|--|-------------|
| IFM Modbus-SL Interface for LV Circuit Breaker | LV434000 |
| IFE Interface (Ethernet Module) | LV434001 |
| IFE Interface + Gateway (Ethernet and ModbuGateway) | LV434002 |
| EIFE embedded Ethernet interface for drawout MasterPacT MTZ | LV851001SP |
| EIFE Spare part kit for one MasterPacT MTZ1 drawout circuit breaker | LV851100SP |
| EIFE Spare part kit for one MasterPacT MTZ2/MTZ3 drawout circuit breaker | LV851200SP |
| IO Module (Input/Output Programmable Module) | LV434063 |
| FDM121 (1 Circuit Breaker to 1 Front Display over ULP) ^[1] | STRV00121 |
| FDM128 (8 Circuit Breakers to 1 Front Display over Ethernet) | LV434128 |

[1] The FDM121 is not compatible with MasterPacT MTZ circuit breakers.

Enerlin'X System Accessories

Accessories for Enerlin'X Modules

Table 7.150: Accessories for Interfacing Enerlin'X Modules with MasterPacT MTZ/NT/NW and PowerPacT H/J/L/P/R Circuit Breakers

| Description | Part Number | |
|--|-----------------------|-------------|
| Circuit Breaker ULP Cord—BCM to Enerlin'X Interface Module | L = 0.35 m (1.15 ft.) | LV434195 |
| | L = 1.3 m (4.27 ft.) | LV434196 |
| | L = 3 m (9.24 ft.) | LV434197 |
| | L = 5 m (16.40 ft.) | LV434198 |
| NSX ULP Cord for V ≤ 480 V for PowerPacT H/J/L | L = 1.3 m (4.27 ft.) | S434201 |
| | L = 3 m (9.24 ft.) | S434202 |
| NSX ULP Cord for V > 480 V for PowerPacT H/J/L | L = 1.3 m (4.27 ft.) | S434204 |
| | L = 3 m (9.24 ft.) | S434203 |
| BSCM (Breaker Status and Control Module) with NSX ULP Cord For PowerPacT H/J/L | L = 1.3 m (4.27 ft.) | S434201BX |
| | L = 3 m (9.24 ft.) | S434202BX |
| Replacement BSCM for Modbus SL or ULP for PowerPacT H/J/L | — | S434220 |
| BSCM with NSX ULP Cord for V > 480 Vac for PowerPacT H/J/L | L = 1.3 m (4.27 ft.) | S434204BX |
| | L = 3 m (9.24 ft.) | S434303BX |
| BSCM with MB SL Cord for V ≤ 480Vac [2] | L = 3.0 m (9.84 ft.) | S434223BX |
| | L = 1.3 m (4.27 ft.) | S434222BX |
| | L = 0.35 m (1.15 ft.) | S434221BX |
| Modbus SL Cord for V ≤ 480Vac [2] | L = 3.0 m (9.84 ft.) | S434223 |
| | L = 1.3 m (4.27 ft.) | S434222 |
| | L = 0.35 m (1.15 ft.) | S434221 |
| Modbus SL Hub for Daisy chain, 3x RJ45 connectors, DIN rail mount, stacking connector compatible [2] | — | S434224 |
| ULP Cable, 10 Cables (Male to Male RJ45) | L = 0.3 m (0.98 ft.) | TRV00803 |
| | L = 0.6 m (1.97 ft.) | TRV00806 |
| ULP Cable, 5 Cables (Male to Male RJ45) | L = 1 m (3.28 ft.) | TRV00810 |
| | L = 2 m (6.56 ft.) | TRV00820 |
| | L = 3 m (9.84 ft.) | TRV00830 |
| ULP Cable, 1 Cable (Male to Male RJ45) | L = 5 m (16.40 ft.) | TRV00850 |
| RJ45 Female/Female Connector, 10 Connectors | — | TRV00870 |
| ULP Line Terminator, 10 Terminators | — | TRV00880 |
| Insulated ULP Module and Circuit Breaker Cord (for system voltage > 480 Vac) (Cord with female socket) | L = 1 m (3.28 ft.) | S434204 |
| | L = 3 m (9.84 ft.) | S434203 |
| Stacking Accessory (10 stacking accessories for IFM) | — | TRV00217 |
| Adaptor Cable (for IFM V2 Modbus daisy chaining) | — | LV434211 |
| Modbus Line Terminator for Screw Terminal, 2 Terminators | — | VW3A8306DRC |
| Modbus Line Terminator for RJ45 Terminal, 2 Terminators | — | VW3A8306RC |
| Surface-Mounting Accessory for FDM121 | — | TRV00128 |
| ULP Port Modules for: | | |
| MasterPacT MTZ1 Fixed Circuit Breaker | — | LV850063SP |
| MasterPacT MTZ2/MTZ3 Fixed Circuit Breaker | — | LV850061SP |
| MasterPacT MTZ1 Drawout Circuit Breaker | — | LV850064SP |
| MasterPacT MTZ2/MTZ3 Drawout Circuit Breaker | — | LV850062 |
| EIFE Cable for Drawout MasterPacT MTZ1 Circuit Breaker | — | LV851120SP |
| EIFE Cable for Drawout MasterPacT MTZ2/MTZ3 Circuit Breaker | — | LV851220SP |

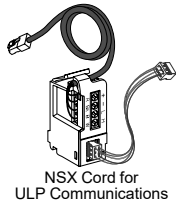

NSX Cord for ULP Communications

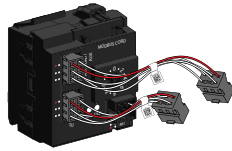

Breaker Status and Control Module (BSCM)

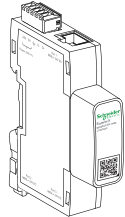

Modbus SL Hub



Modbus SL Cord



AD External Power Supply Module 24 Vdc



ABL8RPS24030



ABL8RPS24100

Recommended 24 Vdc Power Supplies

Available 24 Vdc power supplies include the range of Phaseo ABL8 modules and the AD modules:

- Schneider Electric Phaseo ABL8 power supplies (3 to 10 A, overvoltage category II) are recommended for large installations.
- Schneider Electric AD power supplies (1 A, overvoltage category IV) are recommended in the following cases:
 - For installations limited to a few IMUs.
 - As a power supply of MicroLogic trip units in MasterPacT NT/NW or PowerPacT P- and R-frame circuit breakers.

7 Table 7.151: Power Supply Modules for MicroLogic Trip Units and Enerlin'X Modules

| Power Supply | Rating | Input-Output Voltage | Catalog No. |
|---|--------|----------------------|--------------|
| Schneider Electric AD Power Supply Primary overvoltage category IV Temperature: -25°C tp +70°C (-13°F to +158°F) | 1 A | 24/30 Vac, 24 Vdc | LV454440 |
| | | 48/60 Vac, 24 Vdc | LV454441 |
| | | 100/125 Vac, 24 Vdc | LV454442 |
| | | 110/130 Vac, 24 Vdc | LV454443 |
| | | 200/240 Vac, 24 Vdc | LV454444 |
| Schneider Electric Phaseo ABL8 Power Supply Primary overvoltage category II Temperature: 0°C tp +60°C (32°F to +140°F) (derated to 80% of the current above 50°C [122°F]) | 3 A | 100/500 Vac, 24 Vdc | ABL8RPS24030 |
| | 5 A | 100/500 Vac, 24 Vdc | ABL8RPS24050 |
| | 10 A | 100/500 Vac, 24 Vdc | ABL8RPS24100 |

[2] Modbus serial only ≤ 480Vac. Use only with matching Modbus serial components.

New!

Communication Architecture - Modbus Direct MCCBs

NOTE: Refer the Smart System Data Acquisition user guide (<https://www.schneider-electric.us/en/download/document/0614DB1801/>) to aid in component selection for Smart Systems.

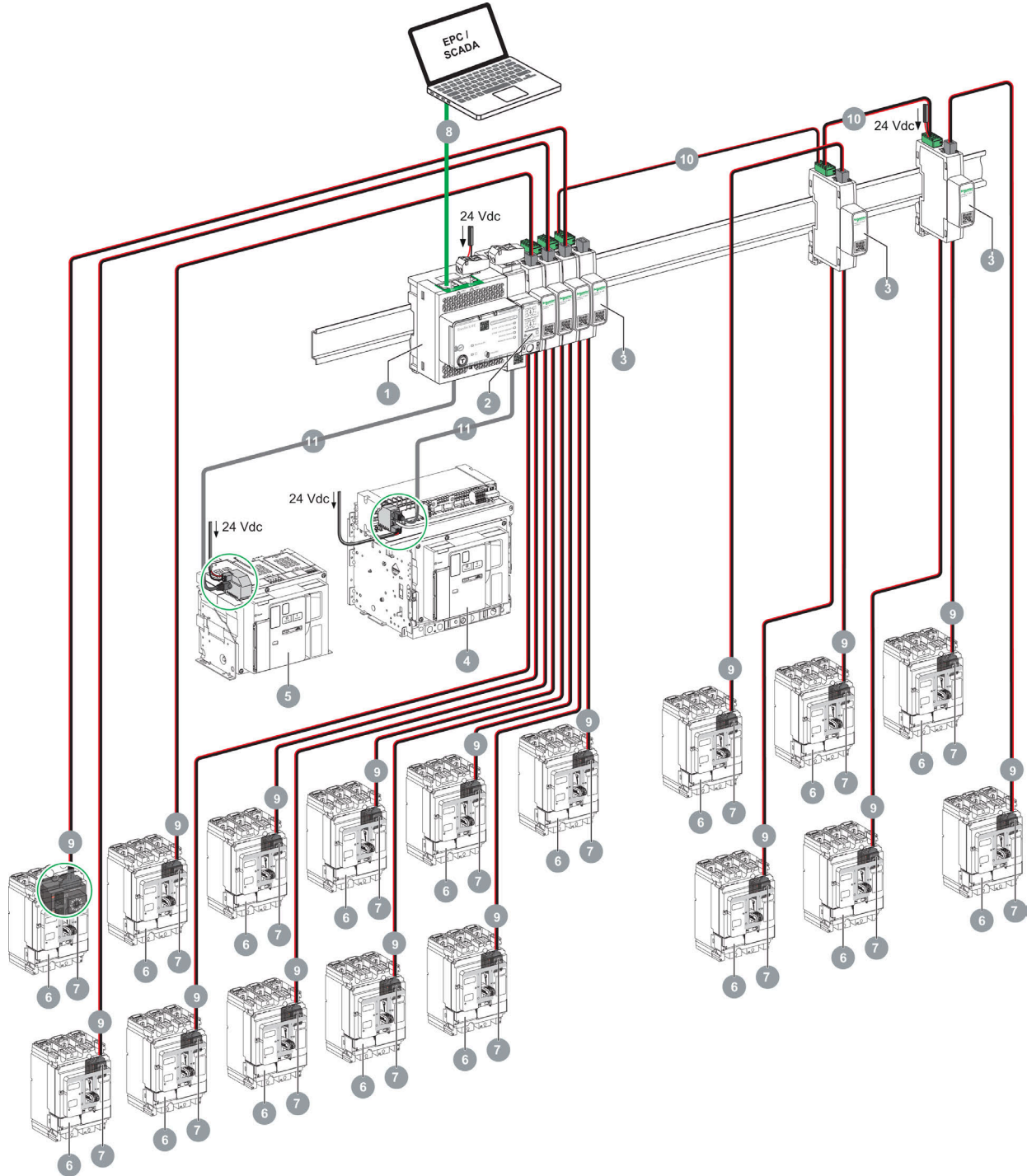
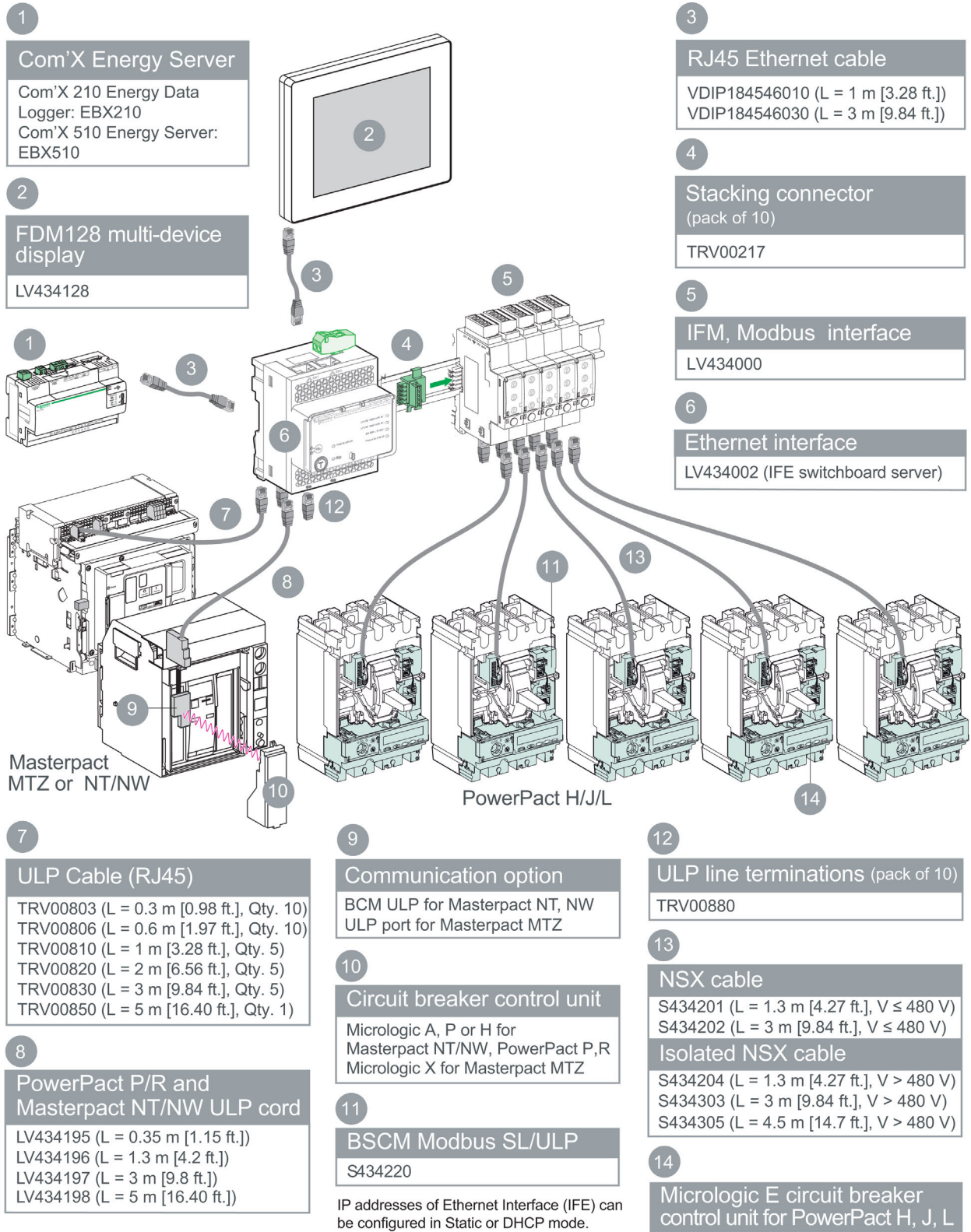

Table 7.152: Legend

| | | | |
|---|---------------------------------------|----|--|
| 1 | IFE (LV434001/LV434002) | 7 | BSCM MBSL/ULP (S434220) |
| 2 | IFM (LV434000) | 8 | Ethernet |
| 3 | Modbus SL hub (S434224) | 9 | BSCM MBSL cord (S434221/S434222/S434223) |
| 4 | Drawout MasterPacT™ MTZ1/MTZ2/MTZ3 | 10 | Modbus cord |
| 5 | Fixed MasterPacT MTZ1/MTZ2/MTZ3 | 11 | ULP cord |
| 6 | ComPacT NSX/PowerPacT H-, J-, L-Frame | | |

Hybrid Communication—Ethernet and Modbus

NOTE: Refer the Smart System Data Acquisition user guide (<https://www.schneider-electric.us/en/download/document/0614DB1801/>) to aid in component selection for Smart Systems.



7 MINIATURE AND MOLDED CASE CIRCUIT BREAKERS

Communications—Direct Ethernet

NOTE: Refer the Smart System Data Acquisition user guide (<https://www.schneider-electric.us/en/download/document/0614DB1801/>) to aid in component selection for Smart Systems.

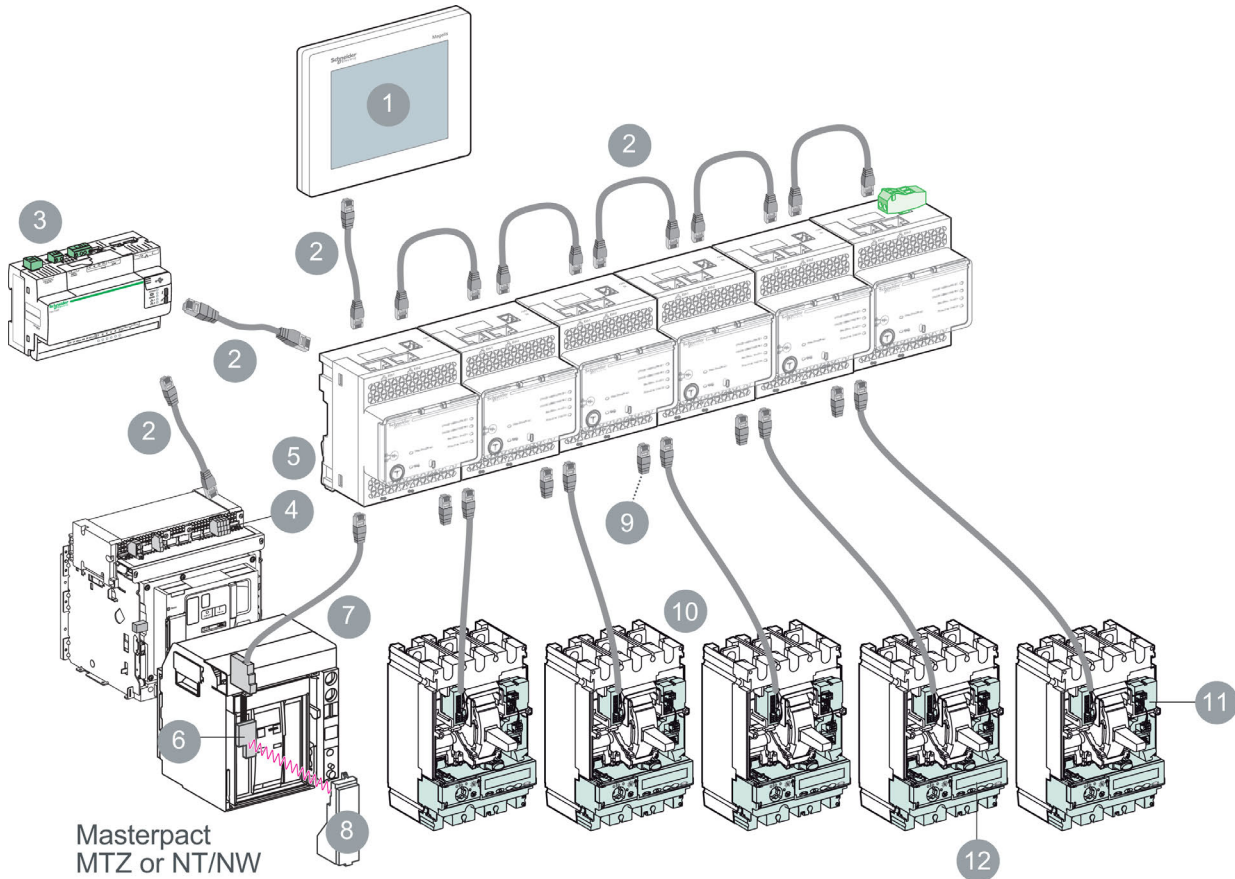

Masterpact
MTZ or NT/NW

1
FDM128 Multi-Device Display
LV434128

2
RJ45 Ethernet Cable
VDIP184546010 (L = 1 m [3.28 ft.])
VDIP184546030 (L = 3 m [9.84 ft.])

3
Com'X Energy Server
Com'X 210 Energy Data Logger: EBX210
Com'X 510 Energy Server: EBX510

4
EIFE Embedded Ethernet Interface
LV851120SP

IP addresses of Ethernet Interface (IFE) can be configured in Static or DHCP mode.

5
IFE Ethernet Interface
LV434001

6
Communication Option
BCM ULP for Masterpact NT, NW
ULP port for Masterpact MTZ

7
PowerPact P/R and Masterpact NT/NW ULP Cord
LV434195 (L = 0.35 m [1.15 ft.])
LV434196 (L = 1.3 m [4.27 ft.])
LV434197 (L = 3 m [9.24 ft.])
LV434198 (L = 5 m [16.40 ft.])

8
Circuit breaker control unit
Micrologic A, P or H for Masterpact NT/NW, PowerPact P,R
Micrologic X for Masterpact MTZ

9
ULP line terminations (pack of 10)
TRV00880

10
NSX cable
S434201 (L = 1.3 m [4.27 ft.], V ≤ 480 V)
S434202 (L = 3 m [9.84 ft.], V ≤ 480 V)
Isolated NSX cable
S434204 (L = 1.3 m [4.27 ft.], V > 480 V)
S434303 (L = 3 m [9.84 ft.], V > 480 V)
S434305 (L = 4.5 m [14.7 ft.], V > 480 V)

11
BSCM Modbus SL/ULP
S434220

12
Micrologic E circuit breaker control unit for PowerPact H, J, L

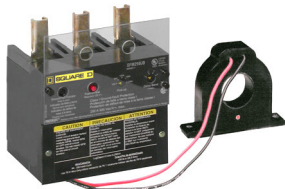

GFM250 with Optional GFM25CT

MicroLogic™ Add-on Ground-Fault Module (GFM)

The MicroLogic Ground-Fault Module (GFM) is a UL Listed/CSA Certified circuit breaker accessory which protects equipment from damage caused by ground faults. It is an add-on module which, when connected to a PowerPacT H- or J-frame thermal-magnetic circuit breaker only, provides ground-fault sensing and ground-fault relay functions.

HD/JD ground-fault modules feature:

- Adjustable ground-fault pickup levels
- Adjustable ground-fault time delays
- Integral ground fault push-to-test feature
- Ground-fault indicator (mechanical for local, contacts for remote)
- All GFMs are supplied for I-Line™ mounting as standard, easily convertible to unit mount by removing the I-Line bracket
- Fault-powered (through the sensing current transformer) for electronics, shunt trip, and integral test feature. Meets NEC 230.95(C)
- A 12 Vdc shunt trip module (Catalog No. P29382) is required in the circuit breaker. This may be field installed or factory installed when the circuit breaker is ordered with an -SN suffix.
- UL 1053 — Ground-fault Sensing and Relaying Equipment

The GFM system requires the following:

- H-frame (15–150 A) or J-frame (150–250 A) molded case circuit breaker
- Shunt trip is required for the function of the GFM (may be factory-installed or field-installed)
- Bus bar connection (terminal nut inserts) for OFF end of circuit breaker
- Optional neutral current transformer, catalog number GFM25CT (must be ordered for 4-wire applications). NOTE: Ground-fault modules cannot be used for alarming only.

Table 7.153: Module/Enclosure Selection Chart [1]

| Companion Circuit Breaker Prefix | Cat. No. [2] | I-Line Switchboard | Ground-fault Pickup Adjustment Range |
|----------------------------------|--------------|--|--------------------------------------|
| HD, HG, HJ, HL | GFM150HD | LA | 20–100 A |
| JD, JG, JJ, JL | GFM250JD | LA | 40–200 A |
| Accessories | | | |
| H & J | GFM25CT | Optional Neutral Current Transformer (required for 4-wire loads) | |

Earth Leakage Module (ELM) for PowerPacT H- and J-Frame MCCBs

The Earth Leakage Module (ELM) is an add-on module which, when connected to a PowerPacT H- or J-frame MCCB, provides low-level ground-fault sensing and ground-fault relay functions.

Because these ELMs are highly sensitive (30 mA to 3 A), they provide much greater protection than GFMs (20 to 200 A sensitivity). The ELMs provide greater protection of control circuits and other sensitive equipment. The associated circuit breaker must have a 48 Vdc shunt trip, which may be field-installed (kit P29392) or factory-installed (suffix –SP) in the H- or J-Frame circuit breaker.

Add-on Earth Leakage Module (ELM) Features:

- Adjustable ground-fault pickup levels as low as 30 mA
- Adjustable ground-fault time delays from instantaneous to 500 msec (Time delay can be applied to the 30 mA setting)
- Integral ground fault push-to-test feature
- Ground-fault indicator; pop-up button for local status and contacts for remote indication (to be used only with the tripping option)
- All ELMs are supplied for I-Line™ mounting and are easily convertible to unit-mount by removing the I-Line brackets
- Three poles; 240 to 600 Vac maximum: 3-wire applications only (no neutral)
- Line-power obtained through internal bus to provide power for electronics, shunt trip, and integral test feature.
- A shunt trip is required in the circuit breaker; it may be field-installed or factory-installed in the PowerPacT H and J circuit breakers.
- UL 1053 – Ground-fault Sensing and Relaying Equipment

Table 7.154: ELM Selection Chart [3]

| Companion Circuit Breaker [4] | Enclosure Space Required I-Line Switchboard | Pick-Up Adjustment Range | Catalog Number |
|-------------------------------|---|--------------------------|----------------|
| | | | |
| HD, HG, HJ, HL | LA | 30 mA–3 A | ELM150HD |
| JD, JG, JJ, JL | LA | 30 mA–3 A | ELM250JD |



J-Frame Unit Mount with ELM Installed

[1] At 250 A, the GFM250JD can be used with 80% rated circuit breakers only.

[2] See Supplemental Digest Section 3 for additional GFMs.

[3] At 250 A, the ELM250JD can be used with 80% rated circuit breakers only.

[4] For Factory Installation of ELM Module: For termination designation (3rd letter of catalog number) use ONLY "M". Add factory installed 48 Vdc shunt trip (suffix SP) to breaker plus suffix VL or VM.

Miniature and Molded Case Circuit Breaker Dimensions

Table 7.155: QO™, QOU, Multi9™ Circuit Breakers

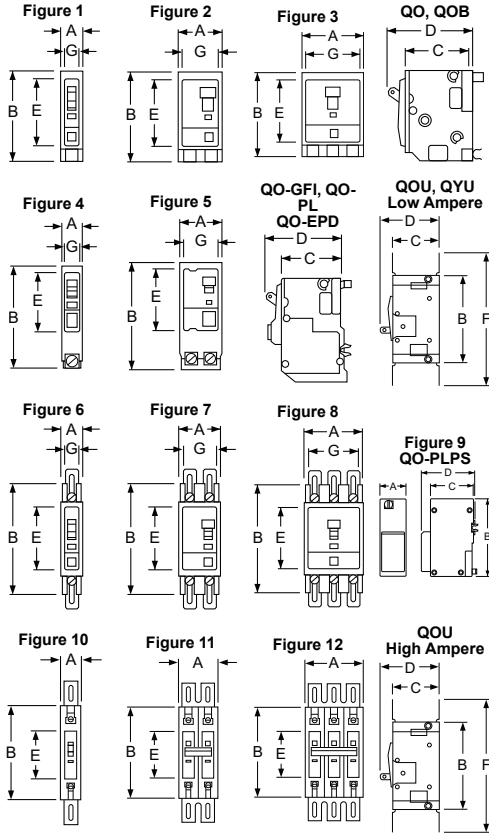

| Circuit Breaker Cat. No. Prefix | Poles | Fig. No. | Dimensions—Inches | | | | | | |
|------------------------------------|-------|-------------|-------------------|----------|------|------|------|----------|------|
| | | | A | B | C | D | E | F | G |
| QO, QOB | 1 | 1 | 0.75 | 3.00 [1] | 2.31 | 2.91 | 2.25 | — | 0.59 |
| | 2 | 2 | 1.50 | 3.00 [1] | 2.31 | 2.91 | 2.25 | — | 1.34 |
| | 3 | 3 | 2.25 | 3.00 [1] | 2.31 | 2.91 | 2.25 | — | 2.09 |
| QOB-VH 150 A QOB-VH 110–150 A | 2 | 2 | 3.0 | 5.72 | 2.53 | 4.90 | 3.78 | — | 2.85 |
| | 3 | 3 | 4.50 | 5.72 | 2.53 | 4.90 | 3.78 | — | 4.35 |
| QO-PL QO-GFI QO-EPD | 1 | 4 | 0.75 | 4.12 [2] | 2.31 | 2.91 | 2.25 | — | 0.59 |
| | 2 | 5 | 1.50 | 4.12 [2] | 2.31 | 2.91 | 2.25 | — | 1.34 |
| | 3 | 5 | 2.25 | 4.12 [2] | 2.31 | 2.91 | 2.25 | — | 2.09 |
| QOU QYU Low Ampere | 1 | 6 | 0.75 | 4.05 [3] | 2.38 | 2.98 | 2.25 | 5.00 [4] | 0.62 |
| | 2 | 7 | 1.50 | 4.05 [3] | 2.38 | 2.98 | 2.25 | 5.00 [4] | 1.37 |
| | 3 | 8 | 2.25 | 4.05 [3] | 2.38 | 2.98 | 2.25 | 5.00 [5] | 2.12 |
| QOU High Ampere | 1 | 10 | 0.75 | 4.45 | 2.37 | 2.96 | 2.25 | 6.78 | — |
| | 2 | 11 | 1.50 | 4.45 | 2.37 | 2.96 | 2.25 | 6.78 | — |
| | 3 | 12 | 2.25 | 4.45 | 2.37 | 2.96 | 2.25 | 6.78 | — |
| Multi9™ C60 | 1 | 13 | 0.71 | 3.19 | 1.73 | 2.76 | 1.77 | — | — |
| | 2 | 14 | 1.42 | 3.19 | 1.73 | 2.76 | 1.77 | — | — |
| | 3 | 15 | 2.13 | 3.19 | 1.73 | 2.76 | 1.77 | — | — |
| | 4 | 16 | 2.84 | 3.19 | 1.73 | 2.76 | 1.77 | — | — |
| QO-PLPS Power Supply | 2 | 9 | 1.45 | 4.35 | 2.42 | 3.11 | — | — | — |

Table 7.156: QB, QD, QG, QJ, Q4, FA, LA, Circuit Breakers

| Circuit Breaker Cat. No. Prefix | Poles | Fig. No. | Dimensions—Inches | | | | | | | |
|------------------------------------|-------|-------------|-------------------|------|------|------|------|------|------|------|
| | | | A | B | C | D | E | F | G | H |
| QB, QD, QG, QJ | 2 | 22 | 6.47 | 3.00 | 3.02 | 3.93 | [6] | 4.25 | — | — |
| | 3 | 23 | 6.47 | 4.50 | 3.02 | 3.93 | [6] | 4.25 | 1.50 | 0.75 |
| FAL, FHL | 1 | 21 | 6.00 | 1.50 | 3.16 | 4.13 | 0.44 | 5.13 | 1.50 | — |
| | 2 | 22 | 6.00 | 3.00 | 3.16 | 4.13 | 0.44 | 5.13 | — | — |
| | 3 | 23 | 6.00 | 4.50 | 3.16 | 4.13 | 0.44 | 5.13 | 1.50 | 0.75 |
| Q4L, LAL, LHL | 2 & 3 | 23 | 11.00 | 6.00 | 4.06 | 5.84 | 0.88 | 9.25 | 2.00 | 1.00 |

Table 7.157: Shipping Weights [7]

| Frame Size | Approx. Shipping Weight (Lbs.) | Frame Size | Approx. Shipping Weight (Lbs.) |
|-------------|--------------------------------|----------------|--------------------------------|
| FAL, FHL 1P | 2 | QB, QD, QG, QJ | 4 |
| FAL, FHL 2P | 3 | LAL, LHL | 15 |
| FAL, FHL 3P | 5 | Q4L | 15 |

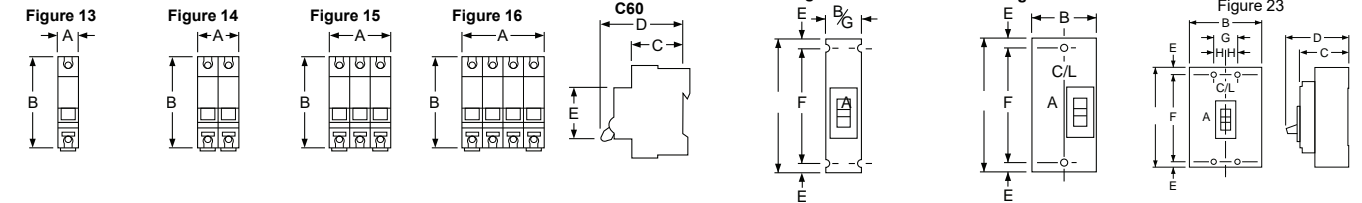

[1] 35–70 A is 3.12 in; 80–100 A 2P and 70–100 A 3P are 3.50 in.
 [2] QO-PL is 4.55 in.
 [3] 80–100 A 1P and 80–125 A 2P are 4.45 in.
 [4] 80–100 A 1P and 80–125 A 2P are 6.78 in.
 [5] 70–100 A is 6.78 in.
 [6] Dimensions E are 1.59 in at ON end and 0.63 in at OFF end.
 [7] All weights are for 3P circuit breakers unless otherwise noted.

Molded Case Circuit Breaker Dimensions

Table 7.158: PowerPacT B-, H-, J-, and L-Frame Circuit Breakers

| Circuit Breaker Frame | No. of Poles | Fig. No. | Dimensions — Inches | | | | | | | |
|-----------------------|--------------|----------|---------------------|------|------|------|------|------|------|------|
| | | | A | B | C | D | E | F | G | H |
| B-Frame | 1 | 35 | 6.79 | 1.06 | 3.15 | 4.01 | 0.20 | 6.33 | — | 5.39 |
| | 2 | 36 | 6.22 | 2.12 | 3.15 | 4.01 | 0.86 | 4.48 | — | 5.39 |
| | 3 | 37 | 6.22 | 3.19 | 3.15 | 4.01 | 0.86 | 4.48 | 1.06 | 5.39 |
| | 4 | 38 | 6.22 | 4.25 | 3.15 | 4.01 | 0.86 | 4.48 | 2.12 | 5.39 |
| H-Frame | 2 [8] | 25 | 6.40 | 2.74 | 2.87 | 4.36 | 0.74 | 4.92 | — | — |
| | 3 | 26 | 6.40 | 4.12 | 2.87 | 4.36 | 0.74 | 4.92 | 1.38 | — |
| J-Frame | 3 | 27 | 7.52 | 4.12 | 2.87 | 5.00 | 1.30 | 4.92 | 1.38 | — |
| L-Frame | 3 | 28 | 13.38 | 5.51 | 3.75 | 6.61 | 2.22 | 7.87 | 1.77 | — |

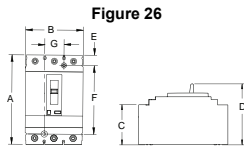
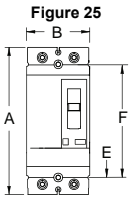

Figure 27

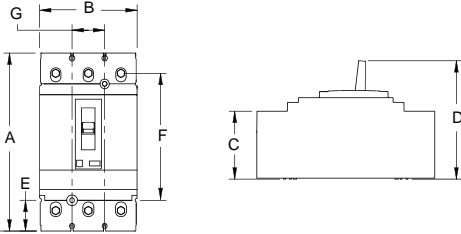

Figure 28

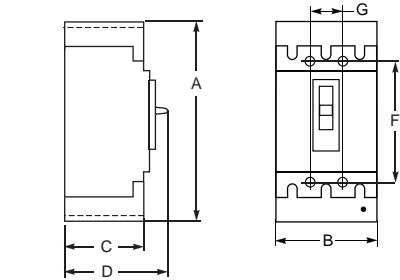

Figure 29

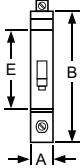

Figure 30



Figure 31

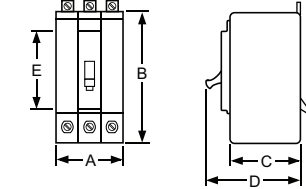

Figure 32

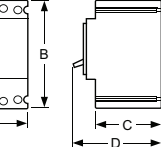

Figure 33

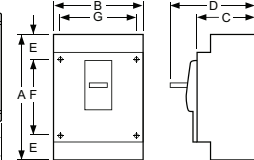

Figure 34

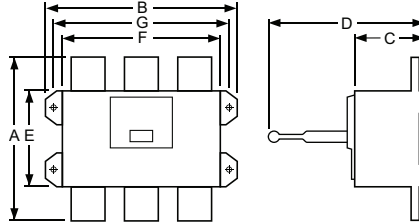

Figure 35

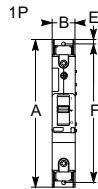

Figure 37

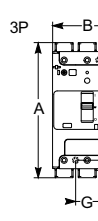

Figure 36

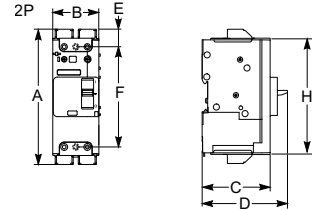

Figure 38

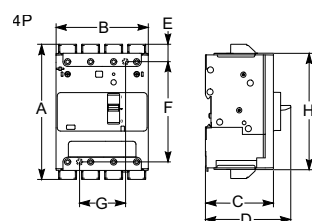

Table 7.159: ED, EG, EJ, and GJ Circuit Breakers

| Circuit Breaker Cat. No. Prefix | No. of Poles | Fig. No. | Dimensions — Inches | | | | |
|---------------------------------|--------------|----------|---------------------|------|------|------|------|
| | | | A | B | C | D | E |
| ED, EG, EJ | 1 | 29 | 0.98 | 5.66 | 3.09 | 4.05 | 3.32 |
| ED, EG, EJ | 2 | 30 | 1.96 | 5.66 | 3.09 | 4.05 | 3.32 |
| ED, EG, EJ | 3 | 31 | 2.94 | 5.66 | 3.09 | 4.05 | 3.32 |
| GJ | 3 | 32 | 3.54 | 4.72 | 2.76 | 3.94 | 2.20 |

Table 7.160: PowerPacT M-, P-, and R-Frame Circuit Breakers

| Circuit Breaker Frame | No. of Poles | Fig. No. | Dimensions — Inches | | | | | | |
|---------------------------|--------------|----------|---------------------|-------|------|-------|------|-------|-------|
| | | | A | B | C | D | E | F | G |
| M-Frame (800 A and below) | 2, 3 | 33 | 12.86 | 8.27 | 5.77 | 8.05 | 2.49 | 7.87 | 7.83 |
| P-Frame (1000–1200 A) | 2, 3 | 33 | 16.16 | 8.27 | 5.77 | 8.05 | 4.19 | 7.87 | 7.83 |
| R-Frame | 2, 3 | 34 | 16.24 | 16.54 | 6.63 | 14.49 | 8.73 | 14.25 | 15.35 |

Table 7.161: Shipping Weights [9]

| Frame Size | Approx. Shipping Weight (Lbs.) | Frame Size | Approx. Shipping Weight (Lbs.) |
|------------|--------------------------------|------------------------|--------------------------------|
| B-Frame 1P | 1 | H-Frame 2P | 4 |
| B-Frame 2P | 2 | H-Frame 3P | 5 |
| B-Frame 3P | 3 | J-Frame | 5 |
| B-Frame 4P | 4 | L-Frame | 14 |
| EDB 1P | 2 | M-Frame | 29 |
| EDB 2P | 3 | P-Frame | 32 |
| EDB 3P | 4 | R-Frame (Without RLTB) | 52 |

[8] Only HD and HG are in 2P module, HJ, HL and HR 2P are in 3P module.

[9] All weights are for 3P circuit breakers unless otherwise noted.

PowerPacT Circuit Breaker Enclosures

- The enclosures for the family of PowerPacT circuit breakers B- through Q-frame are cULus listed unless otherwise noted.
- The enclosures are suitable for service entrance equipment when neutral assembly is installed.
- The short circuit current rating of the enclosed circuit breakers is equal to the rating of the circuit breaker installed unless otherwise noted.
- All enclosures will accept 100% rated circuit breakers unless otherwise noted.

PowerPacT B-Frame Circuit Breaker Enclosures

- The enclosures' maximum short circuit ratings are 65 kA at 600Y, 65 kA at 480 Vac, 100 kA at 240 Vac and 50 kA at 250 Vdc unless otherwise noted.
- Enclosures accept 100% rated circuit breakers [8].

Table 7.162: PowerPacT B-Frame Circuit Breaker Enclosures

| Circuit Breaker | | | Enclosure Catalog Number | | | Accessory Catalog Number | |
|-----------------|-----------|-------|--|------------------------|---------------------------|--------------------------|--------------------|
| Cat. No. Prefix | Rating | Poles | | | | Neutral Assembly Kit | Service Ground Kit |
| | | | NEMA 1 Flush | NEMA 1 Surface | NEMA 3R | | |
| BDL, BGL, BJL | 15–100 A | 2, 3 | B125F | B125S | B125RB | SN100FA | PKOGTA2 |
| BDL, BGL, BJL | 110–125 A | 2, 3 | | | | SN225KA | |
| BKL | 15–30 A | 2 | | | | SN100FA | |
| | | | NEMA 4, 4X, 5 Type 304 Stainless Steel | NEMA 12 With Knockouts | NEMA 12 Without Knockouts | | |
| BDL, BGL, BJL | 15–100 A | 2, 3 | B125DS | B125A | B125AWK[1] | SN100FA | PKOGTA2 |
| BDL, BGL, BJL | 110–125 A | 2, 3 | | | | SN225KA | |
| BKL | 15–30 A | 2 | | | | SN100FA | |

PowerPacT™ H- and J-Frame Circuit Breaker Enclosures

The enclosures' maximum short circuit ratings are 25 kAIR at 600 Vac, 65 kAIR at 480 Vac, 125 kAIR at 240 Vac and 20 kA at 250 Vdc unless otherwise noted. Enclosures accept 100% rated circuit breakers [2]. The enclosures are not compatible with earth-leakage or ground-fault modules.

H- and J-frame circuit breakers with MicroLogic trip units can be used with these enclosures, but have the following limitations:

- No communication accessories can be mounted in the enclosure (no IFM or Front Display Module, IFE, etc).
- The trip unit will not be accessible or visible without the removal of the cover (except J250F and J250S).
- For LSIG, there is no room for the NCT to mount in the enclosure.

Table 7.163: PowerPacT H- and J-Frame Circuit Breaker Enclosures

| Circuit Breaker | | | Enclosure Cat. No. | | | Neutral Assembly Kit Cat. No. | Service Ground Kit Cat. No. |
|--------------------|-----------|-------|--|--|-----------------------------------|-------------------------------|-----------------------------|
| Cat. No. Prefix | Rating | Poles | | | | | |
| | | | NEMA 1 Flush | NEMA 1 Surface | NEMA 3R | | |
| HDL | 15–100 A | 3 | — | HD100S [3][4][5] | — | SN100FA | PKOGTA2 |
| HDL, JDL | 125–225 A | 3 | — | JD250S [6][4][5] | — | SN225KA | PKOGTA2 |
| | 125–250 | | | | | SN400LA | |
| HDL, HGL | 15–100 A | 2 | H150F | H150S | H150R [7] | SN100FA | PKOGTH150 |
| HJL, HLL | 125–150 A | 2 | | | | SN400LA | |
| HDL, HGL, HJL, HLL | 15–100 A | 3 | J250F | J250S [8] | J250R [7][9] | SN100FA | PKOGTH150 |
| | 125–150 A | 3 | | | | SN400LA[10] | |
| JDL, JGL, JLL, JLL | 150–250 A | 2, 3 | | | | | |
| | | | NEMA 4, 4X, 5 [11] Type 304 Stainless Steel [12] | NEMA 4, 4x, 5 [11] Type 316 Stainless Steel [12] | NEMA 12/3R Without Knockouts [12] | | |
| HDL, HGL, HJL, HLL | 15–100 A | 2, 3 | J250DS [13] | J250SS [13] | J250AWK [13] | SN100FA | PKOGTH150 |
| | 125–150 A | 2, 3 | | | | SN400LA[10] | |
| JDL, JGL, JLL, JLL | 150–250 A | 2, 3 | | | | | |

[1] For NEMA 3R applications, remove drain scerw from bottom end well.
 [2] Use only 90°C (minimum) rated wire sized per ampacity of 75°C rated conductors for 100% rated circuit breakers.
 [3] Rated for 240 Vac maximum. Short circuit current rating is 25 kAIR at 240 Vac.
 [4] Accepts standard 80% rated circuit breakers only. Not rated for 100% rated circuit breakers.
 [5] Use copper conductors only.
 [6] Rated 480 Vac maximum. Short circuit current rating is 18 kAIR at 480 V.
 [7] For conduit entry through the top end wall use one of the following Square D conduit hubs: A200L for 2.00 in., A250L for 2.50 in., A300L for 3.00 in., A350L for 3.50 in. or A400L for 4.00 in.
 [8] Add suffix BE if no knockouts are required on the end walls.
 [9] For access to the circuit breaker's standard, ammeter or energy trip unit panel/LCD, add suffix T.
 [10] For 200% neutral use copper wire only.
 [11] Complete rating is NEMA 3, 3R, 4, 4X, 5, and 12.
 [12] For NEMA 3R applications, remove drain screw from bottom endwall.
 [13] Add suffix VW for visibility to the standard, ammeter or energy trip unit of the PowerPacT circuit breaker.

PowerPacT L-Frame Circuit Breaker and Molded Case Switch Enclosures

All enclosures accept 80% rated circuit breakers. The enclosures will also accept 100% rated circuit breakers to 400 amps. The enclosures have a blank top end wall and require field-cut openings. For details and hub catalog numbers see page 3–10.

Table 7.164: PowerPacT L-Frame Circuit Breaker Enclosures

| Circuit Breaker | | | Cat. No. | | | |
|--------------------------|-----------|-------|---|----------------------|----------------------------------|--------------------|
| Cat. No. Prefix | Rating | Poles | NEMA 12/3R Enclosures Without Knockouts | Neutral Assembly Kit | Copper Only Neutral Assembly Kit | Service Ground Kit |
| LDL, LGL, L JL, LLL, LRL | 250–400 A | 3 | L600AWK [14][15][16] | SN400LA | SNC400LX | PKOGTA4 |
| | 400–600 A | | | SN1000MA | SNC800LX | |
| LGL, LLL, LRL | 250–400 A | 3 | L600AWKMC [17][15] | SN400LA | SNC400LX | PKOGTA4 |
| | 400–600 A | | | SN1000MA | SNC800LX | |

PowerPacT Q-Frame Circuit Breaker Enclosures

The enclosures for the PowerPacT Q Frame Circuit Breaker are UL listed. The short circuit ratings of these enclosed circuit breakers are equal to the interrupter ratings, at the supply voltage marked on the circuit breaker installed, unless otherwise noted.

Table 7.165: PowerPacT Q-Frame Circuit Breaker Enclosures

| Circuit Breaker | | | Enclosure Cat. No. | | | Neutral Assembly Kit Cat. No. | Service Ground Kit Cat. No. |
|-------------------------|----------|-------|--------------------|----------------|----------------|-------------------------------|-----------------------------|
| Cat. No. Prefix | Rating | Poles | NEMA 1 Flush | NEMA 1 Surface | NEMA 3R | | |
| QBL, QDL, QGL, QJL [18] | 70–225 A | 2 | — | Q22200NS [19] | Q22200NRB [19] | — | PKOGTA2 |
| | | 2, 3 | Q23225NF | Q23225NS | Q23225NRB | | |

PowerPacT M- and P-Frame Circuit Breaker Enclosures

All enclosures will accept 80% rated circuit breakers. The P1200 enclosures will accept 100% rated circuit breakers to 800 A. If a CT neutral is required, the enclosure will no longer accept a 200% neutral. The M800R and the P1200R enclosures have a blank top end wall and require field-cut openings. For details and hub catalog numbers see page 3–10.

Table 7.166: PowerPacT M- and P-Frame Circuit Breaker Enclosures

| Circuit Breaker | | | Cat. No. | | | | | | |
|------------------------------|------------|-------|--|--|-----------------------------------|----------------------|----------------------------|-------------------------|--------------------|
| Cat. No. Prefix | Rating | Poles | Enclosure | | | Neutral Assembly Kit | 200% Neutral Kit | CT Neutral Kit [20][21] | Service Ground Kit |
| | | | NEMA 1 Flush | NEMA 1 Surface | NEMA 3R | | | | |
| MGL, MJL, PGL, PJL, PKL, PLL | 300–800 A | 2, 3 | — | M800S | M800R | AL800SN | SN800SNI and 2 each SN1200 | S33576MK | PKOGTA4 |
| | | | — | P1200S | P1200R | SN1200 | — | S33576MK | PKOGTA4 |
| | | | NEMA 4, 4X, 5 [22] Type 304 Stainless Steel [15] | NEMA 4, 4X, 5 [22] Type 316 Stainless Steel [15] | NEMA 12/3R Without Knockouts [15] | | | | |
| MGL, MJL, PGL, PJL, PKL, PLL | 300–800 A | 2, 3 | M800DS | M800SS | M800AWK | AL800SN | — | S33576MK | PKOGTA4 |
| PGL, PJL, PKL, PLL | 250–1200 A | 2, 3 | — | — | P1200AWK | SN1200 | — | S33576MK | PKOGTA4 |

PowerPacT L-Frame 500 Vdc Circuit Breaker Enclosures

The PowerPacT L-frame circuit breaker enclosure's maximum short circuit rating is 20 kAIR at 250 Vdc and 50 kAIR at 500 Vdc.

Listed for use ONLY on UPS systems.

Table 7.167: DC Circuit Breaker Enclosures for LG and LL DC-Rated Circuit Breakers

| Circuit Breaker [23] | | | Cat. No. | | |
|----------------------|---------------|-------|--------------------------|-------------------------|--------------------|
| Cat. No. Prefix | Ampere Rating | Poles | NEMA 1 Surface Enclosure | Replacement Ground Lugs | Service Ground Kit |
| LGL, LLL | 300–600 A | 3 | L1200S | 8010440301 | Standard |
| | 700–1200 A | 4 | L1200S | | |

[14] Will accept PowerPacT L-frame circuit breakers and Motor Protectors with suffixes M38X

[15] For NEMA 3R applications, remove drain screw from bottom endwall.

[16] Add suffix VW for visibility to the standard, ammeter or energy trip unit of the PowerPacT circuit breaker.

[17] Will accept PowerPacT L-frame Molded Case Switches.

[18] When the QJL circuit breaker is installed in the enclosure, the enclosure is limited to Short Circuit Current ratings of 65 kAIR at 240 V and 100 kAIR at 208 V.

[19] Limited to 200 A.

[20] Order current transformer kit S33576 separately.

[21] Current transformers applicable only on PowerPacT P circuit breakers. Current limitations are 400–800 A and 400–1200 A respectively for the M800 and P1200 family of enclosures.

[22] Complete rating is NEMA 3, 3R, 4, 4X, 5, and 12.

[23] Use 500 Vdc or 250 Vdc rated circuit breakers only.

LA/LH Circuit Breaker Enclosures
LA/LH Thermal-Magnetic Circuit Breaker Enclosures



The enclosures for the LA/LH thermal-magnetic circuit breakers are UL listed and CSA certified. The enclosures are suitable for service entrance equipment when neutral assembly is installed. The short circuit ratings of these enclosed circuit breakers are equal to the interrupter rating, at the supply voltage marked on the circuit breaker installed.

The LA400R enclosure has a blank top end wall and requires field cut openings. For details and hub catalog numbers see Digest Section 3.

Table 7.168: LA/LH Thermal-Magnetic Circuit Breaker Enclosures

| Circuit Breaker | | | Enclosure | | | Neutral Assembly Kit | Service Ground Kit |
|-----------------|-----------|-------|--|------------------------------|-----------------------------------|----------------------|--------------------|
| Cat. No. Prefix | Rating | Poles | Cat. No. | Cat. No. | Cat. No. | Cat. No. | Cat. No. |
| | | | NEMA 1 Flush | NEMA 1 Surface | NEMA 3R | | |
| LAL, LHL | 125–225 A | 2, 3 | LA400F [24] | LA400S [24] | LA400R | SN225KA | PKOGTA2 |
| | 225–400 A | | | | | 400SN | |
| LAL | 125–400 | 3 | — | LA400LS [25] [26][27][28] | — | SN400LA | |
| | | | NEMA 4, 4X, 5 [29] Type 304 Stainless Steel [30] | NEMA 12K With Knockouts | NEMA 12/3R Without Knockouts [30] | | |
| LAL, LHL | 125–225 A | 2, 3 | LA400DS [27] | — | LA400AWK [27] | SN225KA | PKOGTA2 |
| | 225–400 A | | | | | SN400LA | |

Enclosures for Special Applications

Hazardous Locations: NEMA 7 And NEMA 9 Circuit Breaker Enclosures

The NEMA 7 and 9 enclosures are cULus listed unless otherwise noted. They are rated for use in hazardous locations as defined in NEC Article 500. The short circuit current rating of the enclosed circuit breakers is equal to the rating of the circuit breaker installed unless otherwise noted. They are suitable for use as service entrance equipment when neutral is installed. Enclosures require the use of 75°C copper wire only. The NEMA 7 enclosures are suitable for rainproof applications when the included PKDB1 breather and drain kit is installed.

Table 7.169: NEMA 7 and NEMA 9 Circuit Breaker Enclosures; Thermal-Magnetic B-Frame and PowerPacT J-Frame Circuit Breakers

| Circuit Breaker | | | Enclosure Catalog Number | | Neutral Assembly Kit Cat. No. | Service Ground Kit Cat. No. | Threaded Conduit Provisions, Inches |
|-----------------|-----------|-------|---------------------------------|---------------------------|-------------------------------|-----------------------------|-------------------------------------|
| Cat. No. Prefix | Rating | Poles | NEMA 7/9 Cast Aluminum [31][32] | NEMA 9 Cast Aluminum [32] | | | |
| BKL | 15–30 A | 2 | B100X | — | 100SNA | Included | 1 1/4 in. |
| BDL, BGL, B JL | 15–100 A | 2, 3 | | | | | |
| JDL, JGL | 150–225 A | 2, 3 | J225X [33][34] | J225Y [33][34] | 225SNA | Included | 2 1/2 in. |

Enclosed Molded Case Switches

For information on enclosed molded case switches, see Supplemental Digest Section 3.

[24] Enclosures are provided with the Handle Padlock Attachment (HPALM) for field installation to lock the circuit breaker in the "ON" or "OFF" positions.
 [25] Use copper conductors only.
 [26] Maximum short circuit and voltage is 30 kAIR at 480 Vac.
 [27] LAL or LHL circuit breakers with an MB or MT suffix are not compatible with these enclosures: LA400DS, LA400AWK, and LA400LS.
 [28] Enclosure cover has an integral padlock provision to provide a means to lock the circuit breaker in the "ON" or "OFF" position.
 [29] Complete rating is NEMA 3, 3R, 4, 4X, 5, and 12.
 [30] For NEMA 3R applications, remove drain screw from bottom endwall.
 [31] NEMA 7 — Indoor Hazardous Locations — Division 1 and 2, Class I, Groups C and D; Class II, Groups E, F and G; Class III
 [32] NEMA 9 — Indoor Hazardous Locations — Division 1 and 2, Class ii, Groups E, F and G; Class iii
 [33] Short circuit current rating: 65 kAIR at 240 Vac, 25 kAIR at 480 Vac, and 18 kAIR at 600 Vac
 [34] Not cULus listed due to wire bending space.

Enclosure Accessories

Table 7.170: Neutral Kit Terminal Data

| Neutral Kit Catalog Number | Terminal Lug Data -Total Available (Line plus Load) AWG/kcmil AL/CU | All Copper Neutral Terminal Lug Data -Total Available (Line plus Load) AWG/kcmil |
|----------------------------|---|--|
| 100SNA | (2) 14-1/0 Cu or (2) 12-1/0 Al plus (1) 14-4 Cu | — |
| SN100FA | (4) 14-1/0 Cu or (4) 12-1/0 Al | — |
| SN225KA | (2) 4-300 Al/Cu plus (2) 14-1/0 Al/Cu | — |
| 225SNA | (4) 6-350 Al/Cu | — |
| 400SN | (2) 1-600 or (4) 1-250 Al/Cu, plus (2) 4-300 Al/Cu | — |
| SN400LA | (2) 1-600 or (4) 1-250 Al/Cu, plus (2) 4-300 Al/Cu | — |
| SN1000MA | (6) 3/0-500 Al/Cu, plus (1) 1-4/0 Al/Cu | — |
| SNC400LX | — | (2) 2-600 Cu, plus (2) 6-250 Cu |
| SNC800LX | — | (4) 2-600 Cu, plus (1) 2-4/0 Cu |
| AL800SN | (6) 3/0-500 Al/Cu, plus (2) 6-250 Al/Cu | — |
| SN1200 | (8) 3/0-750 Al/Cu, plus (2) 6-350 Al/Cu | — |
| S33576MK | (8) 3/0-500 Al/Cu, plus (2) 4-300 Al/Cu | — |

Table 7.171: Service Ground Kit Terminal Data

| Service Ground Kit Catalog Number | Terminal Data AWG/kcmil | Lugs Per Kit |
|-----------------------------------|-------------------------|--------------|
| PKOGTA2 | 10-2/0 Cu or 6-2/0 Al | 2 |
| PKOGTH150 | 14-2 Al/Cu | 2 |
| PKOGTJ250 | 6-300 Al/Cu | 2 |
| PKOGTA4 | 6-250 Al/Cu | 4 |

Terminal Shields for Service Entrance Applications

- Can be applied as line side barriers in service entrance applications
- Will fit on top or bottom of the circuit breaker

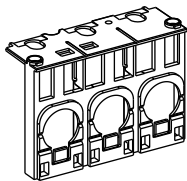

J-Frame Short Lug Shield

Table 7.172: Terminal Shields

| Frame | 2P | 3P |
|------------------------------------|------|--------|
| PowerPacT Q | QSB2 | QSB3 |
| PowerPacT H (3 AWG Max. Wire Size) | — | S37446 |
| PowerPacT H (3/0 Max. Wire Size) | — | S37447 |
| PowerPacT J | — | S37448 |
| PowerPacT M | — | MGJTC |
| PowerPacT P | — | PA12TC |
| LA/LH | — | LAHTC |

See Supplemental Digest Section 3 for special options for enclosures:

- Stainless steel fronts
- Pilot lights, push buttons
- Lock-on SPL0
- Key interlock systems
- Legend plates

Enclosure Dimensions

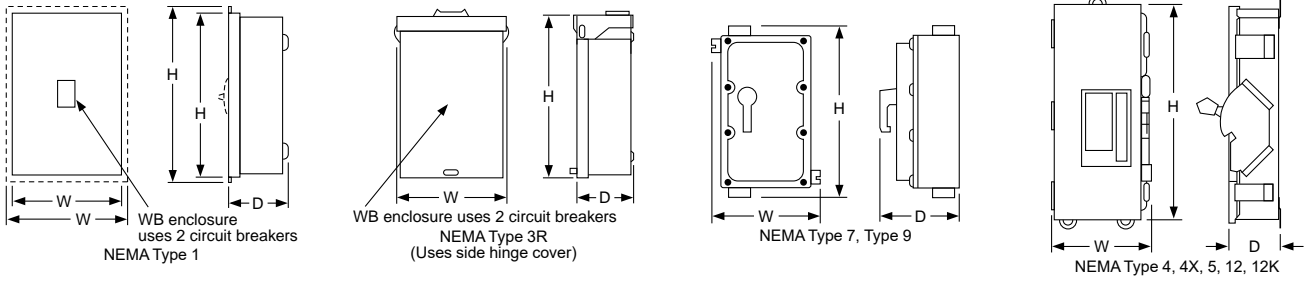

Table 7.173: Dimensions

| Cat. No. | Series | Approximate Dimension | | | | | |
|-----------|--------|-----------------------|---------|--------|--------|-------|--------|
| | | H | | W | | D | |
| | | in. | mm | in. | mm | in. | mm |
| B125F | A01 | 19.5 | 495 | 9.88 | 251 | 4.13 | 105 |
| B125S | A01 | 18.13 | 461 | 8.63 | 219 | 4.13 | 105 |
| B125FSS | A01 | 19.5 | 495 | 9.88 | 251 | 4.13 | 105 |
| B125RB | A01 | 18.0 | 457 | 8.88 | 226 | 4.88 | 124 |
| B125DS | A01 | 19.5 | 495 | 9.13 | 232 | 4.88 | 124 |
| B125SS | A01 | 19.5 | 495 | 9.13 | 232 | 4.88 | 124 |
| B125A | A01 | 19.5 | 495 | 9.13 | 232 | 4.88 | 124 |
| B125AWK | A01 | 19.5 | 495 | 9.13 | 232 | 4.88 | 124 |
| B125AWKMC | A01 | 19.5 | 495 | 9.13 | 232 | 4.88 | 124 |
| HD100S | A01 | 17.00 | 431.8 | 7.90 | 200.7 | 4.75 | 120.7 |
| H150F | A01 | 32.40 | 823 | 15.40 | 391 | 6.00 | 152 |
| H150R | A01 | 31.05 | 789 | 14.47 | 368 | 6.28 | 160 |
| H150S | A01 | 31.36 | 797 | 14.36 | 365 | 6.00 | 152 |
| J250F | A01 | 32.40 | 823 | 15.40 | 391 | 6.00 | 152 |
| J250R | A01 | 31.05 | 789 | 14.47 | 368 | 6.28 | 160 |
| J250S | A01 | 31.36 | 797 | 14.36 | 365 | 6.00 | 152 |
| J250DS | A01 | 32.26 | 819 | 9.72 | 247 | 7.94 | 202 |
| J250SS | A01 | 32.26 | 819 | 9.72 | 247 | 7.94 | 202 |
| J250AWK | A01 | 32.26 | 819 | 9.72 | 247 | 7.94 | 202 |
| JD250S | A01 | 26.40 | 670.6 | 8.90 | 226.1 | 5.50 | 139.7 |
| J225X | A01 | 22.70 | 577 | 10.93 | 278 | 7.70 | 196 |
| J225Y | A01 | 22.70 | 577 | 10.93 | 278 | 7.70 | 196 |
| L600AWK | A01 | 57.50 | 1461 | 20.38 | 518 | 8.25 | 210 |
| L600AWKVW | A01 | 57.50 | 1461 | 20.38 | 518 | 8.25 | 210 |
| L600AWKMC | A01 | 57.50 | 1461 | 20.38 | 518 | 8.25 | 210 |
| L1200S | A01 | 51.88 | 1818 | 20.25 | 514 | 7.75 | 197 |
| LA400AWK | E05 | 42.25 | 1073 | 13.75 | 349 | 7.25 | 184 |
| LA400DS | E05 | 42.25 | 1073 | 13.75 | 349 | 7.25 | 184 |
| LA400F | E03 | 45.63 | 1159 | 16.50 | 419 | 6.50 | 165 |
| LA400R | E03 | 44.00 | 1118 | 15.38 | 391 | 7.88 | 200 |
| LA400S | E03 | 44.50 | 1130 | 15.38 | 391 | 6.50 | 165 |
| LA400LS | A01 | 27.40 | 696.0 | 15.40 | 391.2 | 6.625 | 168.3 |
| M800S | A01 | 40-3/8 | 1025.52 | 21 | 533.4 | 9-3/4 | 247.65 |
| M800R | A01 | 40-3/8 | 1025.52 | 21 | 533.4 | 9-3/4 | 247.65 |
| M800DS | A01 | 40-7/8 | 1036.96 | 20-3/4 | 527.05 | 9-1/2 | 241.3 |
| M800SS | A01 | 40-7/8 | 1036.96 | 20-3/4 | 527.05 | 9-1/2 | 241.3 |
| M800AWK | A01 | 40-7/8 | 1036.96 | 20-3/4 | 527.05 | 9-1/2 | 241.3 |
| P1200S | A01 | 52-1/8 | 1323.98 | 21 | 533.4 | 9-3/4 | 247.65 |
| P1200R | A01 | 52-1/8 | 1323.98 | 21 | 533.4 | 9-3/4 | 247.65 |
| P1200AWK | A01 | 53 | 1346.20 | 20-3/4 | 527.05 | 9-1/2 | 241.3 |
| Q22200NRB | E05 | 23.38 | 594 | 7.63 | 194 | 4.75 | 121 |
| Q22200NS | E05 | 23.13 | 588 | 7.63 | 194 | 4.25 | 108 |
| Q23225NF | E05 | 26.25 | 667 | 9.88 | 251 | 4.75 | 121 |
| Q23225NRB | E05 | 26.25 | 667 | 9.88 | 251 | 5.50 | 140 |
| Q23225NS | E05 | 26.25 | 667 | 9.88 | 251 | 4.75 | 121 |

