

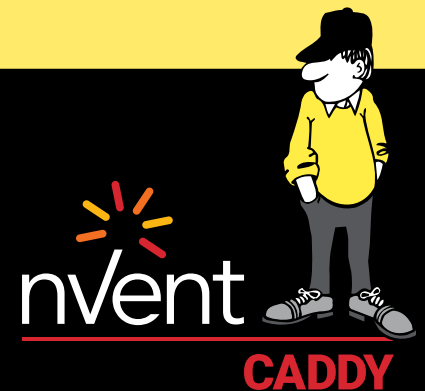

CONNECT AND PROTECT

nVent CADDY Rod Lock

Threaded Rod Mounting System



nVent CADDY Rod Lock

Prefabrication is the process that allows for parts to arrive at a job site preassembled. More and more, contractors are leveraging the efficiencies provided by prefabrication, including:

- cost savings
- better time management
- safer installations

These benefits apply to a variety of projects, regardless of size or scope.

Historically, complex assemblies were built on-site at the location where they were to be mounted. Installers, therefore, required constant access to the job site in order to keep a project moving according to schedule.

With prefabrication, assembly is completed in a space devoted to the production and storage of components. By completing these tasks off-site, contractors can mass-produce assemblies used in similar projects, and on-site installers can focus exclusively on mounting the finished product.

Today, contractors can leverage a range of emerging solutions that allow for new and unique ways to prefabricate. While the process may require a new approach to processes such as purchasing, creating and installing assemblies—as well as hardware used during the mounting of a finished piece—prefabrication yields countless benefits.

In today's competitive construction market, contractors must provide quality work while lowering labor costs and project time and adhering to safety standards.

Rod Lock "Push-to-Install" technology allows prefabrication of complex assemblies off-site or on the ground. Large assemblies can simply then be lifted and locked into place.

The process requires less time on the job site, allowing for more tasks to be completed in a controlled off-site facility. As a result, prefabrication reduces installation costs, enables schedule flexibility and improves safety.

While results may vary based on specific product and application, studies have shown the unique features of the Rod Lock system help reduce the installation time of threaded rod by up to **52 percent** compared to conventional fasteners.

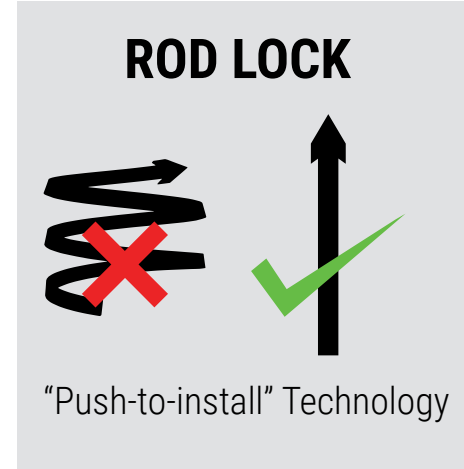

"Prefabrication is vital to this project both to deal with the delays, and also to help manage the materials. [...] And, we expect labor savings by moving work into the controlled environment of the shop."

Will Vranich - Smith & Oby
(United States)

For both contractors and their clients, prefabrication offers a host of benefits—chief among these is time savings. In fact, prefabrication makes schedule compression possible by as much as 18 percent. While this includes the ability to complete a job more quickly, other time-related perks should be noted.

MORE LEAD TIME

Contractors can plan for projects sooner, and installers can prepare pieces in advance at the prefab shop. They can then quickly install assemblies, requiring less time at the job site.

LESS DOWNTIME

Workers can fill gaps in their schedules with projects in the prefab shop. Contractors and installers can rely on more consistent and efficient work schedules.

SCHEDULE FLEXIBILITY

To combat restrictions of job site schedules or city ordinances, a majority of prefab work can be completed off-site. Prefab shops can run anytime day or night, allowing for quicker turnaround and enabling the contractor to have greater control over the team's project schedule.

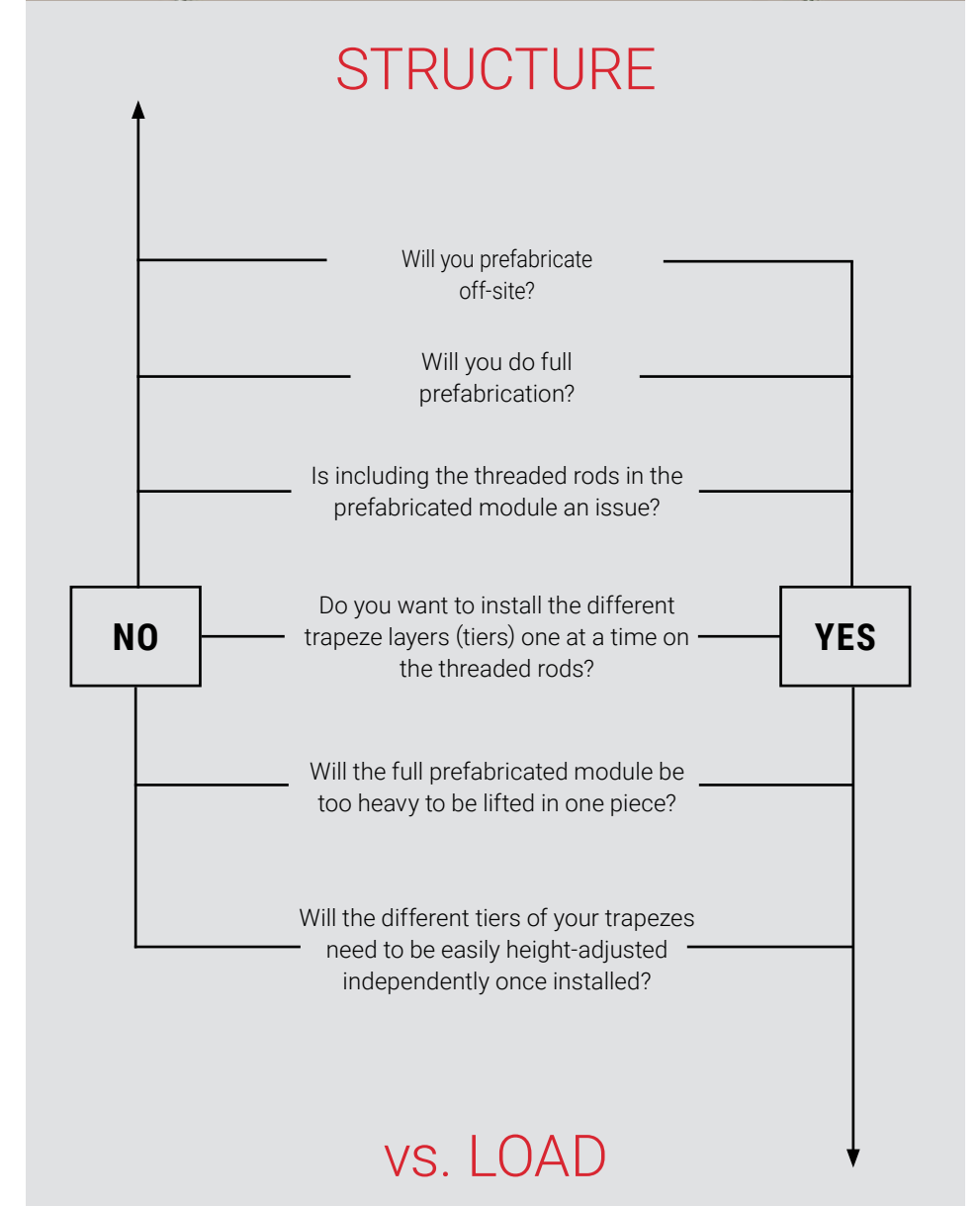

Internal studies have indicated time savings of up to 69% with one person installing a 2-tier trapeze with Rod Lock Strut (compared to traditional installation).





Structure vs. Load

Having the right hardware can make a prefabrication assembly even more efficient during installation.

Structural attachments are ideal for on-site (partial) prefabrication projects, reducing the time spent in the air. Additionally, they

are height-adjustable at the structure, but different trapezes can be more difficult to readjust. These attachments are most often used on heavier modules.

Supports are ideal for off-site (full) prefabrication projects. They are height-

adjustable at the load, and the height for each tier can easily be altered. These are lighter modules, offering easier transportation. Additionally, they allow for prefab using fire-rating structural attachments.

Installation at Structure

| | Beam Clamp (1/8" - 3/8") | Beam Clamp, Thick Flange (3/8" - 3/4") | Anchor Screw | Bar Joist Hanger | | Metal Decking Preset Anchor | Plywood Form Preset Anchor | L-Bracket | Coupler | Coupler with Rod |
|---|--------------------------|--|--------------|------------------|--|-----------------------------|----------------------------|-----------|---------|------------------|
| Rod Lock Product | | | | | | | | | | |
| Page | 14 | 14 | 15 | 15 | | 16 | 16 | 18 | 17 | 17 |
| Application | | | | | | | | | | |
| Is the assembly being attached to concrete - wall? | | | | | | | | ✓ | | |
| Is the assembly being attached to concrete - ceiling (pre-pour)? | | | | | | ✓ | ✓ | | | |
| Is the assembly being attached to concrete - ceiling (post-pour)? | | | ✓ | | | | | | | |
| Is the assembly being attached to I-Beam or flange? | ✓ | ✓ | | | | | | | | |
| Is the assembly being attached to Bar-Joist? | | | | ✓ | | | | | | |
| Is the assembly being attached to existing/already installed threaded rods or male anchors? | | | | | | | | | ✓ | |
| Is the assembly being attached to existing/already installed female anchors? | | | | | | | | | | ✓ |



Conduit / Pipe Rack Installation

KNOWN ROD SPACING

When installing to a specific rod spacing, the best option is Rod Lock Strut. The conduit runs can be easily lifted and locked into place using Rod Lock "Push-to-Install" technology. It is available for widths of 16-52", and ordered in advance to the desired pre-cut length – eliminating the need for handling long lengths of strut and all the cumbersome activities associated to it.

UNKNOWN ROD SPACING

To install with unknown rod spacing, contractors should use the Rod Lock Telescoping Strut Replacement. The part has Rod Lock hardware at each end of the bar, but can telescope between 12.5-20", and eliminates the need for cutting strut.

RETROFITTING

When facing an existing installation where pipe runs need to be added to an already installed (multi-tiered) trapeze, the TSR1220R is the ideal solution. This retrofit version of the Telescopic Strut Replacement can be placed above (or in between) existing trapezes and held in place with four SN Nuts. This particular version of the TSR1220 doesn't work with off-site fabrication, the TSR1220R must be installed on the threaded rods first and then the pipe can be attached to it.

"As a specialist for drainage pipe systems we count on ROD LOCK when it comes to install roof drainage systems. I, as a project leader, appreciate most the time- and with that the cost-savings achieved thanks to the use of "Rod Lock."

Karl Konarzewski - DWD Group GmbH (Germany)















The spacing between conduits across the channel needs to be the same so that they meet up with each other when the individual runs are installed. It is recommended that installers use custom wooden jigs with notches at the spacing for each piece. They can be easily made on the jobsite with pieces of wood and customized for individual situations.





The channel is laid next to the jig and the conduit is attached to it. A variety of nVent CADDY fasteners can be used to hold the conduit to the channel. This process is repeated based on the number of runs needed for the total length of conduit on the project.

The threaded rod is attached at structure in advance.





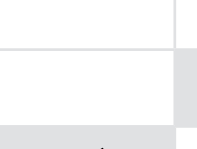







| | | Channel Nut | Strut Nut |
|--------------------|---|---|---|
| | | Rod Lock Product | Page |
| Light Installation | Rod Lock Product |  |  |
| | Page | 22 | 23 |
| Application |  |  | |
| | Accommodates strut with its open side facing down | ✓ | ✓ |
| | Accommodates large variances in threaded rod location | ✓ | |
| | Height adjustable | | ✓ |
| | Ability to lock the "push-to-install" system | | ✓ |

| | | Channel Nut | Strut Nut | Strut | Telescoping Strut Replacement |
|----------------------------------|---|---|---|---|---|
| | | Rod Lock Product | Page | Page | Page |
| Conduit / Pipe Rack Installation | Rod Lock Product |  |  |  |  |
| | Page | 22 | 23 | 21 | 20 |
| Application |  |  |  |  | |
| | Out-of-the-box support | | | ✓ | ✓ |
| | Accommodates strut with its open side facing down | ✓ | | | |
| | Accommodates strut with its open side facing up | ✓ | ✓ | ✓ | ✓ |
| | Accommodates large variances in threaded rod location | ✓ | | | ✓ |
| | Height adjustable | | ✓ | ✓ | ✓ |
| | Ability to lock the "push-to-install" system | | ✓ | ✓ | ✓ |

| | | L-Bracket | Channel Nut | Strut Nut |
|-----------------------------------|---|---|---|---|
| | | Rod Lock Product | Page | Page |
| Prefabricated Module Installation | Rod Lock Product |  |  |  |
| | Page | 18 | 22 | 23 |
| Application |  |  |  | |
| | Compatible with strut frame | | ✓ | ✓ |
| | Compatible with non-strut frame | ✓ | | ✓ |
| | No extra hardware needed | | ✓ | ✓ |
| | Accommodates strut with its open side facing down | | ✓ | |
| | Accommodates large variances in threaded rod location | ✓ | ✓* | ✓* |
| | Height adjustable | ✓ | | ✓ |
| | Ability to lock the "push-to-install" system | ✓ | | ✓ |

* For non-strut frame only. Holes must be drilled in frame.











Cable Tray Installation

| | L-Bracket | Wire Basket Support Clip | Universal Tray Support | Strut | Telescoping Strut Replacement | | Channel Nut | Strut Nut |
|---|---|---|--|---|---|--|---|---|
| Rod Lock Product |  |  |  |  |  | |  |  |
| Page | 18 | 26 | 27 | 21 | 20 | | 22 | 23 |
| Application |  |  |  |  |  | |  | |
| Basket tray | | ✓ | ✓ | ✓ | ✓ | | ✓ | ✓ |
| Perforated tray | ✓ | | ✓ | ✓ | ✓ | | ✓ | ✓ |
| Cable ladder | ✓ | | | ✓ | ✓ | | ✓ | ✓ |
| Lay-in cable / wire | | | ✓ | | | | | |
| Multi-tier assemblies | ✓ | ✓ | ✓ | ✓ | ✓ | | ✓ | ✓ |
| Out-of-the-box support | | ✓ | ✓ | ✓ | ✓ | | | |
| Material cost independent of tray width | ✓ | ✓ | | | ✓ | | | |
| No restriction on tray width | ✓ | ✓ | | ✓ | | | ✓ | ✓ |
| Standard version available for using Rod Lock technology at the structure | ✓ | | ✓ | | ✓ | | | |
| Accommodates 1/2" threaded rod | | | | ✓ | | | | |
| Accommodates strut with open side facing down | | | | | | | ✓ | ✓ |
| Accommodates large variances in threaded rod locations | | | | | ✓ | | ✓ | ✓ |
| Height adjustable | ✓ | ✓ | ✓ | ✓ | ✓ | | | |
| Ability to lock the "push-to-install" system | ✓ | ✓ | ✓ | ✓ | ✓ | | | |





Air Duct Installation

| | Channel Nut | Strut Nut | Bottom-Mount Duct Bracket | | Bottom-Mount Duct Bracket, Narrow | Strut | Telescoping Strut Replacement |
|--|--|---|--|--|--|--|---|
| Rod Lock Product |  |  |  | |  |  |  |
| Page | 22 | 23 | 19 | | 19 | 21 | 20 |
| Application |  | |  | |  |  | |
| Out-of-the-box support | | | ✓ | | ✓ | ✓ | ✓ |
| Material cost independent of duct width | | | ✓ | | ✓ | | ✓ |
| Material cost independent of duct height | | | | | | | |
| Recognized by SMACNA | | | ✓ | | ✓ | | |
| Support duct wider than 60" without engineering analysis | ✓ | ✓ | | | | ✓ | |
| Install hanger to the duct on the ground | | ✓ | ✓ | | ✓ | | |
| Does not penetrate the duct with screws | ✓ | ✓ | | | | ✓ | ✓ |
| Accommodates strut with open side facing down | ✓ | | | | | | |
| Accommodates large variances in threaded rod locations | ✓ | | ✓ | | | | ✓ |
| Height adjustable | | ✓ | ✓ | | ✓ | ✓ | ✓ |
| Ability to lock the "push-to-install" system | | ✓ | ✓ | | ✓ | ✓ | ✓ |





AIR DUCT INSTALLATION

Rectangular duct can be prefabricated two ways: attaching directly to the duct or attaching the duct to strut. In both situations, Rod Lock "push-to-install" technology enables easy installation of preassembled pieces.

When attaching directly to the duct, installers should screw Rod Lock Duct Brackets into the side of the duct. Threaded rod should be attached at structure, and the duct assemblies are easily lifted and locked into place.



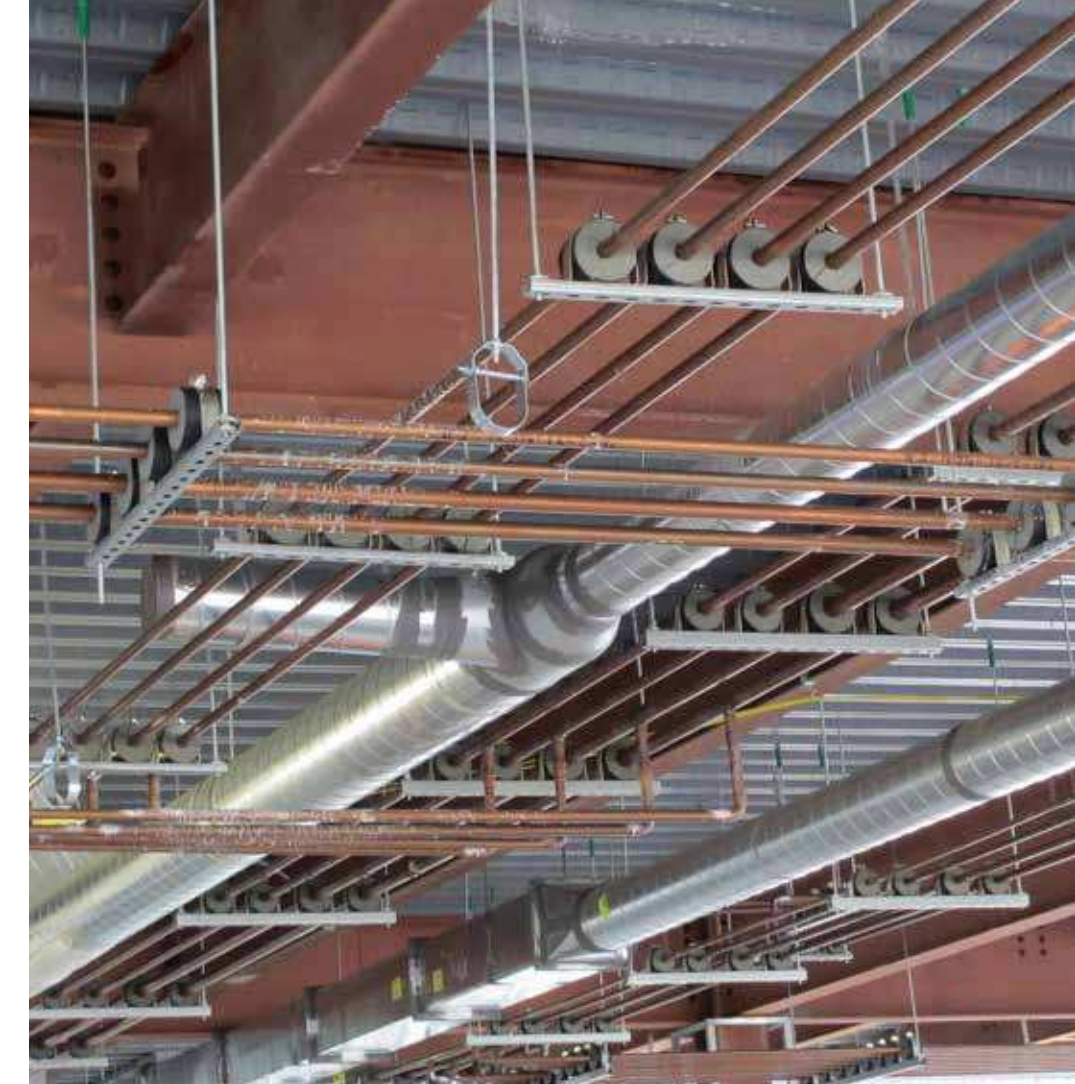

In strut mounted applications, duct is attached to Rod Lock Strut and the strut is pushed onto the threaded rods.

Goal-post Installation

| | SNSW Flanged Nut | Nut | Strut | Telescopic Strut Replacement | | Channel Nut | Strut Nut |
|--|---|--|---|---|--|--|--|
| Rod Lock Product |  |  |  |  | |  |  |
| Page | 25 | 23 | 21 | 20 | | 22 | 23 |
| Application |    |    |  | | |   |   |
| Out-of-the-box support | | | ✓ | ✓ | | | |
| Material cost independent of goal-post length | | | | ✓ | | | |
| No loose hardware when installed onto strut channel | | | ✓ | ✓ | | ✓ | ✓ |
| Accommodates strut with open side facing down | ✓ | ✓ | | | | ✓ | |
| Accommodates large variances in threaded rod locations | | | | ✓ | | ✓ | |
| Height adjustable | ✓ | ✓ | ✓ | ✓ | | | ✓ |
| Ability to lock the "push-to-install" system | | | ✓ | ✓ | | | ✓ |
| "Push-to-install" system | | ✓ | ✓ | ✓ | | ✓ | ✓ |
| Easy and fast uninstallation | ✓ | | | | | | |



Retrofit Installation

| | TSR1220R + SN Nuts | ISSP + SN Nuts |
|---|---|---|
| Product |  |  |
| Page | 24 | 24 |
| Application |  |  |
| Accommodates strut with open side facing down | ✓ | |
| Accommodates strut with open side facing up | ✓ | ✓ |
| Suitable for trapeze with threaded rod >20" | | ✓ |
| Material cost independent of trapeze length | ✓ | |
| Height adjustable | ✓ | ✓ |
| Tool-free | ✓ | |



Rod Lock Beam Clamps

- Prefabricated assemblies easily lift and lock into place, helping to save time and money
- Easy "push-to-install" design allows installers to simply push the threaded rod through the mounting hole, instantly holding it in position
- Lock nut can be finger tightened, locking the rod in place
- Works with slightly damaged threads and minor burrs on the threaded rod
- Conforms with Federal Specification WW-H-171 (Type 23), Manufacturers Standardization Society ANSI®/MSS-SP-58 (Type 19 and 23)

Fast, easy solution for attaching threaded rod assemblies to metal beam structures.



ROD LOCK BEAM CLAMP

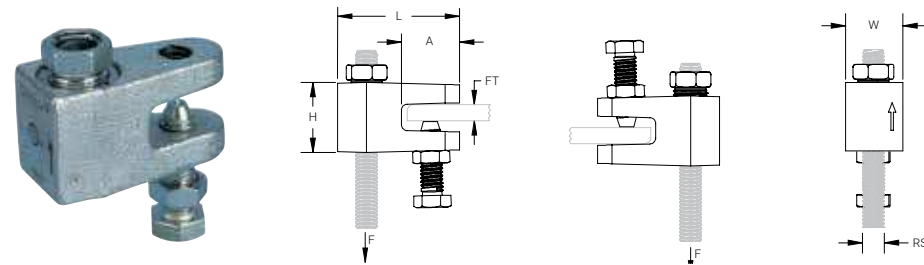

"I would never buy a normal beam clamp again after seeing this. It is so much faster to install this."

Sean Daley - Total Electric (United States)

Material: Cast Iron
Finish: Electrogalvanized



| Part Number | Rod Size RS | Flange Thickness FT | Height H | Length L | Width W | A | Static Load 1 F1 | Static Load 2 F2 |
|-------------|-------------|---------------------|----------|----------|---------|-------|------------------|------------------|
| CRLB37EG | 3/8" | 1/8" - 3/8" | 1 3/16" | 2.06" | 1" | 0.98" | 250 lb | 500 lb |

For use on plain and electro zinc plated hardware only.

Static Load 1 represents 1/8" to 3/16" (3 mm to 5 mm) flange thickness.

Static Load 2 represents 1/4" to 3/8" (6 mm to 10 mm) flange thickness. Recognizing that torque wrenches are generally not used or available on many job sites, the setscrew should be tightened so it contacts the I-beam and then an additional 1/2 turn added.

ROD LOCK BEAM CLAMP, THICK FLANGE

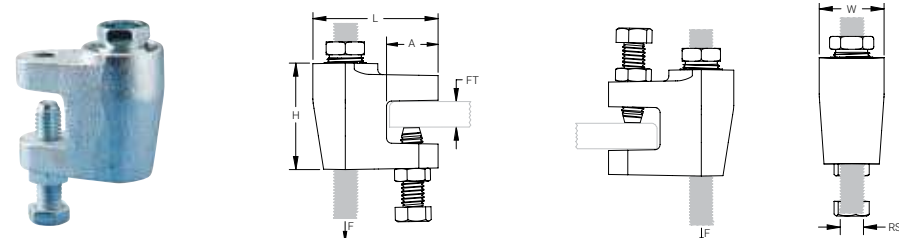

Material: Cast Iron
Finish: Electrogalvanized



| Part Number | Rod Size RS | Flange Thickness FT | Height H | Length L | Width W | A | Static Load 2 F2 |
|-------------|-------------|---------------------|----------|----------|---------|----|------------------|
| CRLB50EG | 1/2" | 3/8" - 3/4" | 2.1" | 2.4" | 1.3" | 1" | 1,100 lb |

For use on plain and electro zinc plated hardware only.

FM® Approved in the bottom mount orientation only.

Recognizing that torque wrenches are generally not used or available on many job sites, the setscrew should be tightened so it contacts the I-beam and then an additional 1/2 turn added.

Rod Lock Bar Joist Hanger

- Easily installs from underneath the bar joist
- Plastic protection cap prevents dirt or structural coatings from obstructing the "push-to-install" mechanism
- Prefabricated assemblies easily lift and lock into place, helping to save time and money
- Easy "push-to-install" design allows installers to simply push the threaded rod through the mounting hole, instantly holding it in position
- Works with slightly damaged threads and minor burrs on the threaded rod

Fast, easy solution for attaching threaded rod assemblies to bar joists.

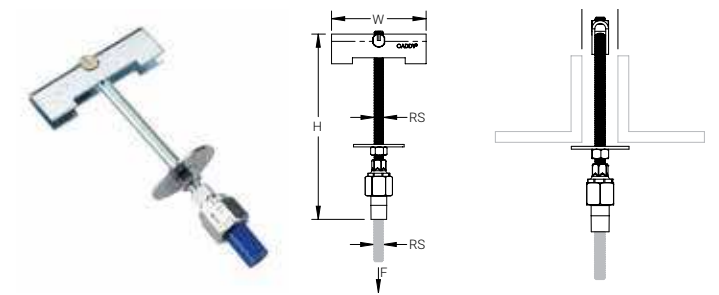

Material: Steel
Finish: Electrogalvanized
Static Load Safety Factor: 3.5:1

| Part Number | Rod Size RS | Height H | Width W | A | Wrench Size 1 | Wrench Size 2 | Static Load F |
|-------------|-------------|----------|---------|---------------|---------------|---------------|---------------|
| CRLJ37EG | 3/8" | 7.4" | 3.7" | 5/8" - 1 1/4" | 9/16" | 15/16" | 1,000 lb |

Wrench Size 1 represents hex nut size used to tighten to bar joist. Wrench Size 2 represents Rod Lock hex nut size.

Rod Lock Anchor Screw

- For use with concrete and solid brick
- Prefabricated assemblies easily lift and lock into place, helping to save time and money
- Works with slightly damaged threads and minor burrs on the threaded rod

Push-to-install threaded rod support for concrete or brick.

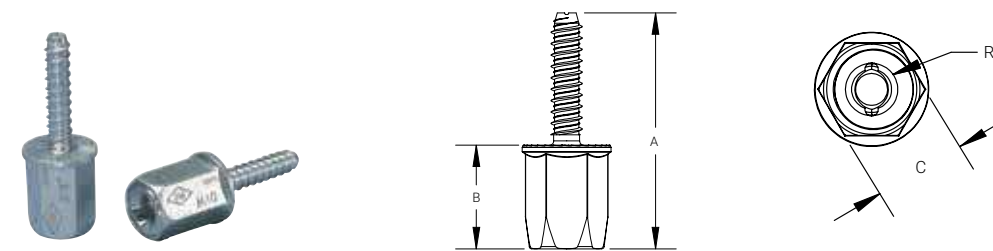

Material: Steel
Finish: Electrogalvanized



| Part Number | Rod Size RS | A | B | C | Drill Bit Diameter | Drill Hole Depth | Static Load F |
|-------------|-------------|--------|--------|------|--------------------|------------------|---------------|
| CRLA37EG | 3/8" | 2 7/8" | 1 1/4" | 7/8" | 5/16" | 2" | 652 lb |

For use on plain and electro zinc plated hardware only.

Tested in 3,000 psi (20.68 MPa) concrete and soft or hard wood with a 9/32" pilot hole.

Rod Lock Preset Anchors

- Eliminate overhead drilling into building structure – Rod Lock Preset Anchors are cast in place
- Easy “push-to-install” design allows installers to simply push the threaded rod through the mounting hole, instantly holding it in position
- Works with slightly damaged threads and minor burrs on the threaded rod
- Prefabricated assemblies easily lift and lock into place, helping to save time and money
- Plastic flange acts as insert locator when the forms are removed
- Rod Lock Preset Anchors have a pending evaluation to AC446, Acceptance Criteria for Headed Cast-In Specialty Inserts in Concrete

Preset anchors for concrete that allow complex prefabricated threaded rod assemblies to be easily pushed into place.



ROD LOCK METAL DECKING PRESET ANCHOR

- Set in place through a drilled hole in the metal decking before the concrete is poured
- Can be used in lower and upper flute installations

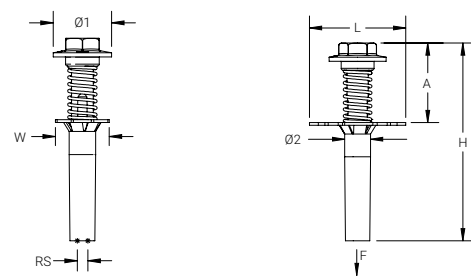

Material: Steel
Finish: Electrogalvanized

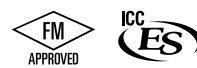

| Part Number | Rod Size RS | Diameter 1 Ø1 | Diameter 2 Ø2 | Height H | Length L | Width W | A | Drill Bit Diameter | Static Load F |
|-------------|-------------|---------------|---------------|----------|----------|---------|------|--------------------|---------------|
| CRLM37EG | 3/8" | 1.65" | 0.7" | 5.6" | 2.8" | 1 1/2" | 2.3" | 3/4" | 830 lb |
| CRLM50EG | 1/2" | 1.95" | 0.8" | 5.7" | 2.8" | 1 1/2" | 2.4" | 7/8" | 830 lb |

ROD LOCK PLYWOOD FORM PRESET ANCHOR

- Nails hold the anchor in place during the pour and easily break off with a strike of a hammer once the plywood forms are removed

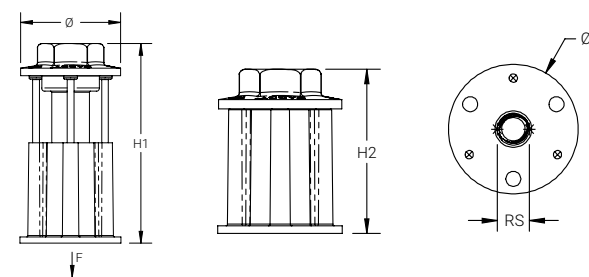

Material: Steel
Finish: Electrogalvanized



| Part Number | Rod Size RS | Diameter Ø | Height 1 H1 | Height 2 H2 | Static Load F |
|-------------|-------------|------------|-------------|-------------|---------------|
| CRLW37EG | 3/8" | 1.65" | 3.2" | 2.4" | 1,407 lb |
| CRLW50EG | 1/2" | 1.90" | 3.3" | 2.5" | 1,618 lb |

Rod Lock Coupler

- Joins two sections of threaded rod by an easy “push-to-install” mechanism
- Can be easily installed at the end of a threaded rod, or to any existing male thread
- Plastic protection cap prevents dirt or structural coatings from obstructing the “push-to-install” mechanism
- Prefabricated assemblies easily lift and lock into place, helping to save time and money
- Works with slightly damaged threads and minor burrs on the threaded rod

An ideal replacement for traditional threaded rod couplers in applications where traditional Rod Lock structural attachments are unsuitable due to the application of structural coatings that would obstruct the push-to-install mechanism.

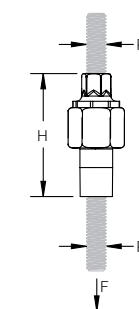

Material: Steel
Finish: Electrogalvanized
Static Load Safety Factor: 3.5:1

ROD LOCK METAL DECKING PRESET ANCHOR

| Part Number | Rod Size RS | Height H | Wrench Size 1 | Wrench Size 2 | Static Load F |
|-------------|-------------|----------|---------------|---------------|---------------|
| CRLC37EG | 3/8" | 2.4" | 1/2" | 15/16" | 1,000 lb |

Wrench Size 1 represents hex size used to tighten to threaded rod from structure. Wrench Size 2 represents Rod Lock hex nut size.

Rod Lock Coupler with Rod

- Easily installs into any traditional structural threaded rod attachment
- Allows simple installation of threaded rod assemblies by an easy “push-to-install” mechanism
- Plastic protection cap prevents dirt or structural coatings from obstructing the “push-to-install” mechanism
- Prefabricated assemblies easily lift and lock into place, helping to save time and money
- Works with slightly damaged threads and minor burrs on the threaded rod

A coupler attached to precut lengths of threaded rod, allowing for installation in to any traditional threaded rod attachment including beam clamps, preset concrete anchors, and post drill concrete anchors.

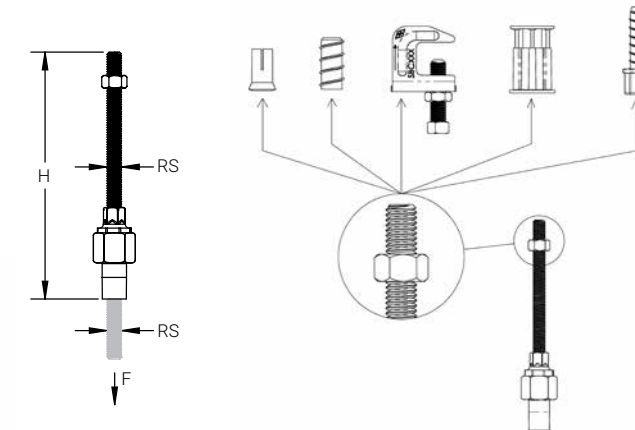

Material: Steel
Finish: Electrogalvanized
Static Load Safety Factor: 3.5:1

| Part Number | Rod Size RS | Height H | Wrench Size 1 | Wrench Size 2 | Static Load F |
|-------------|-------------|----------|---------------|---------------|---------------|
| CRLC37L1 | 3/8" | 6.3" | 9/16" | 15/16" | 1,000 lb |

Wrench Size 1 represents hex nut size used to tighten to structural attachment. Wrench Size 2 represents Rod Lock hex nut size.

Rod Lock L-Bracket

- Easy "push-to-install" design allows installers to simply push the threaded rod through the mounting hole, instantly holding it in position
- Prefabricated assemblies easily lift and lock into place, helping to save time and money
- Multiple attachment holes support the use of either self-drilling screws or bolts, offering installation options for concrete, wood, and steel structures
- Lock nut can be finger tightened, locking the rod in place
- Integrated adjustment nut enables fine tuning the system height up or down
- Extremely useful in tight spaces where wrenches are difficult to use
- Conforms with Federal Specification WW-H-171 (Type 23), Manufacturers Standardization Society ANSI®/MSS-SP-58 (Type 19 and 23)

A versatile solution that can be used as a **Structural Attachment** or as a **Load Attachment**:

- At Structure - Attach to concrete/wood beam or to a wall
- At Load - Attach to the side of cable ladder, perforated tray, prefabricated modules, etc.

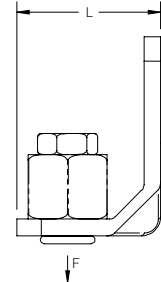
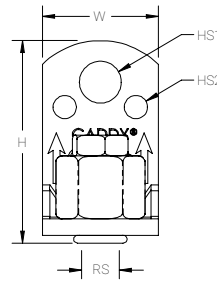

Material: Cast Iron
Finish: Electrogalvanized



| Part Number | Rod Size RS | Height H | Length L | Width W | Hole Size 1 (HS1) | Hole Size 2 (HS2) | Wrench Size | Static Load F |
|-------------|-------------|----------|----------|---------|-------------------|-------------------|-------------|---------------|
| CRLL37EG | 3/8" | 2.41" | 1.7" | 1.4" | 0.51" | 0.28" | 11/16" | 700 lb |

Follow fastener manufacturer's recommended shear and pull-out strength when fastening to the structure. Fastener not included. Install in accordance with applicable code.

Rod Duct Brackets

- Easy "push-to-install" design allows installers to simply push the threaded rod through the mounting hole, instantly holding it in position
- Ready to use out of the box and eliminates the need for cutting and preparing sections of strut, angle iron, or strap
- Integrated adjustment nut enables fine tuning the system height up or down
- Lock nut can be finger tightened, locking the rod in place
- Ideal for modular assembly – allows attachment of brackets to sections of duct while safely on the ground
- Extremely useful in tight spaces where wrenches are difficult to use
- Includes self-tapping sheet metal screws to attach bracket to duct

Elegant solutions to facilitate pre-fabrication of rectangular duct while eliminating the need for strut.



ROD LOCK BOTTOM-MOUNT DUCT BRACKET

- Slotted holes in bracket allow for horizontal adjustment of the bracket relative to the duct

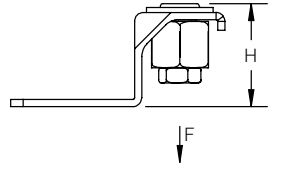
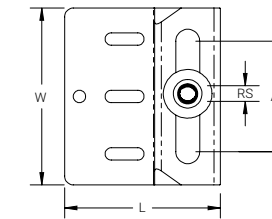

Material: Steel
Finish: Electrogalvanized



| Part Number | Rod Size RS | Height H | Length L | Width W | A | Static Load F |
|-------------|-------------|----------|----------|---------|--------|---------------|
| CRLD37BEG | 3/8" | 1.7" | 3 1/2" | 4" | 2 1/2" | 650 lb |

ROD LOCK BOTTOM-MOUNT DUCT BRACKET, NARROW

- Non-slotted bracket allows for attachment after the final horizontal position of the duct is achieved

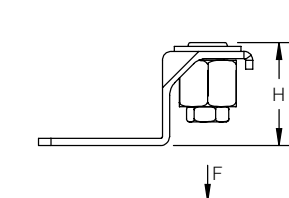
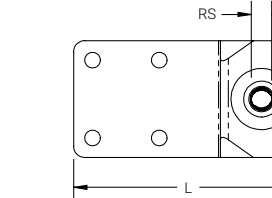

Material: Steel
Finish: Electrogalvanized



| Part Number | Rod Size RS | Height H | Length L | Width W | Static Load F |
|-------------|-------------|----------|----------|---------|---------------|
| CRLD37BNEG | 3/8" | 1.9" | 4.1" | 2.1" | 1,400 lb |

Rod Lock Telescoping Strut Replacement

- Easy "push-to-install" design allows installers to simply push the threaded rod through the mounting hole, instantly holding it in position
- Telescopes to the desired length and is locked in place by snapping closed a spring retainer clip
- Standard strut profile runs the entire length of the part, allowing most standard fittings to be placed anywhere between the rods
- Allows installers to prefabricate complex assemblies and quickly lift and lock them into place
- Lock nut can be finger tightened, locking the rod in place
- Allows for the quick creation, installation, and adjustment of multi-level trapeze assemblies
- Captive threaded nuts enable fastening to threaded rod supports without loose parts
- Integrated ruler displays space between hanger rods in inches and centimeters
- Supports up to six 2" (50 DN) conduits, six 2" (50 DN) water filled pipes at 10' (3 m) spacing, or up to 18" (450 mm) cable tray
- Conduit can be supported on the top and bottom, eliminating the need for double sided strut
- Conduit and pipe can be placed directly on the strut profile, saving vertical space in buildings with limited room for installation

Extremely fast and simple solution for multi-tiered trapeze installations. The Telescoping Strut Replacement is compatible with all of your favorite strut accessories.

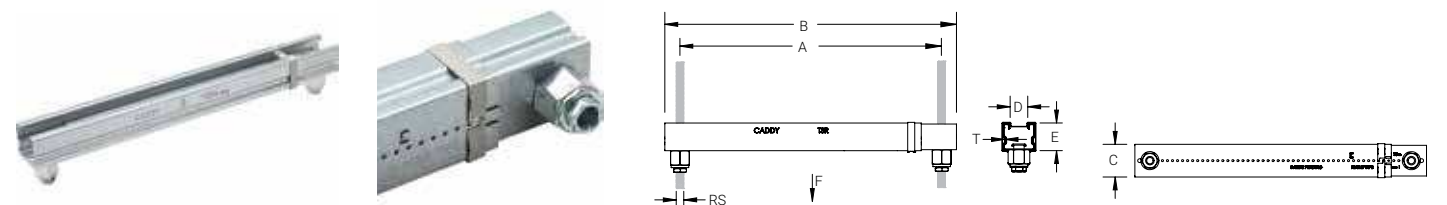

Material: Steel
Finish: Pregalvanized

| Part Number | Rod Size RS | Thickness T | A | B | C | D | E | Static Load 1 F1 | Static Load 2 F2 |
|-------------|-------------|-------------|---------------|---------------|--------|------|--------|------------------|------------------|
| TSR122038RL | 3/8" | 0.04" | 12 1/2" - 20" | 14" - 21 1/2" | 1 5/8" | 7/8" | 1 3/8" | 300 lb | 200 lb |

Static Load 1 represents a distributed load for 12" - 20" (300 - 500 mm) installations and a point load for 12" - 16" (300 - 400 mm) installations.

Static Load 2 represents a point load for 16" - 20" (400 - 500 mm) installations.

Rod Lock Strut

- Allows for the quick creation, installation, and adjustment of multi-level trapeze assemblies
- Ready to use out of the box and eliminates the need for cutting and preparing sections of strut
- Easy "push-to-install" design allows installers to simply push the threaded rod through the mounting hole, instantly holding it in position
- Integrated adjustment nut enables fine tuning the system height up or down
- Accommodates slight variances in rod-to-rod position of the trapeze
- No loose parts or special tools needed for installation
- Lock nut can be finger tightened, locking the rod in place
- Works with all accessories that fit standard A or C type strut channels

Prefabricated sections of strut with Rod Lock technology designed to replace traditional strut in a wide variety of applications, such as cable tray, duct, and conduit/pipe trapeze.



"Internal studies have indicated time savings of up to 69% when installing a two-tier trapeze with one person" (compared to traditional installation).

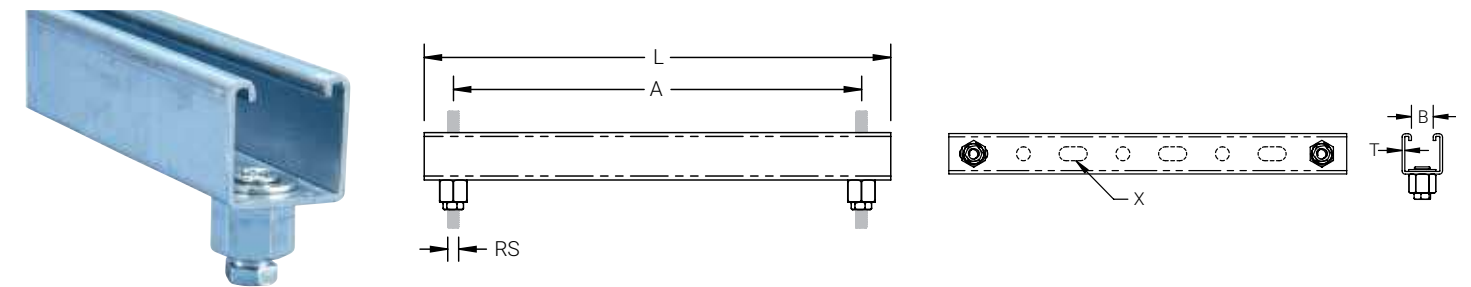

Material: Steel
Finish: Electrogalvanized; Pregalvanized

| Part Number | Rod Size RS | Strut Type | Length L | Thickness T | A | B | X |
|-------------|-------------|---------------------|----------|-------------|-----|------|----------------|
| CRLP237L14 | 3/8" | A (1 5/8" x 1 5/8") | 16" | 12 GA | 14" | 7/8" | 9/16" x 1 1/8" |
| CRLP237L18 | 3/8" | A (1 5/8" x 1 5/8") | 20" | 12 GA | 18" | 7/8" | 9/16" x 1 1/8" |
| CRLP237L22 | 3/8" | A (1 5/8" x 1 5/8") | 24" | 12 GA | 22" | 7/8" | 9/16" x 1 1/8" |
| CRLP237L26 | 3/8" | A (1 5/8" x 1 5/8") | 28" | 12 GA | 26" | 7/8" | 9/16" x 1 1/8" |
| CRLP237L38 | 3/8" | A (1 5/8" x 1 5/8") | 40" | 12 GA | 38" | 7/8" | 9/16" x 1 1/8" |
| CRLP237L50 | 3/8" | A (1 5/8" x 1 5/8") | 52" | 12 GA | 50" | 7/8" | 9/16" x 1 1/8" |
| CRLP137L14 | 3/8" | C (13/16" x 1 5/8") | 16" | 14 GA | 14" | 7/8" | 9/16" x 1 1/8" |
| CRLP137L18 | 3/8" | C (13/16" x 1 5/8") | 20" | 14 GA | 18" | 7/8" | 9/16" x 1 1/8" |
| CRLP137L22 | 3/8" | C (13/16" x 1 5/8") | 24" | 14 GA | 22" | 7/8" | 9/16" x 1 1/8" |
| CRLP137L26 | 3/8" | C (13/16" x 1 5/8") | 28" | 14 GA | 26" | 7/8" | 9/16" x 1 1/8" |
| CRLP137L38 | 3/8" | C (13/16" x 1 5/8") | 40" | 14 GA | 38" | 7/8" | 9/16" x 1 1/8" |
| CRLP250L14 | 1/2" | A (1 5/8" x 1 5/8") | 16" | 12 GA | 14" | 7/8" | 9/16" x 1 1/8" |
| CRLP250L18 | 1/2" | A (1 5/8" x 1 5/8") | 20" | 12 GA | 18" | 7/8" | 9/16" x 1 1/8" |
| CRLP250L22 | 1/2" | A (1 5/8" x 1 5/8") | 24" | 12 GA | 22" | 7/8" | 9/16" x 1 1/8" |
| CRLP250L26 | 1/2" | A (1 5/8" x 1 5/8") | 28" | 12 GA | 26" | 7/8" | 9/16" x 1 1/8" |
| CRLP250L38 | 1/2" | A (1 5/8" x 1 5/8") | 40" | 12 GA | 38" | 7/8" | 9/16" x 1 1/8" |
| CRLP250L50 | 1/2" | A (1 5/8" x 1 5/8") | 52" | 12 GA | 50" | 7/8" | 9/16" x 1 1/8" |
| CRLP150L14 | 1/2" | C (13/16" x 1 5/8") | 16" | 14 GA | 14" | 7/8" | 9/16" x 1 1/8" |
| CRLP150L18 | 1/2" | C (13/16" x 1 5/8") | 20" | 14 GA | 18" | 7/8" | 9/16" x 1 1/8" |
| CRLP150L22 | 1/2" | C (13/16" x 1 5/8") | 24" | 14 GA | 22" | 7/8" | 9/16" x 1 1/8" |
| CRLP150L26 | 1/2" | C (13/16" x 1 5/8") | 28" | 14 GA | 26" | 7/8" | 9/16" x 1 1/8" |
| CRLP150L38 | 1/2" | C (13/16" x 1 5/8") | 40" | 14 GA | 38" | 7/8" | 9/16" x 1 1/8" |

Rod Lock Strut must be installed with the open side of the channel facing up. For indoor applications only.

Rod Lock Channel Nut

- Provides fast universal attachment of threaded rod and hardware to standard strut profiles
- Can be used to prefabricate assemblies which can be quickly pushed onto previously installed threaded rods
- Works with slightly damaged threads and minor burrs on the threaded rod

Simple solution for multi-tiered trapeze installations or wall mount strut applications. Designed for open-side-up or open-side-down strut configurations

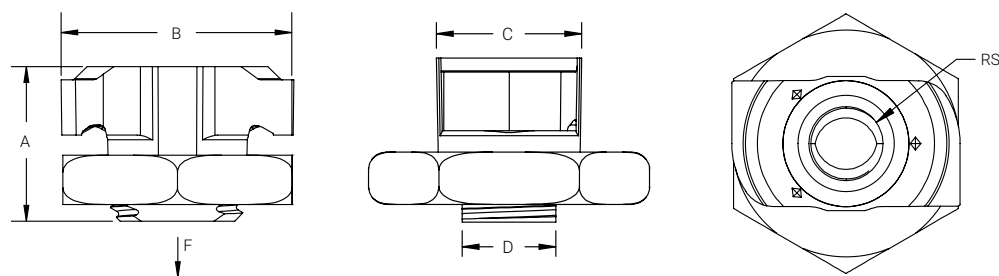

Material: Cast Iron
Finish: Electrogalvanized

| Part Number | Rod Size RS | A | B | C | D | Static Load F | Standard Packaging Quantity |
|-------------|-------------|-------|------|--------|-------|---------------|-----------------------------|
| CRLS37EG | 3/8" | 0.91" | 1.4" | 0.769" | 0.53" | 750 lb | 100 pc |
| CRLS37EGR2 | 3/8" | 0.91" | 1.4" | 0.769" | 0.53" | 750 lb | 20 x 2 pc |

For use on plain and electro zinc plated hardware only.

"[The] Rod Lock Channel Nut is inserted into the strut, and once on-site, we lift the racks in place with some expected labor savings. The entire project includes about 350 racks of pipe."

Will Vranich - Smith & Oby
(United States)

Rod Lock Strut Nut

- Allows for the quick creation, installation, and adjustment of multi-level trapeze assemblies
- Installs in strut profiles without the need to insert fingers or tools into the strut
- Easy "push-to-install" design allows installers to simply push the threaded rod through the mounting hole, instantly holding it in position
- Integrated adjustment nut enables fine tuning the system height up or down
- Lock nut can be finger tightened, locking the rod in place
- Accommodates slight variances in rod-to-rod position of the trapeze
- Can be used to prefabricate assemblies which can be quickly pushed onto previously installed threaded rods
- Works with slightly damaged threads and minor burrs on the threaded rod

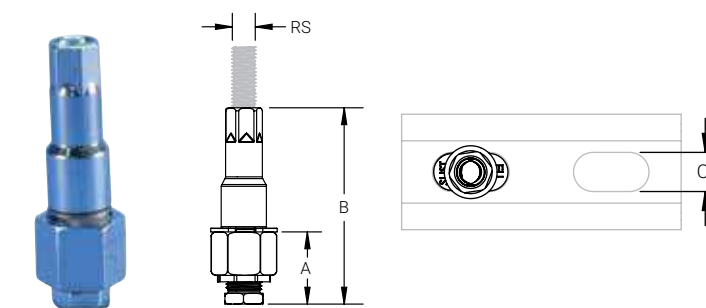

Material: Steel
Finish: Electrogalvanized

| Part Number | Strut Type | Rod Size RS | A | B | C | Wrench Size 2 | Wrench Size 2 |
|-------------|---------------------|-------------|-------|-------|-------|---------------|---------------|
| CRLSL37EG | A (1 5/8" x 1 5/8") | 3/8" | 1.19" | 3.23" | 9/16" | 15/16" | 14 mm |

Wrench Size 1 represents Rod Lock hex nut size. Wrench Size 2 represents stem nut size.

Must be installed with the open side of the strut channel facing up.

Rod Lock Strut Nuts must be installed at a minimum of 1" (25.4 mm) from both ends of the strut channel.

Rod Lock Nut

- Easy "push-to-install" design allows installers to simply push the threaded rod through the mounting hole, instantly holding it in position
- Fast installation onto long threaded rods – push the nut in place instead of threading it up the rod
- Excellent alignment and easy fine adjustment by spinning the nut
- Extremely useful in tight spaces where wrenches are difficult to use

An innovative nut that you push into place on threaded rod.

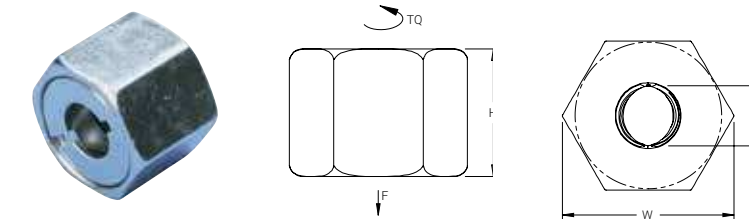

Material: Steel
Finish: Electrogalvanized

| Part Number | Rod Size RS | Height H | Width W | Wrench Size | Torque TQ | Static Load F |
|-------------|-------------|----------|---------|-------------|-----------|---------------|
| CRLN37EG | 3/8" | 0.8" | 1.1" | 15/16" | 5 ft lb | 1,350 lb |

Static Load based on Grade 2 threaded rod.

SN Series Nut

- Allows side mounting of nut to threaded rod
- Reduces the need for threading compared to standard nuts and washers
- Ideal for retrofit projects, such as trapeze installations, where disassembly of the support system is not desired
- Works with slightly damaged threads and minor burrs on the threaded rod
- Reduces installation time up to 50%

Innovative slotted design allows side mounting of the nut to threaded rod. Ideal for retrofit projects.

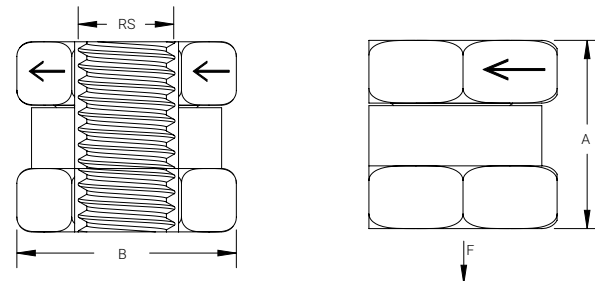

Material: Cast Iron
Finish: Electrogalvanized

| Part Number | Rod Size RS | A | B | Static Load F |
|-------------|-------------|-------|------|---------------|
| SN25 | 1/4" | 0.55" | 5/8" | 500 lb |
| SN37 | 3/8" | 0.75" | 3/4" | 1,350 lb |
| SN50 | 1/2" | 0.90" | 1" | 2,250 lb |

For use on plain and electro zinc plated hardware only.

"Using Rod Lock products on a large bus bar installation did not only significantly reduce our installation time, it also improved safety by making installation easier in hard to reach places."

Adam Stahl - Bravida Sverige AB (Sweden)

ALSO AVAILABLE:

STRUT TRAPEZE ATTACHMENT PLATE

- Creates fast install trapeze brackets
- Includes hex bolt and strut nut

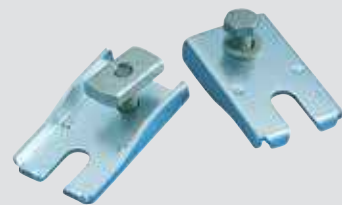

Material: Steel
Finish: Electrogalvanized

| Part Number | Rod Size RS |
|-------------|-------------|
| ISSP375 | 3/8" |

SNSW Flanged Nut

- Ideal for retrofit projects, such as trapeze installations, where disassembly of the support system is not desired
- Use as a stopper when installing Rod Lock assemblies
- Can be easily installed, removed, and repositioned at any location along the threaded rod
- Ready to use out of the box and eliminates multiple pieces of standard hardware
- Functions as a hex nut and flat washer combined
- Washer is wide enough to work with standard strut channel profiles

A combination of a slotted channel washer and nut that can be installed at any location along a threaded rod. Ideal for retrofit project where disassembly of the existing trapeze is not desired.

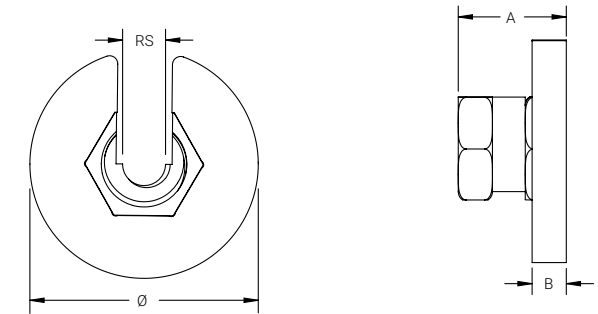
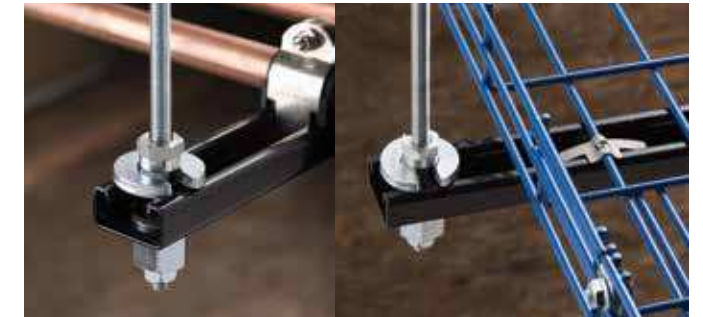

Material: Steel
Finish: Electrogalvanized
Static Load Safety Factor: 3:1

| Part Number | Rod Size RS | Diameter Ø | A | B | Wrench Size | Static Load F |
|-------------|-------------|------------|-------|------|-------------|---------------|
| SNSW37 | 3/8" | 1.67" | 0.79" | 1/4" | 3/4" | 300 lb |
| SNSW50 | 1/2" | 1.90" | 0.95" | 1/4" | 1" | 300 lb |

For use on plain and electro zinc plated hardware only.

ALSO AVAILABLE:

CUSHION CLAMP INSULATED STRUT CLAMP FOR PIPE/TUBE

- Fits into open side of strut channel
- Plastic cushion is hinged to spread apart for easy installation
- Reduces noise and absorbs shock by gripping the pipe/tube firmly
- Square neck of carriage bolt prevents over-tightening
- Nylon locknut prevents loosening under vibration

| | |
|---------------------|-------------------|
| Outer Diameter (OD) | 6.3 mm - 114.3 mm |
| Copper Tube Size | 1/4" - 4" |
| Pipe Size | 1/4" - 4" |
| NB/DN | 8 - 100 |

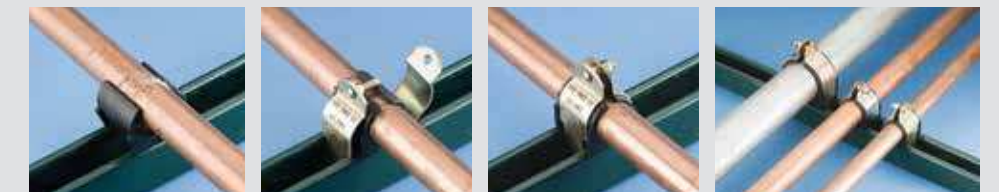

Rod Lock Wire Basket Support Clip

- Allows wire basket to be suspended from threaded rod without the need of a strut trapeze
- Easy "push-to-install" design allows installers to simply push the threaded rod through the mounting hole, instantly holding it in position
- Securing fingers provides superior stability, preventing damage to the cables in the basket
- Allows for pre-fabrication off site

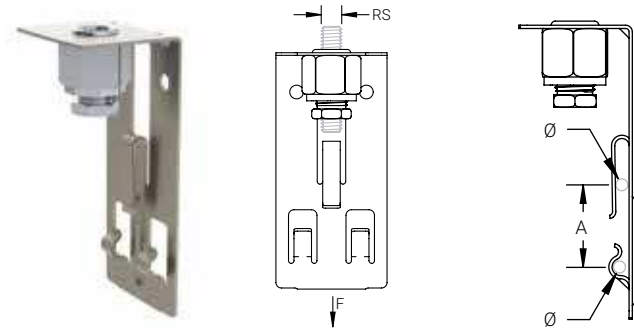

Material: Spring Steel; Steel
Finish: Armour; Electrogalvanized

| Part Number | Rod Size RS | Diameter Ø | A | Static Load F |
|-------------|-------------|---------------|-------------|---------------|
| WBS37RL | 3/8" | 0.14" – 0.24" | 1" – 1 1/4" | 120 lb |

Rod Lock Universal Tray Support

- Universal design to accommodate various cable tray hanging methods including ceiling, wall, threaded rod, or cable hanging systems
- C-shape maintains accessibility to cables after installation is completed
- Easy "push-to-install" design allows installers to simply push the threaded rod through the mounting hole, instantly holding it in position
- Strut profile on both arms allow for two runs of cable trays per bracket
- Top tab can be bent allowing for extra wide cable trays to be installed when two brackets are fastened back-to-back
- Key holes provided for wall mount applications
- Works with the KBT Wire Basket Tray Clip for securing wire basket cable tray or J-bolts for securing cable ladder

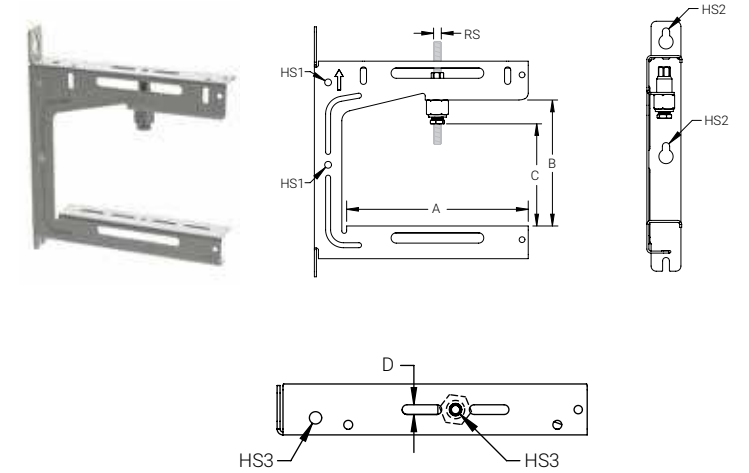

Material: Steel
Finish: Electrogalvanized

| Part Number | Rod Size RS | A | B | C | D | Hole Size 1 HS1 | Hole Size 2 HS2 | Hole Size 3 HS3 | Static Load 1 F1 | Static Load 1 F1 |
|-------------|-------------|-------|------|----|--------|-----------------|-----------------|-----------------|------------------|------------------|
| UTS15038RL | 3/8" | 6.5" | 6.1" | 5" | 0.325" | 0.33" | 0.33" | 0.41" | 100 lb | 200 lb |
| UTS20038RL | 3/8" | 8.8" | 6.1" | 5" | 0.325" | 0.33" | 0.35" | 0.41" | 100 lb | 200 lb |
| UTS30038RL | 3/8" | 12.7" | 6.2" | 5" | 0.325" | 0.33" | 0.33" | 0.41" | 100 lb | 200 lb |

Refer to Static Load 1 for installations with threaded rod.
Refer to Static Load 2 for wall mount and 3 mm nVent CADDY SPEED LINK installations.

ALSO AVAILABLE:

WIRE BASKET TRAY CLIP

- Attaches wire basket tray to strut without additional hardware
- No tools required

Material: Spring Steel
Finish: Armour

| Part Number | Wire Size | Standard Packing Quantity |
|-------------|---------------|---------------------------|
| KBT | 3/16" – 5/16" | 100 pc |

Use two clips per strut support for trays up to 12" (300mm). Use three clips per strut support for trays up to 18" (457mm) and add one clip per strut support for each additional 6" (150mm) of tray width.
No load rating, for positioning only.

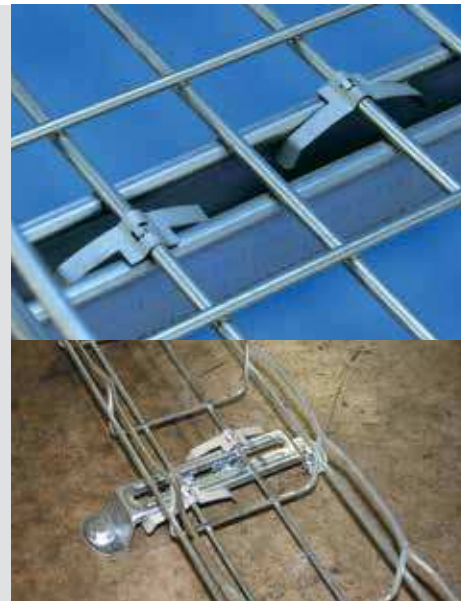

Our powerful portfolio of brands:

CADDY ERICO HOFFMAN RAYCHEM SCHROFF TRACER



[nVent.com/CADDY](https://www.nvent.com/CADDY)

ANSI is a registered trademark of American National Standards Institute, FM is a registered certification mark of FM Approvals LLC, LTD, ICC-ES is a registered trademark of ICC Evaluation Service, LLC, UL, UR, cUL, cUR, cULus and cURus are registered certification marks of UL LLC.

WARNING: nVent products shall be installed and used only as indicated in nVent product instruction sheets and training materials. Instruction sheets are available at [nVent.com/ERICO](https://www.nvent.com/ERICO) and from your nVent customer service representative. Improper installation, misuse, misapplication or other failure to completely follow nVent's instructions and warnings may cause product malfunction, property damage, serious bodily injury and death and/or void your warranty.

©2018 nVent. All nVent marks and logos are owned or licensed by nVent Services GmbH or its affiliates. All other trademarks are the property of their respective owners. nVent reserves the right to change specifications without notice.

CADDY-SB-FM1190B-FM110LT17NA-EN-1805