



Science.
Applied to Life.™

3M Industrial Products
Accessories for Abrasive Products

Accessories for Surface Modification











Table of Contents

Adapters, Mandrels, Cutters	2–3	Hand Pads, Blocks and Holders	39–45
3M™ Adapters	2	3M™ Center Water Feed Disc Hand Pads	39
3M™ Bristle Disc Adapters	3	3M™ Wetordry™ Bucket	39
3M™ Bristle Disc Mandrel	3	3M™ Rubber Sanding Blocks	39
3M™ SR Rotary Cutter	3	Pad Holders	40
Disc Pads and Holders	4–28	3M™ Hookit™ Hand Pads and Blocks	40–41
3M™ Disc Pad Face Plates	4–5	3M™ Dust Free Hand Pads and Blocks	42
3M™ Disc Pad Hubs	6	3M™ Fairing and Hand File Boards	42
3M™ Disc Retainer Nuts	7	Air File Shoes	43
3M™ Fibre Disc Backup Pads	7	3M™ Facing Material Roll	43
Disc Pad Holders (Hook-and-Loop)	8–9	3M™ Stikit™ Hand Pads and Blocks	44–45
3M™ Hookit™ Disc Pads	10–11	3M™ Screen Cloth Hand Pads	45
3M™ Hookit™ D/F Disc Pads	12	Mandrel and Spindles	46–48
3M™ Hookit™ Pads	13	3M™ Cartridge Roll Mandrels	46
3M™ Hookit™ Roloc™ Disc Pads	13	3M™ Forked Spindle	46
3M™ Roloc™ PSA Disc Pad	13	3M™ Mandrels	46
3M™ Hookit™ Clean Sanding Disc Pads and Pads	14–15	3M™ Roloc™ Mandrel TS/TSM	46
3M™ Hookit™ Clean Sanding Pad Hook Saver	15	3M™ Square/Cross Pad Mandrel	47
3M™ Hookit™ Interface Disc Pads	15	3M™ Star Mandrel	47
Scotch-Brite™ Hookit™ Conversion Face	15	3M™ Unitized Wheel Mandrels	47–48
3M™ Hookit™ Clean Sanding Interface Pads	16	3M™ Platen Pad Cover	48
3M™ Hookit™ Clean Sanding Disc Pad Hook Savers	16	3M™ Roto Peen Accessories	49
3M™ Random Orbital Sander 5" and 6" Backup Pads	17	Molding Adhesive and Stripe Removal	49
3M™ Stikit™ D/F Disc Pads (Vacuum)	18	3M™ Rubber Cushion Polishing Wheels	50
3M™ Stikit™ Disc Pads and Pads	19–20	3M™ Rubber Slotted Expander Wheels	51
3M™ Stikit™ D/F Pad	20	3M™ Wetordry™ Rubber Squeegees	52
3M™ Stikit™ Soft Interface Disc Pad	20	3M™ All Purpose Tack Cloth	52
3M™ Stikit™ Dispensers	20	UPC Index	53–55
3M™ PSA Disc Holders	21	Part No. Index	56
3M™ Roloc™ Shanks	22		
3M™ Roloc™ Disc Pads and Assemblies	23–26		
3M™ Roloc™ Cool Running Disc Pads	27		
3M™ Brake Hub Cleaning	28		
3M™ Roloc™+ Buttons and Holders	28		
3M™ Finesse-it™ Compounds, Polishes and Pads	29–36		
3M™ Finesse-it™ Compounds and Polishes	29–30		
3M™ Finesse-it™ Disc and Buffing Pads	31–33		
3M™ Perfect-it™ II Wool Compounding Pad	34		
3M™ Buffing and Polishing Accessories	34		
Scotch-Brite™ High Performance Cloth	35		
3M™ Finesse-it™ Hand Sanding Pads	35		
3M™ Finesse-it™ Roloc™ Backup Pads	35–36		
3M™ Hookit™ Polishing Pads	36		
3M™ Flanges	37		
3M™ RX Hub and Roto Peen Assembly	37		
3M™ Flap Disc Adapter Nut and Holder	38		
3M™ Flexible Grinding Wheel Backup Pads	38		

Adapters, Mandrels, Cutters

3M™ Adapters

Used to change the attachment style of a tool for use with common attachments used on accessories for abrasive disc products.

Product Name	UPC	Part No.	Description	Thread Size	MOQ	
3M™ Disc Holder Adapter 9		048011-22970-6	9	<ul style="list-style-type: none"> Convert a sander with a 3/8–24 external threaded shaft to a 5/8–11 EXT threaded shaft Use with 5/8–11 disc holders 	5/8–11 EXT x 3/8–24 INT	1
		048011-22971-3	9	<ul style="list-style-type: none"> Convert a sander with an M10–1.25 EXT threaded shaft to a 5/8–11 EXT threaded shaft Use with 5/8–11 disc holders 	5/8–11 EXT x M10–1.25 INT	1
		048011-22972-0	9	<ul style="list-style-type: none"> Convert a sander with an M10–1.5 EXT threaded shaft to a 5/8–11 EXT threaded shaft Use with 5/8–11 disc holders 	5/8–11 EXT x M10–1.50 INT	1
3M™ Wheel Adapter 81A		051144-45081-7	45081	<ul style="list-style-type: none"> Use with Type 81 and Type 84 PG Wheels 1/4" diameter shank and 1/4–20 INT thread to fit PG Wheels with 1/4–20 EXT threads 	1/4–20 INT	1
3M™ Wheel Adapter Kit		051141-28419-4	28419	Kit contains: <ul style="list-style-type: none"> one spindle extension 5/8–11 INT x 1/2–20 EXT three #5 telescoping adapters 5/8" wide one set #3 Flange Adapter 1" x 1/2" one set #3 Flange Adapter 1" x 5/8" two 2" OD x 1/2" ID Steel Washers two 2" OD x 5/8" ID Steel Washers one end cap 1" x 1/2–20 INT 	1/2–20 EXT x 5/8–11 INT	1
		051144-45038-1	45038	Kit contains: <ul style="list-style-type: none"> one spindle extension four 3/8" wide spacers two 3/16" wide spacers one 1" arbor hole adapter one cap nut one Allen Wrench 	5/8–11 EXT x 5/8–11 INT	1
		051141-27819-5	28719	<ul style="list-style-type: none"> Fits 3M™ Rubber Slotted Expander Wheel (PN28718) Kit contains: <ul style="list-style-type: none"> one adapter 1" x 5/8–11 INT one end cap 1" x 5/8–11 INT one spacer 1" dia. x 5/8" CH x 3/16" wide one 5/8–11 x 1-1/2" LG SHCS one 1/2" Allen Wrench 	5/8–11 INT	1
3M™ Spindle Extender Kit		048011-04019-6	300	<ul style="list-style-type: none"> Use on flexible shafts with Scotch-Brite™ Wheels 6" or 8" diameter and up to 4" wide for better alignment and handling Spindle has 5/8–11 INT thread and 5/8–11 EXT thread Kit contains: <ul style="list-style-type: none"> two 3/8" wire spacers two 1" x 5/8" flange adapters one 2" OD x 5/8" ID washer one spanner nut one spindle extension 	5/8–11 EXT x 5/8–11 INT	1
Replacement Spacers		051141-28636-5	28636	1" OD x 5/8" ID x 3/8" thick	—	1
		051141-28637-2	28637	1" OD x 5/8" ID x 3/16" thick	—	1

Adapters, Mandrels, Cutters

3M™ Bristle Disc Adapters

Product Name	UPC	Part No.	Description	Size	MOQ
3M™ Flange Adapter	048011-27628-1	27628	<ul style="list-style-type: none"> 6" Flange Adapter Flange minimum capacity of 7 discs (1/2" wide) used with 6" Radial Bristle Discs to optimize mount on bench motors with a shaft size of 1" diameter A #5 Flange Adapter can be used on shaft sizes down to 1/2" diameter 	2" Dia x 1" ID	25
3M™ Tapered Spindle Mount Adapter	048011-30133-4	30133	<ul style="list-style-type: none"> Tapered Spindle Mount Adapter Adapter configured for convenient disc mount of 2" to 3" fine bristle discs Fits on standard tapered spindle for bench motors 	3/8-24 EXT	50
3M™ Spindle Extender Adapter	048011-30134-1	30134	<ul style="list-style-type: none"> 6" Spindle Extender Adapter 	2" x 1/2" x 1"	40

3M™ Bristle Disc Mandrel

Used with Bristle Discs to change the center hole to fit machine shaft size.

Product Name	UPC	Part No.	Description	Length	Shank Size	MOQ
3M™ Bristle Disc Mandrel	048011-27680-9	27680	<ul style="list-style-type: none"> Use with small radial bristle discs 1" diameter or smaller with 1/16" center hole Fits 3/32" drill or collet chucks Max RPM 30,000 	1-3/4"	1/16"	5

3M™ SR Rotary Cutter

Use these plastic rotary cutters on a right angle power tool with its integral metal mandrel at slow speeds to remove sealant and adhesives. Removes coatings without damaging the underlying base material like paints, primers, alodine and metal.

Product Name	UPC	Part No.	Diameter	Length	Thread Size	Max RPM	MOQ
3M™ SR Cutter No. 3	048011-30096-2	3	.40"	.975"	1/4-28 EXT	3,200	40
3M™ SR Cutter No. 8	048011-30095-5	8	.83"	1.015"	1/4-28 EXT	3,200	40

Disc Pads and Holders

3M™ Disc Pad Face Plates

3M™ Disc Pad Face Plates can be easily changed without removing the hub. Allows the operator to use a single tool for multiple applications from grinding to finishing a work piece.

Available in the following densities to meet various applications:

Color	Description	Applications
Red	Extra Hard	Heavy grinding
Black	Hard	Heavy metal removal, large welds, etc
Gray	Medium	General purpose grinding and finishing — normal flexibility
White	Soft	Finishing operations — flexible, follows contours

Power Tool Assembly

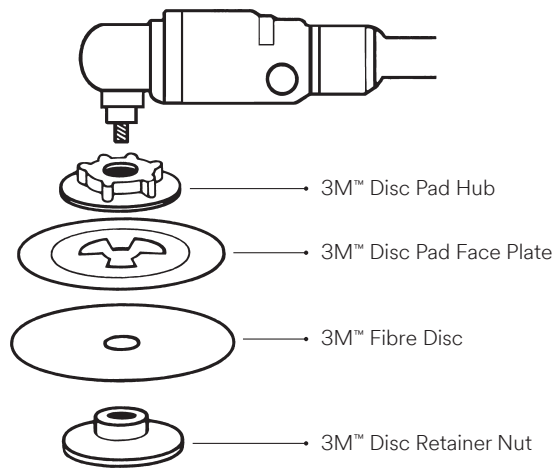

3M™ Disc Pad Face Plates













For use with fibre discs. Available in various hardnesses for use with various size discs and fibre disc pad hubs.

Product Name	UPC	Part No.	Description	Diameter	Color	Hardness	Max RPM	MOQ	
3M™ Disc Pad Face Plate, Smooth		051144-13325-3	13325	Smooth	4-1/2"	Gray	Medium	13,300	1
		051144-14270-5	14270	Smooth	4-1/2"	Black	Hard	13,300	1
		051144-45208-8	45208	Smooth	5"	White	Soft	12,000	10
		051144-45194-4	45194	Smooth	7"	White	Soft	8,600	10

Disc Pads and Holders

3M™ Disc Pad Face Plates (cont.)











For use with fibre discs. Available in various hardnesses for use with various size discs and fibre disc pad hubs.

Product Name	UPC	Part No.	Description	Diameter	Color	Hardness	Max RPM	MOQ	
3M™ Disc Pad Face Plate, Ribbed		051141-28656-3	28656	Ribbed	4"	Red	Extra Hard	15,000	10
		051141-28657-0	28657	Ribbed	4"	Black	Hard	15,000	10
		051141-28658-7	28658	Ribbed	4"	Gray	Medium	15,000	10
		051141-28443-9	28443	Ribbed	4-1/2"	Red	Extra Hard	13,300	1
		051144-81734-4	81734	Ribbed	5"	Gray	Medium	12,000	1
		051144-81733-7	81733	Ribbed	5"	Black	Hard	12,000	1
		051144-81732-0	81732	Ribbed	5"	Red	Extra Hard	12,000	1
		051141-28625-9	81732L	Ribbed	5"	Red	Extra Hard	12,000	10
		051144-80516-7	80516	Ribbed	7"	Gray	Medium	8,600	1
		051144-80515-0	80515	Ribbed	7"	Black	Hard	8,600	1
		051144-80514-3	80514	Ribbed	7"	Red	Extra Hard	8,600	1
		051144-81729-0	81729	Ribbed	9"	Black	Hard	6,600	10
	051144-81728-3	81728	Ribbed	9"	Red	Extra Hard	6,600	10	

Disc Pads and Holders

3M™ Disc Pad Hubs





Disc pad hubs have a threaded metal insert and can be used on most face plates.

Product Name	UPC	Part No.	Description	Diameter	Thread Size	Color	MOQ	
3M™ Disc Pad Hub		051144-11824-3	11824	<ul style="list-style-type: none"> • GL Quick Change • Use with 4" to 7" face plates • Adapters available for M10–1.25, M10–1.50, 3/8–24 shafts* 	2-1/2"	5/8–11 INT	Black	1
		051144-45205-7	45205	<ul style="list-style-type: none"> • Can be used on all 4" to 9" face plates 	2-1/2"	5/8–11 INT	Black	1
		051141-28626-6	45205L	<ul style="list-style-type: none"> • Can be used on all 4" to 9" face plates 	2-1/2"	5/8–11 INT	Black	20
		051144-88743-9	88743	<ul style="list-style-type: none"> • For right angle grinders with 5/8–11 EXT short shafts (3/8"–1/2" long) • Can be used on 4" to 9" face plates 	2-1/2"	5/8–11 EXT x 5/8–11 INT	Black	1
		051141-28442-2	28442	<ul style="list-style-type: none"> • Low Profile design allows fibre disc to fit inside tool guards • For right angle grinders with 3/8–24 EXT shaft • Can be used on all 4" to 9" face plates • 5/8–11 EXT thread for 3M retainer nuts or TN Fibre discs 	2-1/2"	3/8–24 INT x 5/8–11 EXT	Black	1
		051141-28476-7	28476	<ul style="list-style-type: none"> • Low Profile design allows fibre disc to fit inside tool guards • Can be used on 4" to 9" face plates 	2-1/2"	5/8–11 INT	Black	10
		051144-11823-6	11823	<ul style="list-style-type: none"> • GL Quick Change • Hub is used with color-coded extra hard, hard, medium, and soft backup plates • Use with 7" face plates • Adapters available for M10–1.25, M10–1.50, 3/8–24 shafts 	4-1/2"	5/8–11 INT	Black	1
		051144-45190-6	45190	<ul style="list-style-type: none"> • Can be used on 7", 8" and 9" face plates 	4-1/2"	5/8–11 INT	Black	1
		051111-60306-2	86100	<ul style="list-style-type: none"> • Can be used on 7" and larger face plates 	4-1/2"	5/8–11 INT	Black	10
3M™ Disc Pad Hub and Retainer Nut		051141-28416-3	28416	<ul style="list-style-type: none"> • Disc pad hub and retainer nut kit • For use on grinders with M14–2 threaded spindle • Can be used on 4-1/2" through 9" Fiber Discs with 7/8" (22mm) center hole 	2-1/2"	M14–2.0 INT	Black	1
		051141-28417-0	28417	<ul style="list-style-type: none"> • Disc pad hub and retainer nut kit • For use on grinders with M14–2 threaded spindle • Can be used on 4-1/2" through 9" Fiber Discs with 7/8" (22mm) center hole 	4-1/2"	M14–2.0 INT	Black	1



Disc Pads and Holders

3M™ Disc Retainer Nuts

For use with 3M™ Disc Pad Hub and Face Plates and 3M™ Fibre Disc Holders. 1/4" diameter holes for use with a spanner wrench.



Product Name	UPC	Part No.	Length	Thread Size	MOQ	
3M™ Disc Retainer Nut		051111-51047-6	02618	5/16"	5/8-11 INT	10
		051141-28654-9	28654	5/16"	M14-2.0 INT	10
		051144-05620-0	05620	5/8"	5/8-11 INT	1
		051144-05622-4	05622	3/8"	5/8-11 INT	1
		051144-05621-7	05621	1/2"	5/8-11 INT	1

3M™ Fibre Disc Backup Pads

Product Name	UPC	Part No.	Description	Size	MOQ	
3M™ Fibre Disc Backup Pad		051131-05637-4	05637	<ul style="list-style-type: none"> For use with Fibre Discs on pistol grip sanders Uses retainer nut sold separately 18,000 Max RPM 	5" x 7/8" CH	1
3M™ TN Quick Change Fibre Disc Backup Pad		051111-56573-5	02140	<ul style="list-style-type: none"> TN platform allows quick change of 3M products as needed without using tools or retainer nuts Use with TN discs 13,300 Max RPM 	4-1/2" x 5/8-11 INT	5



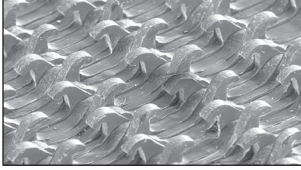
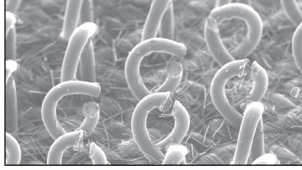
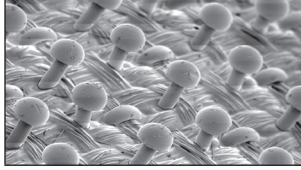
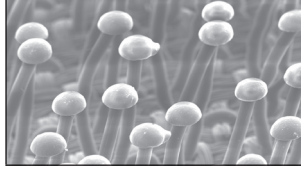
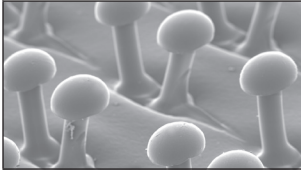
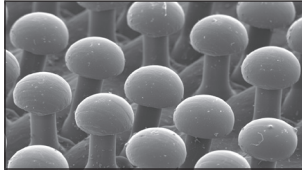

Disc Pads and Holders

3M™ Disc Pad Hook Types

Hook Type 1: 3M™ Hookit™ Small Molded J Hook 	Hook Type 2: 3M™ Hookit™ Tall J Hook 	Hook Type 3: 3M™ Hookit™ Mushroom Hook 	Hook Type 4: Hook-and-Loop Tall Mushroom Hook (250HD) 
Hook Type 5: 3M™ Dual Lock™ Hook Type 170 	Hook Type 6: 3M™ Dual Lock™ Hook Type 400 	Hook Type 7: Hook-and-Loop Tall T Hook 	

Disc Pad Holders (Hook-and-Loop)

Use with hook-and-loop discs. Allows discs to be run on right angle grinders or random orbital sanders.

Product Name	Image	UPC	Part No.	Size	Thick-ness	Ctr. Hole	Thread/Shank Size	Density Rating	Hook Type	Max RPM (OPM)	MOQ
3M™ Disc Pad Holder		048011-04130-8	9215	1-1/2"	1/8"	—	1/4"	Firm	5	25,000	10
		048011-07494-8	922	2"	1/8"	—	1/4"	Firm	5	23,000	1
		048011-04132-2	923	3"	1/8"	—	1/4"	Firm	5	20,000	1
Scotch-Brite™ Surface Conditioning Disc Pad Holder 7493		051131-07493-4	7493	3"	1/8"	—	1/4"	Firm	5	20,000	10
Scotch-Brite™ Surface Conditioning Disc Pad 924		048011-07492-4	924	4"	1/16"	—	1/4"	Firm	5	13,000	5
3M™ Disc Pad Holder		048011-05673-9	914	4"	1/8"	3/8"	1/2–13 INT	Firm	7	13,000	1
		048011-05674-6	914	4"	1/8"	3/8"	5/8–11 INT	Firm	7	13,000	1
		048011-05677-7	914	4"	1/8"	3/8"	M14–2.0 INT	Firm	7	13,000	1

Disc Pads and Holders

Disc Pad Holders (Hook-and-Loop) (cont.)

Use with hook-and-loop discs. Allows discs to be run on right angle grinders or random orbital sanders.

Product Name	UPC	Part No.	Size	Thick-ness	Ctr. Hole	Thread/Shank Size	Density Rating	Hook Type	Max RPM (OPM)	MOQ	
3M™ Disc Pad Holder		048011-14111-4	9145	4-1/2"	1/8"	3/8"	5/8-11 INT	Firm	7	13,000	1
		048011-14114-5	9145	4-1/2"	1/8"	3/8"	M14-2.0 INT	Firm	7	13,000	1
		048011-09448-9	905	5"	1/4"	—	5/16-24 EXT	Medium	7	10,000 (12,000)	1
		048011-05680-7	915	5"	1/8"	3/8"	5/8-11 INT	Firm	7	10,000	1
		048011-05681-4	915	5"	1/8"	3/8"	M14-2.0 INT	Firm	7	10,000	1
		048011-09449-6	906	6"	1/4"	—	5/16-24 EXT	Medium	7	8,500 (10,000)	1
		048011-05682-1	916	6"	1/8"	3/8"	5/8-11 INT	Firm	7	10,000	1
		048011-09450-2	917	7"	5/16"	3/8"	5/8-11 INT	Medium	7	6,000	1
3M™ Hook-and-Loop Disc Pad Holders		051141-28852-9	20245	7"	—	7/8"	5/8-11 INT	Extra Hard	7	8,500	1
	NEW! 	051141-28888-8	28888	7"	—	7/8"	5/8-11 INT	Medium	7	8,600	1
	NEW! 	051141-28890-1	28890	5"	—	7/8"	5/8-11 INT	Medium	7	12,000	1
	NEW! 	051141-28891-8	28891	4-1/2"	—	7/8"	5/8-11 INT	Medium	7	12,000	1
	NEW! 	051141-28892-5	28892	4"	5/8"	5/8"	5/8-11 INT	Firm	7	15,000	1
3M™ Disc Pad Holder		051141-20279-2	20279	7"	1"	—	5/8-11 INT	Medium	7	6,000	1
3M™ Hook-and-Loop Disc Face Plate		051141-20439-0	20439	7"	—	—	—	Extra Hard	7	8,600	10
3M™ Disc Pad Holder		048011-09451-9	918	8"	5/16"	3/8"	5/8-11 INT	Medium	7	6,000	1

Disc Pads and Holders

3M™ Disc Pads Shape Profile

- 1 One piece stud design for improved balance and reduced vibration
- 2 Color-coded pads with customized features make it simpler to achieve the exact finish desired
- 3 Upgraded hole placement for clean sanding pads for the ultimate in dust extraction

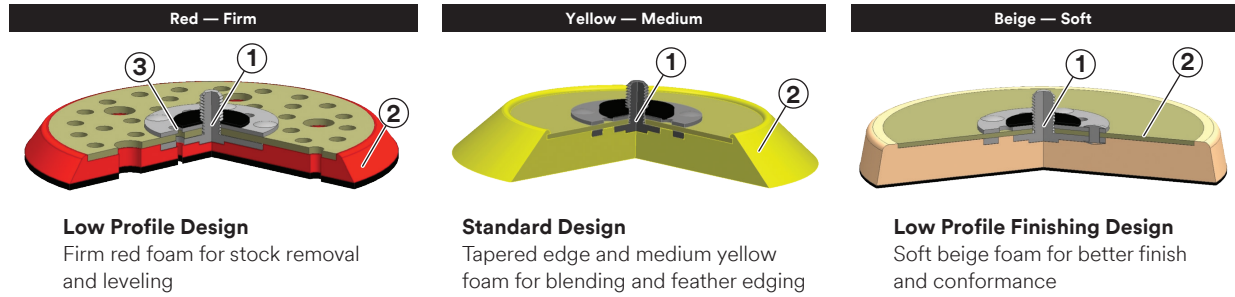

3M™ Hookit™ Disc Pads







These disc pads have a hook attachment which drives 3M™ Hookit™ Discs with brushed nylon loop backings.

Product Name	UPC	Part No.	Diameter	Thickness	Thread Size	Density Rating	Hook Type	Max RPM (OPM)	MOQ	
3M™ Hookit™ Disc Pad		051111-55764-8	02700	3"	1/2"	5/16-24 EXT	Firm	2	15,000 (15,000)	5
		051141-28472-9	28472	3"	1/2"	1/4-20 EXT	Firm	2	15,000 (15,000)	5
		051144-88739-2	88739	3"	11/16"	5/8-11 INT	Medium	1	6,000	5
		051131-05775-3	05775	5"	3/4"	5/16-24 EXT	Medium	1	12,000 (12,000)	1
		051144-85105-8	85105	5"	3/4"	5/8-11 INT	Medium	1	12,000	1
		051144-85096-9	85096	5"	5/8"	5/8-11 INT	Medium	1	12,000	1
		051141-28662-4	28662	5"	1/2"	5/8-11 INT	Medium	1	12,000	1

Disc Pads and Holders

3M™ Hookit™ Disc Pads (cont.)









These disc pads have a hook attachment which drives 3M™ Hookit™ Discs with brushed Nylon loop backings.

Product Name	UPC	Part No.	Diameter	Thickness	Thread Size	Density Rating	Hook Type	Max RPM (OPM)	MOQ	
3M™ Hookit™ Disc Pad		048011-18444-9	18444	5"	3/4"	M8-1.25 INT	Medium	1	10,000 (12,000)	5
		051141-28709-6	70138	6"	3/4"	5/16-24 EXT	Medium	2	12,000 (12,000)	1
		051144-13627-8	947	7"	1"	5/8-11 INT	Medium	1	6,000	1
		051131-07394-4	07394	7" (178mm)	1" (25mm)	M14-2.0 INT	Medium	1	6,000	1
		051144-77751-8	77751	8"	5/16"	5/8-11 INT	Firm	1	6,000	1
		051141-28548-1	77751B	8"	5/16"	5/8-11 INT	Medium	1	6,000	50
		051131-05779-1	05779	8"	1"	5/8-11 INT	Medium	1	3,000	1
		051131-05768-5	05768	8"	1"	5/8-11 INT	Soft	1	3,000	1
3M™ Hookit™ Low Profile Disc Pad		051141-20352-2	20352	5"	3/8"	5/16-24 EXT	Firm	2	12,000 (12,000)	1
		051141-20355-3	20355	6"	3/8"	5/16-24 EXT	Firm	2	12,000 (12,000)	1
3M™ Hookit™ Low Profile Finishing Disc Pad		051144-77855-3	77855	5"	11/16"	5/16-24 EXT	Soft	1	12,000 (12,000)	1
3M™ Hookit™ Low Profile Disc Pad for 7447 PRO Discs		051141-28852-9	28852	5"	3/8"	5/16-24 EXT	Firm	2	12,000 (12,000)	1

Disc Pads and Holders

3M™ Hookit™ D/F Disc Pads

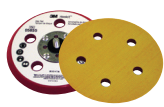
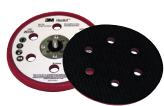
For use with 3M™ Hookit™ D/F Discs. Available in various densities and thicknesses for your vacuum sanding needs.

Product Name	UPC	Part No.	Size	Thick-ness	Thread Size	# of Dust Holes	Density Rating	Hook Type	Max RPM (OPM)	MOQ	
3M™ Hookit™ D/F Disc Pad		051144-82659-9	82659	5"	3/4"	5/16-24 EXT	5	Medium	1	12,000 (12,000)	1
		051141-28411-8	28411	5" (for 6" ROS)	3/4"	5/16-24 EXT	5	Medium	1	12,000 (12,000)	1
		051131-05876-7	05876	6" x 3/4" CH	3/4"	5/16-24 EXT	6	Medium	1	12,000 (12,000)	1
		051131-07390-6	07390	6" x 3/4" CH	3/4"	M8-1.25 EXT	6	Medium	1	12,000 (12,000)	1
		051131-05781-4	05781	8"	3/8"	5 Bolt Holes	8	Medium	1	1,500 (10,000)	1
		051131-05782-1	05782	8"	3/8"	6 Bolt Holes	8	Medium	1	1,500 (10,000)	1
		051131-05783-8	05783	8"	3/8"	5 Bolt Holes	8	Firm	1	1,500	1
	3M™ Hookit™ D/F Low Profile Backup Pad		051131-05855-2	05855	5"	3/8"	5/16-24 EXT	5	Firm	1	12,000 (12,000)
3M™ Hookit™ D/F Low Profile Disc Pad		051141-25122-6	25122	6"	3/8"	5/16-24 EXT	6	Firm	2	12,000 (12,000)	1
3M™ Hookit™ D/F Low Profile Finishing Disc Pad		051144-77856-0	77856	5"	11/16"	5/16-24 EXT	5	Soft	1	12,000 (12,000)	1
		051111-51042-1	84226	5"	11/16"	5/16-24 EXT	5	Soft	1	12,000 (12,000)	1

Disc Pads and Holders







3M™ Hookit™ Pad

Pad provides excellent adhesion with the brushed Nylon loop backing. Hook attachment firmly secures the 3M™ Hookit™ Sheet and allows easy sheet removal. Use with 3M™ Hookit™ Abrasive Sheets.

Product Name	UPC	Part No.	Size	Thickness	Color	Face Color	Density Rating	Hook Type	Max OPM	MOQ	
3M™ Hookit™ Pad		051141-20433-8	20433	3" x 4"	1/2"	Red	Black	Medium	1	10,000	10

3M™ Hookit™ Roloc™ Disc Pads

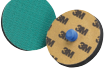
Hook material attached to soft neoprene foam which provides a resilient base when using QRS Flexible Diamond discs. These disc pads allows for easy micron grade change. Pad must be used with proper Roloc™ Disc Pad hardware.

Product Name	UPC	Part No.	Attachment	Diameter	Thickness	Density Rating	Hook Type	Max RPM (OPM)	MOQ	
3M™ Hookit™ Roloc™ Disc Pad		051144-82564-6	82564	Roloc™ TR	1"	5/16"	Medium	2	8,000 (10,000)	10
		051111-60311-6	67415	Roloc™ TR	1-1/16"	5/16"	Medium	1	10,000 (10,000)	20
		051141-28655-6	28655	Roloc™ TR	1-1/4"	5/16"	Medium	1	10,000 (10,000)	20
		051144-82565-3	82565	Roloc™ TR	1-1/2"	5/16"	Medium	2	8,000 (10,000)	5
		051144-82566-0	82566	Roloc™ TR	2"	5/16"	Medium	2	8,000 (10,000)	5
		051144-82567-7	82567	Roloc™ TR	3"	5/16"	Medium	2	8,000 (10,000)	1

3M™ Roloc™ PSA Disc Pad

Skin surface of neoprene foam provides a resilient base when using PSA Flexible Diamond discs.

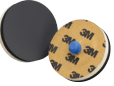
Product Name	UPC	Part No.	Diameter	Attachment	Density Rating	Max OPM	Max RPM	MOQ	
3M™ Roloc™ PSA Disc Pad		051144-85287-1	85287	2"	Roloc™ TR	Medium	10,000	10,000	5

Disc Pads and Holders

Disc Pads and Holders

3M™ Hookit™ Clean Sanding Disc Pads

Designed with high performance hole patterns. Pair with a 3M™ Random Orbital Sander to increase abrasive life and achieve high efficiency dust pickup.



Product Name	UPC	Part No.	Size	Thick-ness	Thread Size	# of Holes	Density Rating	Hook Type	Max RPM (OPM)	MOQ
3M™ Clean Sanding Disc Pad Kit*	051141-20427-7	20427	3"	1/2"	5/16-24 INT	6	Medium	1	15,000 (15,000)	5
3M™ Clean Sanding Soft Disc Pad	051141-20428-4	20428	3"	3/4"	1/4-20 EXT	6	Soft	1	12,000 (12,000)	10
3M™ Hookit™ Clean Sanding Low Profile Disc Pad	051141-20350-8	20350	3"	1/2"	1/4-20 EXT	3	Firm	2	15,000 (15,000)	10
3M™ Clean Sand Painter's Pad with Hookit™	051131-05858-3	05858	5" x 3/4" CH	1/2"	5/16-24 EXT	31	Soft	1	12,000 (12,000)	10
3M™ Clean Sanding Backup Pad	051141-20206-8	20206	5" x 3/4" CH	1/2"	5/16-24 EXT	31	Medium	1	12,000 (12,000)	10
3M™ Clean Sanding Low Profile Finishing Disc Pad	051141-20290-7	20290	5"	11/16"	5/16-24 EXT	44	Soft	1	12,000 (12,000)	10
3M™ Hookit™ Clean Sanding Low Profile Disc Pad	051141-20353-9	20353	5"	3/8"	5/16-24 EXT	44	Firm	2	12,000 (12,000)	10
3M™ Clean Sanding Low Profile Disc Pad 861 Plus	051141-20465-9	20465	6" x 5/8" CH	3/8"	5/16-24 EXT	49	Firm	2	12,000 (12,000)	10
3M™ Clean Sanding Soft Disc Pad	051141-20425-3	20425	6" x 3/4" CH	1/2"	5/16-24 EXT	53	Soft	1	10,000 (12,000)	10
3M™ Hookit™ Clean Sand Painter's Backup Pad	051131-05551-3	05551	6" x 3/4" CH	1/2"	5/16-24 EXT	25	Soft	1	12,000 (12,000)	10
3M™ Hookit™ Clean Sanding Low Profile Disc Pad	051141-20356-0	20356	6"	3/8"	5/16-24 EXT	52	Firm	2	12,000 (12,000)	10
3M™ Clean Sanding Dust Free Disc Pad with Hookit™	051131-05865-1	05865	6" x 3/4" CH	1/2"	5/16-24 EXT	25	Firm	1	12,000 (12,000)	10

*Kit includes 5 adapters: 1/4-20 EXT x 5/16-24 EXT; 1/4-20 INT x 5/16-24 EXT; 1/4-28 EXT x 5/16-24 EXT; 5/16-24 EXT x 5/16-24 EXT; 5/16-24 EXT x 6mm-1.0 EXT

Disc Pads and Holders

3M™ Hookit™ Clean Sanding Pads

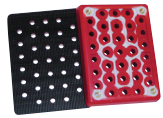
3M™ Clean Sanding Holders and Abrasives with a multi-hole design pattern to achieve high efficiency dust pickup. Use the 3M™ Vacuum Sander, Clean Sanding Holders and Clean Sanding Sheets for a total system solution.

Product Name	UPC	Part No.	Size	Thickness	# of Holes	Color	Face Color	Density Rating	Hook Type	Max OPM	MOQ	
3M™ Hookit™ Clean Sanding Pad		051141-20435-2	20435	3" x 4"	1/2"	33	Red	Black	Medium	1	10,000	10
		051141-28531-3	28531	70mm x 198mm	12.7mm	56	Red	Black	Medium	1	10,000	5

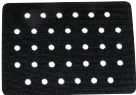

3M™ Hookit™ Clean Sanding Pad Hook Saver

Protects the hooks on a new 3M™ Hookit™ Clean Sanding Pad. An inexpensive attachment device to be consumed during sanding in place of a more expensive pad. Use with 3M™ Hookit™ Clean Sanding Pad (PN20435).

Product Name	UPC	Part No.	Size	# of Holes	Face Color	Hook Type	Max OPM	MOQ	
3M™ Clean Sanding Pad Hook Saver		051141-28325-8	28325	3" x 4"	33	Black	2	12,000	20







3M™ Hookit™ Interface Disc Pads

Constructed of durable foam to be used with standard 3M™ Hookit™ Backup Pad which increases conformability allowing the technician to get in closer to most edges.

Product Name	UPC	Part No.	Diameter	Thickness	Density Rating	Hook Type	Max RPM (OPM)	MOQ	
3M™ Hookit™ Interface Disc Pad		051111-56491-2	70166	5"	1/2"	Soft	1	12,000 (12,000)	10
	NEW! 	051141-28845-1	28845	3" x 4"	1/2"	Medium	3	— (12,000)	10
	NEW! 	051125-87276-8	87276	70mm x 198mm	1/2"	Soft	2	— (12,000)	10

Scotch-Brite™ Hookit™ Conversion Face

Use to convert 3M™ Hookit™ II holders to a Hook-and-Loop holder for driving Surface Conditioning Products.

Product Name	UPC	Part No.	Use With	Diameter	Hook Type	MOQ	
Scotch-Brite™ Hookit™ Conversion Face	NEW! 	051141-28801-7	28801	7447 PRO and 7448 PRO Discs	5"	4	5
	NEW! 	051141-28802-4	28802	7447 PRO and 7448 PRO Discs	6"	4	5
	NEW! 	051141-28803-1	28803	7447 PRO and 7448 PRO Discs	8"	4	5
	NEW! 	051141-28804-8	28804	7447 PRO and 7448 PRO Sheets	3 x 4"	4	5
	NEW! 	051141-28805-5	28805	7447 PRO and 7448 PRO Sheets	2.75 x 7.75"	4	5
	NEW! 	051141-28806-2	28806	7447 PRO and 7448 PRO Discs	3"	4	5

Disc Pads and Holders

3M™ Hookit™ Clean Sanding Interface Pads

Use with 3M™ Clean Sanding Discs. Constructed of soft durable foam. When used with a Clean Sanding Multi-hole Hookit™ Backup Pad it increases conformability allowing you to follow contours and get closer to most edges while maximizing dust extraction.

Product Name	UPC	Part No.	Size	Thick-ness	Ctr Hole	# of Dust Holes	Density Rating	Hook Type	Max RPM (OPM)	MOQ
3M™ Clean Sanding Interface Pad	051141-28324-1	28324	3" x 4"	1/2"	—	33	Medium	3	— (12,000)	10
3M™ Clean Sanding Interface Disc Pad	051141-28323-4	28323	5" Dia.	1/2"	3/4"	31	Medium	3	12,000 (12,000)	10
3M™ Hookit™ Soft Interface Pad	051131-05771-5	05771	3" Dia.	1/2"	—	6	Soft	3	15,000 (15,000)	10
3M™ Clean Sanding Soft Interface Disc Pad	051141-20278-5	20278	5" Dia.	1/2"	3/4"	31	Soft	3	12,000 (12,000)	10
	051141-28321-0	28321	5" Dia.	1/2"	—	44	Soft	2	12,000 (12,000)	10
	051141-28322-7	28322	6" Dia.	1/2"	—	52	Soft	2	12,000 (12,000)	10
	NEW! 051125-87277-5	87277	70mm x 198mm	1/2"	—	56	Soft	2	— (12,000)	10
3M™ Hookit™ Soft Interface Pad	051131-05777-7	05777	6" Dia.	1/2"	3/4"	25	Soft	3	12,000 (12,000)	10

3M™ Hookit™ Clean Sanding Disc Pad Hook Savers









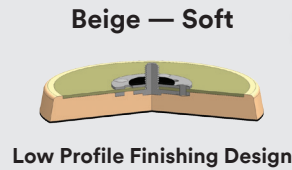
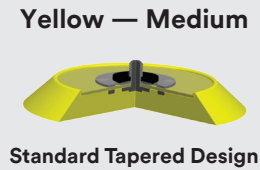
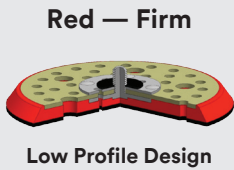















Protects the hooks on a new 3M™ Hookit™ Clean Sanding Disc Pad. An inexpensive attachment to be consumed during sanding in place of a more expensive disc pad.

Product Name	UPC	Part No.	Use With	Diameter	Ctr Hole	# of Dust Holes	Hook Type	Max RPM (OPM)	MOQ
3M™ Clean Sanding Disc Pad Hook Saver	051141-28326-5	28326	PN20350	3"	—	3	2	15,000 (15,000)	20
	051141-20444-4	20444	PN20353	5"	—	44	2	12,000 (12,000)	20
	051141-20443-7	20443	PN20206	5"	3/4"	31	2	12,000 (12,000)	20
	051141-20446-8	20446	PN20356	6"	—	52	2	12,000 (12,000)	20
	051141-20445-1	20445	PN05865	6"	3/4"	25	2	12,000 (12,000)	20

3M™ Random Orbital Sander 5" and 6" Backup Pads

One Piece Stud Design, Color Coded and Simplified







	Attachment	# Holes	PN	UPC	Dia.	Thickness	Thread	Foam	Face	Pads/Cs.
Low Profile	 3M™ Stikit™	—	20351	051141-20351-5	5"	3/8"	5/16–24 EXT	Red	Blue	10
	 3M™ Stikit™	—	20354	051141-20354-6	6"	3/8"	5/16–24 EXT	Red	Blue	10
	 3M™ Stikit™	—	85104	051144-85104-1	5"	3/8"	5/16–24 EXT	Red	Silver	10
	 3M™ Stikit™	5 Holes	20442	051141-20442-0	5"	3/8"	5/16–24 EXT	Red	Blue	10
	 3M™ Stikit™	6 Holes	20454	051141-20454-3	6"	3/8"	5/16–24 EXT	Red	Blue	10
	 3M™ Hookit™	—	20352	051141-20352-2	5"	3/8"	5/16–24 EXT	Red	Black	10
	 3M™ Hookit™	—	20355	051141-20355-3	6"	3/8"	5/16–24 EXT	Red	Black	10
	 3M™ Hookit™	5 Holes	05855	051131-05855-2	5"	3/8"	5/16–24 EXT	Red	Yellow	10
	 3M™ Hookit™	6 Holes	25122	051141-25122-6	6"	3/8"	5/16–24 EXT	Red	Black	10
	 3M™ Hookit™	44 Holes	20353	051141-20353-9	5"	3/8"	5/16–24 EXT	Red	Black	10
 3M™ Hookit™	52 Holes	20356	051141-20356-0	6"	3/8"	5/16–24 EXT	Red	Black	10	
 3M™ Hookit™	861 Plus, 53 Holes	20465	051141-20465-9	6"	3/8"	5/16–24 EXT	Red	Black	10	
Standard	 3M™ Stikit™	—	05575	051144-05575-3	5"	3/4"	5/16–24 EXT	Yellow	Blue	10
	 3M™ Stikit™	—	45215	051144-45215-6	5"	3/4"	5/16–24 EXT	Yellow	Silver	10
	 3M™ Stikit™	—	81821	051144-81821-1	5"	3/4"	5/16–24 EXT	Yellow	Red	10
	 3M™ Stikit™	—	28772	051141-28772-0	6"	3/4"	5/16–24 EXT	Yellow	Blue	10
	 3M™ Stikit™	5 Holes	45217	051144-45217-0	5"	3/4"	5/16–24 EXT	Yellow	Blue	10
	 3M™ Stikit™	6 Holes	45218	051144-45218-7	6"	3/4"	5/16–24 EXT	Yellow	Blue	10
	 3M™ Hookit™	—	05775	051131-05775-3	5"	3/4"	5/16–24 EXT	Yellow	Yellow	10
	 3M™ Hookit™	—	70138	051141-28709-6	6"	3/4"	5/16–24 EXT	Yellow	Yellow	10
	 3M™ Hookit™	5 Holes	82659	051144-82659-9	5"	3/4"	5/16–24 EXT	Yellow	Yellow	10
	 3M™ Hookit™	6 Holes	05876	051131-05876-7	6"	3/4"	5/16–24 EXT	Yellow	Yellow	10
Low Profile Finishing	 3M™ Stikit™	—	05545	051131-05545-2	5"	11/16"	5/16–24 EXT	Beige	Brown	10
	 3M™ Stikit™	—	05546	051131-05546-9	6"	11/16"	5/16–24 EXT	Beige	Brown	10
	 3M™ Stikit™	5 Holes	05645	051131-05645-9	5"	11/16"	5/16–24 EXT	Beige	Blue	10
	 3M™ Stikit™	6 Holes	05646	051131-05646-6	6"	11/16"	5/16–24 EXT	Beige	Brown	10
	 3M™ Hookit™	—	77855	051144-77855-3	5"	11/16"	5/16–24 EXT	Beige	Yellow	10
	 3M™ Hookit™	5 Holes	77856	051144-77856-0	5"	11/16"	5/16–24 EXT	Beige	Yellow	10
	 3M™ Hookit™	5 Holes + Groove	84226	051111-51042-1	5"	11/16"	5/16–24 EXT	Beige	Black	10
	 3M™ Hookit™	44 Holes	20290	051141-20290-7	5"	11/16"	5/16–24 EXT	Yellow	Yellow	10
	 3M™ Hookit™	53 Holes	20425	051141-20425-3	6"	11/16"	5/16–24 EXT	Beige	Yellow	10

Disc Pads and Holders





Disc Pads and Holders

3M™ Stikit™ Disc Pads Face Color

Color	Description	Applications
 Silver	Slightly lower than standard adhesion, easiest removal characteristics	High heat (woodworking)
 Blue	Standard level of adhesion, standard removal characteristics	General purpose
 Black	Standard level of adhesion, standard removal characteristics	General purpose
 Red	Higher level of adhesion	High speed

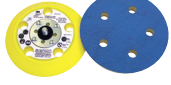
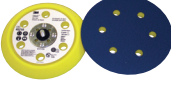
3M™ Stikit™ D/F Disc Pads (Vacuum)

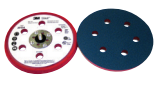
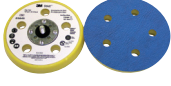
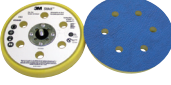

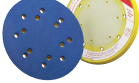













These disc pads have a vinyl face material which drives 3M™ Stikit™ D/F Discs (Vacuum) with Pressure Sensitive adhesive backings. Dust collection holes align with hole patterns in the abrasive discs.

Product Name	UPC	Part No.	Diameter	Thick-ness	Thread Size	# of Dust Holes	Density Rating	Max RPM (OPM)	MOQ	
3M™ Stikit™ D/F Disc Pad		051144-45217-0	45217	5"	3/4"	5/16-24 EXT	5	Medium	10,000 (12,000)	10
		051144-45218-7	45218	6"	3/4"	5/16-24 EXT	6	Medium	10,000 (12,000)	10
3M™ Stikit™ D/F Low Profile Disc Pad		051141-20442-0	20442	5"	3/8"	5/16-24 EXT	5	Firm	12,000 (12,000)	10
		051141-20454-3	20454	6"	3/8"	5/16-24 EXT	6	Firm	12,000 (12,000)	10
3M™ Stikit™ D/F Low Profile Finishing Disc Pad		051131-05645-9	05645	5"	11/16"	5/16-24 EXT	5	Soft	12,000 (12,000)	10
		051131-05646-6	05646	6"	11/16"	5/16-24 EXT	6	Soft	10,000 (12,000)	10
3M™ Stikit™ D/F Disc Pad		051131-05581-0	05581	8"	3/8"	5 Bolt Holes	8	Medium	1,500 (10,000)	10
		051131-05582-7	05582	8"	3/8"	6 Bolt Holes	8	Medium	1,500 (10,000)	10

Disc Pads and Holders

3M™ Stikit™ Disc Pads

These disc pads have a vinyl face material which drives 3M™ Stikit™ Discs with Pressure Sensitive Adhesive backings.

Product Name	UPC	Part No.	Diameter	Thickness	Thread Size	Density Rating	Max RPM (OPM)	MOQ	
3M™ Stikit™ Disc Pad		051111-56472-1	70449	1-1/8"	1/8"	—	Soft	10,000 (12,000)	5
		051111-55813-3	70234	5"	1/2"	5/8-11 INT	Medium	12,000	1
		051141-28661-7	28661	5"	1/2"	5/8-11 INT	Medium	12,000	1
		051144-05575-3	05575	5"	3/4"	5/16-24 EXT	Medium	10,000 (12,000)	1
		051144-45215-6	45215	5"	3/4"	5/16-24 EXT	Medium	10,000 (12,000)	1
		051144-81821-1	81821	5"	3/4"	5/16-24 EXT	Medium	10,000 (12,000)	1
		051144-82178-5	82178	5"	1-1/4"	5/16-24 EXT	Soft	7,500 (12,000)	1
		051141-28772-0	28772	6"	3/4"	5/16-24 EXT	Medium	10,000 (12,000)	1
		051144-05579-1	05579	8"	1"	5/8-11 INT	Medium	3,000	1
		051131-05568-1	05568	8"	1"	5/8-11 INT	Soft	3,000	1
3M™ Stikit™ Low Profile Disc Pad		051141-20348-5	20348	3"	1/2"	1/4-20 EXT	Firm	15,000 (15,000)	10
		051144-85104-1	85104	5"	3/8"	5/16-24 EXT	Firm	10,000 (12,000)	1
		051141-20351-5	20351	5"	3/8"	5/16-24 EXT	Firm	12,000 (12,000)	1
		051141-28817-8	28817	5"	3/8"	5/16-24 EXT	Extra Firm	12,000 (12,000)	1
		051141-20354-6	20354	6"	3/8"	5/16-24 EXT	Firm	12,000 (12,000)	1
3M™ Stikit™ Low Profile Finishing Disc Pad		051131-05545-2	05545	5"	11/16"	5/16-24 EXT	Soft	12,000 (12,000)	1
		051131-05546-9	05546	6"	11/16"	5/16-24 EXT	Soft	10,000 (12,000)	1

Disc Pads and Holders

3M™ Stikit™ Pads

Lightweight, shock-resistant pads have a tough vinyl face that provides excellent adhesion yet allows quick, easy sheet removal. Well-balanced pads made with a rugged, durable, plastic hub and foam body. For use with 3" x 4" 3M™ Stikit™ Sheets or 3" wide 3M™ Stikit™ Sheet Rolls with adhesive contained on the backing.

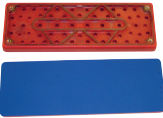
Product Name	UPC	Part No.	Size	Thickness	Color	Face Color	Density Rating	Max OPM	MOQ	
3M™ Stikit™ Pad		051141-20432-1	20432	3" x 4"	1/2"	Red	Blue	Medium	10,000	10
		051141-28660-0	28660	2-3/4" x 7-3/4"	1/2"	Red	Blue	Medium	10,000	5

3M™ Stikit™ D/F Pad

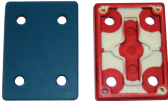
Product Name	UPC	Part No.	Size	Thickness	Color	Face Color	Density Rating	Max OPM	MOQ	
3M™ Stikit™ D/F Pad		051141-20434-5	20434	3" x 4"	1/2"	Red	Blue	Medium	10,000	10



3M™ Stikit™ Soft Interface Disc Pad

Soft foam with loop material bonded on both sides. One side attaches to a 3M™ Hookit™ Backup Pad and the other side attaches to a 3M™ Stikit™ Disc.

Product Name	UPC	Part No.	Diameter	Thickness	Foam Color	Face Color	Density Rating	Max OPM	Max RPM	MOQ	
3M™ Stikit™ Soft Interface Disc Pad		051111-56459-2	02795	5"	1/2"	Gray	White	Soft	12,000	12,000	25

3M™ Stikit™ Dispensers









Sturdy metal dispensers for quick and easy dispensing and storage of 3M™ Stikit™ Disc and Sheet Rolls. Keeps abrasives flat while protecting the adhesive backing.

Product Name	UPC	Part No.	Description	MOQ	
3M™ Stikit™ Disc Roll Dispenser		051144-05450-3	05450	<ul style="list-style-type: none"> For dispensing 5" or 6" 3M™ Stikit™ Disc Rolls Portable or can be wall or bench mounted Holds two rolls 	1
3M™ Stikit™ Double Roll Dispenser		051144-05452-7	05452	<ul style="list-style-type: none"> For dispensing 2-3/4" 3M™ Stikit™ Sheet Rolls Portable Holds two rolls 	1

Disc Pads and Holders

3M™ PSA Disc Holders

PSA Disc Holders can be used with sanders that have a 1/4" collet chuck. Provides excellent support when grinding hard-to-reach areas. Holder face diameter is smaller than disc size to allow for easier disc centering and removal.

Product Name	UPC	Part No.	Diameter	Shank	Color	Face Color	Density Rating	Max RPM	MOQ	
3M™ PSA Disc Holder		051144-45074-9	45074	1/2"	1/4"	Black	Black	Medium	20,000	1
		051144-45073-2	45073	3/4"	1/4"	Black	Black	Medium	20,000	1
		051144-45072-5	45072	1"	1/4"	Black	Black	Medium	20,000	1
		051144-45071-8	45071	1-1/2"	1/4"	Black	Black	Medium	20,000	1
		051144-45070-1	45070	2"	1/4"	Black	Black	Medium	15,000	1
		051144-05510-4	05510	3"	1/4"	Black	Black	Medium	10,000	10
		051144-45069-5	45069	4"	1/4"	Black	Black	Medium	7,500	1
		051144-45068-8	45068	5"	1/4"	Black	Black	Medium	6,000	1

Disc Pads and Holders

3M™ Roloc™ Attachment Systems

Rubber disc pads are available in different diameters and types of hardness for various grinding applications.



3M™ Roloc™ TR Disc Pad

- Easily mounts directly to tools with a 1/4 -20 EXT thread shaft or use with a 3M™ Roloc™ Shank to fit collet chuck tools
- Other specific thread sizes available



3M™ Roloc™ TP Disc Pad

- Disc pad for use with 3M™ Roloc™ TP Discs or with other “press on” type abrasive discs
- Easily mounts directly to tools with a 1/4-20 EXT thread shaft or use with a 3M™ Roloc™ Shank to fit collet chuck tools

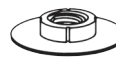

3M™ Roloc™ TS or TSM Disc Pad

- Disc pad for use with 3M™ Roloc™ TSM discs or with other “screw on” type Standard Abrasive™ abrasive discs
- Easily mounts directly to tools with a 1/4-20 EXT thread shaft or use with a 3M™ Roloc™ Shank to fit collet chuck tools

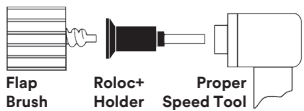

3M™ Roloc™ + Holders

- Use with 3M™ Roloc™ + products and other Scotch-Brite™ bench area Roloc™ + products or with right angle disc sanders or straight shaft die grinders

Important Information:

Use 3M™ Roloc™ TR Discs with 3M™ Roloc™ Disc Pads for safe, secure performance. Non-3M disc pads may have a deeper threaded cavity which causes the button to continue to tighten down during use. This can cause the button to separate from the disc resulting in the disc flying off and potential operator harm.





3M™ Roloc™ Disc Pad



Non-3M Disc Pad





3M™ Roloc™ Shanks

These shanks allow 3M™ Roloc™ TR Disc Pads to fit collet chucks or drill chucks. The 1/4-20 external thread fits 3M™ Roloc™ Disc Pads with 1/4-20 internal threads.

Product Name	UPC	Part No.	Shank Size	Thread Size	MOQ	
3M™ Roloc™ Shank		051144-82455-7	82455	6mm	1/4-20 EXT	5
		051144-45102-9	45102	1/4"	1/4-20 EXT	5







Disc Pads and Holders

3M™ Roloc™ Disc Pad TR Assemblies

Product Name	UPC	Part No.	Includes	Diameter	Thread Size	Color	Density Rating	Max RPM	MOQ
3M™ Roloc™ Disc Pad TR Assembly		051131-05538-4	05538	3M™ Roloc™ Shank and Adapter	1"	1/4-20 INT	Black Hard	30,000	1
		051144-05539-5	05539	3M™ Roloc™ Shank and Adapter	2"	1/4-20 INT	Black Hard	25,000	1
3M™ Roloc™ Gasket Removal Disc Pad Assembly		051131-07715-7	07715	3M™ Roloc™ Gasket Removal Disc Pad Holder	2"	1/4-20 INT	Black Hard	25,000	1
3M™ Roloc™ Disc Pad TR Assembly		051144-05540-1	05540	3M™ Roloc™ Shank and Adapter	3"	1/4-20 INT	Black Hard	20,000	1
		051131-05541-4	05541	3M™ Roloc™ Shank and Adapter	4"	1/4-20 INT	Black Medium	12,000	1

3M™ Roloc™ Disc Pads TR















Rubber backup pad supports 3M™ Roloc™ Discs in different degrees of hardness for varying grinding applications. Conveniently mounts directly to tools with threaded shafts or used with 3M™ Roloc™ Shank to fit collet chuck tools.

Product Name	UPC	Part No.	Diameter	Thread Size	Color	Density Rating	Max RPM	MOQ	
3M™ Roloc™ Disc Pad TR		051144-45101-2	45101	1"	1/4-20 INT	Black	Medium	30,000	5
		051144-45100-5	45100	1-1/2"	1/4-20 INT	Black	Hard	30,000	5
		051144-45099-2	45099	1-1/2"	1/4-20 INT	Black	Medium	30,000	5
		051144-45098-5	45098	1-1/2"	1/4-20 INT	Black	Soft	30,000	5
		051144-45097-8	45097	2"	1/4-20 INT	Black	Extra Hard	25,000	5
		051144-45096-1	45096	2"	1/4-20 INT	Black	Hard	25,000	5
		051144-45095-4	45095	2"	1/4-20 INT	Black	Medium	25,000	5

Disc Pads and Holders

3M™ Roloc™ Disc Pads TR (cont.)

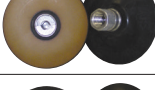



Rubber backup pad supports 3M™ Roloc™ Discs in different degrees of hardness for varying grinding applications. Conveniently mounts directly to tools with threaded shafts or used with 3M™ Roloc™ Shank to fit collet chuck tools.

Product Name	UPC	Part No.	Diameter	Thread Size	Color	Density Rating	Max RPM	MOQ	
3M™ Roloc™ Disc Pad TR		051144-45094-7	45094	2"	1/4-20 INT	Black	Soft	20,000	5
		051144-45093-0	45093	3"	1/4-20 INT	Black	Extra Hard	20,000	5
		051144-45091-6	45091	3"	1/4-20 INT	Black	Hard	20,000	5
		051144-88748-4	88748	3"	3/8-24 INT	Black	Hard	20,000	5
		051144-45092-3	45092	3"	1/4-20 INT	Black	Medium	18,000	5
		051144-45090-9	45090	3"	1/4-20 INT	Black	Soft	15,000	5
		051111-55765-5	82879	3"	5/8-11 INT	Black	Soft	15,000	5
		051144-84993-2	84993	75mm	M14-2.0 INT	Black	Extra Hard	20,000	5
		051144-84998-7	84998	75mm	M14-2.0 INT	Black	Hard	20,000	5
		051144-85000-6	85000	75mm	M10-1.5 INT	Black	Hard	20,000	5
		051144-84999-4	84999	75mm	M14-2.0 INT	Black	Medium	18,000	5
		051144-45179-1	45179	4"	1/4-20 INT	Black	Medium	12,000	5
		051144-83980-3	83980	4"	5/8-11 INT	Black	Extra Hard	12,000	5
		051144-83242-2	83242	4"	5/8-11 INT	Black	Medium	12,000	5
		051144-83489-1	83489	4"	5/8-11 INT	Black	Hard	12,000	5

Disc Pads and Holders

3M™ Roloc™ Disc Pads TR (cont.)

Rubber backup pad supports 3M™ Roloc™ Discs in different degrees of hardness for varying grinding applications. Conveniently mounts directly to tools with threaded shafts or used with 3M™ Roloc™ Shank to fit collet chuck tools.

Product Name	UPC	Part No.	Diameter	Thread Size	Color	Density Rating	Max RPM	MOQ	
3M™ Roloc™ Disc Pad TR		051141-28714-0	28714	4"	5/8-11 INT	Black	Extra Hard	12,000	5
		051141-28713-3	28713	4"	5/8-11 INT	Black	Hard	12,000	5
		051141-28712-6	28712	4"	5/8-11 INT	Black	Medium	12,000	5
		051141-28474-3	28474	4"	3/8-24 INT	Black	Hard	12,000	5
		051141-28475-0	28475	4"	3/8-24 INT	Black	Extra Hard	12,000	5

3M™ Roloc™ Disc Pads TP











Backup pad designed to support 3M™ Roloc™ Discs. Pads have a 1/4-20 INT thread which allows it to be mounted directly to tools with 1/4-20 EXT threaded shafts or use with 3M™ Roloc™ Shank to fit collet chuck tools.

Product Name	UPC	Part No.	Diameter	Thread Size	Color	Density Rating	Max RPM	MOQ	
3M™ Roloc™ Disc Pad TP		051144-77723-5	77723	1"	1/4-20 INT	Black	Medium	30,000	5
		051144-77726-6	77726	1-1/2"	1/4-20 INT	Black	Medium	30,000	5
		051144-14197-5	14197	2"	1/4-20 INT	Black	Medium	25,000	5
		051144-14198-2	14198	2"	1/4-20 INT	Black	Hard	25,000	5
		051144-14202-6	14202	3"	1/4-20 INT	Black	Hard	20,000	5
		051144-14201-9	14201	3"	1/4-20 INT	Black	Medium	18,000	5

Disc Pads and Holders

3M™ Roloc™ Disc Pads TS/TSM

Backup pad designed to support 3M™ Roloc™ Discs. Pad has a 1/4–20 INT thread which allows it to be mounted directly to tools with 1/4–20 EXT threaded shafts or use with 3M™ Roloc™ Shank to fit collet chuck tools.

Product Name	UPC	Part No.	Diameter	Thread Size	Color	Density Rating	Max RPM	MOQ	
3M™ Roloc™ Disc Pad TS/TSM		051144-77724-2	77724	1"	1/4–20 INT	Black	Medium	30,000	5
		051144-77728-0	77728	1-1/2"	1/4–20 INT	Black	Hard	30,000	5
		051144-77729-7	77729	1-1/2"	1/4–20 INT	Black	Medium	30,000	5
		051144-14211-8	14211	2"	1/4–20 INT	Black	Medium	25,000	5
		051144-14212-5	14212	2"	1/4–20 INT	Black	Hard	25,000	5
		051144-14215-6	14215	3"	1/4–20 INT	Black	Medium	18,000	5
		051144-14216-3	14216	3"	1/4–20 INT	Black	Hard	20,000	5
		051144-77737-2	77737	3"	1/4–20 INT	Black	Extra Hard	18,000	5
		051144-77740-2	77740	4"	1/4–20 INT	Black	Medium	12,000	5
		051141-28742-3	28742	4"	M10–1.5 INT	Black	Extra Hard	12,000	5

Disc Pads and Holders

3M™ Roloc™ Cool Running Disc Pads

For use with tools with vacuum shrouds. (Dust shrouds ordered as KUT accessory item). Use with threaded shank or adapter supplied with vacuum shroud kits. Holes and channels in the pad allow air to flow through the pad which reduces the heat concentration.

Product Name	UPC	Part No.	Diameter	Thread Size	# of Holes	Color	Face Color	Density Rating	Max RPM	MOQ	
3M™ Roloc™ D/F Disc Pad		051144-82974-3	82974	2"	1/4-20 INT	6	Black	Black	Medium	20,000	5
		051144-82975-0	82975	3"	1/4-20 INT	6	Black	Black	Medium	12,000	5
		051111-56479-0	02286	4"	3/8-24 INT	8	Black	Black	Hard	15,000	5
3M™ Roloc™ D/F Cool Running Disc Pad TR		051141-28473-6	28473	4"	5/8-11 INT	8	Black	Black	Hard	15,000	5
3M™ Roloc™ Cool Running Disc Pad TS/TSM		051141-28710-2	28710	3"	1/4-20 INT	6	Black	Black	Hard	12,000	5
		051141-28711-9	28711	2"	1/4-20 INT	6	Black	Black	Hard	20,000	5
3M™ Roloc™ D/F Cool Running Disc Pad TS/TSM	NEW! 	051141-28889-5	28889	4"	M14-2.0 INT	8	Black	Black	Hard	15,000	5

Disc Pads and Holders

3M™ Brake Hub Cleaning

Product Name	UPC	Part No.	Diameter	Shank Size	Color	Max RPM	MOQ
3M™ Brake Hub Cleaning Disc Holder	051131-07545-0	07545	—	1/4"	Black	20,000	6
Scotch-Brite™ Roloc™ Brake Hub Cleaning Disc Kit	051131-07547-4	07547	1-1/2"	1/4"	Purple	20,000	5

3M™ Roloc™+ Buttons and Holders











Designed with extended shank which provides added bending strength for applications which require side loads.

Product Name	UPC	Part No.	Diameter	Thread Size	Shank Size	Color	Max RPM	MOQ
3M™ Roloc™+ Button	048011-15060-4	7	3/8"	Roloc™+	—	Red	25,000	5
3M™ Roloc™+ Button Combination Pack	048011-14915-8	1 and 7	1"	Roloc™+	1/4"	Black/ Red	25,000	5
3M™ Roloc™+ Holder	051131-07500-9	07500	1"	Roloc™+	1/4"	Black	25,000	1
	048011-15408-4	1	1"	Roloc™+	1/4"	Black	25,000	5
	048011-33734-0	2	1-1/2"	Roloc™+	1/4"	Black	25,000	5
	048011-33732-6	3	2"	Roloc™+	1/4"	Black	25,000	5
	048011-33733-3	4	3"	Roloc™+	1/4"	Black	20,000	5

3M™ Finesse-it™ Compounds, Polishes and Pads

3M™ Finesse-it™ Compounds and Polishes (cont.)



Specially designed compounds and polishes to be used on OEM and baked refinish paints to remove sand scratches or to remove swirl marks from previously compounded areas.

Product Name		UPC	Part No.	Description	Size	Color	MOQ
3M™ Finesse-it™ Polish		051111-61104-3	61104	Purple	50 Gallon	Purple	1
		051141-20272-3	20272	Non-pigmented Purple Polish	55 Gallon	White	4
		051141-28696-9	28696	Ultra Fine	Liter	White	12
3M™ Glass Polishing Compound		051111-61009-1	60150	Glass Polishing Compound	Liter	White	6
3M™ Finesse-it™ Polish		051141-28792-8	28792	Finishing Material	8 oz	White	4
		051141-28793-5	28793	K211	8 oz	White	4
		051141-28794-2	28794	Extra Fine	8 oz	White	4
		051141-28795-9	28795	Purple	8 oz	Purple	4
		051141-28796-6	28796	Final Finish Gray	8 oz	Gray	4
		051141-28797-3	28797	Ultra Fine	8 oz	White	4

3M™ Finesse-it™ Compounds, Polishes and Pads











3M™ Finesse-it™ Disc Pads

Disc pads used to drive 3M™ Finesse-it™ Discs.

Product Name	UPC	Part No.	Desc.	Diameter	Thick-ness	Color	Face Color	Density Rating	Hook Type	Max OPM	Max RPM	MOQ
3M™ Finesse-it™ PSA Hard Pad		051141-20207-5	3125H PSA	1-1/4"	1/8"	Black	Blue	Hard	—	7,500	7,500	10
3M™ Finesse-it™ PSA Soft Pad		051111-60537-0	3125P PSA	1-1/4"	1/8"	Black	Blue	Soft	—	10,000	7,500	20
3M™ Finesse-it™ Hookit™ Disc Pad		051144-14738-0	14738 Hookit	5" x 5/8-11 INT	1"	Orange	Yellow	Soft	1	—	7,000	5

3M™ Finesse-it™ Buffing Pads













3M™ Finesse-it™ Buffing Pads provide a soft, smooth surface for applying 3M™ Finesse-it™ Polishes. 3M™ Hookit™ Attachment System.

Product Name	UPC	Part No.	Desc.	Diameter	Color	Max OPM	Max RPM	MOQ
3M™ Finesse-it™ Buffing Pad		134375-38287-8	09357 Felt	3"	Red/White	12,000	12,000	50
		134375-38286-1	09358 Felt	5"	Red/White	12,000	12,000	50
		051141-20274-7	20274 Foam	1-1/2"	Orange	12,000	12,000	20
		051111-60799-2	01963 Foam	3"	White Foam/Black Loop	12,000	12,000	10
		051111-51151-0	02648 Foam	3-1/4"	Orange Foam/White Loop	12,000	12,000	10
		051111-60527-1	02648B Foam	3-1/4"	Orange Foam/Black Loop	12,000	12,000	10
		051141-20271-6	20271 Open Cell Foam	3-3/4"	White Foam/White Loop	12,000	12,000	10
		051111-51158-9	02637 Foam	3-3/4"	Orange Foam/White Loop	12,000	12,000	50
		051135-92500-3	01912 Foam	5-1/4"	White Foam/Black Loop	12,000	12,000	10
		051111-51076-6	02362 Foam	5-1/4"	Orange Foam/White Loop	12,000	12,000	10
		051111-60528-8	02362B Foam	5-1/4"	Orange Foam/Black Loop	12,000	12,000	10

3M™ Finesse-it™ Compounds, Polishes and Pads

3M™ Finesse-it™ Buffing Pads (cont.)













3M™ Finesse-it™ Buffing Pads provide a soft, smooth surface for applying 3M™ Finesse-it™ Polishes. 3M™ Hookit™ Attachment System.

Product Name	UPC	Part No.	Desc.	Diameter	Color	Max OPM	Max RPM	MOQ	
3M™ Finesse-it™ Buffing Pad	NEW! 	051141-28878-9	28878	Foam, Waffle Face	3-1/4"	Gray	12,000	12,000	50
	NEW! 	051141-28879-6	28879	Foam, Waffle Face	3-3/4"	Gray	12,000	12,000	50
	NEW! 	051141-28880-2	28880	Foam, Waffle Face	5-1/4"	Gray	12,000	12,000	50
	NEW! 	051141-28873-4	28873	Foam, Flat Face	3-1/2"	Gray	12,000	12,000	50
	NEW! 	051125-87391-8	87391	Foam, Flat Face	5-1/4"	Gray	12,000	12,000	50
	NEW! 	051141-28869-7	28869	Foam, Waffle Face	3-1/4"	Green	12,000	12,000	50
	NEW! 	051141-28870-3	28870	Foam, Waffle Face	3-3/4"	Green	12,000	12,000	50
	NEW! 	051141-28871-0	28871	Foam, Waffle Face	5-1/4"	Green	12,000	12,000	50
	NEW! 	051141-28872-7	28872	Foam, Flat Face	3-1/2"	Green	12,000	12,000	50
	NEW! 	051141-28874-1	28874	Foam, Waffle Face	3-1/4"	Red	12,000	12,000	50
	NEW! 	051141-28875-8	28875	Foam, Waffle Face	3-3/4"	Red	12,000	12,000	50
	NEW! 	051141-28876-5	28876	Foam, Waffle Face	5-1/4"	Red	12,000	12,000	50
	NEW! 	051141-28877-2	28877	Foam, Flat Face	3-1/2"	Red	12,000	12,000	50

3M™ Finesse-it™ Compounds, Polishes and Pads

3M™ Finesse-it™ Buffing Pads (cont.)

3M™ Finesse-it™ Buffing Pads provide a soft, smooth surface for applying 3M™ Finesse-it™ Polishes. 3M™ Hookit™ Attachment System.

Product Name	UPC	Part No.	Desc.	Diameter	Pile Height	Color	MOQ
3M™ Finesse-it™ Knit Buffing Pad	 051144-85078-5	85078	Knit	3"	15/16"	White	10
	 051144-85079-2	85079	Knit	5-1/4"	15/16"	White	10
3M™ Finesse-it™ Knit II Buffing Pad	 051144-85084-6	85084	Knit II	3"	15/16"	White	10
	 051144-85099-0	85099	Knit II	3"	11/16"	White	10
	 051144-85083-9	85083	Knit II	5-1/4"	15/16"	White	10
3M™ Finesse-it™ Low Lint Knit II Buffing Pad	NEW!  051141-28863-5	28863	Knit II	3"	1/2"	White	10
	NEW!  051141-28862-8	28862	Knit II	5-1/4"	1/2"	White	10
	NEW!  051141-28864-2	28864	Knit II	7"	1/2"	White	10
3M™ Finesse-it™ Natural Buffing Pad	 051111-50193-1	5730	Natural	3"	1/4"	White	10
	 051144-81470-1	81470	Natural	3"	20mm	White	10
	 051144-85103-4	85103	Natural	3"	20mm	Black	10
	 051144-81471-8	81471	Natural	5-1/4"	20mm	White	10
	 051144-85100-3	85100	Natural	5-1/4"	20mm	Black	10
	 051144-82531-8	82531	Natural	7"	20mm	White	10











3M™ Finesse-it™ Compounds, Polishes and Pads

3M™ Perfect-it™ II Wool Compounding Pad

Made of fine wool fibers stitched into a polyester backing with a 11/16" trim length. Pad is pre-washed to reduce lint. Designed with a 3M™ Hookit™ Attachment System for use with 3M™ Finesse-it™ Polishes.

Product Name	UPC	Part No.	Diameter	Color	MOQ
3M™ Perfect-it™ II Wool Compounding Pad 	051111-51043-8	01927	5-1/4"	White	2

3M™ Buffing and Polishing Accessories

Product Name	UPC	Part No.	Size	Thread Size	Density Rating	Max RPM (OPM)	MOQ
3M™ Buff Pad Adaptor 	051144-05710-8	05710	1" Hex.	5/8-11	—	—	10
3M™ Hookit™ Backup Pad 	051131-05717-3	05717	7"	5/8-11	Soft	3,000	1
3M™ Perfect-It™ Backup Pad 	051131-05718-0	05718	7"	5/8-11	Soft	3,000	1
3M™ Foam Compounding Pad 	051131-05723-4	05723	8"	—	—	2,000 (2,000)	1
3M™ Perfect-It™ Foam Buffing Pad 	051131-05759-3	05759	3"	—	—	11,000	6
3M™ Perfect-It™ Ultrafine Foam Polishing Pad 	051131-05760-9	05760	3"	—	—	11,000	6
3M™ Perfect-It™ DA Glazing Pad 	051131-05729-6	05729	6-3/4"	—	—	2,000	12
3M™ Foam Polishing Pad 	051131-05725-8	05725	8"	—	—	2,000 (2,000)	1
3M™ Ultrafine Foam Polishing Pad 	051131-05751-7	05751	8"	—	—	2,000 (2,000)	1
3M™ Detailing Squeeze Bottle 	051131-37720-2	37720	12 fl oz	—	—	—	24
3M™ Detailing Spray Bottle 	051131-37716-5	37716	32 fl oz	—	—	—	24

3M™ Finesse-it™ Compounds, Polishes and Pads



Scotch-Brite™ High Performance Cloth

Ribbon-shaped fibers lift dirt and grease instead of rolling over it. Dirt and particles are trapped within knitted tufts of the fibers. Rows and rows of tufts and valleys trap large and small particles.

Product Name	UPC	Part No.	Size	Color	Material	MOQ
Scotch-Brite™ High Performance Cloth	048011-26224-1	02021	17" x 19-1/2"	White	Polyester/ Nylon	1 case







3M™ Finesse-it™ Hand Sanding Pads

Hand pads used to support 3M™ Finesse-it™ Discs.

Product Name	UPC	Part No.	Desc.	Diameter	Color	Face Color	Density Rating	MOQ	
3M™ Finesse-it™ Hand Sanding Pad		051144-13441-0	13441	—	1-1/4"	Red	Red	Firm	20
		051111-50199-3	50199	—	1-1/4"	Red	Black	Soft	20
		051135-92499-0	70437	Contoured	1-1/4"	Red	Black	Soft	20

3M™ Finesse-it™ Roloc™ Backup Pads





Soft foam pads for application of polishes and glazes to remove haze and swirls. Use with 3M™ Hookit™ Discs Pads. 3M™ Hookit™ Attachment System.

Product Name	UPC	Part No.	Diameter	Thick-ness	Thread Size	Density Rating	Hook Type/ Face	Max RPM (OPM)	MOQ	
3M™ Finesse-it™ Roloc™ Finishing Disc Pad		051144-14736-6	14736U	3"	1"	Roloc™ TR	Firm	3	6,000 (10,000)	12
		051111-51168-8	14736V	3"	1"	Roloc™ TR	Firm	1	6,000 (10,000)	12
3M™ Finesse-it™ Roloc™ Sanding Pad		051111-51150-3	02511	1-1/4"	5/16"	Roloc™ TR	Firm	Blue Vinyl	10,000 (12,000)	10
		051144-13442-7	13442	1-1/4"	5/16"	Roloc™ TR	Medium	Black Rubber	6,000 (10,000)	10
		051144-82271-3	82271	1-1/4"	5/16"	Roloc™ TR	Soft	Black Rubber	6,000 (10,000)	10
3M™ Stikit™ Roloc™ Disc Pad		051111-55833-1	02727	1-1/4"	5/16"	Roloc™ TR	Medium	Black Vinyl	10,000 (12,000)	10

3M™ Finesse-it™ Compounds, Polishes and Pads



3M™ Finesse-it™ Roloc™ Backup Pads (cont.)

Soft foam pads for application of polishes and glazes to remove haze and swirls. Use with 3M™ Hookit™ Discs Pads. 3M™ Hookit™ Attachment System.

Product Name	UPC	Part No.	Diameter	Thick-ness	Thread Size	Density Rating	Hook Type/ Face	Max RPM (OPM)	MOQ	
3M™ Finesse-it™ Roloc™ Sanding Pad		051111-50198-6	02345	1-1/4"	5/16"	Roloc™ TR	Medium	Blue Vinyl	10,000 (12,000)	20
		051141-28584-9	28584	1-1/4"	5/16"	Roloc™ TR	Medium	Blue Vinyl	10,000 (12,000)	100
		051141-28738-6	28738	3/4"	5/16"	Roloc™ TR	Medium	Blue Vinyl	12,000 (12,000)	20
		051141-28768-3	28768	7/8"	5/16"	Roloc™ TR	Medium	Blue Vinyl	12,000 (12,000)	20

3M™ Hookit™ Polishing Pads







Soft foam pads for application of polishes and glazes to remove haze and swirls. Use with 3M™ Hookit™ Discs Pads. 3M™ Hookit™ Attachment System.

Product Name	UPC	Part No.	Desc.	Diameter	Thickness	Color	Density Rating	MOQ	
3M™ Perfect-it™ Hookit™ Foam Polishing Pad		051131-05726-5	05726	Waffle Face	3"	1"	Black	Soft	10
		051131-05727-2	05727	Waffle Face	5-1/4"	1"	Black	Soft	12

3M™ Flanges

3M™ Flange Adapters



Flanges are metal products used to reduce an internal diameter core size to a smaller size.

Product Name	UPC	Part No.	Description	Diameter	Inside Diameter	Width	MOQ	
3M™ Flange Adapter 3		051144-45035-0	45035	<ul style="list-style-type: none"> Reduce 1" ID core size, flange size or wheel size to fit shafts smaller than 1" diameter Stamped and formed sheet metal product Fits 5"–8" diameter flap wheels 	1"	1/2"	—	1
		051144-45033-6	45033	<ul style="list-style-type: none"> Reduce 1" ID core size, flange size or wheel size to fit shafts smaller than 1" diameter Stamped and formed sheet metal product Fits 5"–8" diameter flap wheels 	1"	3/4"	—	1
		051144-45034-3	45034	<ul style="list-style-type: none"> Reduce 1" ID core size, flange size or wheel size to fit shafts smaller than 1" diameter Stamped and formed sheet metal product Fits 5"–8" diameter flap wheels 	1"	5/8"	—	1
		051144-45032-9	45032	<ul style="list-style-type: none"> Reduce 1" ID core size, flange size or wheel size to fit shafts smaller than 1" diameter Stamped and formed sheet metal product Fits 5"–8" diameter flap wheels 	1"	7/8"	—	1
3M™ Flange Adapter 5		048011-16860-9	5	<ul style="list-style-type: none"> Telescoping wheel adapter 1" wide Reduce 1" wheel to fit 1/2", 5/8", 3/4" or 7/8" shafts Use with a set of flat or cupped washers 1/3 the diameter of the wheel for side support 	1"	1/2"	1"	1
		048011-33966-5	5	<ul style="list-style-type: none"> Telescoping wheel adapter 1" wide Reduce 1" wheel to fit 1/2", 5/8", 3/4" or 7/8" shafts Use with a set of flat or cupped washers 1/3 the diameter of the wheel for side support 	1"	1/2"	1"	50
		048011-16859-3	5	<ul style="list-style-type: none"> Telescoping wheel adapter 1/2" wide Reduce 1" wheel to fit 1/2", 5/8", 3/4" or 7/8" shafts Use with a set of flat or cupped washers 1/3 the diameter of the wheel for side support 	1"	1/2"	1/2"	1

3M™ RX Hub and Roto Peen Assembly

3M™ RX Hub and Heavy Duty Roto Peen Hub Assembly

Hub measures 4" diameter with a 2-1/8" ID and is furnished with flanges. The 4" diameter Hub has 20 slots. When ordering specify Hub Diameter x Hub Width x Flange Arbor Hole (D x W x AH).

Product Name	UPC	Part No.	Diameter	Width	Center Hole	MOQ	
3M™ Coated Abrasives, Kut Accessories, RX Hub		051135-92689-5	Determined by width*	4"	Per order	Per order	1
3M™ Heavy Duty Roto Peen, Hub Assembly		048011-91136-6	91136	4"	Per order	Per order	1

*Make-to-order

3M™ Flap Disc Adapter Nut and Holder

3M™ Flap Disc Adapter Nut

Adapter nut to be used with 3M™ Abrasive Flap Discs.

Product Name	UPC	Part No.	Thread Size	MOQ
3M™ Flap Disc Adapter Nut	051144-88765-1	88765	5/8-11 INT	5



3M™ Flap Disc Holder

Holder for 7" diameter 3M™ Abrasive Flap Discs and 6" diameter 3M™ Clean and Strip Cup Wheel.

Product Name	UPC	Part No.	Diameter	Thread Size	MOQ
3M™ Flap Disc Holder T27	051144-88769-9	88769	4"	5/8-11 INT	1



3M™ Flexible Grinding Wheel Backup Pads

3M™ Flexible Grinding Wheel Backup Pads

Clear plastic support plate used to support flexible grinding wheel.

Product Name	UPC	Part No.	Diameter	Center Hole	Color	MOQ
3M™ Flexible Grinding Wheel Backup Pad	051111-51045-2	51045	4-5/8"	7/8"	Clear	5
	051111-51046-9	51046	3-3/8"	7/8"	Clear	5



Hand Pads, Blocks and Holders

3M™ Center Water Feed Disc Hand Pads

Pads supply water to the job and dispense the proper amount of water for wet sanding of plastics, primer surface, paint, fiberglass, etc. The water flushes the sanding residue off the sanding disc which keeps the disc from loading.

Product Name	UPC	Part No.	Desc.	Shape	Diameter	Center Hole	Color	Face Color	Density Rating	Hook Type	MOQ
3M™ Center Water Feed Disc Hand Pad Replacement Sponge	051144-82191-4	82191	Sponge	—	7/8"	—	Yellow	—	—	—	10
3M™ Hookit™ Center Water Feed Disc Hand Pad	051111-56445-5	70147	Hookit	Contoured	3"	7/8"	Yellow	Yellow	Firm	1	10
	051144-82457-1	82457	Hookit	Bullet	3"	7/8"	Yellow	Yellow	Firm	1	10
	051144-88741-5	88741	Hookit	Bullet	2"	5/8"	Yellow	Yellow	Firm	1	10
3M™ Stikit™ Center Water Feed Disc Hand Pad	051144-77749-5	77749	Stikit	Bullet	3"	7/8"	Orange	Blue	Soft	—	10
	051144-82705-3	82705	Stikit	Bullet	3"	7/8"	Yellow	Blue	Firm	—	10

3M™ Wetordry™ Bucket

Product Name	UPC	Part No.	Color	MOQ
3M™ Wetordry™ Bucket	051131-02513-4	02513	Red	10

3M™ Rubber Sanding Blocks

Rectangular sanding blocks for holding abrasive sheets.

Product Name	UPC	Part No.	Size	Color	MOQ
3M™ Rubber Sanding Block	051144-05519-7	05519	2-3/4" x 5"	Red	10
	051131-05520-9	05520	2-3/4" x 8"	Black	10

Hand Pads, Blocks and Holders







Pad Holders

Holders used to drive nonwoven surface conditioning products.

Product Name	UPC	Part No.	Description	Size	Color	Face Color	Material	Hook Type	MOQ
3M™ Doodlebug™ Pad Holder		048011-12929-7	250 Doodlebug	4" x 9-1/4"	Light Gray	Light Gray	Polypropylene	7	5
		048011-33608-4	250HD Doodlebug	3-3/4" x 9"	Light Gray	White/Light Gray	Polypropylene	4	5
3M™ Hook-and-Loop Pad Holder		051141-28384-5	250BP Doodlebug	3-3/4" x 9"	Light Gray	White	Polypropylene	4	5
3M™ Twist-Lok™ Pad Holder		048011-09493-4	961 Hand Block	3-1/2" x 4-3/4" (Height: 2-1/2")	Light Gray	Gray	Plastic	7	1
Scotch-Brite™ Conformable Applicator Cleaner Head		048011-05717-0	261 Conformable	6" x 12"	Dark Gray	Black	Nylon	2	1
3M™ Insta-Lok™ Hand Block		048011-04013-4	952 Insta-Lok Hand Block, Firm	3-3/8" x 5-3/4"	Blue	Tan	Plastic	4	10

3M™ Hookit™ Hand Pads and Blocks









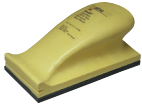

For use with 3M™ Hookit™ Sheets. Available in various densities and thicknesses for your hand sanding needs.

Product Name	UPC	Part No.	Shape	Size	Thickness	Color	Face Color	Density Rating	Hook Type	MOQ	
3M™ Hookit™ Disc Hand Pad		051111-55766-2	01908	Contoured	3" Dia	—	Yellow	Yellow	Firm	1	10
		051144-77750-1	77750	—	5" Dia	1"	Black	Black	Soft	1	10
		051144-77752-5	77752	—	5" Dia	1/4"	Black	Black	Soft	1	20
		051144-85095-2	85095	Contoured	5" Dia	—	Yellow	Yellow	Firm	1	10
		051111-56493-6	88132	Half Round	5" Dia	1/4"	Black	Black	Medium	1	20
		051131-05791-3	05791	—	6" Dia	1/4"	Black	Black	Soft	1	1
		051141-28777-5	28777	—	8" Dia	1-1/8"	Black	Black	Soft	1	1

Hand Pads, Blocks and Holders





3M™ Hookit™ Hand Pads and Blocks (cont.)

For use with 3M™ Hookit™ Sheets. Available in various densities and thicknesses for your hand sanding needs.

Product Name	Image	UPC	Part No.	Shape	Size	Thickness	Color	Face Color	Density Rating	Hook Type	MOQ
3M™ Hookit™ Half Round Pad		051131-05792-0	05792	Half Round	6" Dia	1/4"	Black	Black	Medium	1	20
3M™ Hookit™ Hand Block		051131-05740-1	05740	—	2-3/4" x 5"	—	Yellow	Black	Firm	1	10
		051131-05741-8	05741	—	2-3/4" x 7-3/4"	—	Yellow	Black	Firm	1	10
3M™ Hookit™ Soft Hand Block		051131-05742-5	05742	—	2-3/4" x 5"	—	Yellow	Yellow	Soft	1	10
3M™ Hookit™ Sanding Block		051131-05690-9	05690	—	2-1/2" x 5-3/8"	5/8"	Yellow	Yellow	—	1	24
		051131-05685-5	05685	—	1-3/8" x 10-3/4"	7/8"	Yellow	Yellow	—	1	24
		051131-05686-2	05686	—	2-5/8" x 5-1/4"	1-1/2"	Yellow	Yellow	—	1	24
		051131-05687-9	05687	—	2-5/8" x 10-3/4"	1-1/2"	Yellow	Yellow	—	1	12
		051131-05688-6	05688	—	2-5/8" x 16"	1-1/2"	Yellow	Yellow	—	1	8
3M™ Hookit™ Sanding Block Round		051131-05689-3	05689	Round	1-1/4" x 10-3/4"	—	Yellow	Yellow	—	1	24
3M™ Hookit™ Sanding Block Teardrop		051131-05691-6	05691	Teardrop	2-1/8" x 10-3/4"	—	Yellow	Yellow	—	1	12
3M™ Hookit™ Sanding Block Kit		051131-05684-8	05684	—	24" x 18"	—	Yellow	Yellow	—	1	6





Hand Pads, Blocks and Holders

3M™ Dust Free Hand Pads and Blocks

Product Name	UPC	Part No.	Size	Color	Density Rating	Hook Type	MOQ	
3M™ Hookit™ Sanding Block Dust Free		051131-05207-9	05207	70mm x 127mm	Purple	Firm	1	5
		051131-05208-6	05208	70mm x 198mm	Purple	Firm	1	5
		051131-05209-3	05209	70mm x 396mm	Purple	Firm	1	1
		051131-05216-1	05216	115mm x 225mm	Purple	Firm	1	3
3M™ Dust Free Hose Extension Kit		051131-05215-4	05215	—	Black	—	—	1

3M™ Fairing and Hand File Boards

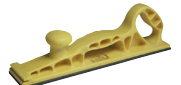
Designed for fairing, shaping, sanding and finishing boats, plugs and molds. Durable, lightweight construction that combines worker comfort and getting desired results quickly.

Product Name	UPC	Part No.	Size	Color	Face Color	Hook Type	MOQ	
3M™ Hookit™ Marine Fairing Board, Flexible		051144-83978-0	83978	4-1/2" x 30"	Yellow	Yellow	1	1
3M™ Imperial™ Hookit™ Marine Fairing Board, Rigid		051144-83497-6	83497	4-1/2" x 30"	Yellow	Yellow	1	1
3M™ Hookit™ Hand File Board		051131-05744-9	05744	2-3/4" x 16"	Yellow	Black	1	1
3M™ Stikit™ Hand File Board		051144-05444-2	05444	2-3/4" x 16"	Yellow	Blue	—	1

Hand Pads, Blocks and Holders

Air File Shoes

For use on Pneumatic Orbital Air Files. Shoes feature a tuck-in clip on the leading edge for easy insertion and quick application and removal.

Product Name	UPC	Part No.	Description	Size	MOQ
3M™ Hookit™ Straightline Air File Shoe	051131-05748-7	05748	<ul style="list-style-type: none"> • For use with 3M™ Hookit™ abrasives for multiple sanding applications • 3M™ Hookit™ pad face provides excellent adhesion and easy removal of the D/F abrasive sheets • Hook Type 1 	2-3/4" x 16"	5
3M™ Stikit™ Air File Shoe	051144-05448-0	05448	<ul style="list-style-type: none"> • For use on all straight air files with 3M™ Stikit™ File Sheets 	2-3/4" x 16"	5
3M™ Hookit™ Short Air File Shoe	051131-05750-0	05750	<ul style="list-style-type: none"> • Aluminum • Rigid 	2-3/4" x 11"	5
3M™ Hookit™ Orbital Air File Shoe	051131-05746-3	05746	<ul style="list-style-type: none"> • Aluminum • Rigid 	2-3/4" x 16"	5
3M™ Hookit™ Straightline File Shoe D/F	051131-05848-4	05848	<ul style="list-style-type: none"> • Aluminum • Rigid 	2-3/4" x 16"	5

3M™ Facing Material Roll







Convert self-made fairing boards to the 3M™ Hookit™ Attachment System. Use 3M™ General Trim Adhesive for bonding 3M™ Hookit™ Facing Roll Material with high performance 3M™ Hookit™ Abrasive Sheets to wood surfaces.

Product Name	UPC	Part No.	Size	Color	Hook Type	MOQ
3M™ Hookit™ Facing Roll	051111-50197-9	88044	4-1/8" x 12 ft.	Black	1	1

Hand Pads, Blocks and Holders

3M™ Stikit™ Hand Pads and Blocks

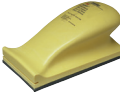
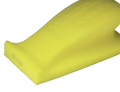



Hand pads designed to support 3M™ Stikit™ Discs and Sheets.

Product Name	UPC	Part No.	Size	Thickness	Foam Color	Face Color	Density Rating	MOQ	
3M™ Stikit™ Disc Hand Pad		051111-56462-2	06624	5" Dia (Half Round)	3/8"	Black	Blue	Medium	20
		051144-45188-3	45188	5" Dia	1/8"	Black	Blue	Medium	20
		051144-45189-0	45189	5" Dia	1/4"	Black	Blue	Medium	20
		051144-11063-6	11063	5" Dia	1"	Black	Black	Soft	10
		051144-84229-2	84229	5" Dia	1"	Black	Blue	Soft	10
		051144-45198-2	45198	6" Dia	1/8"	Black	Blue	Medium	20
		051131-05591-9	05591	6" Dia	1/4"	Black	Blue	Medium	20
		051131-05589-6	05589	6" Dia	1"	Black	Black	Soft	40
3M™ Stikit™ Hand Pad		051144-05585-2	05585	2-3/4" x 5"	3/8"	Black	Black	Medium	10
		051144-05586-9	05586	2-3/4" x 6"	3/8"	Black	Black	Medium	10
3M™ Stikit™ Hand Block		051144-05440-4	05440	2-3/4" x 5"	—	Yellow	Blue	Hard	10
		051144-05441-1	05441	2-3/4" x 7-3/4"	—	Yellow	Blue	Hard	10
3M™ Stikit™ Soft Hand Block		051144-05442-8	05442	2-3/4" x 5"	—	Yellow	Blue	Soft	10
3M™ Stikit™ Soft Hand Pad		051144-05530-2	05530	2-3/4" x 5-1/2"	3/8"	Black	Black	Soft	50
3M™ Wetordry™ Sponge Pad 20		051131-05526-1	05526	5-1/2" x 2-3/4"	3/8"	Black	Black	Soft	50

Hand Pads, Blocks and Holders





3M™ Stikit™ Hand Pads and Blocks (cont.)

Hand pads designed to support 3M™ Stikit™ Discs and Sheets.

Product Name	UPC	Part No.	Size	Foam Color	Face Color	Density Rating	MOQ	
3M™ Stikit™ Sanding Block		051144-45203-3	45203	2-1/2"	Red	White	Firm	6
		051144-45204-0	45204	3-1/4"	Red	White	Firm	6
3M™ Stikit™ Sanding Block Teardrop		051131-05669-5	05669	2-1/8" x 10-3/4"	—	—	—	12
3M™ Stikit™ Sanding Stick Kit		051131-05671-8	05671	—	—	—	10	
3M™ Stikit™ Sanding Block Kit		051131-05692-3	05692	—	—	—	6	

3M™ Screen Cloth Hand Pads



For use with screen cloth discs with two tabs (Die #500GC, 600JR and 800JM). This two-sided durable pad allows the screen cloth disc to be held onto the pad without using adhesive.

Product Name	UPC	Part No.	Diameter	Thickness	Color	Face Color	Density Rating	MOQ	
3M™ Screen Cloth Disc Hand Pad		051111-55845-4	02712	5"	1"	Gray	Black	Medium	10
		051111-60788-6	99736	6"	1"	Black	Black	Soft	10
		051111-55846-1	02713	8"	1"	Gray	Black	Medium	10
		051144-82793-0	82793	8"	1"	Black	Black	Soft	40

Mandrels and Spindles

3M™ Cartridge Roll Mandrels

Mandrel for use with cartridge rolls to help you get to all the hard-to-get at areas on your work pieces.

Product Name	UPC	Part No.	Pilot Diameter	Pilot Length	Shank Size	Overall Length	Max RPM	MOQ	
3M™ Cartridge Roll Mandrel		051144-45116-6	45116	1/4"	1-1/2"	1/4"	3-1/2"	24,000	25
		051144-45117-3	45117	3/16"	1"	1/4"	3"	24,000	25
		051144-45118-0	45118	3/16"	1-1/2"	1/4"	3-1/2"	24,000	25
		051144-45119-7	45119	1/8"	1"	1/4"	2-3/4"	24,000	25
		051144-45120-3	45120	3/32"	3/4"	1/4"	2-3/4"	24,000	25



*OUS only

3M™ Forked Spindle

Forked spindle holder for coated abrasive strips to clean and polish inner diameters and other tight areas.

Product Name	UPC	Part No.	Slot Width	Slot Length	Shank Size	Overall Length	MOQ	
3M™ Forked Spindle		051144-45121-0	45121	1/16"	3/4"	1/4"	3"	10

3M™ Mandrels

Product Name	UPC	Part No.	Shank Size	Overall Length	Outside Flange Diameter	Max RPM	MOQ	
3M™ Mini Mandrel		048011-04020-2	935	1/4"	2-7/8"	—	14,000	5
3M™ Wheel Mandrel		048011-07491-7	938	1/4"	2"	2"	—	1

3M™ Roloc™ Mandrel TS/TSM



Use with 3/4" 3M™ Roloc™ Discs. Designed for cleaning and finishing of airplane seat track channels.

Product Name	UPC	Part No.	Desc.	Thread Size	Shank Size	Overall Length	MOQ	
3M™ Roloc™ Mandrel TS/TSM		051144-85097-6	85097	Track Cleaning	Roloc™ TS or TSM	1/4"	2"	5

Mandrels and Spindles

3M™ Square/Cross Pad Mandrel

Used for tightly securing Square Pads and Cross Pads with internal threaded inserts. Mandrel has external threaded shank.

Product Name	UPC	Part No.	Thread Size	Shank Size	Overall Length	Max RPM	MOQ	
3M™ Square/Cross Pad Mandrel		051141-28385-2	28385	3-48 EXT	1/4"	3"	24,100	5
		051144-14307-8	14307	8-32 EXT	1/4"	3"	24,100	1
		051144-14308-5	14308	1/4-20 EXT	1/4"	3"	24,100	1





3M™ Star Mandrel

Mandrel for a surface conditioning star converted into a unique shape for cleaning, polishing and light deburring of inside diameters of pipe and tubing. Dually threaded for either spin-on direction with portable hand tools.

Product Name	UPC	Part No.	Thread Size	Shank Size	Overall Length	Max RPM	MOQ	
3M™ Star Mandrel		048011-13928-9	944	1/4-20 EXT	1/4"	3"	24,100	1

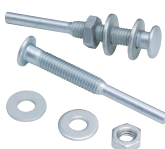
3M™ Unitized Wheel Mandrels









Recommended for use on portable tools. Excellent for edge deburring and finishing applications of small or intricate work pieces. They are available in a wide range of diameters, grades and densities and limited to a thickness no more than 1".

Product Name	UPC	Part No.	Description	Shank Size	Overall Length	Outside Flange Diameter	Max RPM	MOQ	
3M™ Unitized Wheel Mandrel		048011-13966-1	931	<ul style="list-style-type: none"> Use with wheels 1" to 1-1/2" diameter x 1/4" wide x 1/8" center hole Maximum wheel width: 1/4" Note: 5/16" center hole is recommended for wheels 6 density or harder 	1/8"	1-1/2"	1/2"	13,000	5
		048011-13967-8	932	<ul style="list-style-type: none"> Use with wheels 1-1/2" to 2" diameter x 1/4" to 1/2" wide x 1/4" center hole Maximum wheel width: 1/2" Note: 5/16" center hole is recommended for wheels 6 density or harder 	1/4"	2"	3/16"	20,000	5
		048011-13968-5	933	<ul style="list-style-type: none"> Use with wheels 2", 2-1/2" or 3" diameter x 1/4", 1/2", 3/4" wide x 1/4" center hole Maximum wheel width: 1" Note: 5/16" center hole is recommended for wheels 6 density or harder 	1/4"	2"	1"	14,000	5
		048011-04021-9	934	<ul style="list-style-type: none"> Use with wheels 3" to 6" diameter x 1/4", 1/2", 3/4" or 1" wide x 1/2" center hole 	1/4"	3-1/16"	2-1/2"	12,000	1

Mandrels and Spindles

3M™ Unitized Wheel Mandrels (cont.)

Recommended for use on portable tools. Excellent for edge deburring and finishing applications of small or intricate work pieces. They are available in a wide range of diameters, grades and densities and limited to a thickness no more than 1".

Product Name	UPC	Part No.	Description	Shank Size	Overall Length	Outside Flange Diameter	Max RPM	MOQ	
3M™ Unitized Wheel Mandrel		048011-04018-9	936	<ul style="list-style-type: none"> Use with wheels 1" diameter x 1" wide x 3/16" center hole Plastic mandrel self taps into wheel 	1/4"	2-1/16"	3/4"	22,200	5
		048011-15012-3	990	<ul style="list-style-type: none"> Use with high speed or easy loading unitized wheels 2" to 3" diameter x 1/8" to 1/2" wide x 3/8" center hole Includes silver cap for 1/8" and 1/4" wide wheels Includes black cap for 3/8" and 1/2" wide wheels 	1/4"	1-3/4"	1"	25,100	5
	NEW! 	051141-28847-5	28847	<ul style="list-style-type: none"> Use with 2" or 3" diameter, 1/8" thick unitized wheels with 1/4" center hole 	1/4"	1-1/2"	3/4"	18,100 (3") 22,100 (2")	5
	NEW! 	051141-28848-2	28848	<ul style="list-style-type: none"> Use with 2" or 3" diameter, 1/4" thick unitized wheels with 1/4" center hole 	1/4"	1-5/8"	3/4"	18,100 (3") 22,100 (2")	5
	NEW! 	051141-28849-9	28849	<ul style="list-style-type: none"> Use with 2" or 3" diameter, 1/2" thick unitized wheels with 1/4" center hole 	1/4"	1-7/8"	3/4"	18,100 (3") 22,100 (2")	5
	NEW! 	051141-28850-5	28850	<ul style="list-style-type: none"> Use with 2" or 3" diameter, 3/4" thick unitized wheels with 1/4" center hole 	1/4"	2-1/8"	3/4"	16,100 (3") 18,100 (2")	5
	NEW! 	051141-28851-2	28851	<ul style="list-style-type: none"> Use with 2" or 3" diameter, 1" thick unitized wheels with 1/4" center hole 	1/4"	2-3/8"	3/4"	16,100 (3") 18,100 (2")	5
	NEW! 	051141-28838-3	28838	<ul style="list-style-type: none"> Use with 3" diameter, 1/8" to 1/2" thick, 1/4" center hole deburr & finish unitized wheels 	1/4"	2-1/2"	1"	18,100	5

3M™ Platen Pad Cover

3M™ Platen Pad Cover

Silver cloth with Pressure Sensitive Adhesive backing used to protect platen pads.

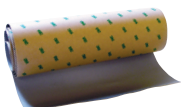
Product Name	UPC	Part No.	Size	Face Color	MOQ	
3M™ Platen Pad Cover		051111-56599-5	06541	10-1/2" x 53"	Silver	1

3M™ Roto Peen Accessories

3M™ Roto Peen Accessories

Product Name	UPC	Part No.	Description	Length	Slot Width	Width	MOQ
3M™ Roto Peen Almen Strip Holder	048011-03764-6	ALMEN	Use to hold Almen Strips for testing peening intensity	7"	1"	2"	1
3M™ Roto Peen Assembly Kit 09041	048011-17157-9	09041	Convenient kit contains a 3M™ Roto Peen Almen Strip Holder, two sizes of Roto Peen Flap Assemblies TC-330, and Roto Peen Mandrels 7210 and 7211	—	—	—	1
3M™ Roto Peen Mandrel	048011-03768-4	7210	Use with 3M™ Roto Peen Flap Assemblies 9/16" x 1-1/4"	3"	1/16"	1/4" Dia.	1
	048011-03767-7	7211	Use with 3M™ Roto Peen Flap Assemblies 1" x 2"	8"	1/16"	3/8" Dia.	1
	048011-05969-3	7212	Use with 3M™ Roto Peen Flap Assemblies 9/16" x 1"	3"	1/16"	1/4" Dia.	1

Molding Adhesive and Stripe Removal

Molding Adhesive and Stripe Removal

















Used to remove vinyl stripes, numbers, letters and graphics from gel coat and painted marine surfaces without damaging the finish.

Product Name	UPC	Part No.	Desc.	Diameter	Thick-ness	Center Hole	Thread Size	Color	Density Rating	Max RPM	MOQ
Scotch-Brite™ Molding Adhesive and Stripe Removal Disc	051131-07501-6	07501	Foam Disc	4"	—	3/8"	—	White	—	4,000	5
	051131-07502-3	07502	Foam Disc	6"	—	3/8"	—	White	—	2,800	5
Scotch-Brite™ Large Area Stripe Removal Disc	051131-07517-7	07517	Foam Disc	8"	—	5/8"	—	White	—	3,000	1
3M™ Stripe Off Wheel	051131-07498-9	07498	Wheel With Mandrel	4"	5/8"	—	3/8-16 INT	Beige	Medium	4,000	5
	051131-07499-6	07499	Wheel	4"	5/8"	—	3/8-16 INT	Beige	Medium	4,000	5

3M™ Rubber Cushion Polishing Wheels

3M™ Rubber Cushion Polishing Wheels

A mechanically expandable rubber cushion available in a wide variety of sizes safely keeps 3M™ Bands and Belts from slipping during use with 3M™ Coated Abrasive Bands and Belts.







Product Name	UPC	Part No.	Diameter	Width	Shank Size	Color	Max RPM	MOQ
	051144-45159-3	45159	1/4"	1/2"	1/8"	Black	23,000	1
	051144-45153-1	45153	1/2"	1"	1/4"	Black	15,000	1
	051144-45156-2	45156	1/2"	1/2"	1/4"	Black	30,000	1
	051144-45152-4	45152	1/2"	1-1/2"	1/4"	Black	15,000	1
	051144-45145-6	45145	3/4"	1"	1/4"	Black	17,000	1
	051144-45148-7	45148	3/4"	1/2"	1/4"	Black	30,000	1
	051144-45144-9	45144	3/4"	1-1/2"	1/4"	Black	10,000	1
	051144-45146-3	45146	3/4"	3/4"	1/4"	Black	24,000	1
	051144-45139-5	45139	1"	1"	1/4"	Black	18,000	1
	051144-45138-8	45138	1"	1-1/2"	1/4"	Black	10,000	1
	051144-45137-1	45137	1"	2"	1/4"	Black	8,000	1
	051144-45132-6	45132	1-1/2"	1"	1/4"	Black	14,000	1
	051144-45131-9	45131	1-1/2"	1-1/2"	1/4"	Black	10,000	1
	051144-45130-2	45130	1-1/2"	2"	1/4"	Black	8,000	1
	051144-45129-6	45129	2"	1"	1/4"	Black	11,000	1
	051144-45127-2	45127	2"	2"	1/4"	Black	6,000	1
	051144-45123-4	45123	3"	3"	1/2"	Black	3,000	1

3M™ Rubber Cushion Polishing Wheel

3M™ Rubber Slotted Expander Wheels

3M™ Rubber Slotted Expander Wheels

Slotted wheels available in a wide variety of sizes for use with 3M™ Bands and Belts. Centrifugal force while tool is running holds band on expander wheel.



Product Name	UPC	Part No.	Diameter	Width	Center Hole	Thread Size	Shank Size	Color	Density Rating	Max RPM	MOQ	
3M™ Rubber Slotted Expander Wheel		051144-77717-4	77717	1"	1"	—	—	1/4"	Black	Medium	18,000	1
		051144-77718-1	77718	1-1/2"	1"	—	—	1/4"	Black	Medium	14,000	1
		051144-77722-8	77722	3"	3"	—	5/8-11 INT	—	Black	Medium	6,000	1
		051141-28349-4	28349*	3-2/5"	3"	5/8"	—	—	Black	Soft	3,500	1
		051141-28348-7	28348**	5"	3-1/2"	5/8"	—	—	Black	Soft	3,500	1
		051141-28718-8	28718	5"	3-1/2"	1"	—	—	Black	Soft	3,500	1

*3" x 10-11/16" Belt **3-1/2" x 10-15-1/2" Belt

3M™ Wetordry™ Rubber Squeegees

3M™ Wetordry™ Rubber Squeegees



Flexible, sturdy rubber used for removing slush created when sanding or applying glazing putty and plastic filler.

Product Name	UPC	Part No.	Size	Thickness	Color	Density Rating	MOQ	
3M™ Wetordry™ Rubber Squeegee		051144-05518-0	05518	2" x 3"	3/16"	Black	Firm	50
		051144-05517-3	05517	2-3/4" x 4-1/4"	3/16"	Black	Firm	50

3M™ All Purpose Tack Cloth

3M™ All Purpose Tack Cloth

3M™ All Purpose Tack Cloth stays soft for a comfortable cleanup just before painting and is reusable. Use to remove dirt, lint, dust and sanding particles from metal, plastic, fiberglass and wood.

Product Name	UPC	Part No.	Size	Color	Material	MOQ	
3M™ Tack Pad		034375-38318-4	07910	175mm x 235mm	White	Foam	1
3M™ Tack Pad Dispenser		051131-07909-0	07909	—	—	—	1
3M™ Tack Cloth		051111-10132-2	10132NA	17" x 36"	White	Woven Synthetic Fiber	48

UPC Index

UPC	Page	UPC	Page	UPC	Page	UPC	Page
034375-38318-4	52	048011-22972-0	2	051111-60306-2	6	051131-05717-3	34
048011-03764-6	49	048011-27628-1	3	051111-60311-6	13	051131-05718-0	34
048011-03767-7	49	048011-27680-9	3	051111-60527-1	31	051131-05723-4	34
048011-03768-4	49	048011-30095-5	3	051111-60528-8	31	051131-05725-8	34
048011-04013-4	40	048011-30096-2	3	051111-60537-0	31	051131-05726-5	36
048011-04018-9	48	048011-30133-4	3	051111-60788-6	45	051131-05727-2	36
048011-04019-6	2	048011-30134-1	3	051111-60799-2	31	051131-05729-6	34
048011-04020-2	46	048011-33608-4	40	051111-61009-1	30	051131-05740-1	41
048011-04021-9	47	048011-33732-6	28	051111-61104-3	30	051131-05741-8	41
048011-04130-8	8	048011-33733-3	28	051125-87276-8	15	051131-05742-5	41
048011-04132-2	8	048011-33734-0	28	051125-87277-5	16	051131-05744-9	42
048011-05673-9	8	048011-33966-5	37	051125-87391-8	32	051131-05746-3	43
048011-05674-6	8	048011-91136-6	37	051131-02513-4	39	051131-05748-7	43
048011-05677-7	8	051111-10132-2	52	051131-05207-9	42	051131-05750-0	43
048011-05680-7	9	051111-50193-1	33	051131-05208-6	42	051131-05751-7	34
048011-05681-4	9	051111-50197-9	43	051131-05209-3	42	051131-05759-3	34
048011-05682-1	9	051111-50198-6	36	051131-05215-4	42	051131-05760-9	34
048011-05717-0	40	051111-50199-3	35	051131-05216-1	42	051131-05768-5	11
048011-05969-3	49	051111-51042-1	12	051131-05520-9	39	051131-05771-5	16
048011-07491-7	46	051111-51045-2	38	051131-05526-1	44	051131-05775-3	10
048011-07492-4	8	051111-51046-9	38	051131-05538-4	23	051131-05777-7	16
048011-07494-8	8	051111-51047-6	7	051131-05541-4	23	051131-05779-1	11
048011-09448-9	9	051111-51076-6	31	051131-05545-2	19	051131-05781-4	12
048011-09449-6	9	051111-51150-3	35	051131-05546-9	19	051131-05782-1	12
048011-09450-2	9	051111-51151-0	31	051131-05551-3	14	051131-05783-8	12
048011-09451-9	9	051111-51157-2	29	051131-05568-1	19	051131-05791-3	40
048011-09493-4	40	051111-51158-9	31	051131-05581-0	18	051131-05792-0	41
048011-12929-7	40	051111-51168-8	35	051131-05582-7	18	051131-05848-4	43
048011-13928-9	47	051111-55764-8	10	051131-05589-6	44	051131-05855-2	12
048011-13966-1	47	051111-55765-5	24	051131-05591-9	44	051131-05858-3	14
048011-13967-8	47	051111-55766-2	40	051131-05637-4	7	051131-05865-1	14
048011-13968-5	47	051111-55813-3	19	051131-05645-9	18	051131-05876-7	12
048011-14111-4	9	051111-55833-1	35	051131-05646-6	18	051131-06002-9	29
048011-14114-5	9	051111-55845-4	45	051131-05669-5	45	051131-06075-3	29
048011-14915-8	28	051111-55846-1	45	051131-05671-8	45	051131-07390-6	12
048011-15012-3	48	051111-56445-5	39	051131-05684-8	41	051131-07394-4	11
048011-15060-4	28	051111-56459-2	20	051131-05685-5	41	051131-07493-4	8
048011-15408-4	28	051111-56462-2	44	051131-05686-2	41	051131-07498-9	49
048011-16859-3	37	051111-56472-1	19	051131-05687-9	41	051131-07499-6	49
048011-16860-9	37	051111-56479-0	27	051131-05688-6	41	051131-07500-9	28
048011-17157-9	49	051111-56491-2	15	051131-05689-3	41	051131-07501-6	49
048011-18444-9	11	051111-56493-6	40	051131-05690-9	41	051131-07502-3	49
048011-22970-6	2	051111-56573-5	7	051131-05691-6	41	051131-07517-7	49
048011-22971-3	2	051111-56599-5	48	051131-05692-3	45	051131-07545-0	28

UPC Index

UPC	Page	UPC	Page	UPC	Page	UPC	Page
051131-07547-4	28	051141-28324-1	16	051141-28768-3	36	051141-28891-8	9
051131-07715-7	23	051141-28325-8	15	051141-28772-0	19	051141-28892-5	9
051131-07909-0	52	051141-28326-5	16	051141-28777-5	40	051144-05440-4	44
051131-37716-5	34	051141-28348-7	51	051141-28792-8	30	051144-05441-1	44
051131-37720-2	34	051141-28349-4	51	051141-28793-5	30	051144-05442-8	44
051135-92499-0	35	051141-28384-5	40	051141-28794-2	30	051144-05444-2	42
051135-92500-3	31	051141-28385-2	47	051141-28795-9	30	051144-05448-0	43
051135-92689-5	37	051141-28411-8	12	051141-28796-6	30	051144-05450-3	20
051141-20206-8	14	051141-28416-3	6	051141-28797-3	30	051144-05452-7	20
051141-20207-5	31	051141-28417-0	6	051141-28801-7	15	051144-05510-4	21
051141-20271-6	31	051141-28419-4	2	051141-28802-4	15	051144-05517-3	52
051141-20272-3	30	051141-28442-2	6	051141-28803-1	15	051144-05518-0	52
051141-20274-7	31	051141-28443-9	5	051141-28804-8	15	051144-05519-7	39
051141-20278-5	16	051141-28472-9	10	051141-28805-5	15	051144-05530-2	44
051141-20279-2	9	051141-28473-6	27	051141-28806-2	15	051144-05539-5	23
051141-20290-7	14	051141-28474-3	25	051141-28817-8	19	051144-05540-1	23
051141-20348-5	19	051141-28475-0	25	051141-28838-3	48	051144-05575-3	19
051141-20350-8	14	051141-28476-7	6	051141-28845-1	15	051144-05579-1	19
051141-20351-5	19	051141-28531-3	15	051141-28847-5	48	051144-05585-2	44
051141-20352-2	11	051141-28548-1	11	051141-28848-2	48	051144-05586-9	44
051141-20353-9	14	051141-28584-9	36	051141-28849-9	48	051144-05620-0	7
051141-20354-6	19	051141-28625-9	5	051141-28850-5	48	051144-05621-7	7
051141-20355-3	11	051141-28626-6	6	051141-28851-2	48	051144-05622-4	7
051141-20356-0	14	051141-28636-5	2	051141-28852-9	9	051144-05710-8	34
051141-20425-3	14	051141-28637-2	2	051141-28852-9	11	051144-11063-6	44
051141-20427-7	14	051141-28654-9	7	051141-28862-8	33	051144-11823-6	6
051141-20428-4	14	051141-28655-6	13	051141-28863-5	33	051144-11824-3	6
051141-20432-1	20	051141-28656-3	5	051141-28864-2	33	051144-13084-9	29
051141-20433-8	13	051141-28657-0	5	051141-28869-7	32	051144-13325-3	4
051141-20434-5	20	051141-28658-7	5	051141-28870-3	32	051144-13441-0	35
051141-20435-2	15	051141-28660-0	20	051141-28871-0	32	051144-13442-7	35
051141-20439-0	9	051141-28661-7	19	051141-28872-7	32	051144-13627-8	11
051141-20442-0	18	051141-28662-4	10	051141-28873-4	32	051144-14197-5	25
051141-20443-7	16	051141-28695-2	29	051141-28874-1	32	051144-14198-2	25
051141-20444-4	16	051141-28696-9	30	051141-28875-8	32	051144-14201-9	25
051141-20445-1	16	051141-28709-6	11	051141-28876-5	32	051144-14202-6	25
051141-20446-8	16	051141-28710-2	27	051141-28877-2	32	051144-14211-8	26
051141-20454-3	18	051141-28711-9	27	051141-28878-9	32	051144-14212-5	26
051141-20465-9	14	051141-28712-6	25	051141-28879-6	32	051144-14215-6	26
051141-25122-6	12	051141-28713-3	25	051141-28880-2	32	051144-14216-3	26
051141-27819-5	2	051141-28714-0	25	051141-28881-9	29	051144-14270-5	4
051141-28321-0	16	051141-28718-8	51	051141-28888-8	9	051144-14307-8	47
051141-28322-7	16	051141-28738-6	36	051141-28889-5	27	051144-14308-5	47
051141-28323-4	16	051141-28742-3	26	051141-28890-1	9	051144-14736-6	35

UPC Index

UPC	Page	UPC	Page	UPC	Page	UPC	Page
051144-14738-0	31	051144-45146-3	50	051144-81732-0	5	051144-88739-2	10
051144-45032-9	37	051144-45148-7	50	051144-81733-7	5	051144-88741-5	39
051144-45033-6	37	051144-45152-4	50	051144-81734-4	5	051144-88743-9	6
051144-45034-3	37	051144-45153-1	50	051144-81821-1	19	051144-88748-4	24
051144-45035-0	37	051144-45156-2	50	051144-82178-5	19	051144-88753-8	29
051144-45038-1	2	051144-45159-3	50	051144-82191-4	39	051144-88765-1	38
051144-45068-8	21	051144-45179-1	24	051144-82271-3	35	051144-88769-9	38
051144-45069-5	21	051144-45188-3	44	051144-82455-7	22	134375-38286-1	31
051144-45070-1	21	051144-45189-0	44	051144-82457-1	39	134375-38287-8	31
051144-45071-8	21	051144-45190-6	6	051144-82531-8	33		
051144-45072-5	21	051144-45194-4	4	051144-82564-6	13		
051144-45073-2	21	051144-45198-2	44	051144-82565-3	13		
051144-45074-9	21	051144-45203-3	45	051144-82566-0	13		
051144-45081-7	2	051144-45204-0	45	051144-82567-7	13		
051144-45090-9	24	051144-45205-7	6	051144-82659-9	12		
051144-45091-6	24	051144-45208-8	4	051144-82705-3	39		
051144-45092-3	24	051144-45215-6	19	051144-82793-0	45		
051144-45093-0	24	051144-45217-0	18	051144-82877-7	29		
051144-45094-7	24	051144-45218-7	18	051144-82878-4	29		
051144-45095-4	23	051144-77340-4	29	051144-82974-3	27		
051144-45096-1	23	051144-77717-4	51	051144-82975-0	27		
051144-45097-8	23	051144-77718-1	51	051144-83058-9	29		
051144-45098-5	23	051144-77722-8	51	051144-83242-2	24		
051144-45099-2	23	051144-77723-5	25	051144-83489-1	24		
051144-45100-5	23	051144-77724-2	26	051144-83497-6	42		
051144-45101-2	23	051144-77726-6	25	051144-83978-0	42		
051144-45102-9	22	051144-77728-0	26	051144-83980-3	24		
051144-45116-6	46	051144-77729-7	26	051144-84229-2	44		
051144-45117-3	46	051144-77737-2	26	051144-84993-2	24		
051144-45118-0	46	051144-77740-2	26	051144-84998-7	24		
051144-45119-7	46	051144-77749-5	39	051144-84999-4	24		
051144-45120-3	46	051144-77750-1	40	051144-85000-6	24		
051144-45121-0	46	051144-77751-8	11	051144-85078-5	33		
051144-45123-4	50	051144-77752-5	40	051144-85079-2	33		
051144-45127-2	50	051144-77855-3	11	051144-85083-9	33		
051144-45129-6	50	051144-77856-0	12	051144-85084-6	33		
051144-45130-2	50	051144-80514-3	5	051144-85095-2	40		
051144-45131-9	50	051144-80515-0	5	051144-85096-9	10		
051144-45132-6	50	051144-80516-7	5	051144-85099-0	33		
051144-45137-1	50	051144-81235-6	29	051144-85100-3	33		
051144-45138-8	50	051144-81470-1	33	051144-85103-4	33		
051144-45139-5	50	051144-81471-8	33	051144-85104-1	19		
051144-45144-9	50	051144-81728-3	5	051144-85105-8	10		
051144-45145-6	50	051144-81729-0	5	051144-85287-1	13		

Part No. Index

Part No.	Page	Part No.	Page	Part No.	Page	Part No.	Page	Part No.	Page	Part No.	Page	Part No.	Page
ALMEN	49	05216	42	05746	43	14212	26	28474	25	28877	32	45156	50
1	28	05440	44	05748	43	14215	26	28475	25	28878	32	45159	50
1 and 7	28	05441	44	05750	43	14216	26	28476	6	28879	32	45179	24
2	28	05442	44	05751	34	14270	4	28531	15	28880	32	45188	44
3	3, 28	05444	42	05759	34	14307	47	28584	36	28881	29	45189	44
4	28	05448	43	05760	34	14308	47	28636	2	28888	9	45190	6
5	37	05450	20	05768	11	14736U	35	28637	2	28889	27	45194	4
7	28	05452	20	05771	16	14736V	35	28654	7	28890	9	45198	44
8	3	05510	21	05775	10	14738	31	28655	13	28891	9	45203	45
9	2	05517	52	05777	16	18444	11	28656	5	28892	9	45204	45
250	40	05518	52	05779	11	20206	14	28657	5	30133	3	45205	6
250BP	40	05519	39	05781	12	20245	9	28658	5	30134	3	45205L	6
250HD	40	05520	39	05782	12	20271	31	28660	20	37716	34	45208	4
261	40	05526	44	05783	12	20272	30	28661	19	37720	34	45215	19
300	2	05530	44	05791	40	20274	31	28662	10	45032	37	45217	18
905	9	05538	23	05792	41	20278	16	28695	29	45033	37	45218	18
906	9	05539	23	05848	43	20279	9	28696	30	45034	37	50199	35
914	8	05540	23	05855	12	20290	14	28710	27	45035	37	51045	38
915	9	05541	23	05858	14	20348	19	28711	27	45038	2	51046	38
916	9	05545	19	05865	14	20350	14	28712	25	45068	21	51056	29
917	9	05546	19	05876	12	20351	19	28713	25	45069	21	60150	30
918	9	05551	14	06002	29	20352	11	28714	25	45070	21	61104	30
922	8	05568	19	06075	29	20353	14	28718	51	45071	21	67415	13
923	8	05575	19	06541	48	20354	19	28719	2	45072	21	70138	11
924	8	05579	19	06624	44	20355	11	28738	36	45073	21	70147	39
931	47	05581	18	7210	49	20356	14	28742	26	45074	21	70166	15
932	47	05582	18	7211	49	20425	14	28768	36	45081	2	70234	19
934	47	05585	44	7212	49	20427	14	28772	19	45090	24	70437	35
935	46	05586	44	07390	12	20428	14	28777	40	45091	24	70449	19
936	48	05589	44	07394	11	20432	20	28792	30	45092	24	77340	29
938	46	05591	44	7493	8	20433	13	28793	30	45093	24	77717	51
944	47	05620	7	07498	49	20434	20	28794	30	45094	24	77718	51
947	11	05621	7	07499	49	20435	15	28795	30	45095	23	77722	51
952	40	05622	7	07500	28	20439	9	28796	30	45096	23	77723	25
961	40	05637	7	07501	49	20442	18	28797	30	45097	23	77724	26
990	48	05645	18	07502	49	20443	16	28801	15	45098	23	77726	25
01908	40	05646	18	07517	49	20444	16	28802	15	45099	23	77728	26
01912	31	05669	45	07545	28	20445	16	28803	15	45100	23	77729	26
01963	31	05671	45	07547	28	20446	16	28804	15	45101	23	77737	26
02140	7	05684	41	07715	23	20454	18	28805	15	45102	22	77740	26
02286	27	05685	41	07909	52	20465	14	28806	15	45116	46	77749	39
02345	36	05686	41	07910	52	25122	12	28817	19	45117	46	77750	40
02362	31	05687	41	09041	49	27628	3	28838	48	45118	46	77751	11
02362B	31	05688	41	9145	9	27680	3	28845	15	45119	46	77751B	11
02511	35	05689	41	9145	9	28321	16	28847	48	45120	46	77752	40
02513	39	05690	41	9215	8	28322	16	28848	48	45121	46	77855	11
02618	7	05691	41	09357	31	28323	16	28849	48	45123	50	77856	12
02637	31	05692	45	09358	31	28324	16	28850	48	45127	50	80514	5
02648	31	05710	34	10132NA	52	28325	15	28851	48	45129	50	80515	5
02648B	31	05717	34	11063	44	28326	16	28852	11	45130	50	80516	5
02700	10	05718	34	11823	6	28348	51	28862	33	45131	50	81235	29
02712	45	05723	34	11824	6	28349	51	28863	33	45132	50	81470	33
02713	45	05725	34	13084	29	28385	47	28864	33	45137	50	81471	33
02727	35	05726	36	13325	4	28411	12	28869	32	45138	50	81728	5
02795	20	05727	36	13441	35	28416	6	28870	32	45139	50	81729	5
3125H	31	05729	34	13442	35	28417	6	28871	32	45144	50	81732	5
3125P	31	5730	33	14197	25	28419	2	28872	32	45145	50	81732L	5
05207	42	05740	41	14198	25	28442	6	28873	32	45146	50	81733	5
05208	42	05741	41	14201	25	28443	5	28874	32	45148	50	81734	5
05209	42	05742	41	14202	25	28472	10	28875	32	45152	50	81821	19
05215	42	05744	42	14211	26	28473	27	28876	32	45153	50	82178	19

Contact your local 3M authorized distributor directly. For more information on a 3M distributor or sales representative in your area, contact us at the following number:

Contiguous 48 States 866-279-1235 (FAX 651-778-4244)

E-mail us at 3MIndustrial@mmm.com

For additional 3M product information or material data sheets contact us at:

- **866-279-1235**
- **3M.com/abrasives**
- **3M.com/AccessoriesASD**
- **3M.com/SpareParts**

Additional accessories are available and may be purchased directly through Contract Production Services/CPS. Please contact Contract Production Services/CPS directly to check availability and other specific information. Use the part number to identify and specify the desired item.

Contract Production Services/CPS

1936 Lyndale Avenue South	Toll Free: 1-800-843-0619
Minneapolis, MN 55403	Tel: 612-843-3445
CPSabrasives.com	Fax: 612-872-0189
cjones@contactcps.com	

Office Hours: Monday–Thursday, 6:00 a.m.– 4:00 p.m. (Central Time)

Important Notice to Purchaser

Product Selection and Use: Many factors beyond 3M's control and uniquely within user's knowledge and control can affect the use and performance of a 3M product in a particular application. As a result, customer is solely responsible for evaluating the product and determining whether it is appropriate and suitable for customer's application, including conducting a workplace hazard assessment and reviewing all applicable regulations and standards (e.g., OSHA, ANSI, etc.). Failure to properly evaluate, select, and use a 3M product and appropriate safety products, or to meet all applicable safety regulations, may result in injury, sickness, death, and/or harm to property.

Warranty, Limited Remedy, and Disclaimer: Unless a different warranty is specifically stated on the applicable 3M product packaging or product literature (in which case such warranty governs), 3M warrants that each 3M product meets the applicable 3M product specification at the time 3M ships the product. 3M MAKES NO OTHER WARRANTIES OR CONDITIONS, EXPRESS OR IMPLIED, INCLUDING, BUT NOT LIMITED TO, ANY IMPLIED WARRANTY OR CONDITION OF MERCHANTABILITY, FITNESS FOR A PARTICULAR PURPOSE, OR ARISING OUT OF A COURSE OF DEALING, CUSTOM, OR USAGE OF TRADE. If a 3M product does not conform to this warranty, then the sole and exclusive remedy is, at 3M's option, replacement of the 3M product or refund of the purchase price.

Limitation of Liability: Except for the limited remedy stated above, and except to the extent prohibited by law, 3M will not be liable for any loss or damage arising from or related to the 3M product, whether direct, indirect, special, incidental, or consequential (including, but not limited to, lost profits or business opportunity), regardless of the legal or equitable theory asserted, including, but not limited to, warranty, contract, negligence, or strict liability.



3M Abrasive Systems Division
3M Center
Building 223-6S-03
St. Paul, MN 55144-1000

3M, Doodlebug, Dual Lock, Finesse-it, Hookit, Imperial, Insta-Lok, Perfect-it, Roloc, Scotch-Brite, Stikit, Twist-Lok and Wetordry are all trademarks of 3M. Used under license in Canada. All other trademarks are the property of their respective owners.