

# RATIO OUTDOOR LUMINAIRE FAMILY





# RATIO AREA/SITE

Hubbell Outdoor Lighting's Ratio area/site family is available in two sizes as well as a variety of outputs allowing you to customize your lighting design to meet application requirements. With a new spin on a classic rectilinear form, Ratio brings the traditional shoebox aesthetic into the next generation of LED lighting. Ratio features a dense optical array which provides reduced pixilation and increased visual comfort without compromising performance. Designed for sustained, long-term performance with advanced thermal management, an elegantly simple heat sink and industry leading surge protection.



## VERSATILE MOUNTING

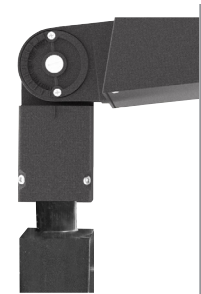

Knuckle

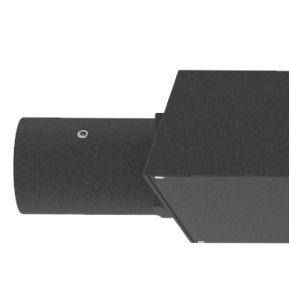

Mast Arm

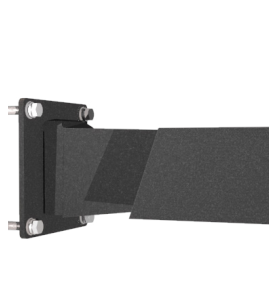

Wall Mount

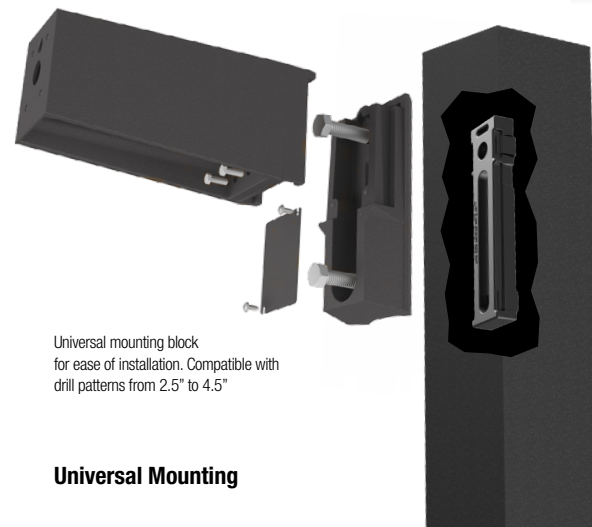

Universal mounting block for ease of installation. Compatible with drill patterns from 2.5" to 4.5"

Universal Mounting

Size	RAR1-80L	RAR1-160L	RAR2-320L	RAR2-480L
Lumens	3,000/6,000	9,000/12,000	15,000/21,000	24,000/30,000
Watts	25/50W	70/100W	110-165W	185-240W
LPW	120	129	136	136
Mounting	Arm & Knuckle	Arm & Knuckle	Arm & Knuckle	Arm & Knuckle
CCT	3K, 4K, 5K	3K, 4K, 5K	3K, 4K, 5K	3K, 4K, 5K
Distributions	II, III, IV, V	II, III, IV, V	II, III, IV, V	II, III, IV, V
IP Rating	IP66	IP66	IP66	IP66
Legacy Equivalence	100-175W	175-250W	250-400W	400-750W



# RATIO AREA/SITE - PERFORMANCE

## IES COMPARISON

The Ratio is available with four distinct distribution patterns to illuminate a variety of applications. Featuring Micro Strike Optics which maximizes target zone illumination with minimal losses at the house-side, reducing light trespass issues. This outstanding optic control simplifies layouts and installations, reducing pole count, energy consumption, lowers installation costs and improves visual acuity.

Luminaire	Parking Area									
	Illuminance (Fc)					Output				
	Minimum	Average	Maximum	Avg/Min	Max/Min	Watts	Lumens	Pole Spacing	# Of Poles	Total Watts
RAR-2-480L-210-4K7-4 @ 25' MH	1.4	3.0	6.6	2.1	4.7	210	27,000	130'	4	840
Typical Area/Site Luminaire @ 25' MH	1.0	2.9	8.3	2.9	8.3	215	27,524	100'	6	1,290

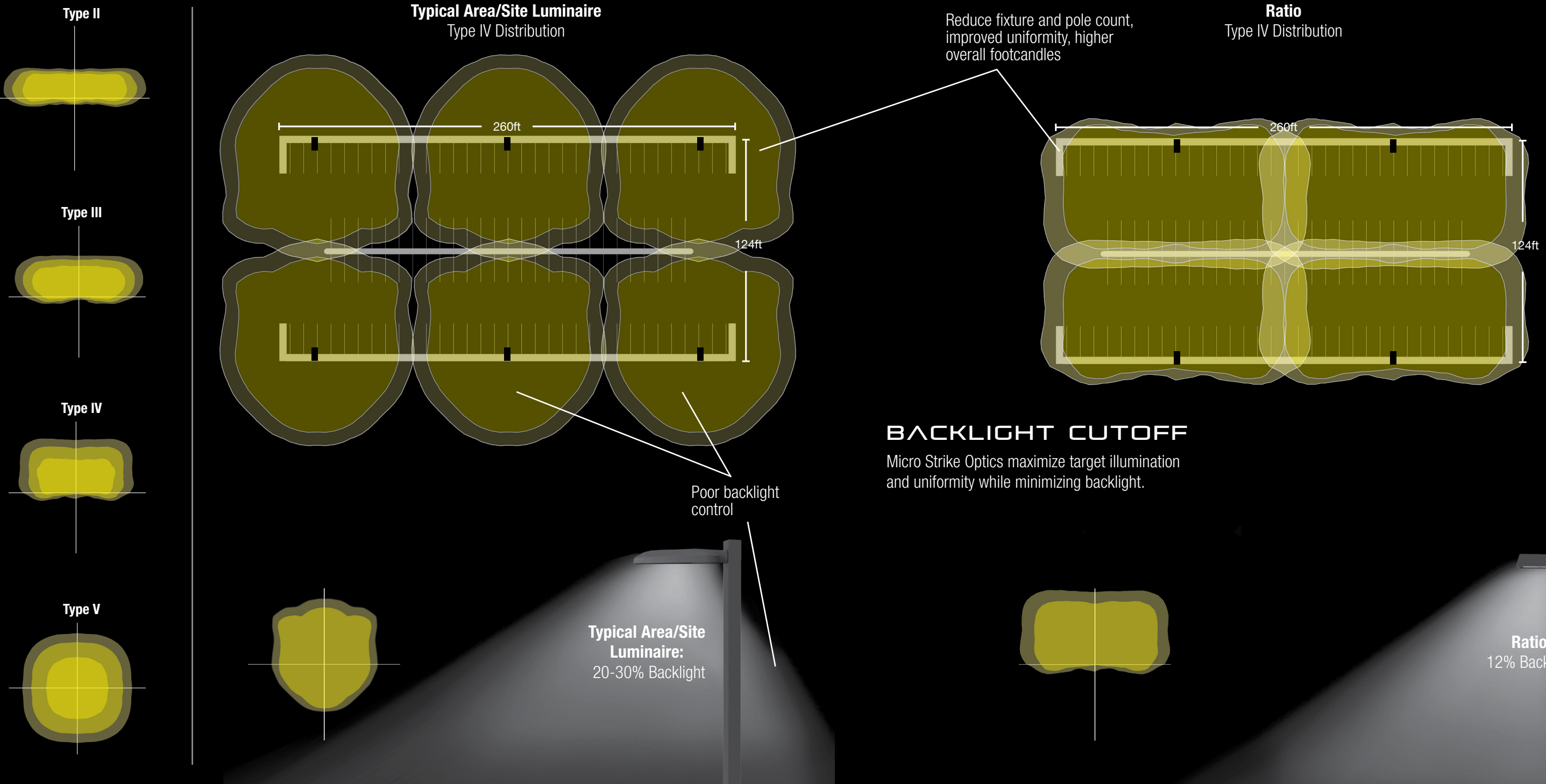



# RATIO FLOOD

Hubbell Outdoor Lighting's Ratio flood series is available in five sizes as well as a variety of outputs allowing you to customize your lighting design to meet application requirements.

The Ratio flood series was designed in cohesion with the site/area products to provide a sleek yet timeless product family to be used throughout a site. Ratio features a dense optical array which provides reduced pixelation and increased visual comfort without compromising performance.

Designed for sustained, long-term performance with advanced thermal management and elegantly simple heat sink and industry leading surge protection. Scalable sizes, multiple beam spreads and interchangeable mountings make this an extremely versatile product family.



RFL1 ultra-compact the size of a hand.

## VERSATILE FAMILY

From the ultra-compact RFL1 to the large RFL5, the Ratio family of floods provides lighting solutions for every flood lighting application large or small.



Visor  
RFL4 – RFL5

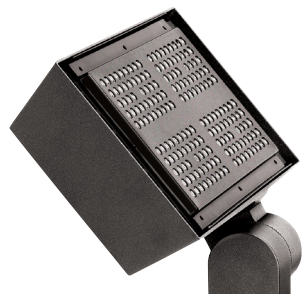

Louver  
RFL4 – RFL5



Trunnion Mount  
RFL4 – RFL5

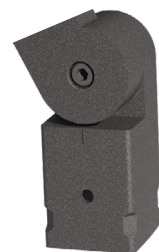

Knuckle Mount  
RFL4 – RFL5



Knuckle Mount  
RFL1 – RFL3



Trunnion Mount  
RFL1 – RFL3



Size	RFL1	RFL2	RFL3	RFL4	RFL5
Lumens	1,500	3,500	5,000/7,000	12,000/15,000	18,000/25,000/30,000
Watts	12.5W	25W	40/50W	95/120W	130/190/265W
LPW	120	130	125/140	125/130	125/130/115
Mounting	Knuckle	Knuckle, Trunnion	Knuckle, Trunnion	Knuckle, Trunnion	Knuckle, Trunnion
CCT	3K, 4K	3K, 4K, 5K	3K, 4K, 5K	3K, 4K, 5K	3K, 4K, 5K
Distributions	W	N, M, W	N, M, W	N, M, W	N, M, W
IP Rating	IP66	IP66	IP66	IP66	IP66
Legacy Equivalence	42W	100-150W	175-250W	250-400W	750W-1000W



# RATIO FLOOD - PERFORMANCE

## IES DISTRIBUTIONS

The Ratio flood series is available in three NEMA distribution patterns utilizing Micro Strike Optics for optimal performance.

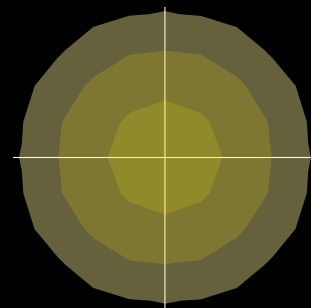

NEMA 6X6

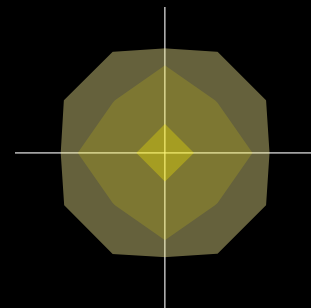

NEMA 4X4

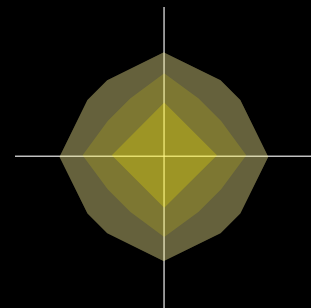

NEMA 2X2

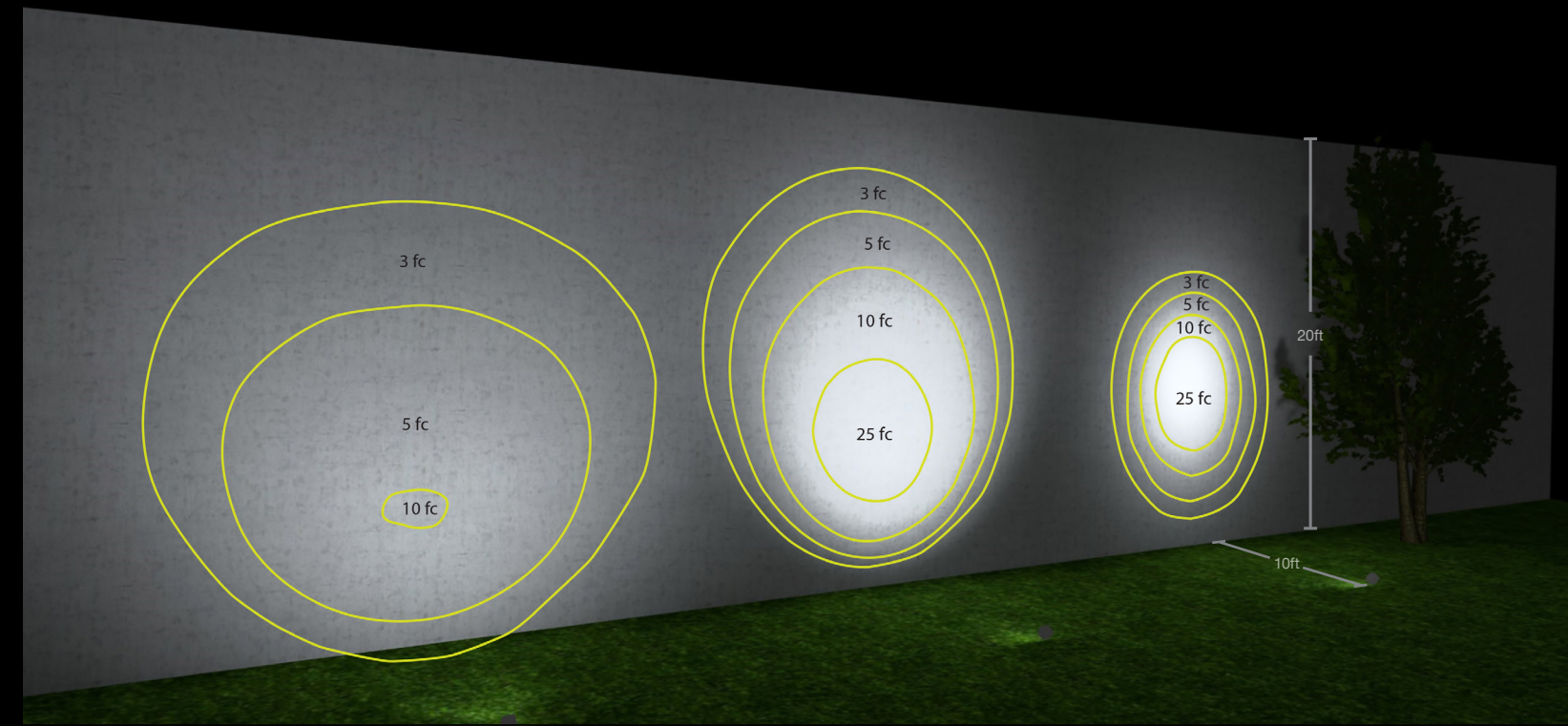

## SUPERIOR DESIGN

The Ratio flood series was specifically designed to shed water. The vented housing, in addition to cooling the fixture, also eliminates the ability for water to build up anywhere on the luminaire surface.

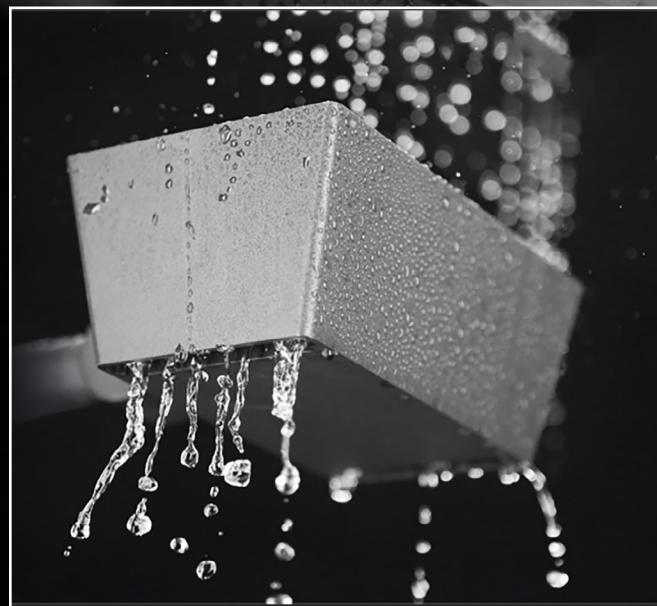

## OPTICAL EXCELLENCE

All optical geometry is on the inside of the lens creating a smooth finish that limits debris build up on the external surface. The lens also has no external hardware allowing for even pressure on the gasket preventing water intrusion.

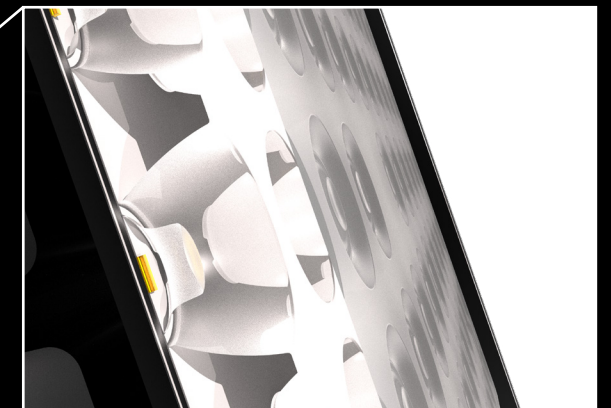
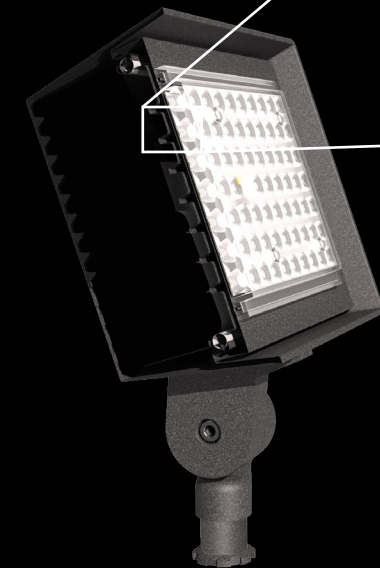



# RATIO COMPREHENSIVE SOLUTIONS

Hubbell Outdoor Lighting provides comprehensive and coordinated solutions for a variety of exterior applications. A full line of luminaires are available with complementing shapes and styles that proportionally scale and add balance to the outdoor environment. Quality construction and industry leading performance complete the package. Control options featuring photocontrols, occupancy controls and NX Distributed Intelligence™ enable optimum energy savings and customization.



AREA/SITE



FLOOD



WALL



CANOOPY



RATIO

GEOPAK™

LUMA  
SQUARE



# RATIO VISUAL COMFORT

Ratio's unique optical design combines visual uniformity with the precise distribution of a TIR optic. Five times the luminous surface area provides optimal light distribution plus visual comfort.

**Competitor Optic (COB)**



**Micro Strike Optics**



	Competitor Optic (COB)	Micro Strike Optics
Approximate Luminous Surface Area	10in <sup>2</sup>	50in <sup>2</sup>
Approximate Total Lumen Output	10,000	10,000
Lumens per inch <sup>2</sup>	1,000	200

**Lumasquare™**

A specially designed acrylic lens provides blended, non-pixelated illumination for unprecedented visual comfort.

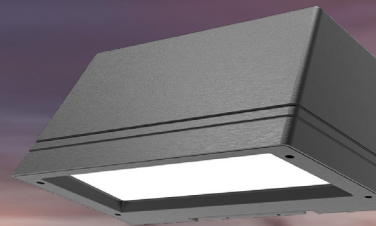

**GeoPak™**

Designed for optimal visual comfort and maximum performance, the low glare versions provide excellent illumination and uniformity with zero LED pixelation.



# RATIO INTEGRATED CONTROLS

Controls in area/site applications save energy, extend luminaire life and allow customizable solutions. Sensors control light output based on area utilization and are used for energy savings and local code compliance.



## STANDALONE CONTROLS FUNCTIONALITY

### Occupancy Sensor

- Individual fixture control
- Dims product when space is not occupied



### Photocontrol

- Individual fixture control
- Turns fixture on when sun sets



## INTEGRATED CONTROLS

### NX DISTRIBUTED INTELLIGENCE

Hubbell Controls Solutions' NX Distributed Intelligence™ platform delivers a lighting control solution capable of seamlessly connecting exterior and interior applications.

- Standalone or networked fixture control
- Astronomical time schedules
- BACnet building networking
- Connects with indoor wired, wireless or hybrid networks
- Wireless setup via app
- Occupancy Sensor option dims product when space is not occupied



### 7-Pin Receptacle

- Compatible with 3-pin, 5-pin or 7-pin photocontrols
- Turns fixture on when sun sets, off when sun rises
- Wireless networked solution
- For use with a variety of control platforms

\*Additional accessories required.





# RATIO AREA/SITE ORDERING INFORMATION

## STOCK ORDERING INFORMATION ORDERING EXAMPLE: RFL1-100-4K-4

CATALOG DESCRIPTION	LUMENS	WATTAGE	LED COUNT	CCT/CRI	VOLTAGE	DISTRIBUTION	MOUNTING	FINISH
RAR1-100-4K-3	12,000	100W	160L	4000K/70CRI	120-277V	Type IV Wide	Square Arm	Bronze
RAR1-100-4K-4	12,000	100W	160L	4000K/70CRI	120-277V	Type IV Wide	Square Arm	Bronze
RAR2-120-4K-3	18,000	140W	320L	4000K/70CRI	120-277V	Type IV Wide	Square Arm	Bronze
RAR2-120-4K-4	18,000	140W	320L	4000K/70CRI	120-277V	Type IV Wide	Square Arm	Bronze
RAR2-165-4K-3	21,000	165W	320L	4000K/70CRI	120-277V	Type IV Wide	Square Arm	Bronze
RAR2-165-4K-4	21,000	165W	320L	4000K/70CRI	120-277V	Type IV Wide	Square Arm	Bronze

## ORDERING INFORMATION ORDERING EXAMPLE: RFL2-80L-3K7-FR-UNV-ASQ-BL-NXWE-BC

SERIES	# LEDES	WATTAGE	CCT/CRI	DISTRIBUTION	OPTICS ROTATION	VOLTAGE	MOUNTING SQUARE POLES
RAR1 Ratio Area Size 1	80L-25	80 LEDs - 25w	3K7 3000K, 70 CRI	2 IES TYPE II	Blank for no rotation	UNV Universal 120-277V	ASQ Arm mount for square pole/flat surface
	80L-50	80 LEDs - 50w	4K7 4000K, 70 CRI	3 IES TYPE III	L Optic rotation left	347 347V	ASQU Universal Arm mount for square pole/flat surface
RAR2 Ratio Area Size 2	160L-70	160 LEDs - 70w	5K7 5000K, 70 CRI	4W IES TYPE IV	R Optic rotation right	480 480V	MOUNTING ROUND POLES
	160L-100	160 LEDs - 100w		5QW TYPE V			A_1 Arm mount for round pole
	320L-110	320 LEDs - 110w					A_U1 Universal arm mount for round point
	320L-140	320 LEDs - 140w					MOUNTING OTHER
	320L-165	320 LEDs - 165w					WB Wall bracket
	480L-185	480 LEDs - 185w					MAF Mast Arm Fitter for 2-3/8" OD horizontal arm
480L-210	480 LEDs - 210w					K Knuckle	
480L-240	480 LEDs - 240w						

### Ordering logic (CONT'D)

COLOR	CONTROL OPTIONS NETWORK	OPTIONS
BL Black	NXWE NX Wireless Enabled (module + radio)	F Fusing
DB Dark Bronze	NXSPW_F <sup>2</sup> NX Wireless, PIR Occ. Sensor, Daylight Harvesting	TB Terminal Block
GT Graphite	NXSP_F <sup>2</sup> NX, PIR Occ. Sensor, Daylight Harvesting	2PF 2 power feed with 2 drivers
GYS Gray Smooth	CONTROL OPTIONS OTHER	
PS Platinum Silver	SCP_F <sup>3</sup> Programmable occupancy sensor	
WH White	7PR 7-Pin twist lock receptacle	
CC Custom Color	7PR-SC 7-Pin receptacle with shorting cap	
	7PR-MD_F <sup>3</sup> Low voltage sensor for 7PR	
	7PR-TL 7-Pin PCR with photocontrol	

<sup>1</sup> Replace "\_" with "3" for 3.5"-4.13" OD pole, "4" for 4.18"-5.25" OD pole, "5" for 5.5"-6.5" OD pole  
<sup>2</sup> Replace "\_" with "14" for up to 14' mounting height, "30F" for 15-30' mounting height  
<sup>3</sup> Replace "\_" with "8" for up to 8' mounting height, "40F" for 9-40' mounting height

## DIMENSIONS

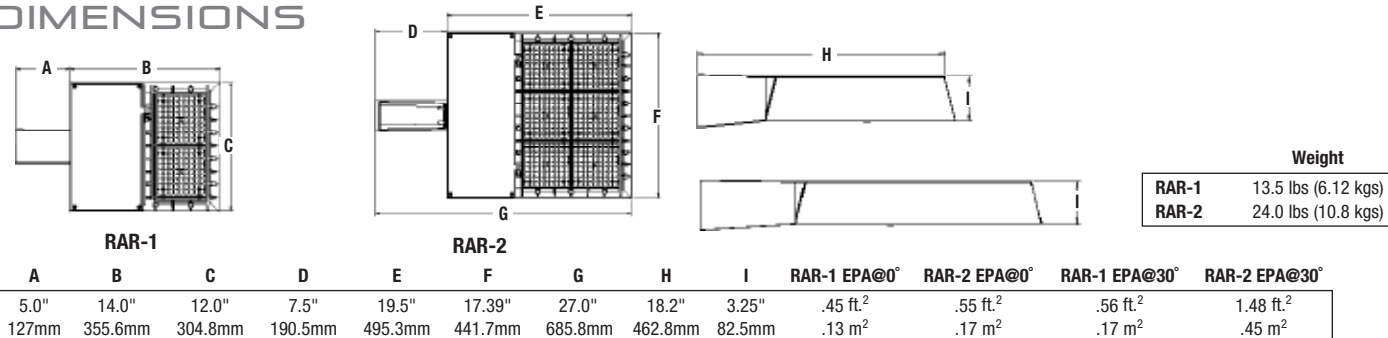

## STOCK ACCESSORIES/REPLACEMENT PARTS - Order Separately

Catalog Number	Description
<input type="checkbox"/> RARRPA3DB	Round pole adapter 3.5" TO 4.13"
<input type="checkbox"/> RARA3UDB	Universal mount for square pole or round pole 3.5" to 4.13"

## ACCESSORIES/REPLACEMENT PARTS - Order Separately

Catalog Number	Description
<input type="checkbox"/> RAR-ASQU-XX	Universal arm mount for square pole/flat surface
<input type="checkbox"/> RAR-A_U-XX	Universal arm mount for round poles
<input type="checkbox"/> RAR-RPA_XX	Round pole adapter
<input type="checkbox"/> TPLBARA3	Twin parallel luminaire bracket
<input type="checkbox"/> SETAVP	4" square pole top tenon adapter, 2 3/8" OD slipfitter
<input type="checkbox"/> RETAVP	4" round pole top tenon adapter; 2 3/8" OD slipfitter for max. Four fixtures (90°); order 4" round pole adapters separately
<input type="checkbox"/> TETAVP	Three-sided pole top tenon adapter, 2 3/8" OD slipfitter
<input type="checkbox"/> SPIKE	Bird Deterrent
<input type="checkbox"/> RARWB-XX	Wall Bracket - use with Mast Arm Fitter

<sup>1</sup> Replace "\_" with "3" for 3.5"-4.13" OD pole, "4" for 4.18"-5.25" OD pole, "5" for 5.5"-6.5" OD pole

## CONTROLS ACCESSORIES - Order Separately

Catalog Number	Description
<input type="checkbox"/> SW7PR	SiteSync™ on fixture module via 7PR
<input type="checkbox"/> SWUSB	SiteSync™ Software on USB
<input type="checkbox"/> SWTAB	SiteSync™ Windows Tablet
<input type="checkbox"/> SWBRG	SiteSync™ Wireless Bridge Node
<input type="checkbox"/> SWFC	SiteSync™ Field Commission Service
<input type="checkbox"/> SCPREMOTE	Order at least one per project location to program and control wiSCAPE™ external control node; use with 7PR
<input type="checkbox"/> WIR-RME-L	WX external control node; use with 7PR
<input type="checkbox"/> NXOFM-1R1D-UNV	NX external control node; use with 7PR

## MOUNTING

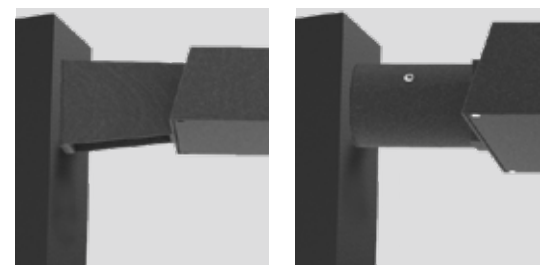

**Arm Mount** – Fixture ships with integral arm for ease of installation. Compatible with Hubbell Outdoor B3 drill pattern.

**MAF** – Fits 2-3/8" OD arms Roadway applications.

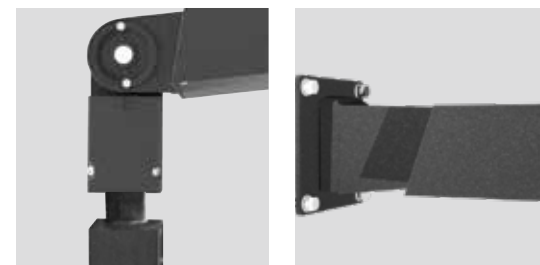

**Knuckle** – Knuckle mount 15° aiming angle increments for precise aiming and control, fits 2-3/8" tenons or pipes.

**Wall Mount** – Wall mount bracket designed for building mount applications.

## UNIVERSAL MOUNTING BLOCK

Universal mounting block for ease of installation. Compatible with drill patterns from 2.5" to 4.5"

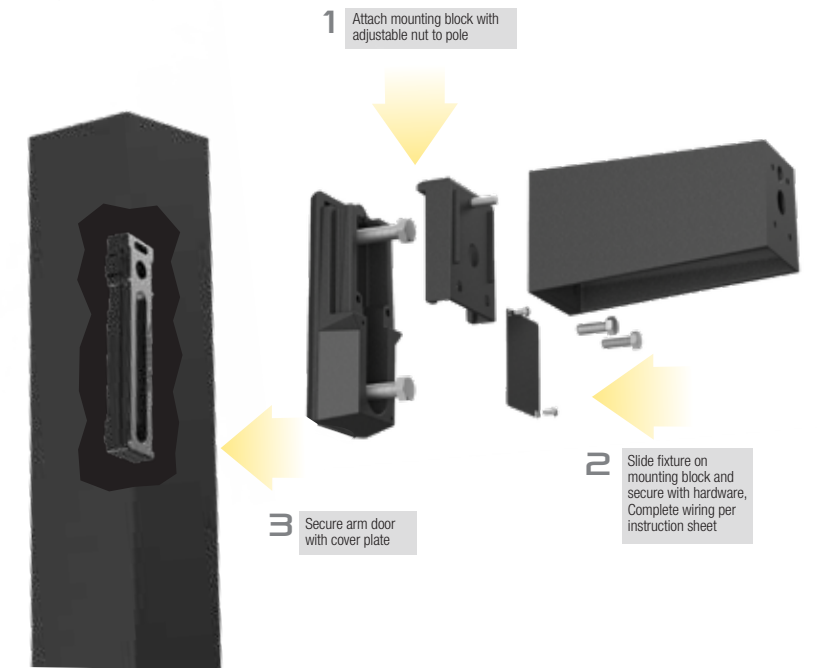

## FINISH OPTIONS

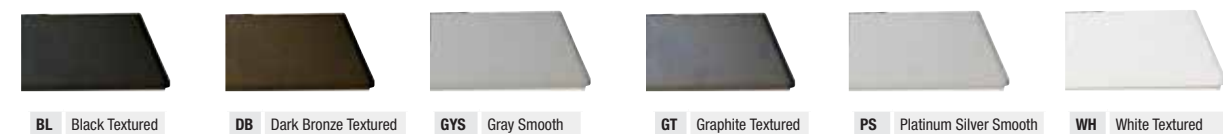



# RATIO FLOOD ORDERING INFORMATION

## STOCK ORDERING INFORMATION

CATALOG DESCRIPTION	MOUNTING	DISTRIBUTION	WATTAGE	VOLTAGE	CCT	LUMENS	WEIGHT LBS. (KG)	FINISH
RFL1-3K	Knuckle	Wide	15W	120-277V	3000K	1,500	1.25 (.57)	Bronze
RFL1-4K	Knuckle	Wide	15W	120-277V	4000K	1,500	1.25 (.57)	Bronze

## STOCK ORDERING INFORMATION

CATALOG DESCRIPTION	MOUNTING	DISTRIBUTION	WATTAGE	VOLTAGE	CCT	LUMENS	LPW	WEIGHT LBS. (KG)	FINISH
RFL2-25-4K	Knuckle	Wide	26	120-277V	4000K	3267	126	3.7 (1.68)	Bronze
RFL2-25-5K	Knuckle	Wide	26	120-277V	5000K	3283	126	3.7 (1.68)	Bronze
RFL3-40-4K	Knuckle	Wide	34	120-277V	4000K	4804	141	5.5 (2.5)	Bronze
RFL3-40-5K	Knuckle	Wide	34	120-277V	5000K	4827	142	5.5 (2.5)	Bronze
RFL3-50-4K*	Knuckle	Wide	50	120-277V	4000K	6823	132	5.5 (2.5)	Bronze
RFL3-50-5K*	Knuckle	Wide	50	120-277V	5000K	6655	129	5.5 (2.5)	Bronze

\*Also available with photocontrol

## ORDERING INFORMATION ORDERING EXAMPLE: RFL2-44-25-4K7-M-UNV-K-DB

Ordering logic

SERIES	# LEDS	WATTS	CCT/CRI	DISTRIBUTION	VOLTAGE	MOUNTING	COLOR	CONTROL OPTIONS
RFL2 Ratio Flood Size 2	44 44 LEDS	25 3,000 lm	3K7 3000K, 70 CRI	N Narrow, 2x2	UNV Universal 120-277	K Knuckle	BL Black	CD Continuous Dimmable
			4K7 4000K, 70 CRI	M Medium Flood, 4x4			DB Dark Bronze	PC Button Photocontrol
			5K7 5000K, 70 CRI	W Wide Flood, 6x6			GT Graphite	
							GY Gray Smooth	
							PS Platinum Silver	
							WH White	

## ACCESSORIES/REPLACEMENT PARTS - Order Separately

Catalog Number	Description
<input type="checkbox"/> S-302	Slipfits 1 1/2" or 2" pipe (1.9" OD or 2 3/8" OD) with 1/2" N.P.S.M. hub; Gray
<input type="checkbox"/> S-302-M51	Slipfits 1 1/2" or 2" pipe (1.9" OD or 2 3/8" OD) with 1/2" N.P.S.M. hub; Bronze
<input type="checkbox"/> S-302-M52	Slipfits 1 1/2" or 2" pipe (1.9" OD or 2 3/8" OD) with 1/2" N.P.S.M. hub; White
<input type="checkbox"/> TRN-XX	Trunnion adapter for 1/2" threaded knuckle mount

<sup>1</sup>Specify finish color to match fixture, e.g. DB - Bronze.

## DIMENSIONS

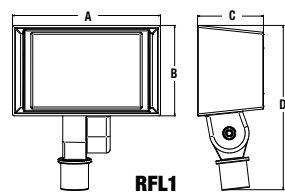

A	B	C	D
4.5"	2.7"	2.0"	5.0"
114 mm	69 mm	51 mm	127 mm

Weight
RFL1 1.25 lbs (0.57 kgs)

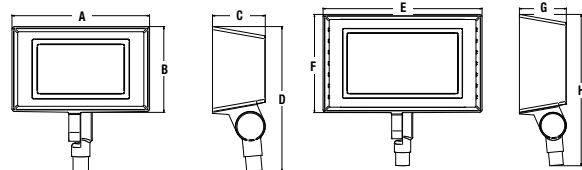

A	B	C	D	E	Weight
7.5"	4.7"	2.9"	7.9"	9.8"	RFL2 3.7 lbs (1.68 kgs)
191mm	119mm	74mm	201mm	249mm	RFL3 5.5 lbs (2.50 kgs)

F	G	H	RFL2 EPA(Front/Side)	RFL3 EPA(Front/Side)
6.0"	2.9"	9.3"	0.34ft <sup>2</sup> / 0.17ft <sup>2</sup>	0.97ft <sup>2</sup> / 0.20ft <sup>2</sup>
152mm	74mm	236mm		

## STOCK ORDERING INFORMATION

CATALOG DESCRIPTION	MOUNTING	DISTRIBUTION	WATTAGE	VOLTAGE	CCT	LUMENS	LPW	WEIGHT LBS. (KG)	FINISH
RFL4-120-5K-K	Knuckle	Wide	124W	120-277V	5000K	14432	116	16.0 (7.26)	Bronze
RFL4-120-4K-K	Knuckle	Wide	124W	120-277V	4000K	14360	116	16.0 (7.26)	Bronze
RFL5-265-5K-K	Knuckle	Wide	266W	120-277V	5000K	30649	115	25.7 (11.66)	Bronze
RFL5-265-4K-K	Knuckle	Wide	266W	120-277V	4000K	30496	115	25.7 (11.66)	Bronze

TRN-RFL - Trunnion Kit

\*\*Also available with Trunnion

## ORDERING INFORMATION ORDERING EXAMPLE: RFL4-176-95-4KL-M-UNV-K-GYS

Ordering logic

SERIES	# LEDS	WATTS	CCT/CRI	DISTRIBUTION	VOLTAGE	MOUNTING	COLOR
RFL4 Ratio Flood Size 4	176 176 LEDS	95 12,000 lm	3K7 3000K, 70 CRI	N Narrow, 2x2	UNV Universal 120-277	K Knuckle	BL Black
		120 15,000 lm	4K7 4000K, 70 CRI	M Medium Flood, 4x4	120 120V	T Trunnion	DB Dark Bronze
			5K7 5000K, 70 CRI	W Wide Flood, 6x6	208 208V		GT Graphite
					240 240V		GY Gray
					277 277V		PS Smooth
					347 347V		PL Platinum
					480 480V		WH Silver

Ordering logic (CONT'D)

## CONTROL OPTIONS

NXWE	NX Wireless Enabled (module + radio)
NXSPW_F <sup>1</sup>	NX Wireless, PIR Occ. Sensor, Daylight Harvesting
NXSP_F <sup>2</sup>	NX, PIR Occ. Sensor, Daylight Harvesting

## OPTIONS

SP	Surge Protector
F	Fusing
PCL	Polycarbonate Lens

## CONTROL OPTIONS OTHER

SCP_F <sup>2</sup>	Programmable occupancy sensor
7PR	7-Pin twist lock receptacle
7PR-SC	7-Pin receptacle with shorting cap
7PR-MD_F <sup>2</sup>	Low voltage sensor for 7PR
7PR-TL	7-Pin PCR with photocontrol

<sup>1</sup> Replace " " with "14" for up to 14' mounting height, "30F" for 15-30' mounting height  
<sup>2</sup> Replace " " with "8" for up to 8' mounting height, "40F" for 9-40' mounting height

See specification sheet for complete ordering information.

## ACCESSORIES/REPLACEMENT PARTS - Order Separately

Catalog Number	Description
<input type="checkbox"/> RFL4-TV	Top Visor - RFL4
<input type="checkbox"/> RFL4-FL	Louver - RFL4
<input type="checkbox"/> RFL5-TV	Top Visor - RFL5
<input type="checkbox"/> RFL5-FL	Louver - RFL5

See [www.HubbellLighting.com](http://www.HubbellLighting.com) for mounting bracket information.

## DIMENSIONS

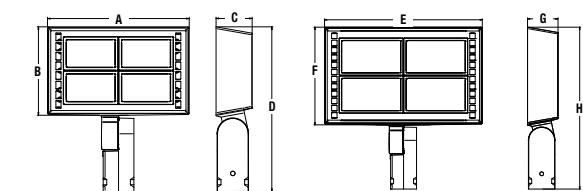

A	B	C	D	E	Weight
13.8"	8.6"	3.5"	16.0"	18.1"	RFL4 16 lbs (7.26 kgs)
351mm	218mm	89mm	406mm	460mm	RFL5 25.7 lbs (11.66 kgs)

F	G	H	RFL4 EPA(Front/Side)	RFL5 EPA(Front/Side)
11.2"	3.5"	18.6"	1.24ft <sup>2</sup> / 0.43ft <sup>2</sup>	2.00ft <sup>2</sup> / 0.50ft <sup>2</sup>
152mm	89mm	472mm		





**HUBBELL**  
Lighting

ALERA LIGHTING

ARCHITECTURAL AREA LIGHTING

BEACON PRODUCTS

COLUMBIA LIGHTING

COMPASS

DUAL-LITE

HUBBELL CONTROL SOLUTIONS

HUBBELL INDUSTRIAL LIGHTING

HUBBELL OUTDOOR LIGHTING

KIM LIGHTING

KURT VERSEN

LITECONTROL

PRESCOLITE



**HUBBELL**  
Outdoor Lighting

701 Millennium Blvd. Greenville, SC 29607  
Tel 864.678.1000  
[www.hubbelloutdoor.com](http://www.hubbelloutdoor.com)

HOL00339 5K April 11, 2019 10:22 AM

Copyright © 2019 Hubbell Outdoor Lighting, a division of Hubbell Lighting, Inc. All rights reserved.  
Please refer to online specifications for most up-to-date content as specifications are subject to change without notice.  
Due to our continued efforts to improve our products, product specifications are subject to change without notice.