

DIGITAL NAVIGATION

Ordering Tree nLight Platform Sensor Switch JOT Photometrics Performance Data

FEATURES & SPECIFICATIONS

INTENDED USE — The BLWP LED Wrap/ Wall bracket expands the BLT family with the features and aesthetics of the popular BLT and BLTR center basket design with a clean, versatile style and volumetric distribution. High efficacy LED light engines deliver energy savings and low maintenance compared to traditional sources. An extensive selection of configurations and options make the BLWP the perfect choice for many lighting applications including schools, offices, stairwells and other commercial spaces. With multiple mounting options, easy installation, and controls configurations, the BLWP is an excellent choice for renovation and new construction.

CONSTRUCTION — BLWP enclosure components are die-formed for dimensional consistency. For 2' and 4' product, hinged door frame allows easy access to electrical components and mounting locations without having to remove additional parts. For 8' product, suspension aircraft cables allow easy access to electrical components and mounting locations without having to remove additional parts. Available in three paint finishes: white (pre-paint), painted after fabrication white, and natural aluminum. Diffusers are extruded from impact modified acrylic for increased durability. Optional polycarbonate lens available for additional impact resistance, as well as Tamper Proof screws.

OPTICS — Volumetric illumination is achieved by creating an optimal mix of light to walls, partitions and vertical and horizontal work surfaces – rendering the interior space, objects and occupants in a more balanced, complimentary luminous environment. High performance extruded acrylic diffusers conceal LEDs and efficiently deliver light in a volumetric distribution. Five diffuser choices available - curved and square designs with ribbed, a smooth frosted finish, and a smooth polycarbonate finish.

ELECTRICAL — Long-life LEDs, coupled with high-efficiency drivers, provide superior quantity and quality of illumination for extended service life. 80% LED lumen maintenance at 60,000 hours (L80/60,000). Replaces 2 lamp fluorescent.

Configurable BLWP: Available in High Efficiency (HE) versions for applications where a lower wattage (over the standard product) is required. The High Efficiency versions deliver >130 LPW and can be specified via the Lumen Package designations in the Ordering Information on page 2.

eldoLED driver options deliver choice of dimming range, and choices for control, while assuring flicker-free, low-current inrush, 89% efficiency and low EMI.

Optional integrated nLight® controls make each luminaire addressable - allowing it to digitally communicate with other nLight enabled controls such as dimmers, switches, occupancy sensors and photocontrols. Connection to nLight is simple. It can be accomplished with integrated nLight AIR wireless or through standard Cat-5 cabling. nLight offers unique plug-and-play convenience as devices and luminaires automatically discover each other and self-commission, while nLight AIR is commissioned easily through an intuitive mobile app.

Lumen Management: Unique lumen management system (option N80) provides on board intelligence that actively manages the LED light source so that constant lumen output is maintained over the system life, preventing the energy waste created by the traditional practice of over-lighting.

Driver disconnect provided where required to comply with US and Canadian codes.

CONTROLS — **Integrated sensor (individual control):** Sensor Switch MSD7ADCX (Passive infrared (PIR)) or MSDPDT7ADCX (PIR/Microphonics Dual Tech (PDT) and Photocell (ADCX)) integrated occupancy sensor/automatic dimming photocell allows the luminaire to power off when the space is unoccupied or enough ambient light is entering the space.

Integrated Sensor (nLight Wired Networking): This sensor is nLight-enabled, meaning it has the ability to communicate over an nLight network. When wired, using CAT-5 cabling, with other nLight-enabled sensors, power packs, or WallPods, an nLight control zone is created. Once linked to an Eclipse, directly or via a Bridge, the zone becomes capable of remote status monitoring and control via SensorView software. See page 5 for the nLight sensor options.

Integrated Smart Sensor (nLight AIR Wireless Platform): The rE57 sensor is nLight AIR enabled, meaning it has the ability to communicate over the wireless nLight control platform. It is available with an automatic dimming photocell, and either a digital PIR or dual technology occupancy sensor. It pairs to other luminaires and wall switches through our mobile app, CLAIRITY+, which allows for simple sensor adjustment. See page 5 for more details on the Integrated Smart Sensor.

Integrated Wireless Sensor (single room control): Sensor Switch VERTEX JOT or JOTVTX15 luminaire-embedded occupancy and ambient light sensor allows the luminaire to power off when the space is unoccupied or when enough ambient light is entering the space. See page X for more details on the integrated wireless sensor.

INSTALLATION — Intended for surface or suspend mounting. For row mounting and quick mounting to junction boxes see accessories section. Suitable for damp location.

LISTINGS — CSA Certified to meet U.S. and Canadian standards.

DesignLights Consortium® (DLC) Premium qualified product and DLC qualified product. Not all versions of this product may be DLC Premium qualified or DLC qualified. Please check the DLC Qualified Products List at www.designlights.org/QPL to confirm which versions are qualified.

GOVERNMENT PROCUREMENT — BAA – Product with the BAA option qualifies as a domestic end product under the Buy American Act as implemented in the FAR and DFARS. Product with the BAA option also qualifies as manufactured in the United States under DOT Buy America regulations. BABA – Build America Buy America: Product with the BAA option also qualifies as produced in the United States under the definitions of the Build America, Buy America Act. Please refer to www.acuitybrands.com/buy-american for additional information.

WARRANTY — 5-year limited warranty. This is the only warranty provided and no other statements in this specification sheet create any warranty of any kind. All other express and implied warranties are disclaimed. Complete warranty terms located at: www.acuitybrands.com/support/warranty/terms-and-conditions

Note: Actual performance may differ as a result of end-user environment and application. All values are design or typical values, measured under laboratory conditions at 25 °C. Specifications subject to change without notice.

Catalog Number
Notes
Type

Low Profile LED Wraparound

BLWP

2', 4' and 8' Lengths



Specifications

2' Dimensions
 Length: 24 (60.96)
 Width: 5.50 (13.97)
 Depth: 3.50 (8.89)

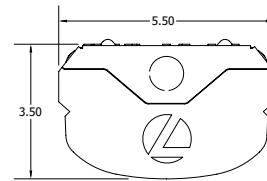

4' Dimensions
 Length: 48 (121.92)
 Width: 5.50 (13.97)
 Depth: 3.50 (8.89)

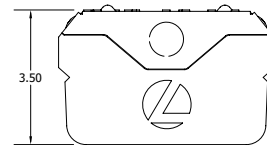

8' Dimensions
 Length: 96 (243.84)
 Width: 5.50 (13.97)
 Depth: 3.50 (8.89)

All dimensions are inches (centimeters) unless otherwise specified.

A+ Capable Luminaire

This item is an A+ capable luminaire, which has been designed and tested to provide consistent color appearance and out-of-the-box control compatibility with simple commissioning when used with Acuity Brands controls products.

All configurations of this luminaire are calibrated and tested to meet the Acuity Brands' specifications for chromatic consistency – including color rendering, color fidelity, and color temperature tolerance around standard CIE chromaticity coordinates.

To learn more about Acuity A+ standards, specifications, and testing visit www.acuitybrands.com/aplus.



Items marked by a shaded background qualify for the Design Select program and ship in 15 days or less. To learn more about Design Select, visit www.acuitybrands.com/designselect.

*See ordering tree for details

BLWP Low Profile LED Wraparound



Design Select options indicated by this color background.

ORDERING INFORMATION

Lead times will vary depending on options selected. Consult with your sales representative.

Example: BLWP4 40L ADP GZ10 LP840

Series	Lumens ‡	Lens/Diffuser	Voltage	Driver	Color Temperature	
BLWP2 2' LED Wraparound	Standard Efficiency (>100 LPW)	High Efficiency ‡ (>130 LPW)	(blank) MVOLT 120 120V 277 277V 347 347V ‡	EZ1 eLdoLED dims to 1% (0-10v dimming) GZ1 Generic dims to 1% (0-10v dimming) ‡ GZ10 Generic dims to 10% (0-10v dimming) ‡ SLD Step-level dimming ‡	LP830 82CRI, 3000K LP835 82CRI, 3500K LP840 82CRI, 4000K LP850 82CRI, 5000K LP930 90CRI, 3000K LP935 90CRI, 3500K LP940 90CRI, 4000K LP950 90CRI, 5000K	
	8L 800 Lumens	8LHE 800 Lumens				ADP Curved, ribbed
	20L 2000 Lumens	20LHE 2000 Lumens				ADSM Curved, smooth
	33L 3300 Lumens	33LHE 3300 Lumens				SDP Square, ribbed
	40L 4000 Lumens	40LHE 4000 Lumens				SDSM Square, smooth
	48L 4800 Lumens	48LHE 4800 Lumens				PDSM Curved, smooth polycarbonate ‡
						Diffusers w/ trim rings
						ADPT Curved, ribbed
BLWP4 4' LED Wraparound	15L 1500 Lumens	15LHE 1500 Lumens	ADSMT Curved, smooth			
	20L 2000 Lumens	20LHE 2000 Lumens	SDPT Square, ribbed			
	30L 3000 Lumens	30LHE 3000 Lumens	SDSMT Square, smooth			
	40L 4000 Lumens	40LHE 4000 Lumens	PDSMT Curved, smooth polycarbonate ‡			
	48L 4800 Lumens	48LHE 4800 Lumens				
	60L 6000 Lumens	60LHE 6000 Lumens				
	72L 7200 Lumens	72LHE 7200 Lumens				
	85L 8500 Lumens	85LHE 8500 Lumens				
	100L 10000 Lumens	100LHE 10000 Lumens				
BLWP8 8' LED Wraparound	40L 4000 Lumens	40LHE 4000 Lumens				
	60L 6000 Lumens	60LHE 6000 Lumens				
	80L 8000 Lumens	80LHE 8000 Lumens				
	100L 10000 Lumens	100LHE 10000 Lumens				
	140L 14000 Lumens	140LHE 14000 Lumens				
	180L 18000 Lumens	180LHE 18000 Lumens				
	200L 20000 Lumens	200LHE 20000 Lumens				

nLight Interface ‡	Control ‡	Individual Control
nLight Wired	nLight Wired	
(blank) no nLight® interface	(blank) no nLight control	
N80 nLight with 80% lumen management	NES7 nLight™ nES 7 PIR integral occupancy sensor ‡	MSD7ADCX PIR integral occupancy sensor with automatic dimming control photocell ‡
N80EMG nLight with 80% lumen management. For use with generator supply EM power ‡	NESPDT7 nLight™ nES PDT 7 dual technology integral occupancy control ‡	MSDPDT7ADCX PDT integral occupancy sensor with with automatic dimming control photocell ‡
N100 nLight without lumen management	NES7ADCX nLight™ nES 7 ADCX PIR integral occupancy sensor with automatic dimming photocell ‡	JOT Wireless room control with "Just One Touch" pairing ‡
N100EMG nLight without lumen management. For use with generator supply EM power ‡	NESPDT7ADCX nLight™ nES PDT 7 dual technology integral occupancy sensor with automatic dimming photocell ‡	JOTVTX15 Wireless occupancy sensor with "Just One Touch" pairing ‡
nLight Wireless	nLight Wireless	
(blank) no nLight® interface	(blank) no nLight control	
NLTAIR2 nLight AIR Generation 2 enabled ‡	RES7 nLight AIR control with PIR integral occupancy sensor and automatic dimming photocell ‡	
	RES7PDT nLight AIR control with PDT dual technology integral occupancy sensor and automatic dimming photocell ‡	
	RIO nLight AIR radio module without sensor ‡	
	RES7EM nLight AIR PIR integral occupancy sensor with automatic dimming photocell and UL924 Emergency Operation, via power interrupt detection ‡	
	RES7PDTEM nLight AIR microphonics dual technology occupancy sensor with automatic dimming photocell & UL924 Emergency Operation, via power interrupt detection ‡	
	RIOEM nLight AIR radio module less sensor, with UL924 Emergency Operation, via power interrupt detection ‡	

Standby mode ‡	Options	Finish
(blank) Fixture with embedded sensor turns off when unoccupied	E10WLCP EM Self-Diagnostic battery pack, 10W Constant Power, Certified in CA Title 20 MAEDBS	(blank) Standard pre-paint white
DIM10 Fixture with embedded sensor dims to approximately 10% light output when unoccupied ‡	EL7L 700 nominal lumens battery pack ‡	PAF Paint After Fabrication White
DIM50 Fixture with embedded sensor dims to approximately 50% light output when unoccupied ‡	EL14L 1400 nominal lumens battery pack ‡	DNA Paint After Fabrication Natural Aluminum
NOC Occupancy sensor disabled ‡	BGTD Bodine Generator Transfer Device ‡	
	QMB Quick Mount Bracket ‡	
	TRS Tamper Resistant Screw ‡	
	GLR Fast-blowing fuse ‡	
	GMF Slow-blowing fuse ‡	
	FAO Field Adjustable Output ‡	
	PLR1G Plug-in wiring, see page 10 for ordering information ‡	
	PLR2ABG	
	PLR2ANG	
	PLR1LVG Plug-in wiring, low voltage dimming ‡	
	BAA Buy America(n) Act and/or Build America Buy America Qualified	
	BDP Factory Installed Ballast Disconnect Plug	

NOTE: ‡ indicates option value has ordering restrictions. Please reference the Option Value Ordering Restrictions chart on the next page. Options are sorted alphanumerically.

See Accessories and footnotes on page 4.

BLWP Low Profile LED Wraparound

‡ Option Value Ordering Restrictions	
Option value	Restriction
347	Not available with E10WLCP, EL7L, EL14L, BGTD or BLWP4 > 85L/ 85LHE.
BLWP8CR, BLWP8CRDNA, BLWP8CR, BLWP8CRDNA	Cannot be used to continuous row mount 4' fixtures with 8' fixtures. 2' fixtures cannot be continuous row mounted.
BGTD	Not available with JOT sensor options or emergency battery options. Must specify voltage. Requires BSE labeling, voltage specific. Consult factory for options. Example: BGTD BSE10.
DIM10, DIM50	Not available with NLTAIR2 or JOT sensor option. Requires occupancy control. Must be ordered with nLight Wired or Individual Control sensor option.
EL7L, EL14L	Only available on BLWP8, 8ft length version of this fixture, in lumen packages 140L or less.
FAO	EZ1 driver required. Not available with BAA or lumen packages > 6000LM. FAO is not available with other integrated controls options and restricts the use of external dimming controls. See chart on page 5 for additional details.
GLR, GMF	Must specify voltage. 120 or 277, with GLR and GMF fusing.
GZ1, GZ10	Not available with any Control or Sensor options except JOT & JOTVTX15
JOT, JOTVTX15	Not available with SLD, NLIGHT, NLTAIR2, NOC, BAA or FAO. Available only on 4' versions with PDSM, PDSMT, ADPT and ADMST trim options; not available with <60L or 60LHE lumen packages.
Lumens	Approximate lumen output. For high efficiency, all versions may not achieve 130+ LPW including 90CRI and versions with integral sensor trim. Refer to photometry on www.acuitybrands.com. See QPL for latest DLC listings.
MSD7ADCX, MSPDPT7ADCX	Must select Lens/Diffuser type with Trim Rings. Not available with nLight interface. 0-10V wires are not accessible via access plate.
N80EMG, N100EMG	Requires a connection to existing nLight network. Power is provided from a separate NLIGHT enabled fixture or external power pack.
NES7, NESPDT7, NES7ADCX, NESPDT7ADCX	Must select Lens/Diffuser type with Trim Rings. Requires N80, N80EMG, N100, or N100EMG. Only available with EZ1 driver.
NLTAIR2	Must select nLight wireless control. Not available with JOT or JOTVTX15
NOC	Not available with JOT sensor options. Can only be ordered in conjunction with EZ1, NLTAIR2, RES7/RES7PDT. Occupancy sensor disabled at factory but can be re-enabled upon commissioning.
PDSM, PDSMT	Not available with HE (high efficiency) performance package on BLWP2 and BLWP4 only.
PLR1G, PLR2ABG, PLR2ANG, PLR1LVG	Not available with BLWP2. PLR1LVG is not available with Controls options or nLight interface. Not available with emergency options.
QMB	Not available with BLWP2 (2') or BLWP8 (8') fixture.
RES7EM, RES7PDTM, RIOEM	Must select Lens/Diffuser type with Trim Rings. Requires EZ1 and NLTAIR2 to be specified. Only available with 60L or lower lumen packages on the BLWP4. Only available with 100LHE/80L lumen packages or lower on the BLWP8.
RES7, RES7PDT, RIO	See UL924 Sequence of Operation chart on bottom of page 3. Must select Lens/Diffuser type with Trim Rings. Requires EZ1 and NLTAIR2 to be specified. Only available with 60L or lower lumen packages on the BLWP4. Only available with 100LHE/80L lumen packages or lower on the BLWP8.
SLD	Not available with any nLight Interface or Control options. Cannot be used with PLR1LVG. Not available for lumen packages 72L and higher.
TRS	Accessory BLWP TRS T15 BIT available to be ordered with this option. See Accessories section page 4. Order as separate item.

Non-Configurable BLWP:

MTO	CI code	Catalog Description	UPC	Lumens	Wattage	LPW	Color Temperature	Voltage	Pallet QTY
MTO	*264V2M	BLWP2 20L ADP LP835	191848282045	1942	17	117	3500 K	120-277	80
	*264V2L	BLWP2 20L ADP LP840	191848282038	1973	17	119	4000 K	120-277	80
	*264CH0	BLWP2 33L ADP LP835	191848080825	3332	30	112	3500 K	120-277	80
	*264CH1	BLWP2 33L ADP LP840	191848080832	3345	30	112	4000 K	120-277	80
	*264CH2	BLWP2 40L ADP LP835	191848080849	3923	37	105	3500 K	120-277	80
	*264CH4	BLWP2 40L ADP LP840	191848080856	4117	37	110	4000 K	120-277	80
	*264V2K	BLWP4 30L ADP LP835	191848282021	3065	25	123	3500 K	120-277	70
	*264V2H	BLWP4 30L ADP LP840	191848281994	3114	25	125	4000 K	120-277	70
	*264CH5	BLWP4 40L ADP LP835	191848080863	4391	35	127	3500 K	120-277	70
	*264CH6	BLWP4 40L ADP LP840	191848080870	4263	35	123	4000 K	120-277	70
	*264CH7	BLWP4 48L ADP LP835	191848080900	5137	40	129	3500 K	120-277	70
	*264CH8	BLWP4 48L ADP LP840	191848080917	5205	40	131	4000 K	120-277	70

UL924 Sequence of Operation
The below information applies to all nLight AIR devices with an EM option.
<ul style="list-style-type: none"> EM devices will remain at their high-end trim and ignore wireless lighting control commands, unless a normal-power-sensed (NPS) broadcast is received at least every 8 seconds. Using the CLAIRITY+ mobile app, EM devices must be associated with a group that includes a normal power sensing device to receive NPS broadcasts. Only non-emergency rPP20, rLSXR, rSBOR, rSDGR, and nLight AIR luminaires with version 3.4 or later firmware can provide normal power sensing for EM devices. See specification sheets for control devices and luminaires for more information on options that support normal power sensing.

BLWP Low Profile LED Wraparound

Accessories: Order as separate catalog number.				
PART number	CI CODE	QTY	Description	Application
BLWP8/4CR	*272PFG	1	CONTINUOUS ROW MOUNT BRACKET FOR ROW CONNECTING BLWP4 and BLWP8 WHT	FOR USE TO MOUNT BLWP8 TO BLWP4, FOR STD FINISH AND PAF
BLWPCR	*250A0S	1	CONTINUOUS ROW MOUNT BRACKET WHT	FOR USE ON BLWP4 ONLY, FOR STD FINISH AND PAF ‡
BLWPCRDNA	*250A1S	1	CONTINUOUS ROW MOUNT BRACKET DNA	FOR USE ON BLWP4 ONLY, FOR DNA FINISH ‡
BLWP8CR	*2543C6	1	CONTINUOUS ROW MOUNT BRACKET WHT	FOR USE ON BLWP8 ONLY, FOR STD FINISH AND PAF ‡
BLWP8CRDNA	*2543CA	1	CONTINUOUS ROW MOUNT BRACKET DNA	FOR USE ON BLWP8 ONLY, FOR DNA FINISH ‡
BLWPCG36 F1	*264R3P	1	BLWPCG36 F1	ADJUSTABLE AIRCRAFT CABLE GRIPPER KIT, 36 INCH F1 CEILING TYPE
BLWPCG36 F2	*264R4G	1	BLWPCG36 F2	CABLE GRIPPER KIT, 36 INCH F2 CEILING TYPE
BLWPCG72 F1	*264R4H	1	BLWPCG72 F1	CABLE GRIPPER KIT, 72 INCH F1 CEILING TYPE
BLWPCG72 F2	*264R4M	1	BLWPCG72 F2	CABLE GRIPPER KIT, 72 INCH F2 CEILING TYPE
BLWPCGF36 F1	*264R4R	1	BLWPCGF36 F1	KIT WITH POWER FEED 36 INCH F1 CEILING TYPE
BLWPCGF36 F2	*264R4U	1	BLWPCGF36 F2	KIT WITH POWER FEED 36 INCH F2 CEILING TYPE
BLWPCGF72 F1	*264R4V	1	BLWPCGF72 F1	KIT WITH POWER FEED 72 INCH F1 CEILING TYPE
BLWPCGF72 F2	*264R4X	1	BLWPCGF72 F2	KIT WITH POWER FEED 72 INCH F2 CEILING TYPE
BLWPCGE36 F1	*264R50	1	BLWPCGE36 F1	KIT WITH EMERGENCY POWER FEED 36 INCH F1 CEILING TYPE
BLWPCGE36 F2	*264R5T	1	BLWPCGE36 F2	KIT WITH EMERGENCY POWER FEED 36 INCH F2 CEILING TYPE
BLWPCGE72 F1	*264R5V	1	BLWPCGE72 F1	KIT WITH EMERGENCY POWER FEED 72 INCH F1 CEILING TYPE
BLWPCGE72 F2	*264R53	1	BLWPCGE72 F2	KIT WITH EMERGENCY POWER FEED 72 INCH F2 CEILING TYPE
BLWPCGFD36 F1	*269V4M	1	BLWPCGFD36 F1	KIT WITH 0-10V DIMMING POWER FEED 36 INCH F1 CEILING TYPE
BLWPCGFD36 F2	*269V5C	1	BLWPCGFD36 F2	KIT WITH 0-10V DIMMING POWER FEED 36 INCH F2 CEILING TYPE
BLWPCGFD72 F1	*269V5N	1	BLWPCGFD72 F1	KIT WITH 0-10V DIMMING POWER FEED 72 INCH F1 CEILING TYPE
BLWPCGFD72 F2	*269V5X	1	BLWPCGFD72 F2	KIT WITH 0-10V DIMMING POWER FEED 72 INCH F2 CEILING TYPE
BLWP TRS T15 BIT	*2516KU	1	BLWP TRS T15 BIT	T15 WITH PIN, TORX BIT FOR TRS OPTION
BLWPQMB	*250A2S	1	BLWP Quick Mount Bracket	QUICK MOUNT BRACKET FOR INSTALLATION TO JUNCTION BOXES WITHOUT HAVING TO REMOVE ANY PARTS IN THE FIXTURE, 4FT FIXTURE ONLY.
RK8BDP 2P U			Disconnect Plug (BDP), 2 Pole, Package of 1	
RK8BDP 3P U			Disconnect Plug (BDP), 3 Pole, Package of 1	
RK8BDP 2P J10			Disconnect Plug (BDP), 2 Pole, Package of 10	
RK8BDP 2P J40			Disconnect Plug (BDP), 2 Pole, Package of 40	
1B			Hanger spaces fixtures 1½" to 2½" from ceiling. Standard pack: J2, J20, J100	
SQ_			Complete assembly with stem up to 48" Specify stem length in 2" increments and adjust as needed. 5/8" O.D. stem. Swivels 30° from vertical in any direction. Example: SQ24	

nLight® Wired Control Accessories: Order as separate catalog number. Visit www.acuitybrands.com/products/controls/nlight .			
WallPod stations	Model number	Occupancy sensors	Model number
On/Off	nPODM [color]	Small motion 360°, ceiling (PIR / dual tech)	nCM 9 RJB / nCM PDT 9 RJB
On/Off & raise/lower	nPODM DX [color]	Large motion 360°, ceiling (PIR / dual tech)	nCM10 RJB / nCM PDT 10 RJB
Graphic touchscreen	nPOD GFX [color]	Wall switch with raise/lower	nWSX PDT LV DX [color]
Photocell controls	Model number	Cat-5 cable (plenum rated)	Model number
Full range dimming	nCM ADCX RJB	10' cable	CAT5 10FT J1
		30' cable	CAT5 30FT J1

nLight® AIR Control Accessories: Order as separate catalog number. Visit www.acuitybrands.com/products/controls/nlightair .	
Wall switches	Model number
On/Off single pole	rPODB [color] G2
On/Off two pole	rPODB 2P [color] G2
On/Off & raise/lower single pole	rPODB DX [color] G2
On/Off & raise/lower two pole	rPODB 2P DX [color] G2
On/Off & raise/lower single pole	rPODBZ DX WH G2

BLWP Low Profile LED Wraparound

Replacement Parts: Order as separate catalog number.					
2' Version Replacement Lens		4' Version Replacement Lens		8' Version Replacement Lens	
*264F5E	DBLWP24 ADP	*264F69	DBLWP48 ADP	*2543CE	DBLWP96 ADP
*264F5F	DBLWP24 SDP	*264F6E	DBLWP48 SDP	*2543CG	DBLWP96 SDP
*264F5H	DBLWP24 ADSM	*264F6F	DBLWP48 ADSM	*2543CJ	DBLWP96 ADSM
*264F5J	DBLWP24 SDSM	*264F6G	DBLWP48 SDSM	*2543CM	DBLWP96 SDSM
*264F5L	DBLWP24 ADPT	*264F6H	DBLWP48 ADPT	*2543CN	DBLWP96 ADPT
*264F5P	DBLWP24 SDPT	*264F6K	DBLWP48 SDPT	*2543CP	DBLWP96 SDPT
*264F5U	DBLWP24 ADSMT	*264F6L	DBLWP48 ADSMT	*2543CR	DBLWP96 ADSMT
*264F5W	DBLWP24 SDSMT	*264F6N	DBLWP48 SDSMT	*2543CS	DBLWP96 SDSMT
*264F66	DBLWP24 PDSM	*264F6W	DBLWP48 PDSM	*2543CW	DBLWP96 PDSM
*264F67	DBLWP24 PDSMT	*264F6X	DBLWP48 PDSMT	*2543CX	DBLWP96 PDSMT

FAO SETTINGS (Field Adjustable Output)

	0-10 Voltage Dimmer	% Lumen Output (approximate)	% Wattage (approximate)
Step 8	Full Output	100%	100%
Step 7	9.0 VDC	98%	100%
Step 6	8.0 VDC	88%	86%
Step 5	7.0 VDC	86%	82%
Step 4	6.0 VDC	82%	80%
Step 3	5.0 VDC	76%	75%
Step 2	4.0 VDC	71%	72%
Step 1	3.0 VDC	67%	71%

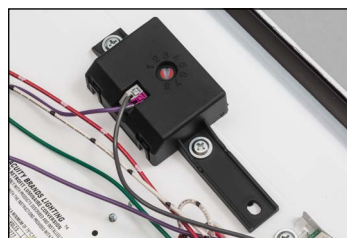

Simple adjustment of output through the use of a flat head screwdriver.

JOT Wireless



Sensor Switch JOT Enabled Wireless Solution

Designed with contractors in mind, the Sensor Switch JOT enabled wireless solution offers a straightforward approach to the installation and pairing of lighting fixtures and controls. Absolutely no 0-10V control wires and no mobile apps are needed with JOT enabled products, allowing for lightning speed installation right out of the box.

- 1. Power:** Install JOT enabled fixtures and controls as instructed.
- 2. Pair:** Insert the pairing tool into the pinhole on the wall switch; press and hold any button for 6 seconds.
- 3. Play:** Once paired, each fixture will individually dim down to 10% brightness. All products will be fully functional.

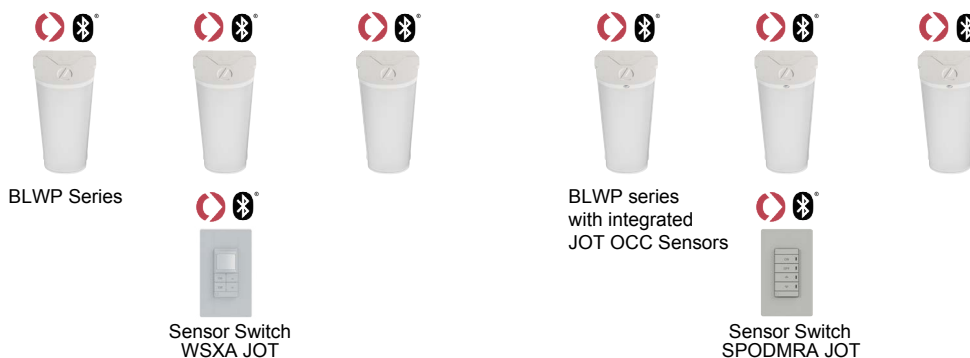

BLWP Low Profile LED Wraparound

nLight Platform

nLight embedded fixtures offer:	Customers get:
Manual Dimming	Convenience and visual comfort for occupants
Motion Sensing and/or Daylight Harvesting	Energy savings and code compliance
Fixture or Group Level Control	Ability to configure lighting to the space requirements
Flexibility	Ease of fixture moves, adds and changes
Wireless Wall Switch (nLight AIR Only)	Ease and flexibility of placement
Astronomical and Time of Day Scheduling	Energy savings and building security
Scalable Solution	nLight controls to grow with your business
Future-Ready	nLight platform to set foundation for future upgrades and capabilities

nLight Air Wireless



Simple as 1,2,3

1. Install the nLight® AIR fixtures with embedded smart sensor
2. Install the wireless battery-powered wall switch
3. With CLAIRITY+ app, pair the fixtures with the wall switch and if desired, customize the sensor settings for the desired outcome



nLight Wired Networking



Simple as 1,2,3

1. Install the nLight® Wired fixtures with embedded control
2. Install the nLight Wired wall switch
3. Connect the fixtures using standard CAT5e cables and the devices will automatically discover each other and work (plug and play)



BLWP Low Profile LED Wraparound

Sensor Options					
Option	Automatic Dimming Photocell	Occupancy Sensing		nLight Wired Networking	nLight AIR Networking
		PIR	PDT		
MSD7ADCX	X	X			
MSDPDT7ADCX	X		X		
NES7		X		X	
NES7ADCX	X	X		X	
NESPD7			X	X	
NESPD7ADCX	X		X	X	
RES7	X	X			X
RES7PDT	X	X	X		X

Integrated Sensor with Individual Control

The MSD7ADCX PIR occupancy sensor/automatic dimming photocell is ideal for areas without obstructions and where daylight harvesting may be desired. Suggested applications include, but not limited to, hallways, corridors, storage rooms, and breakrooms or other areas where people are typically moving.

The MSDPDT7ADCX PIR/Microphonics Dual Tech occupancy sensor/automatic dimming photocell is ideal for areas with obstructions and where daylight harvesting is desired. Suggested applications include, but not limited to, open offices, private offices, classrooms, public restrooms, and conference rooms.

Basic nLight Zone

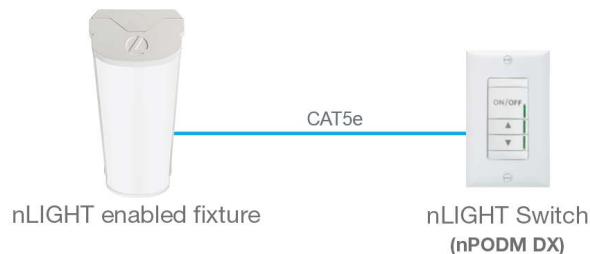

nLight Wired Networking

The nES 7 is ideal for small rooms without obstructions or areas with primarily walking motion. Ideal areas include hallways, corridors, storage rooms, and breakrooms. Additionally, the NES7ADCX includes an integrated photocell, which enables daylight harvesting controls.

For areas like restrooms, private offices, open offices, conference rooms or any space with obstructions, the nES PDT 7 dual technology sensor is recommended. The nES PDT 7 utilizes both PIR (passive infrared) and Microphonics technologies to detect occupancy. Additionally, the NESPD7ADCX includes an integrated photocell, which enables daylight harvesting controls which is ideal for areas where windows are present.

Sequence of Operation

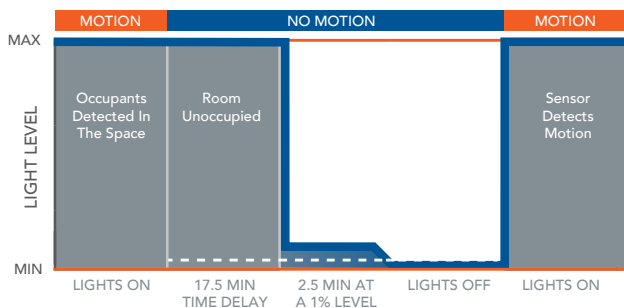

*The presetting on the automatic dimming photocell is 5fc.

Sequence of Operation

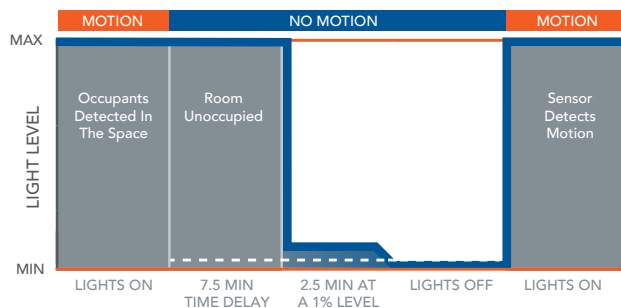

*The presetting on the automatic dimming photocell is 5fc.

Sensor Coverage Pattern Mini 360° Lens

- Recommended for walking motion detection from mounting heights between 8 ft (2.44 m) and 20 ft (6.10 m)
- Initial detection of walking motion along sensor axes at distances of 2x the mounting height up to 15 ft (4.57 m) and 1.75x up to 20 ft (6.10 m).
- Provides 12 ft (3.66 m) radial detection of small motion when mounted at 9 ft (2.74 m)
- Initial detection will occur earlier when walking across sensor's field of view than when walking directly at sensor

9 FT Mounting

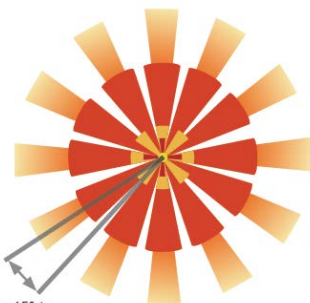

Lens rotates 15° to enable adjustment

5.5	18
4.6	15
3.7	12
2.7	9
1.8	6
0.9	3
0m	0ft
0.9	3
1.8	6
2.7	9
3.7	12
4.6	15
5.5	18



Simple as 1,2,3

1. Install the nLight® AIR fixtures with embedded smart sensor
2. Install the wireless battery-powered wall switch
3. With CLAIRITY+ app, pair the fixtures with the wall switch and if desired, customize the sensor settings for the desired outcome



MOUNTING INFORMATION

For unit or row installation; surface or suspend mounting.

Suspension Methods:

Aircraft Cable Suspension

Order one BLWPCG_, BLWPCGF_, or BLWPCGE_ required for each suspension point.
 F1 for use with most T-bar and screw slot grid ceiling applications. Designed for on-grid and off-grid installations.
 F2 for use with recessed or surface-mount horizontal J-box applications.
 See Accessories page on page 4 for part numbers configurations.



Stem Suspension

Individual installation — Two single-stem hangers required.



Note: 2' configurations with emergency option cannot be stem mounted.

Accessory Images

(QMB) Quick Mount Bracket

Quick Mount Bracket allows easy installation to junction boxes without having to remove any parts in the fixture.

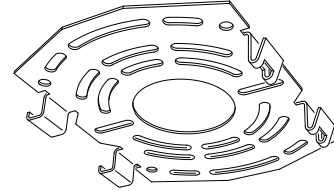

Note: 2' and 8' configurations not available with QMB accessory.

BLWPCR - continuous row mount bracket

Order one (1) BLWPCR bracket per fixture for continuous row applications (excluding BLWP as they cannot be row mounted). Order one hanger (Aircraft Cable Suspension Kit or Stem Suspension Kit) per fixture plus one per joiner required.

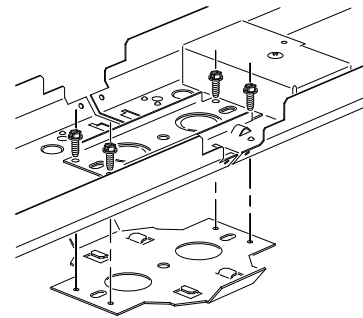

DIMENSIONS

All dimensions are inches (centimeters) unless otherwise noted.

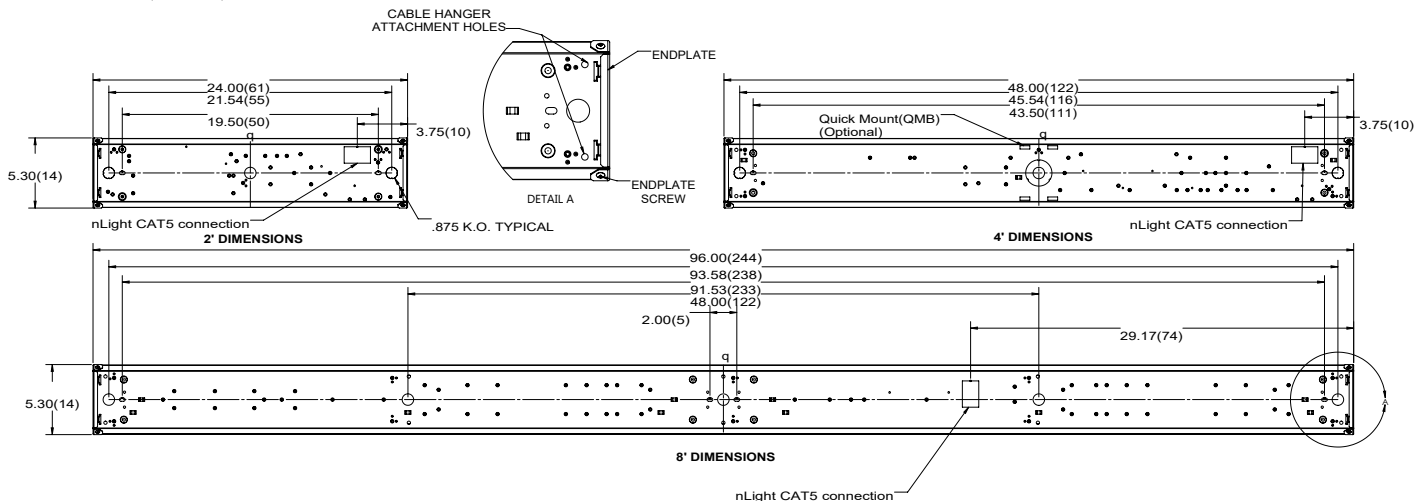

BLWP Low Profile LED Wraparound

PHOTOMETRICS

BLWP2 33L ADP LP835, 3332 delivered lumens, test no. ISF 37666, tested in accordance to IESNA LM-79.

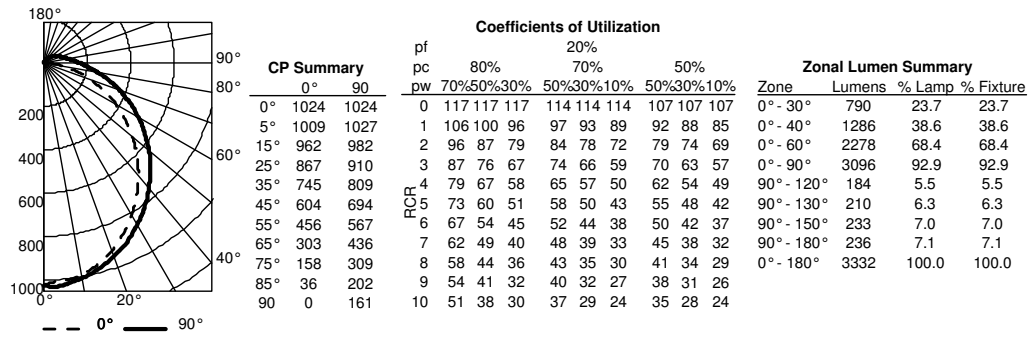

BLWP2 40L ADP LP835, 3923 delivered lumens, test no. ISF 37668, tested in accordance to IESNA LM-79.

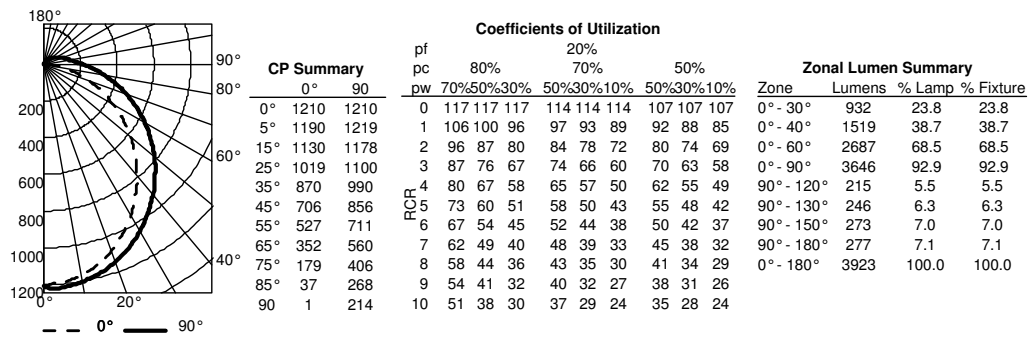

BLWP4 40L ADP LP835, 4391 delivered lumens, test no. ISF 37596, tested in accordance to IESNA LM-79.

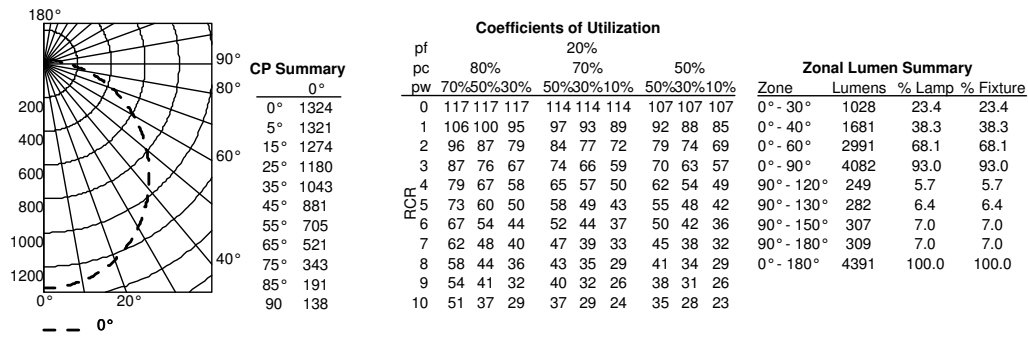

BLWP4 48L ADP LP835, 5137 delivered lumens, test no. ISF 37597, tested in accordance to IESNA LM-79.

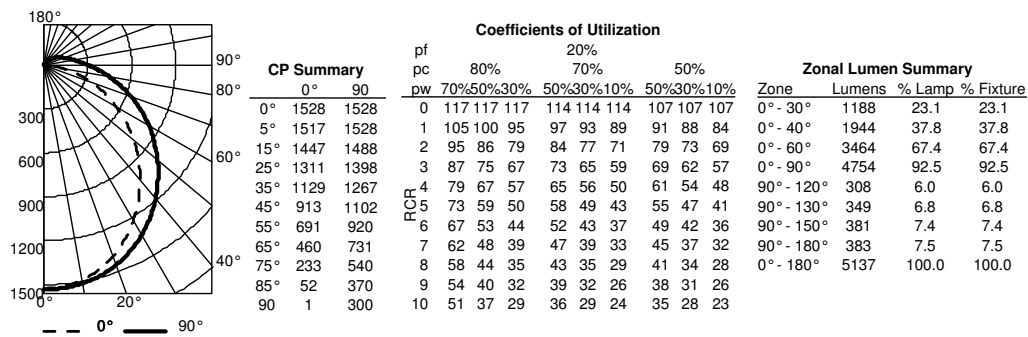

BLWP Low Profile LED Wraparound

PHOTOMETRICS

BLWP8 40L ADP LP835, 4113 delivered lumens, test no. ISF 37290P226.

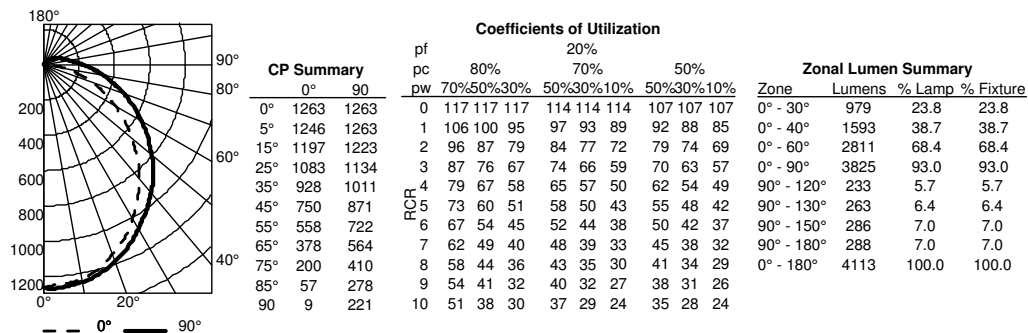

BLWP8 60L ADP LP835, 6033 delivered lumens, test no. ISF 37290P386.

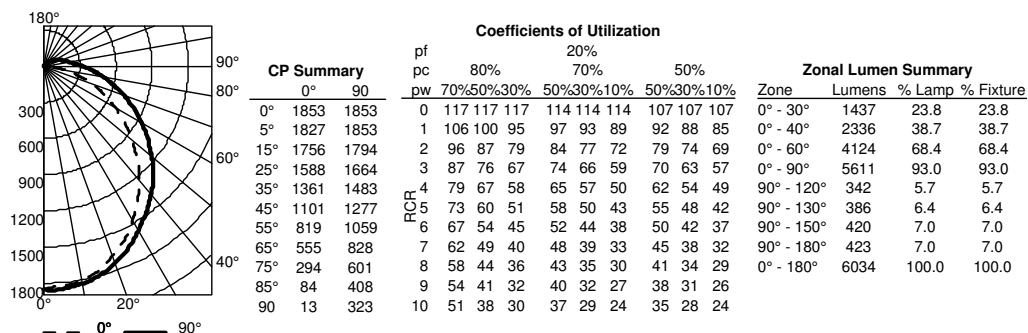

PRODUCT INFORMATION

Advanced plug-in system with three-circuit capability. Reduces fixture types on job for alternating circuit applications.

Easy one-step installation, saves up to 35% on labor costs. Expanded switching flexibility helps save energy.

Rows can be 50% longer with two-circuit systems. Polarized, lock-together nylon connectors prevent miswiring in the field. #12 THHN conductor, rated 600V, 90°C. White neutral wire included. Grounding accomplished by fixture in-row connectors.

CSA certified systems available with up to 2 circuits. G ground required.

Note: Specifications subject to change without notice.



PLR

Wiring

Advanced 1 or 2-Circuit Plug-In

ORDERING INFORMATION

Lead times will vary depending on options selected. Consult with your sales representative.

Series	Number of hot wires	Branch circuits (PLR2A / PLR2B Only)	Dimming	Ground
PLR22	(blank) Not required for PLR22	(blank) Not required for PLR22	(blank) No Dimming	G Ground (required)
PLR	1 Black	(blank) Not required for PLR1	(blank) No Dimming	G Ground (required)
	2 Black and red	Circuits to which driver is connected (blank) Not required for PLR22 A Black wire B Red wire	Battery charging circuit (must be unswitched) (blank) No battery charging circuit ELA Battery pack wired to black wire ELB Battery pack wired to red wire	LV Low-voltage Dimming G Ground (required)

Typical Applications

Notes:

When specifying PLR1, you will not specify A or B as there is only a single hot wire which would be black in color.

- Multiple-circuit and single-circuit for longer continuous rows
- Multiple-circuit with alternating fixtures on separate circuits and 2-circuit PLR22
- Multiple circuit with night-lights located along row as desired

BLWP Low Profile LED Wraparound

Constant Lumen Management

Enabled by the embedded nLight control, the BLT actively tracks its run-time and manages its light source such that constant lumen output is maintained over the system life. Referred to as lumen management, this feature eliminates the energy waste created by the traditional practice of over-lighting.

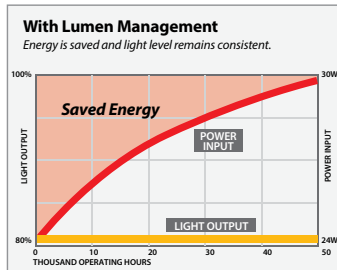
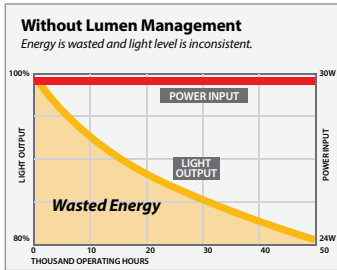

How to Estimate Lumens in Emergency Mode

Use the formula below to estimate the delivered lumens in emergency mode

$$\text{Estimated Lumens} = 1.25 \times P \times \text{LPW}$$

P = Output power of emergency driver. P = 10W for E10WLCP option.

LPW = Lumen per watt rating of the luminaire. LPW information available in Performance Data section.

BLWP PERFORMANCE DATA ²⁴

Lumen Package	Lumens	Input Watts	LPW
BLWP2 8L ADP LP830	825	7	118
BLWP2 8L ADP LP835	855	7	122
BLWP2 8L ADP LP840	868	7	124
BLWP2 8L ADP LP850	893	7	128
BLWP2 20L ADP LP830	1876	17	110
BLWP2 20L ADP LP835	1942	17	114
BLWP2 20L ADP LP840	1973	17	116
BLWP2 20L ADP LP850	2029	17	119
BLWP2 33L ADP LP830	3180	30	107
BLWP2 33L ADP LP835	3332	30	112
BLWP2 33L ADP LP840	3345	30	112
BLWP2 33L ADP LP850	3440	30	115
BLWP2 40L ADP LP830	3914	37	105
BLWP2 40L ADP LP835	3923	37	105
BLWP2 40L ADP LP840	4117	37	110
BLWP2 40L ADP LP850	4234	37	113
BLWP2 48L ADP LP830	4772	44	109
BLWP2 48L ADP LP835	4940	44	112
BLWP2 48L ADP LP840	5019	44	114
BLWP2 48L ADP LP850	5162	44	118
BLWP4 15L ADP LP830	1372	11	126
BLWP4 15L ADP LP835	1420	11	129
BLWP4 15L ADP LP840	1443	11	131
BLWP4 15L ADP LP850	1484	11	135
BLWP4 20L ADP LP830	1985	16	124
BLWP4 20L ADP LP835	2055	16	128
BLWP4 20L ADP LP840	2088	16	131
BLWP4 20L ADP LP850	2147	16	134
BLWP4 30L ADP LP830	2960	25	118
BLWP4 30L ADP LP835	3065	25	123
BLWP4 30L ADP LP840	3114	25	125
BLWP4 30L ADP LP850	3203	25	128
BLWP4 40L ADP LP830	4027	35	115
BLWP4 40L ADP LP835	4391	35	125
BLWP4 40L ADP LP840	4236	35	121
BLWP4 40L ADP LP850	4357	35	124
BLWP4 48L ADP LP830	4948	40	124
BLWP4 48L ADP LP835	5137	40	129
BLWP4 48L ADP LP840	5205	40	131
BLWP4 48L ADP LP850	5353	40	134
BLWP4 60L ADP LP830	6059	49	123
BLWP4 60L ADP LP835	6273	49	127
BLWP4 60L ADP LP840	6373	49	129
BLWP4 60L ADP LP850	6555	49	133
BLWP4 72L ADP LP830	7088	59	121
BLWP4 72L ADP LP835	7338	59	125
BLWP4 72L ADP LP840	7455	59	127
BLWP4 72L ADP LP850	7668	59	131
BLWP4 85L ADP LP830	7972	68	117
BLWP4 85L ADP LP835	8253	68	121
BLWP4 85L ADP LP840	8385	68	123
BLWP4 85L ADP LP850	8624	68	127
BLWP4 100L ADP LP830	9316	85	110
BLWP4 100L ADP LP835	9645	85	114
BLWP4 100L ADP LP840	9799	85	116
BLWP4 100L ADP LP850	10079	85	119

BLWP PERFORMANCE DATA (continued)

Lumen Package	Lumens	Input Watts	LPW
BLWP2 8LHE ADP LP830	851	8	106
BLWP2 8LHE ADP LP835	881	8	110
BLWP2 8LHE ADP LP840	895	8	112
BLWP2 8LHE ADP LP850	921	8	115
BLWP2 20LHE ADP LP830	1932	16	120
BLWP2 20LHE ADP LP835	2000	16	125
BLWP2 20LHE ADP LP840	2032	16	127
BLWP2 20LHE ADP LP850	2090	16	130
BLWP2 33LHE ADP LP830	3272	26	127
BLWP2 33LHE ADP LP835	3388	26	131
BLWP2 33LHE ADP LP840	3442	26	133
BLWP2 33LHE ADP LP850	3540	26	137
BLWP2 40LHE ADP LP830	3991	32	126
BLWP2 40LHE ADP LP835	4132	32	130
BLWP2 40LHE ADP LP840	4198	32	131
BLWP2 40LHE ADP LP850	4318	32	136
BLWP2 48LHE ADP LP830	4881	39	126
BLWP2 48LHE ADP LP835	5053	39	130
BLWP2 48LHE ADP LP840	5134	39	132
BLWP2 48LHE ADP LP850	5280	39	136
BLWP4 15LHE ADP LP830	1375	11	125
BLWP4 15LHE ADP LP835	1424	11	129
BLWP4 15LHE ADP LP840	1447	11	132
BLWP4 15LHE ADP LP850	1488	11	135
BLWP4 20LHE ADP LP830	1985	16	124
BLWP4 20LHE ADP LP835	2055	16	128
BLWP4 20LHE ADP LP840	2088	16	131
BLWP4 20LHE ADP LP850	2147	16	134
BLWP4 30LHE ADP LP830	3012	24	126
BLWP4 30LHE ADP LP835	3118	24	131
BLWP4 30LHE ADP LP840	3168	24	133
BLWP4 30LHE ADP LP850	3258	24	137
BLWP4 40LHE ADP LP830	4181	33	127
BLWP4 40LHE ADP LP835	4329	33	132
BLWP4 40LHE ADP LP840	4398	33	134
BLWP4 40LHE ADP LP850	4524	33	137
BLWP4 48LHE ADP LP830	5033	39	130
BLWP4 48LHE ADP LP835	5211	39	135
BLWP4 48LHE ADP LP840	5294	39	137
BLWP4 48LHE ADP LP850	5445	39	141
BLWP4 60LHE ADP LP830	6280	47	133
BLWP4 60LHE ADP LP835	6502	47	137
BLWP4 60LHE ADP LP840	6606	47	140
BLWP4 60LHE ADP LP850	6795	47	144
BLWP4 72LHE ADP LP830	7303	56	129
BLWP4 72LHE ADP LP835	7561	56	134
BLWP4 72LHE ADP LP840	7682	56	136
BLWP4 72LHE ADP LP850	7901	56	140
BLWP4 85LHE ADP LP830	8567	69	124
BLWP4 85LHE ADP LP835	8869	69	129
BLWP4 85LHE ADP LP840	9011	69	131
BLWP4 85LHE ADP LP850	9268	69	134
BLWP4 100LHE ADP LP830	9898	80	124
BLWP4 100LHE ADP LP835	10247	80	128
BLWP4 100LHE ADP LP840	10411	80	130
BLWP4 100LHE ADP LP850	10708	80	134

Notes

24 For ADP lens only, for additional lens options refer to photometry on www.acuitybrands.com.

BLWP Low Profile LED Wraparound

BLWP8 PERFORMANCE DATA

Lumen Package	Lumens	Input Watts	LPW
BLWP8 40L ADP LP830	3953	30	131
BLWP8 40L ADP LP835	4113	30	136
BLWP8 40L ADP LP840	4107	30	136
BLWP8 40L ADP LP850	4246	30	141
BLWP8 60L ADP LP830	5799	47	122
BLWP8 60L ADP LP835	6034	47	127
BLWP8 60L ADP LP840	6107	47	130
BLWP8 60L ADP LP850	6229	47	132
BLWP8 80L ADP LP830	7643	63	121
BLWP8 80L ADP LP835	7952	63	126
BLWP8 80L ADP LP840	8035	63	127
BLWP8 80L ADP LP850	8210	63	130
BLWP8 100L ADP LP830	9628	82	118
BLWP8 100L ADP LP835	10017	82	123
BLWP8 100L ADP LP840	10133	82	124
BLWP8 100L ADP LP850	10342	82	127
BLWP8 140L ADP LP830	13265	120	111
BLWP8 140L ADP LP835	13802	120	115
BLWP8 140L ADP LP840	13961	120	116
BLWP8 140L ADP LP850	14249	120	119
BLWP8 180L ADP LP830	17781	147	121
BLWP8 180L ADP LP835	18501	147	126
BLWP8 180L ADP LP840	18714	147	127
BLWP8 180L ADP LP850	19101	147	130
BLWP8 200L ADP LP830	18563	156	119
BLWP8 200L ADP LP835	19314	156	124
BLWP8 200L ADP LP840	19537	156	125
BLWP8 200L ADP LP850	19941	156	128

BLWP8 HE PERFORMANCE DATA

Lumen Package	Lumens	Input Watts	LPW
BLWP8 40LHE ADP LP830	3953	30	133
BLWP8 40LHE ADP LP835	4113	30	139
BLWP8 40LHE ADP LP840	4160	30	140
BLWP8 40LHE ADP LP850	4246	30	143
BLWP8 60LHE ADP LP830	5942	46	128
BLWP8 60LHE ADP LP835	6183	46	133
BLWP8 60LHE ADP LP840	6254	46	135
BLWP8 60LHE ADP LP850	6383	46	137
BLWP8 80LHE ADP LP830	7820	59	132
BLWP8 80LHE ADP LP835	8136	59	137
BLWP8 80LHE ADP LP840	8230	59	139
BLWP8 80LHE ADP LP850	8400	59	142
BLWP8 100LHE ADP LP830	9723	74	132
BLWP8 100LHE ADP LP835	10117	74	138
BLWP8 100LHE ADP LP840	10233	74	139
BLWP8 100LHE ADP LP850	10445	74	142
BLWP8 140LHE ADP LP830	13491	104	129
BLWP8 140LHE ADP LP835	14037	104	135
BLWP8 140LHE ADP LP840	14198	104	136
BLWP8 140LHE ADP LP850	14492	104	139
BLWP8 180LHE ADP LP830	17245	130	133
BLWP8 180LHE ADP LP835	17943	130	138
BLWP8 180LHE ADP LP840	18150	130	140
BLWP8 180LHE ADP LP850	18525	130	143
BLWP8 200LHE ADP LP830	19587	144	136
BLWP8 200LHE ADP LP835	20380	144	141
BLWP8 200LHE ADP LP840	20615	144	143
BLWP8 200LHE ADP LP850	21041	144	146

Notes

24 For ADP lens only, for additional lens options refer to photometry on www.acuitybrands.com.