



CONNECT AND PROTECT

nVent ERICO Cadweld Installation and Inspection Guide

WARNING

1. nVent ERICO products shall be installed and used only as indicated in nVent ERICO product instruction sheets and training materials. Instruction sheets are available at nVent.com/ERICO and from your nVent ERICO customer service representative.
2. nVent ERICO products must never be used for a purpose other than the purpose for which they were designed or in a manner that exceeds specified load ratings.
3. All instructions must be completely followed to ensure proper and safe installation and performance.
4. Improper installation, misuse, misapplication or other failure to completely follow nVent ERICO's instructions and warnings may cause product malfunction, property damage, serious bodily injury and death.

GENERAL AND SAFETY INSTRUCTIONS:

- A. Only nVent ERICO manufactured equipment and materials should be used to make nVent ERICO Cadweld connections.
- B. Do not connect items except as detailed in instruction sheets. Failure to comply with these instructions may result in improper and unsafe connections, damage to items being connected, bodily injury and property damage.
- C. Do not use worn or broken equipment which could cause leakage.
- D. Do not alter equipment or material without nVent ERICO authorization.
- E. When using Cadweld do not use welding material package if damaged or not fully intact. When using Cadweld Plus, do not tamper with or disassemble the welding material unit.
- F. Make connections in conformance with Cadweld instructions and all governing codes.
 1. Personnel should be properly trained in the use of this product and must wear safety glasses and gloves.
 2. Avoid contact with hot materials.
 3. Advise nearby personnel of welding operations in the area.
 4. Remove or protect fire hazards in the immediate area.
 5. Provide adequate ventilation to the work area.
 6. Do not smoke when handling starting material.
 7. Avoid direct eye contact with "flash" of light from ignition of starting material.
- G. Welding material is an exothermic mixture and reacts to produce hot molten material with temperatures in excess of 1400°C (2500°F) and a localized release of smoke. These materials are not explosive. Ignition temperatures are in excess of 900°C (1650°F) for welding material.
- H. Adhering to the Cadweld welding procedures will minimize risk of burns and fire caused by hot molten material spillage. In case of fire, use of water or CO₂ will aid in control of burning containers. Large quantities of water will aid in controlling a fire should the exothermic materials become involved. Water should be applied from a distance.
 1. Make sure there is proper mold fit and assembly of equipment.
 2. Avoid moisture and contaminants in mold and materials being welded. Contact between hot molten metal and moisture or contaminants may result in spewing of hot material.
 3. Base material thickness must be sufficient for the size and type of connection being made to prevent melt-through and leakage of hot molten metal.
- I. Applications or conditions may exist which require special considerations. The following are examples, but are not intended to be a complete listing of applications/conditions.

CONNECTIONS TO PIPE/VESSELS

For use with cast iron pipe or heavy casting meeting ASTM A47-84, A48-83, A126-84, A278-85, or A377-89. DO NOT USE ON CAST IRON SOIL PIPE (ASTM A74-93). Evaluate possible effects of Cadweld connections to structural members and thin-wall materials; vessels/piping systems that are pressurized, closed or containing (or having contained) flammable/explosive/hazardous materials. Evaluation should be made prior to use, based on conditions of use and applicable codes, and should incorporate as a minimum, effects of melt-through of hot material; structural/metallurgical effects of Cadweld connections, pressure (temperature) build-up and fire/chemical decomposition hazards.

CONNECTIONS TO REBAR

Application of the Cadweld connection may have an effect on the rebar's structural integrity. The rebar's chemistry and the location of the weld should be considered before making any welds to the rebar. For lapped rebar splices, it is recommended that the connections be made near the bar end at an area of minimum stress. If Cadweld Rebar Splices are used, the grounding connection can be made to the splice sleeve with minimal effect on the structural characteristics of the splice.

SAFETY INSTRUCTIONS:

All governing codes and regulations and those required by the job site must be observed. Always use appropriate safety equipment such as eye protection, hard hat, and gloves as appropriate to the application.

WARRANTY

Cadweld products are warranted to be free from defects in material and workmanship at the time of shipment. NO OTHER WARRANTY, WHETHER EXPRESS OR IMPLIED (INCLUDING ANY WARRANTY OF MERCHANTABILITY OR FITNESS FOR A PARTICULAR PURPOSE), SHALL EXIST IN CONNECTION WITH THE SALE OR USE OF ANY nVent ERICO PRODUCTS. Claims for errors, shortages, defects or nonconformities ascertainable upon inspection must be made in writing within 5 days after Buyer's receipt of products. All other claims must be made in writing to nVent ERICO within 6 months from the date of shipment or transport. Products claimed to be nonconforming or defective must, upon nVent ERICO's prior written approval in accordance with its standard terms and procedures governing returns, promptly be returned to nVent ERICO for inspection. Claims not made as provided above and within the applicable time period will be barred. nVent ERICO shall in no event be responsible if the products have not been stored or used in accordance with its specifications and recommended procedures. nVent ERICO will, at its option, either repair or replace nonconforming or defective products for which it is responsible or return the purchase price to the Buyer. THE FOREGOING STATES BUYER'S EXCLUSIVE REMEDY FOR ANY BREACH OF nVent ERICO WARRANTY AND FOR ANY CLAIM, WHETHER SOUNDING IN CONTRACT, TORT OR NEGLIGENCE, FOR LOSS OR INJURY CAUSED BY THE SALE OR USE OF ANY PRODUCT.

LIMITATION OF LIABILITY

nVent ERICO excludes all liability except such liability that is directly attributable to the willful or gross negligence of nVent ERICO's employees. Should nVent ERICO be held liable its liability shall in no event exceed the total purchase price under the contract. nVent ERICO SHALL IN NO EVENT BE RESPONSIBLE FOR ANY LOSS OF BUSINESS OR PROFITS, DOWNTIME OR DELAY, LABOR, REPAIR OR MATERIAL COSTS OR ANY SIMILAR OR DISSIMILAR CONSEQUENTIAL LOSS OR DAMAGE INCURRED BY BUYER.

nVent ERICO Cadweld

The nVent ERICO Cadweld exothermic welding process is a method of making electrical connections with copper-to-copper or copper-to-steel in which no outside source of heat or power is required.

In this process, conductors are prepared, placed in a purpose-designed graphite mold, and exothermically welded to produce a permanent electrical connection.

The steps outlined in this guide are a general demonstration of a typical welded connection. These basic steps are used for all Cadweld electrical connections. Be sure to read and follow the instructions included with every mold before making a connection.

The Cadweld exothermic process is a system. Materials from other manufacturers should not be mixed or matched with Cadweld molds or welding material.

Table of Contents

nVent ERICO Cadweld.....	1-7
nVent ERICO Cadweld Plus.....	8-12
nVent ERICO Cadweld Exolon.....	13-19
nVent ERICO Cadweld One Shot.....	20-23
nVent ERICO Cadweld Plus One Shot.....	24-27
nVent ERICO Cadweld Quality Standards.....	28-35

nVent ERICO Cadweld



Fig. 1 – Always wear protective safety glasses and gloves while working with Cadweld exothermic welding products.



Fig. 3 – Check to ensure the graphite mold is not worn or broken, which could cause leakage of molten weld metal during the reaction.



Fig. 2 – Gather the proper materials and equipment for the type of connection you are making. The typical Cadweld system requires a graphite mold, handle clamp, welding material, natural bristle brush for mold cleaning, wire brush for cleaning/preparing conductors, flint igniter, and propane torch.

NOTE: Additional materials may be required for your specific application. Refer to your mold instructions. Advise nearby personnel of welding operations in the area prior to ignition.

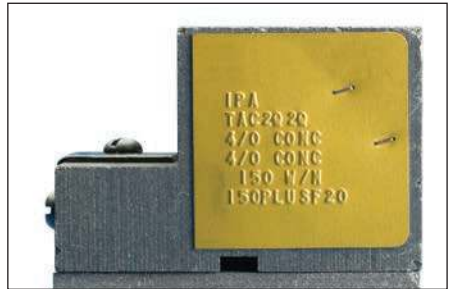

Fig. 4 – Inspect the mold ID tag to ensure that it corresponds to the application, indicated by the:

1. mold part number
2. conductor size
3. welding material required
4. other materials required

The mold must be correct for the conductor size and application.

DO NOT MODIFY MOLDS.

nVent ERICO Cadweld



Fig. 5 – Remove the small wire bracket which is used to temporarily hold the mold together before using. Set the bracket aside.



Fig. 8 – Close the grips to tightly lock the mold. Check for an appropriate seal on the mold.



Fig. 6 – Slide the handle clamp into the pre-drilled holes with the proper orientation for the thumbscrews.



Fig. 9 – If the mold does not seal properly, make adjustments to tighten/loosen the handle clamp.



Fig. 7 – Tighten the clamp thumbscrews onto the mold.



Fig. 10 – Graphite absorbs moisture. Ignite the propane torch and dry out the inside of the mold thoroughly on both sides, heating the mold to approximately 250 degrees Fahrenheit (120 degrees Celsius).

nVent ERICO Cadweld



Fig. 11 – The conductors should be clean and dry before the connection is made. Use a propane torch to dry wire conductors and remove remaining cleaning residue, solvent, or water before making the Cadweld connection.



Fig. 12 – Next, use a wire brush to further prepare the surface of the conductors (nVent ERICO T-313 or T-314 brush). Scrape the outer surface to remove dirt and oxidation. You will notice a slight color change.

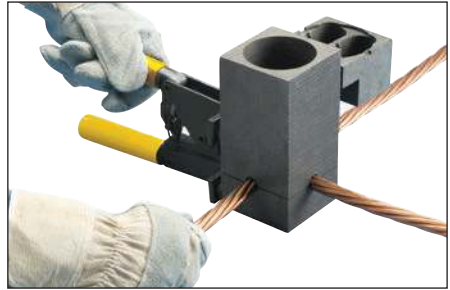

Fig. 13 – Insert the conductors and position them for the connection.

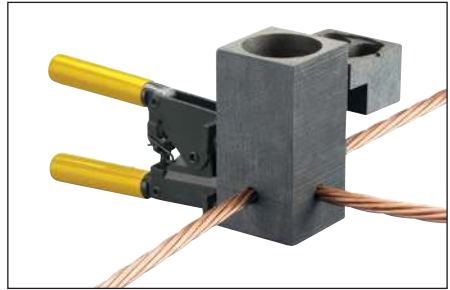

Fig. 14 – Close the clamp tightly once the conductors are properly positioned.



Fig. 15 – Locate the steel disk found inside the packaging box of welding material.

nVent ERICO Cadweld



Fig. 16 – Insert the steel disk (concave side up) into the mold. Hold the steel disk on the side of the mold and let it slide into place.



Fig. 17 – Ensure that the steel disk is properly seated.



Fig. 18 – Next, take a tube of properly sized welding material (as identified on the mold ID tag) out of the box.



Fig. 19 – Remove the lid over the mold crucible.



Fig. 20 – Quickly pour the loose welding material powder into the mold.



Fig. 21 – The bottom of the tube contains compressed material (starting material). Tap the bottom of the tube a couple of times to loosen this material.

nVent ERICO Cadweld

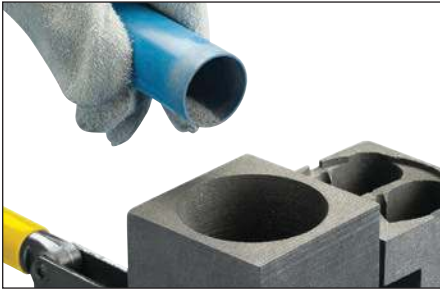

Fig. 22 – Pour 1/4 to 1/3 of the starting material over the welding material in the mold crucible.



Fig. 23 – Close the lid and pour the remaining 3/4 to 2/3 of the starting material into the slot on the mold cover.

NOTE: Welding material is an exothermic mixture and reacts to produce hot molten material with temperatures in excess of 2500 degrees Fahrenheit (1400 degrees Celsius) and a localized release of smoke. Avoid looking directly at the “flash” of light from ignition of starting material. Avoid inhalation of smoke/fumes.

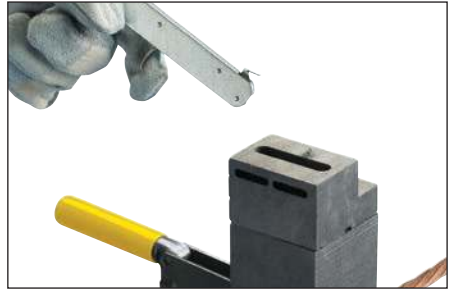

Fig. 24 – Aiming the flint igniter from the side, ignite the starting material on the mold cover. Withdraw the igniter quickly to prevent fouling.

Allow approximately 30 seconds for completion of the reaction and solidification of the molten material.



Fig. 25 – Open the mold and remove the connection. Use care to prevent chipping the mold. Avoid contact with hot materials. See the “nVent ERICO Cadweld Quality Standards” section to see whether a quality connection has been made.

nVent ERICO Cadweld

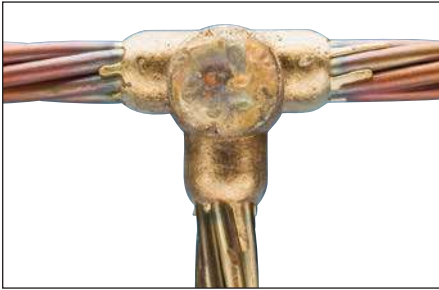

Fig. 26 – Completed Cadweld connection.



Fig. 27 – Cadweld graphite molds will last for approximately 50 connections. Use a soft cotton cloth or a soft bristle brush (nVent ERICO part #T394) to clean inside the mold cavity and cover.

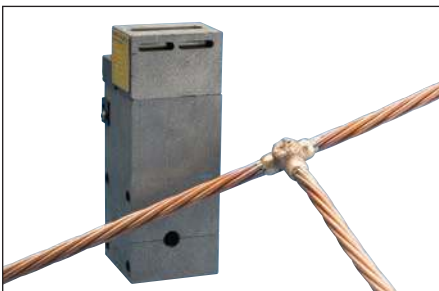

Fig. 28 – Ready to make another Cadweld connection.

nVent ERICO Cadweld Plus



Fig. 1 – Always wear protective safety glasses and gloves while working with Cadweld Plus exothermic products.



Fig. 3 – Check to ensure the graphite mold is not worn or broken, which could cause leakage of molten weld metal during the reaction.



Fig. 2 – Prepare the proper materials and equipment for the type of connection you are making. The Cadweld Plus system requires a graphite mold, mold clamp, Cadweld Plus welding material cup, natural bristle brush for mold cleaning, wire brush for cleaning/preparing conductors, control unit, and propane torch.

NOTE: Additional materials may be required for your specific application. Refer to your mold instructions. Advise nearby personnel of welding operations in the area prior to ignition.

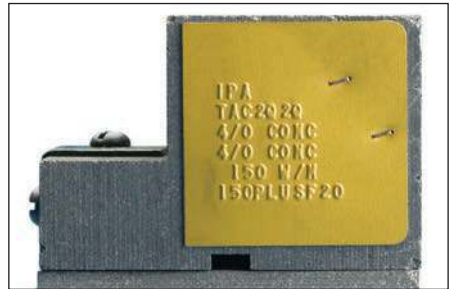

Fig. 4 – Inspect the mold ID tag to ensure that it corresponds to the application, indicated by the:

1. mold part number
2. conductor size
3. welding material required
4. other materials required

The mold must be correct for the conductor size and application.

DO NOT MODIFY MOLDS.

nVent ERICO Cadweld Plus



Fig. 5 – Remove the small wire bracket which is used to temporarily hold the mold together before using. Set the bracket aside.



Fig. 6 – Slide the handle clamp into the pre-drilled holes with the proper orientation for the thumbscrews.



Fig. 7 – Tighten the clamp thumbscrews onto the mold.



Fig. 8 – Close the grips to tightly lock the mold. Check for an appropriate seal on the mold.

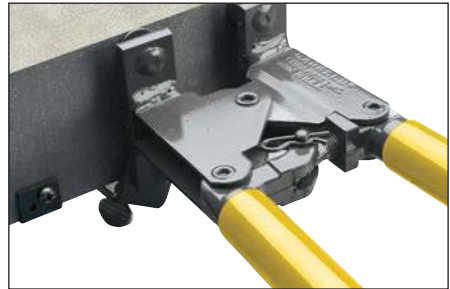

Fig. 9 – If the mold does not seal properly, make adjustments to tighten/loosen the handle clamp.



Fig. 10 – Graphite absorbs moisture. Ignite the propane torch and dry out the inside of the mold thoroughly on both sides, heating the mold to approximately 250 degrees Fahrenheit (120 degrees Celsius).

nVent ERICO Cadweld Plus



Fig. 11 – The conductors should be clean and dry before the connection is made. Use a propane torch to dry wire conductors and remove remaining cleaning residue, solvent, or water before making the Cadweld connection.



Fig. 12 – Next, use a wire brush to further prepare the surface of the conductors (nVent ERICO T-313 or T-314 brush). Scrape the outer surface to remove dirt and oxidation. You will notice a slight color change.



Fig. 13 – Insert the conductors and position them for the connection.

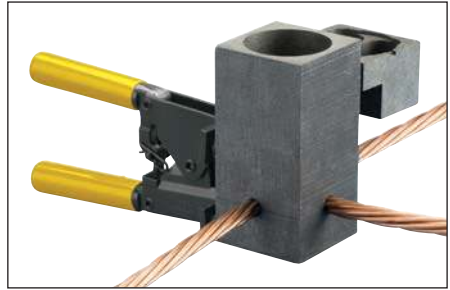

Fig. 14 – Close the clamp tightly once the conductors are properly positioned.



Fig. 15 – Remove the proper Cadweld Plus welding material cup from the plastic container. Inspect the cup to ensure it is tightly sealed and the ignition strip is securely attached to the seal.

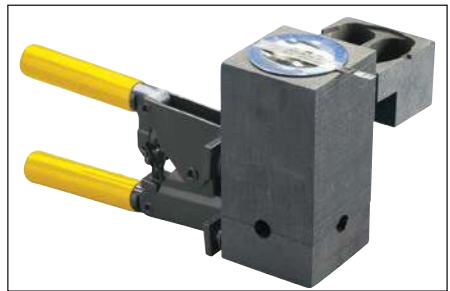

Fig. 16 – Place the cup into the top of the mold. Make sure the ignition strip nests into the recess on the top edge when the cover is closed.

nVent ERICO Cadweld Plus



Fig. 17 – Battery-powered nVent ERICO Cadweld Plus Impulse Exothermic Welding Control Unit.

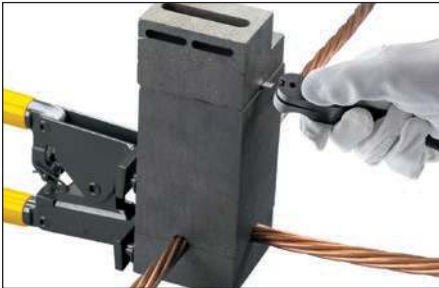

Fig. 18 – Place the ignition strip into the control unit connector. Remove or protect fire hazards in close proximity to the connection.

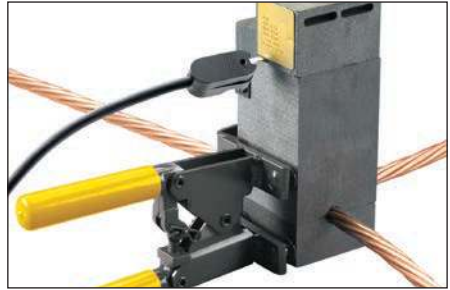

Fig. 19 – Close the graphite mold lid. Advise nearby personnel of welding operations in the area.



Fig. 20 – Using the nVent ERICO Cadweld Plus Impulse Exothermic Welding Control Unit, lift the trigger cover and press the ignition button and hold. You will see the 6 lights on the top of the control unit light up as it is charging. After the 6th light is illuminated, the control unit will send a charge to the ignition strip, initiating the Cadweld Plus exothermic reaction.

Allow approximately 30 seconds for completion of the reaction and solidification of the molten material.

nVent ERICO Cadweld Plus



Fig. 21 – Remove the control unit connector from the ignition strip. Open the lid and remove the used Cadweld Plus cup from the mold.

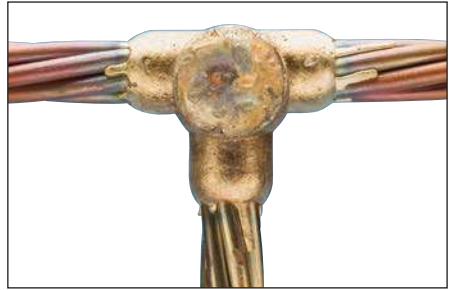

Fig. 23 – Completed Cadweld connection.



Fig. 22 – Open the mold and remove the connection. Use care to prevent chipping the mold. Avoid contact with hot materials. See the “nVent ERICO Cadweld Quality Standards” section to see whether a quality connection has been made.



Fig. 24 – Cadweld graphite molds will last for approximately 50 connections. Use a soft cotton cloth or a soft bristle brush (nVent ERICO part #T394) to clean inside the mold cavity and cover.

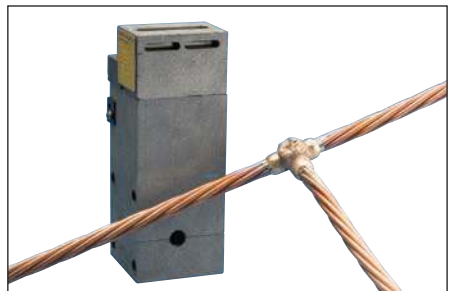

Fig. 25 – Ready to make another Cadweld connection.

nVent ERICO Cadweld Exolon



Fig. 1 – Always wear protective safety glasses and gloves while working with Cadweld exothermic products.



Fig. 3 – Check to ensure the graphite mold is not worn or broken, which could cause leakage of molten weld metal during the reaction.



Fig. 2 – Prepare the proper materials and equipment for the type of connection you are making. The Cadweld Exolon system requires a Cadweld Exolon graphite mold, handle clamp, welding material, wire brush for cleaning/preparing conductors, battery pack, and propane torch.

NOTE: Additional materials may be required for your specific application. Refer to your mold instructions. Advise nearby personnel of welding operations in the area prior to ignition.

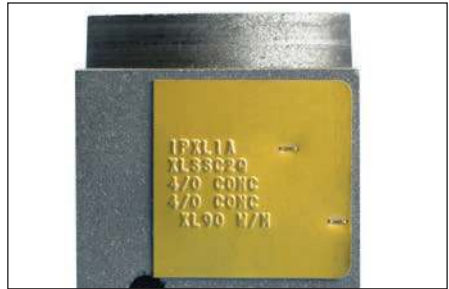

Fig. 4 – Inspect the mold ID tag to ensure that it corresponds to the application, indicated by the:

1. mold part number
2. conductor size
3. welding material required
4. other materials required

The mold must be correct for the conductor size and application.

DO NOT MODIFY MOLDS.

nVent ERICO Cadweld Exolon



Fig. 5 – Remove the small wire bracket which is used to temporarily hold the mold together before using. Set the bracket aside.

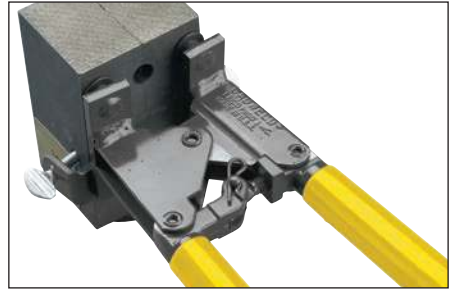

Fig. 8 – Close the grips to tightly lock the mold. Check for an appropriate seal on the mold.



Fig. 6 – Slide the handle clamp into the pre-drilled holes with the proper orientation for the thumbscrews.



Fig. 9 – If the mold does not seal properly, make adjustments to the handle clamp.



Fig. 7 – Tighten the clamp thumbscrews onto the mold.

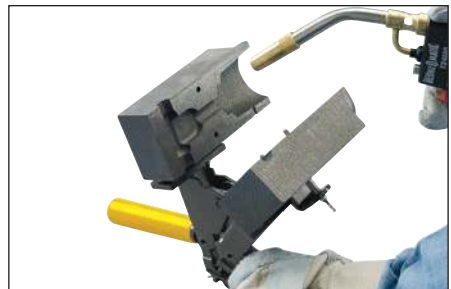

Fig. 10 – Graphite absorbs moisture. Ignite the propane torch and dry out the inside of the mold thoroughly on both sides, heating the mold to approximately 250 degrees Fahrenheit (120 degrees Celsius).

nVent ERICO Cadweld Exolon



Fig. 11 – The conductors should be clean and dry before the connection is made. Use a propane torch to dry wire conductors and remove remaining cleaning residue, solvent, or water before making the Cadweld connection.



Fig. 12 – Next, use a wire brush to further prepare the surface of the conductors and ground rod (nVent ERICO T-313 or T-314 brush). Scrape the outer surface to remove dirt and oxidation. You will notice a slight color change.



Fig. 13 – Weld metal package (includes welding material, discs, filters and ignitors for 4 connections).



Fig. 14 – Each Exolon package contains 2 filters for a low emission connection. Insert the white ceramic and black graphite filters into the mold cover. (Filters must be changed every 4 connections.)

NOTE: If using XL200 welding material or higher, 3 filters (1 white, 2 black) are included in the weld metal package. Insert the white filter between the black filters.

nVent ERICO Cadweld Exolon



Fig. 15 – Insert the conductors and position them for the connection.



Fig. 18 – Insert the steel disk (concave side up) into the mold. Hold the steel disk on the side of the mold and let it slide into place.



Fig. 16 – Close the clamp tightly once the conductors are properly positioned.



Fig. 19 – Ensure that the steel disk is properly seated.



Fig. 17 – Locate the steel disk found inside the packaging box of welding material.



Fig. 20 – Next, take the tube of welding material included in the Cadweld Exolon package and remove the lid over the mold crucible.

nVent ERICO Cadweld Exolon



Fig. 21 – Pour the loose welding material powder into the Cadweld Exolon mold.

NOTE: Welding material is an exothermic mixture and reacts to produce hot molten material with temperatures in excess of 2500 degrees Fahrenheit (1400 degrees Celsius) and a localized release of smoke. Avoid direct eye contact with “flash” of light from ignition of starting material. Avoid inhalation of smoke/fumes.



Fig. 22 – Place the graphite Cadweld Exolon cover onto the mold, with the larger side facing down.



Fig. 23 – Next, take an igniter pin and place it halfway into the small hole on the side of the mold, with the loop side facing into the hole. Spread the wire leads.



Fig. 24 – Cadweld Exolon battery pack.

nVent ERICO Cadweld Exolon

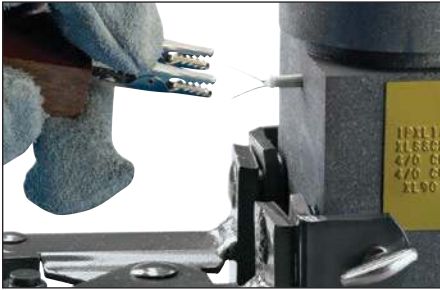

Fig. 25 – Take the alligator clips and clip them onto the wire leads. Remove or protect fire hazards in close proximity to the connection. Advise nearby personnel of welding operations in the area.



Fig. 27 – Remove the alligator clips from the igniter pin. Remove the graphite cover of the Cadweld Exolon mold.



Fig. 26 – Using the Cadweld Exolon battery pack, press the button. At this time, the unit will send a charge to the igniter pin. The igniter pin will initiate the Cadweld Exolon exothermic reaction.

Allow approximately 30 seconds for completion of the reaction and solidification of the molten material.



Fig. 28 – Open the mold and remove the connection. Use care to prevent chipping the mold. Avoid contact with hot materials. See the “Cadweld Quality Standards” section to see whether a quality connection has been made.



Fig. 29 – Completed Cadweld connection.

nVent ERICO Cadweld Exolon

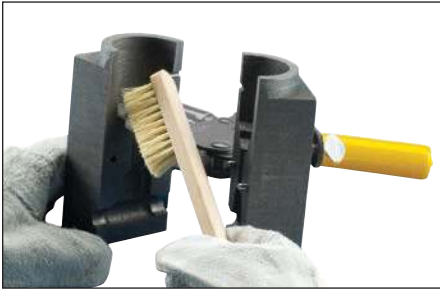

Fig. 30 – Cadweld Exolon graphite molds will last for approximately 50 connections. Use a soft cotton cloth or a soft bristle brush (nVent ERICO part #T394) to clean inside the mold cavity and cover; remove any slag left from the exothermic reaction.



Fig. 31 – Ready to make another Cadweld connection.

nVent ERICO Cadweld One Shot



Fig. 1 – Always wear protective safety glasses and gloves while working with Cadweld exothermic products.



Fig. 2 – Gather the proper materials and equipment for the type of connection you are making. The Cadweld One Shot system requires a Cadweld One Shot ceramic mold, welding material, wire brush for cleaning/preparing conductors, flint igniter, and propane torch.

NOTE: Additional materials may be required for your specific application. Refer to your mold instructions. Advise nearby personnel of welding operations in the area prior to ignition.



Fig. 3 – Check to ensure the ceramic mold is not broken, which could cause leakage of molten weld metal during the reaction.

Inspect the Cadweld One Shot box label to ensure that it corresponds to the application, indicated by the:

1. Cadweld One Shot part number
2. conductor size
3. welding material required
4. other materials required

The mold must be correct for the conductor size and application.

DO NOT MODIFY MOLDS.



Fig. 4 – The conductors should be clean and dry before the connection is made. Use a propane torch to dry wire conductors and remove remaining cleaning residue, solvent, or water before making the Cadweld One Shot connection.

nVent ERICO Cadweld One Shot

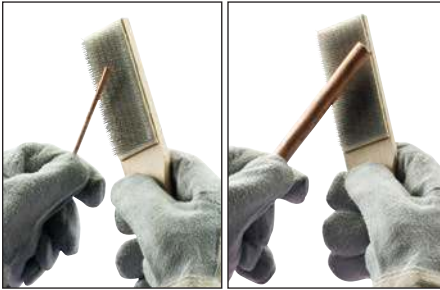

Fig. 5 – Next, use a wire brush to further prepare the surface of the conductors and ground rod (Cadweld T-313 or T-314 brush). Scrape the outer surface to remove dirt and oxidation. You will notice a slight color change.



Fig. 6 – Each Cadweld One Shot contains a rubber grommet at the bottom of the mold. Gently turn the Cadweld One Shot onto the ground rod until the ground rod reaches the stopper and cannot go any further.

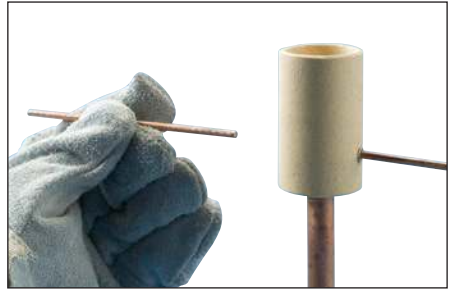

Fig. 7 – Insert the conductors and position them for the connection.



Fig. 8 – Place the steel disk into the Cadweld One Shot with the concave side facing up.



Fig. 9 – Ensure that the steel disk is properly seated inside the Cadweld One Shot.

nVent ERICO Cadweld One Shot



Fig. 10 – Next, take the tube of welding material included in the Cadweld One Shot package and remove the lid over the crucible.

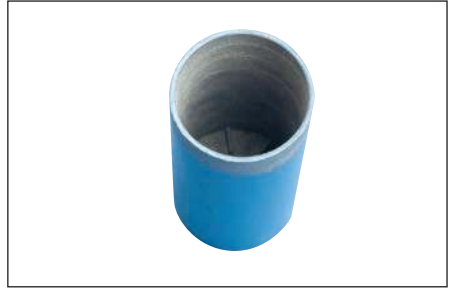

Fig. 13 – The bottom of the tube contains compressed material (starting material). Tap the bottom of the tube a couple of times to loosen this material.



Fig. 11 – Pour the loose welding material powder into the Cadweld One Shot mold.



Fig. 14 – Pour the starting material onto the Cadweld One Shot cover.



Fig. 12 – Place the cover on the top of the Cadweld One Shot.

NOTE: Welding material is an exothermic mixture and reacts to produce hot molten material with temperatures in excess of 2500 degrees Fahrenheit (1400 degrees Celsius) and a localized release of smoke. Avoid direct eye contact with “flash” of light from ignition of starting material. Avoid inhalation of smoke/fumes.

nVent ERICO Cadweld One Shot



Fig. 15 – Aiming the flint igniter from the side, ignite the starting material on the mold cover. Withdraw the igniter quickly to prevent fouling. Allow approximately 30 seconds for completion of the reaction and solidification of the molten material.



Fig. 17 – You are ready to make another Cadweld One Shot connection.

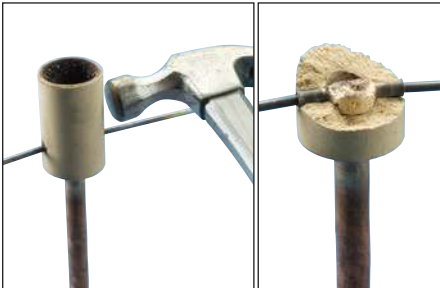

Fig. 16 – Break the ceramic Cadweld One Shot mold off of the connection. Avoid contact with hot materials. See the “nVent ERICO Cadweld Quality Standards” section to see whether a quality connection has been made.

nVent ERICO Cadweld Plus One Shot



Fig. 1 – Always wear protective safety glasses and gloves while working with Cadweld exothermic products.



Fig. 3 – Check to ensure the ceramic mold is not worn or broken, which could cause leakage of molten weld metal during the reaction.



Fig. 2 – Prepare the proper materials and equipment for the type of connection you are making. The Cadweld Plus One Shot system requires a Cadweld One Shot ceramic mold, Cadweld Plus welding material, wire brush for cleaning/preparing conductors, nVent ERICO Cadweld Plus Impulse Exothermic Welding Control Unit, and propane torch.

NOTE: Additional materials may be required for your specific application. Refer to your mold instructions.

Inspect the Cadweld Plus One Shot box label to ensure that it corresponds to the application, indicated by the:

1. Cadweld Plus One Shot part number
2. conductor size
3. welding material required
4. other materials required

The mold must be correct for the conductor size and application.

DO NOT MODIFY MOLDS.

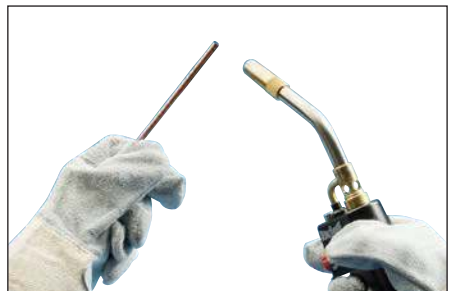

Fig. 4 – The conductors should be clean and dry before the connection is made. Use a propane torch to dry wire conductors and remove remaining cleaning residue, solvent, or water before making the Cadweld connection.

nVent ERICO Cadweld Plus One Shot

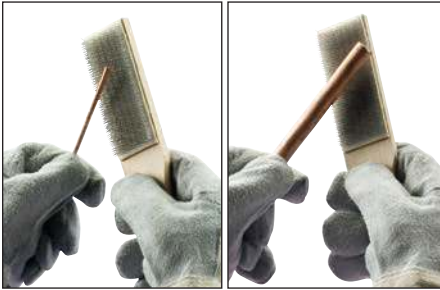

Fig. 5 – Next, use a wire brush to further prepare the surface of the conductors and ground rod (nVent ERICO T-313 or T-314 brush). Scrape the outer surface to remove dirt and oxidation. You will notice a slight color change.



Fig. 6 – Each Cadweld Plus One Shot contains a rubber grommet at the bottom of the mold. Place the mold onto the ground rod until the ground rod reaches the wire stopper and cannot go any further.

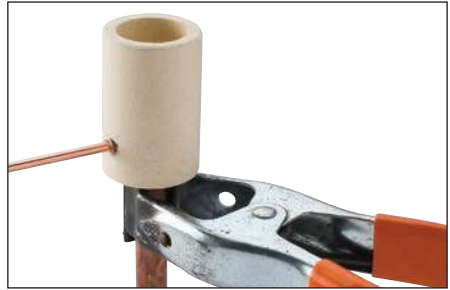

Fig. 7 – Insert the conductors and position them for the connection. To support the One Shot on the rod, use locking pliers or clamp B399P (sold separately).



Fig. 8 – Inspect the cup to ensure it is tightly sealed and the ignition strip is securely attached to the seal.



Fig. 9 – Place the welding material cup into the top of the mold. Make sure the ignition strip nests into the recess on the top edge.

nVent ERICO Cadweld Plus One Shot



Fig. 10 – Place the ceramic lid onto the mold.



Fig. 11 – nVent ERICO Cadweld Plus Impulse Exothermic Welding Control Unit.



Fig. 12 – Place the ignition strip into the control unit connector. Remove or protect fire hazards in close proximity to the connection. Advise nearby personnel of welding operations in the area.



Fig. 13 – Using the control unit, lift the trigger cover and press the ignition button and hold. You will see the 6 lights on the top of the control unit light up as it is charging. After the 6th light is illuminated, the control unit will send a charge to the ignition strip, initiating the Cadweld Plus exothermic reaction. Allow approximately 30 seconds for completion of the reaction and solidification of the molten material.



Fig. 14 – Remove and dispose of the used Cadweld Plus weld metal cup.

nVent ERICO Cadweld Plus One Shot



Fig. 15 – Break the ceramic Cadweld One Shot mold off of the connection. Avoid contact with hot materials. See the “nVent ERICO Cadweld Quality Standards” section to see whether a quality connection has been made.



Fig. 16 – You are ready to make another Cadweld connection.

nVent ERICO Cadweld Quality Standards

All Cadweld materials are produced to high standards under stringent quality control. All Cadweld connections are designed and tested using Cadweld molds, welding materials, and accessories.

In the absence of any standards, national or international, we cannot accurately predict the individual product standards of our competition, either known or unknown. Therefore, mixing of one manufacturer's molds with another manufacturer's welding materials can predictably lead to finished welds that do not meet the standards of either manufacturer. After all, one of the advantages of exothermic welding as a welding process is the fact that it is pre-engineered.

Specifications for Cadweld Connections

All grounding system connections shall be made by the Cadweld process. Connections shall include, but not be limited to, all cable to cable splices, T's, X's, etc.; all cable to ground rods, ground rod splices, cable to steel and cast iron; and cable lug terminations.

Procedures listed in all Cadweld instructions shall be followed. Molds shall not be altered in the field.

All materials used (molds, welding material, tools, accessories, etc.) shall be Cadweld materials, manufactured by nVent ERICO. Materials of different manufacturers shall not be mixed.

A Cadweld mold is designed to last for an average of 50 connections. This will vary according to the care given the mold during use.

CADWELD MOLD INSPECTION

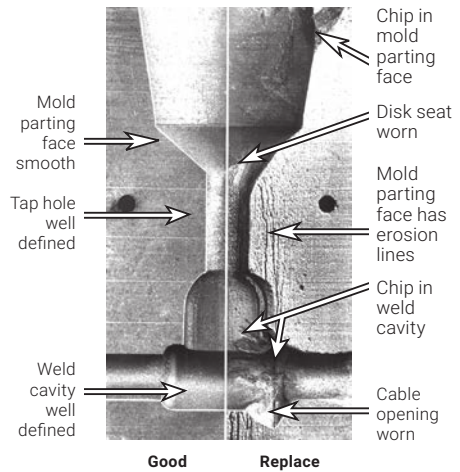

Inspect the mold regularly. Check the following items to determine if a mold should be replaced:

Cable Opening

- The conductor should fit snugly. A loose fit will cause leakage.
- The opening should not be chipped or worn.

Weld Cavity

- The cavity should be well defined.
- There should be no chips or gouges.

Tap Hole

- The tap hole should be well defined.

Disk Seat

- The seat should not be worn or chipped; the disk must seat properly.

Mold Parting Face

- The parting face should not be chipped.
- The parting face should always be cleaned properly. Use a clean shop towel or newspaper and wipe clean. Using a wire brush to clean the mold will cause erosion and quickly destroy the mold.

nVent ERICO Cadweld Quality Standards

INSPECTION OF CADWELD CONNECTIONS GENERAL INDICATORS

Proper inspection of a Cadweld connection relies on the judgment of the field personnel. Look closely at the size, color, surface finish, and porosity of the connection.

Following the guidelines below will assist in making meaningful inspections. Photographs of good, acceptable, and reject connections appear on pages 44-47.

Size

1. No portion of the conductor within the confines of the weld should be exposed.
2. Maximum depression under the riser on horizontal connections (after the slag has been removed) should be no lower than the top of the conductor.
 - A low fill indicates:
 - (a) Not enough welding material was used
 - (b) Excessive leakage of molten metal
 - (c) Improper positioning of the conductor inside the mold
 - (d) Movement of conductor
 - 3. Excessively high fill (tall riser) indicates:
 - (a) Too large welding material size was used (connection is still acceptable)
 - (b) Apparent volume increase due to contaminants in conductor or mold (see "Porosity" on page 42)

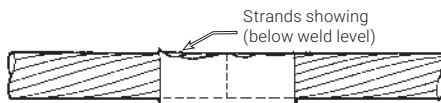

Unacceptable

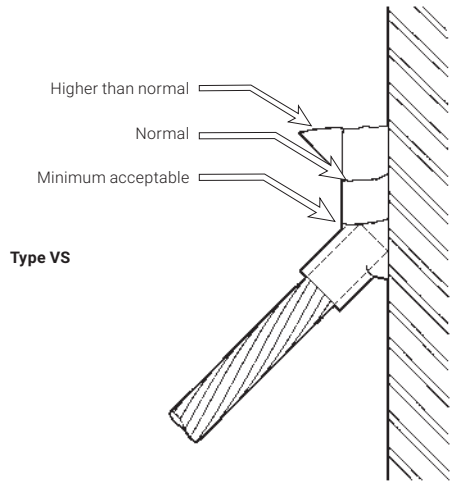

Type VS

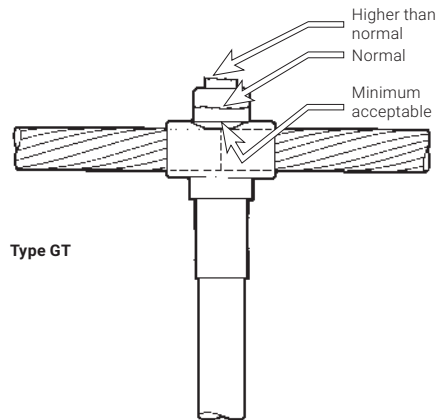

Type GT

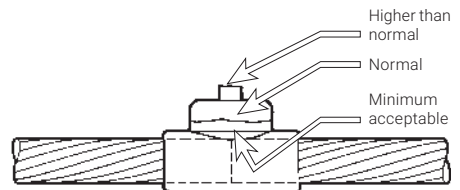

Type SS

nVent ERICO Cadweld Quality Standards

INSPECTION OF CADWELD CONNECTIONS GENERAL INDICATORS (CONTINUED)

Color

The color of a Cadweld connection is best seen after a light wire brushing of the connection. It should normally be gold to bronze in color. Occasionally, it may be silvery at the top. This silver color indicates “tin sweat” of the surface, a normal condition. A Cadweld connection to cast iron or galvanized surfaces is often silvery due to alloying with the metals.

Surface Finish

The surface of a Cadweld connection should be reasonably smooth and free of major slag deposits. If slag deposits cover more than 20% of the connection surface, or if any cable strands are exposed after slag has been removed, the connection must be rejected.

Porosity

The connection should be essentially free from porosity. Excessive porosity is normally the result of contaminants (water, oil, dirt, etc.) in the conductor and/or mold. A few small pinholes may be present on the surface of the riser. The depth of a pinhole must never extend beyond the center of the conductor. To check the depth, probe the pinhole with a 1/32-in.-diameter wire (paper clip). Reject the connection if the depth of the pinhole extends beyond the center of the conductor.

INSPECTION OF CADWELD CONNECTIONS VISUAL INSPECTION

Photographic Guides

Like all electrical connections, a visual inspection is no guarantee of performance. Crimped or bolted connections cannot be inspected visually, but Cadweld connections can be visually inspected and provide an indication of the quality of the weld. Visual inspection is recommended as a practical minimum.

Use the photographs on the following pages as a guide to visual inspection. Cadweld connections are normally rated as good, acceptable or reject.

A **good** connection is a normal weld with only minor surface imperfections.

An **acceptable** connection is a less than normal weld, but a good performing weld. Imperfections indicate that 1) a new mold is required, 2) a change in procedure is necessary, or 3) the proper mold conductor and/or welding material should be used.

A **reject** connection shows inadequate fill or an extra high riser due to 1) use of incorrect procedure, 2) use of incorrect equipment and/or equipment worn beyond its useful life, or 3) use of incorrect material.

nVent ERICO Cadweld Quality Standards

INSPECTION OF CADWELD CONNECTIONS PHOTOGRAPHIC GUIDES



Good.

A solid weld with only minor surface imperfections.



Acceptable.

The presence of water/moisture in conductor strands or mold indicates that one or both were not properly dried. Although the riser is porous, the weld is solid. The degree of porosity is not sufficient to reject this connection.



Acceptable.

Fill is lower than normal, but still sufficient.



Reject.

Extreme amounts of slag on surface are caused by welding material leaking past disk or complete lack of disk. Inspect the condition of mold disk seat and check disk positioning prior to making the next connection.



Reject.

A worn or incorrect mold was used, allowing leakage around conductor. The fill in this connection is insufficient to allow it as acceptable. Replacement of mold is required prior to making next connection.



Reject.

Excessive water in cable strands and/or mold.

nVent ERICO Cadweld Quality Standards

INSPECTION OF CADWELD CONNECTIONS PHOTOGRAPHIC GUIDES (CONTINUED)



Reject.

Light carbon traces on cable and connection are evidence of oil on cable strands. Oily cables must be cleaned with safety solvent.



Reject.

Fill too low. Weld cavity was not filled over cable strands. "Fins" indicate that the mold was not closed tightly due to incorrect mold, incorrectly adjusted handle clamp, or presence of foreign material in mold parting line. Before making the next connection, check the mold for each of the above.



Reject.

Heavy carbon coating on cable and connection is evidence of large amounts of oil or grease on cable. Cable must be cleaned with safety solvent.



Reject.

Fill too low. Weld cavity was not filled over cable strands. Absence of leakage indicates that welding material size was incorrect (too small) or thru conductor moved.

nVent ERICO Cadweld Quality Standards

FIELD SITUATION GUIDE

Most field difficulties can be overcome by checking the following problems.

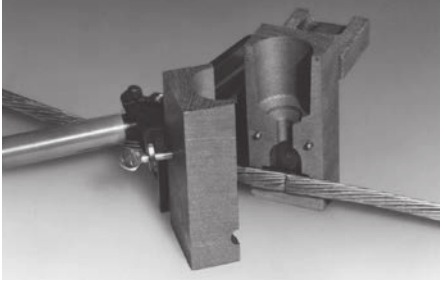

PROBLEM A

The mold doesn't close tightly.

Check for:

1. Adjustment of handle clamps
2. Cables out of round or bent
3. Dirt or slag in mold parting line
4. Correct cable size

NOTE: Use "C" clamp if necessary

PROBLEM B

The connection is covered with excessive slag.

Check for:

1. Welding material leaking past the disk, caused by:
 - (a) Chipped graphite at tap hole
 - (b) Disk moved when welding material was dumped
 - (c) Disk not properly seated
 - (d) Disk was not installed

NOTE: A small amount of slag on the surface is not abnormal

PROBLEM C

Molten metal "spits" out of the crucible when making a connection.

Remedy:

1. See Problem D.

PROBLEM D

The connection is porous

Check for:

1. Presence of moisture either in conductor or mold.

Remedy:

- (a) Dry the conductor by wiping and heating
- (b) Heat mold with torch (to above 212°F) or by igniting welding material in mold without any conductors, taking care to prevent burns from the hot material running out of the mold

NOTE: Do not use the second method of heating if the mold has wear plates

Check for:

2. Other contaminants (oil, insulation, etc.) present in conductors.

Remedy:

- (a) Use a safety solvent to wash the conductor, then dry it
- (b) If insulation is present between strands, remove it

Check for:

3. Mold packing material in weld cavity of mold.

Remedy:

- (a) Always apply mold packing material to conductor after mold is closed

nVent ERICO Cadweld Quality Standards

Field Situation Guide (continued)

PROBLEM E

The conductors do not weld

Check for:

1. Conductors were not properly cleaned and dried.

Remedy:

- (a) Remove oxides with a wire brush. If heavily oxidized, have fresh-cut conductor end and use Cadweld Heavy Duty molds
- (b) Dry conductors with a torch

Check for:

2. Conductors not properly positioned in the mold.

Remedy:

- (a) Check for proper gap or butting as required (see the mold tag and read the instructions packaged with mold)
- (b) Check to be sure gap is centered under tap hole

NOTE: In some cases, the run (thru) conductor must be cut and gapped. Follow instructions for same or use Cadweld Heavy Duty molds.

PROBLEM F

The welding material leaks around the conductor.

Remedy:

1. Use packing material around the conductor after the mold is closed.
2. Use molds with wear plates (which also act as chill plates).

3. Check for the proper mold. Mold must be sized for the cable being welded.
4. If the mold is excessively worn, replace with a new mold.

PROBLEM G

The connection has “fins”— metal is lost.

Check for:

1. Mold not completely closed.
2. Mold worn beyond useful life and needs replacement.

PROBLEM H

The cables pull out of the mold during welding.

Remedy:

1. Use a clamp (Cadweld B-265) or other means to prevent movement of conductors when welding.

PROBLEM I

Insufficient fill material to cover conductors

Check for:

1. Use of proper welding material size (see mold tag).
2. Too large a gap between conductors (see positioning instructions).
3. Mold leakage.

Remedy:

- (a) See Problem F
 - (b) See Problem G
 - (c) See Problem H
4. Conductor movement.

nVent ERICO Cadweld Quality Standards

Field Situation Guide (continued)

PROBLEM J

The riser is too high.

Check for:

1. Use of proper welding material size (see mold tag).
2. Moisture in mold or conductor.

Remedy:

- (a) See Problem D

PROBLEM K

The mold wears out quickly.

(Molds should produce an average of 50 connections.)

Remedy:

1. Use Cadweld B-265 cable clamp for hard-drawn copper or DSA Copperweld®.
2. Clean the mold with a soft brush, clean cloth, or newspaper. DO NOT USE A WIRE BRUSH.
3. Use care in removing the mold from a finished connection to prevent chipping of mold.

PROBLEM L

When welding to steel, the weld does not “stick” to the steel.

Remedy:

1. Clean the steel with a rasp or grinder to bright metal. When grinding, use an nVent ERICO approved grinding wheel only. All mill scale, paint, and/or other coating must be removed. Wire brushing will NOT suffice. Grease must be removed with safety solvent before cleaning.

2. Clean galvanized surfaces with a wire brush or emery cloth. However, extra heavy galvanized steel must be cleaned with a rasp.
3. If the steel is moist, heat with a torch (from the back side if possible). Any carbon deposit from the flame must be removed.
4. If conductors are not in proper position, check the instruction sheet.

PROBLEM M

When welding to ductile iron or cast iron, the weld does not “stick” to the surface.

Remedy:

1. Remove all coatings before cleaning.
2. Clean the surface with a rasp or grinder to bright metal. When grinding, use an nVent ERICO-approved wheel only.
3. Clean the surface with a safety solvent after grinding or rasping.
4. Use Cadweld XF-19 alloy welding material (orange cap).

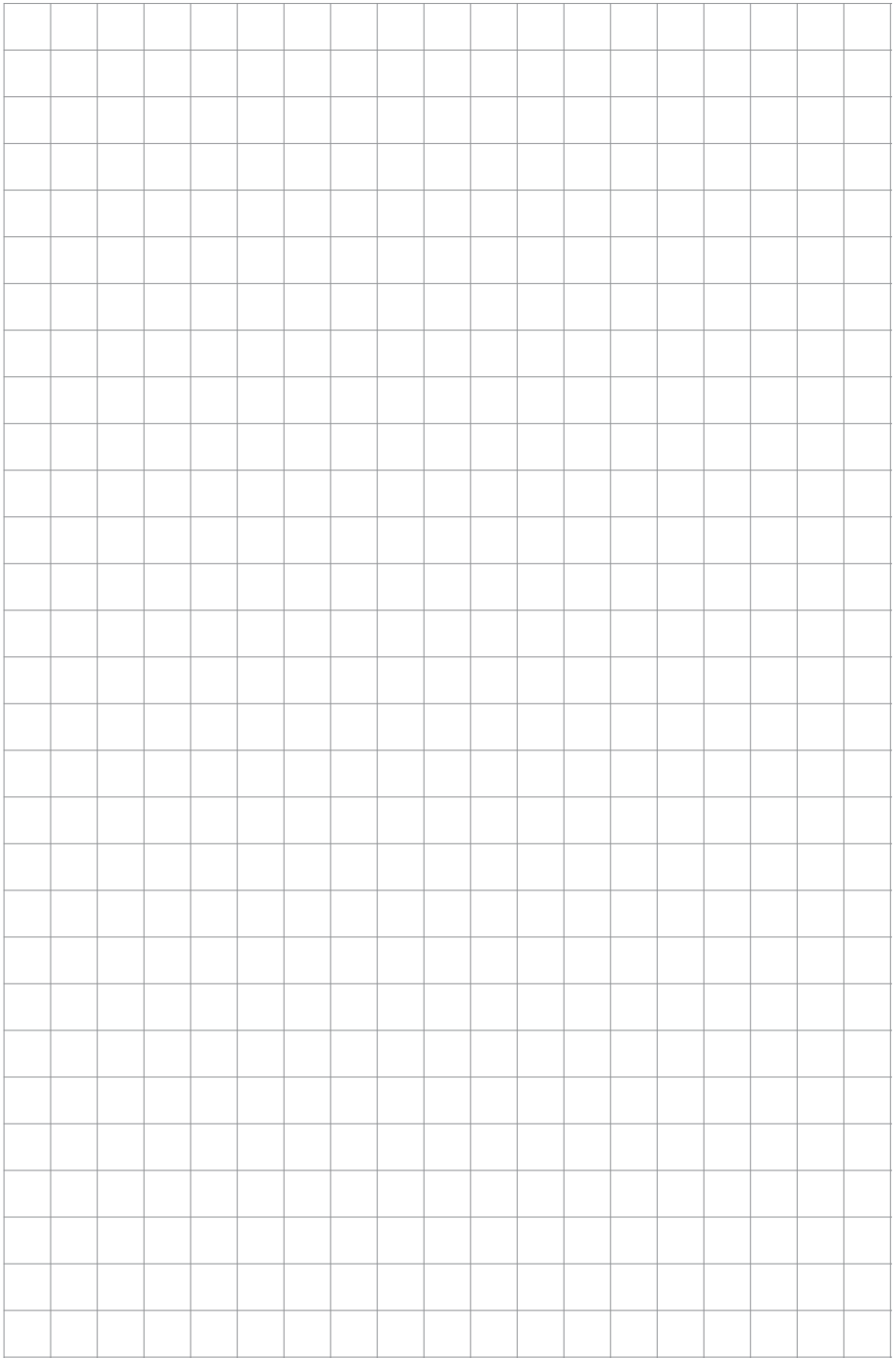

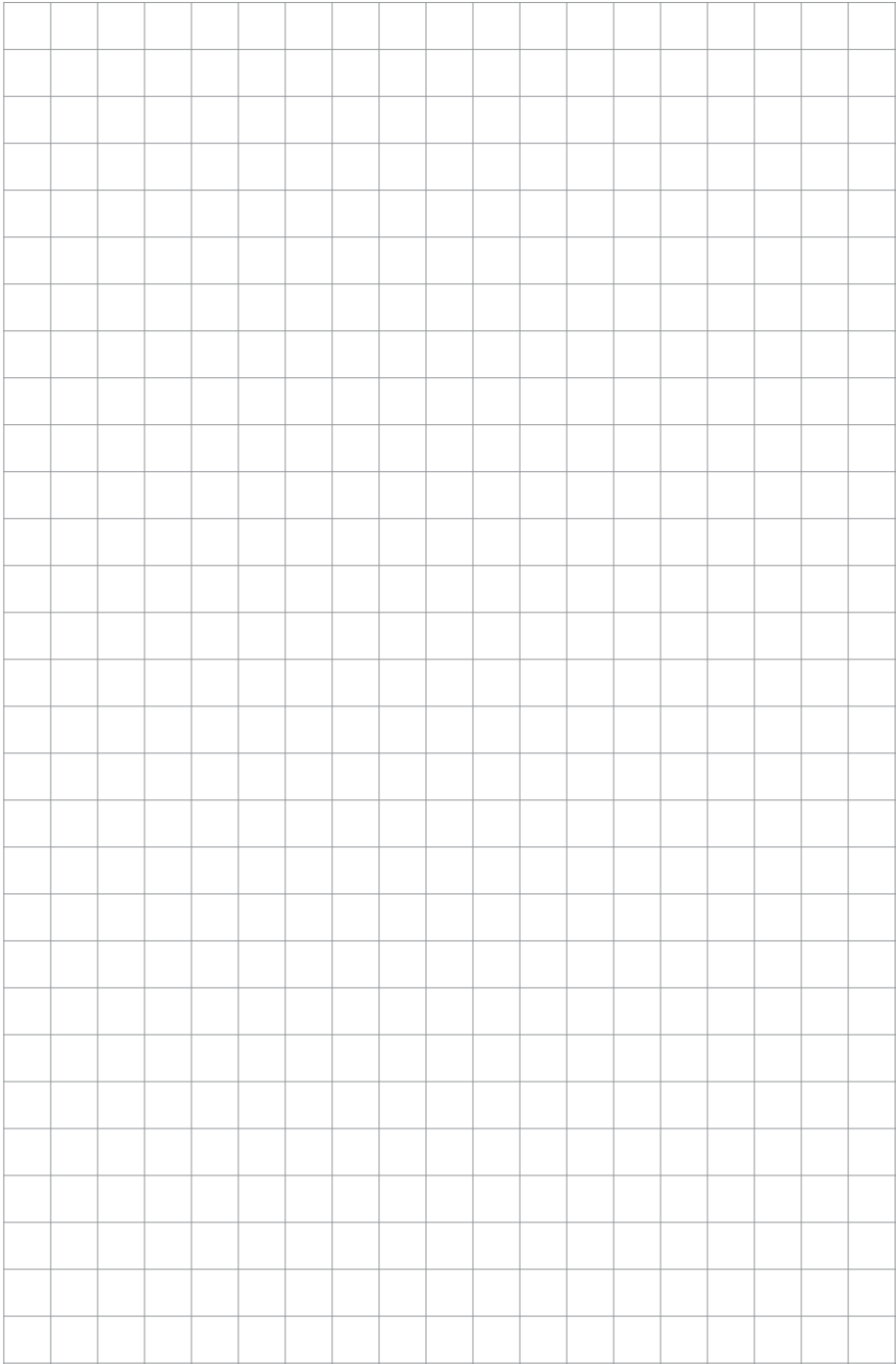

Our powerful portfolio of brands:

CADDY ERICO HOFFMAN RAYCHEM SCHROFF TRACER



[Cadweld.com](https://www.cadweld.com)

©2021 nVent. All nVent marks and logos are owned or licensed by nVent Services GmbH or its affiliates. All other trademarks are the property of their respective owners. nVent reserves the right to change specifications without notice.

ERICO-TH-E1294W-CadweldIIIGuide-UKEN-2111