



The FieldSET OTi100W is an efficient, dimmable, linear LED driver for outdoor applications. This programmable driver is compatible with the FieldSET LED Driver Programming Tool which provides visual and audible feedback programming. The FieldSET OTi100W is designed for in-field programming and replacement.

Driver Overview

- Intended for use in LED fixtures including Industrial, High-bay, Outdoor, and Cobra-head fixtures.
- 100W Output
- 0-10V Dimming with 10% Minimum Dim Level
- IP66 Rated

General Information

Driver Description	100W Outdoor 120-277V; 0-10V, 10% min dim
Type	Constant Current
Output Power	100W (Max.)
Programming Tool	FieldSET LED Driver Programming Tool
Field Programmable Features	Output Current Dimming Level

Environmental Specifications

Ambient Operating Temperature	-40°C to 55°C
Max. Case Temperature (Tc)	85°C ¹ 90°C (Max.)
Max. Storage Temp.	70°C
Max. Relative Humidity (%)	95% non-condensing
Transient Protection	ANSI C82.77-5 Cat C Low 6.0kV
UL Environmental Rating	Dry and Damp, Type HL
UL File number	E320395
IP Rating	IP66
EMI Compliance	FCC Part 15 Class A
Sound Rating	Class A

¹ 5 year warranty applicable at 85°C

Electrical Specifications

Input

Input Voltage (VAC)	120V-277V (+/-10%)	
Frequency Range (Hz)	50-60 Hz (+/-) 10%	
	120V	277V
Input Current (A)	0.95	0.40
THD @ Full load	<10%	<10%
Power Factor @ Full load	>0.95%	>0.95%
Efficiency @ Full load	≥88%	≥90%
Inrush Current (Apk) ²	38A, 315µs	95A, 276µs

Output

Output Current (mA)	600-1250mA (1mA); 700mA default
Output Voltage (VDC)	30-100VDC
Output Ripple Current	<25% @1250mA
Max. Output Power (W)	100W
LED Power-Up Time	<1 sec
Load Regulation	<5%
Line Regulation	<5%
Over Voltage Protection	Yes, non-latching
Over Load Protection	Power fold back @105W
Output Short-Circuit Protection	Yes, non-latching
Over Temperature Protection	Yes, Foldback at 100°C, Auto recovery

Dimming

Dimming Control	0-10V (Isolated) ¹ AstroDim
Dimming Range	10-100% (50mA min)
Dimming Type	Analog
Source/Sink Current	0.9mA

CAUTION: Two power supplies if dimming is connected to non-class 2 circuit.
¹ Class 2 or non-Class 2 wiring allowed.



FIELDSET OTi100W LED Driver - Technical Specifications

Wiring Diagram

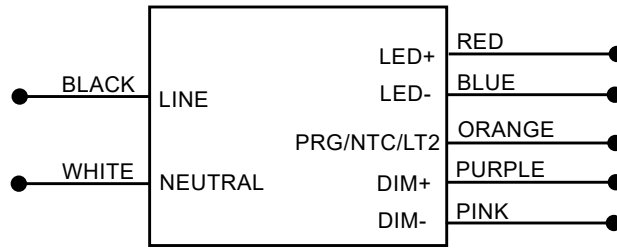

NOTES:

Maximum remote mounting distance is 16 feet.

The Dimming input is isolated and will allow Class 2 or non-Class 2 wiring across Purple and Gray wires.

Mechanical Diagram

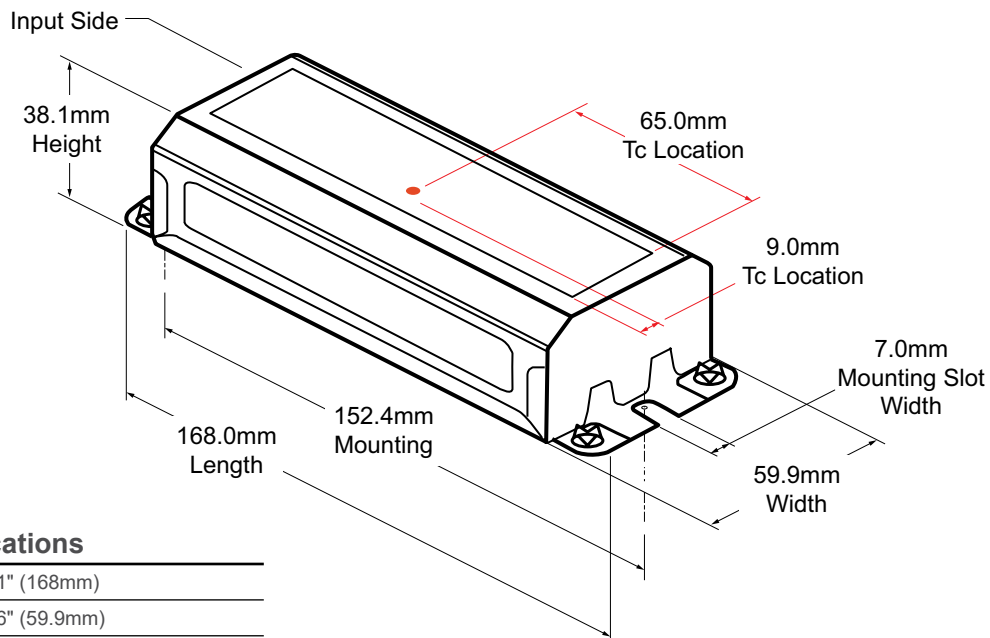

Mechanical Specifications

Length	6.61" (168mm)
Width	2.36" (59.9mm)
Height	1.5" (38.1mm)
Mounting Length	6.0" (152.4mm)
Mounting Slot Width	0.28" (7mm)

Inrush Characteristic

Vin (V)	Ipeak (A)	T(@ 10% of Ipeak)
120	38	315µs
277	95	276µs

Complies to NEMA 410 inrush current requirements.

FIELDSET OTi100W LED Driver - Technical Specifications

Ordering Information

Series	Driver Type	Wattage	Input Voltage	Output Current	Control	IP Rating	Programmer
FieldSET	OTi	100W	UNV	1250C	2DIM	P6	FS

Understanding Your Driver Model			
FieldSET	Field Service Solution	1250C	1250mA Output (600-1250mA output range)
OTi	OTi Intelligent Driver	2DIM	0-10V Dimming plus Astro Dim
100W	100W Output	P6	IP66 Rating
UNV	120-277VAC Input	FS	Programmed using FieldSET Programmer Tool

Product Description	UPC
FIELDSET OTi 100W UNV 1250C 2DIM P6 FS	197589480306
FIELDSET OT 100W UNV 1250C 2DIM P6 FS J20	196183325389

Warranty

FieldSET and OPTOTRONIC® by eldoLED Products are covered by a 5-year limited warranty. This is the only warranty provided and no other statements in this specification sheet create any warranty of any kind. All other express and implied warranties are disclaimed. Complete warranty terms can be found at: www.eldoled.com/legal/terms-and-conditions

Note: Actual performance may differ as a result of end-user environment and application. Specifications subject to change without notice.