

Twist-Lock® Devices



**20 Amp, 3ØY 120/208, 277/480 and 347/600 Volts AC
4 Pole, 5 Wire, Grounding**



20A 3ØY 120/208V AC NEMA L21-20R 2 HP	20A 3ØY 277/480V AC NEMA L22-20R 5 HP	20A 3ØY 347/600V AC NEMA L23-20R
---	---	-------------------------------------

Connector Bodies

Watertight Safety-Shroud®

IP66 SUITABILITY UL Type 4x, 12

Description	Cord Dia.	Catalog Number		
Black Valox® housing, white Valox® clamps.	.350"-1.150" (9-29)	HBL2513SW	-	-

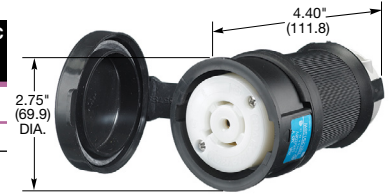

Insulgrip®

IP20 SUITABILITY

Description	Cord Dia.	Catalog Number			
Black and white nylon.	.350"-1.150" (9-29)	HBL2513	HBL2523	HBL2533	
Black and white nylon, spring termination	.350"-1.150" (9-29)	HBL2513ST	HBL2523ST	-	
Spring termination, all black		HBL2513STBK	-	-	
All black nylon.	.350"-1.150" (9-29)	HBL2513BK	-	-	
Corrosion resistant, yellow nylon.	.350"-1.150" (9-29)	HBL25CM13	-	-	
Black and white for flat cable.	.350"-1.150" (9-29)	HBL2513FC	-	-	



Note: See page B-52 for accessories.

Receptacles

Watertight Safety-Shroud®

IP66 SUITABILITY UL Type 4x, 12

Description	Catalog Number		
Gray Valox® housing and flange, back wired.	HBL2510SW	-	-

Note: See page B-54 for accessories.

Safety-Shroud® Twist-Lock®

IP20 SUITABILITY

Description	Catalog Number		
Gray Valox® angle housing, one gang, back wired.	HBL2510AR	-	-
Gray Valox® surface mounting, one gang, back wired.	HBL2510SR	-	-
Gray Valox® semi-flush, two gang, back wired.	HBL2510SR2	-	-

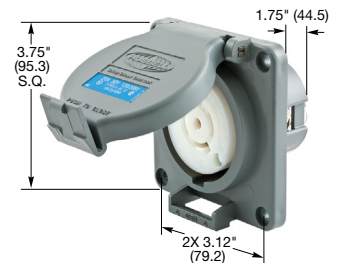

Single Flush Receptacles

IP20 SUITABILITY

Description	Catalog Number			
Black nylon face, back and side wired.	HBL2510	HBL2520*	HBL2530*	
Black and white nylon, spring termination.	HBL2510ST	HBL2520ST	-	
Isolated ground, orange nylon face, back and side wired.	IG2510	-	-	

Note: See page B-52 for accessories.

*Not Fed Spec.

Insulgrip® Flanged Receptacles

Description	Catalog Number			
Nylon casing, back wired.	HBL2516	HBL2526	HBL2536	
Nylon casing, back wire, spring termination	HBL2516ST	HBL2526ST	-	
Black nylon casing, back wire, spring termination	HBL2516STBK	-	-	

Note: See page B-52 for accessories.

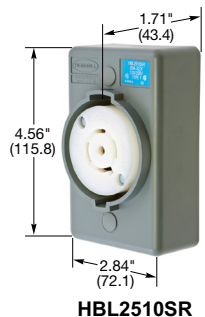
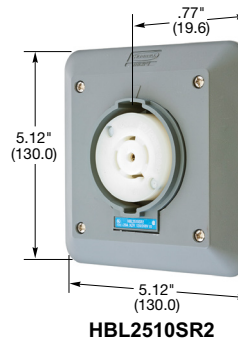
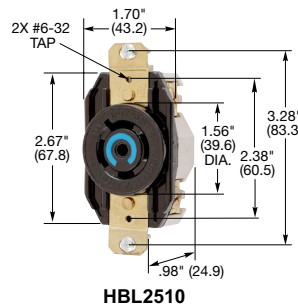
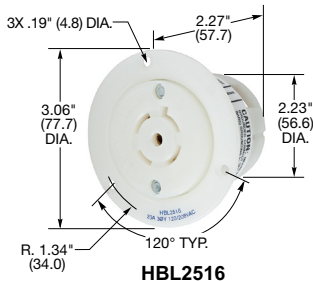
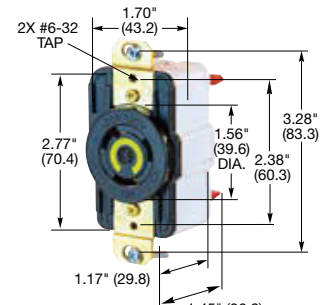

Valox® is a trademark of SABIC Innovative Plastics, acquired from General Electric Company.

Dimensions in Inches (mm)