

ERL1 Cobra Head LED Roadway Lighting

The Evolve® LED Roadway ERL1 Luminaire is optimized utilizing advanced LED reflective optical system for local, collector and major roadway. The modern design incorporates the heat sink directly into the unit for heat transfer to prolong LED life. The ERL1 is available with legacy NEMA/ANSI 7-Pin receptacle and/or Zhaga Book 18 receptacle for easy integration with asset management devices and sensors.



Construction

Housing:	Aluminum die cast enclosure Standard Tool-less entry Integral heat sink for maximum heat transfer
Lens:	Impact resistant tempered glass Visual Comfort Lens available
Paint:	Corrosion resistant powder paint, minimum 2.0 mil thickness (RAL & custom colors available) Standard = Gray, Black and Dark Bronze Optional = Coastal Finish
Weight:	12.4 lb (5.6 kg)

Optical System

Lumens:	2604 - 15,700
Distribution:	Type II, III, IV, and Type II Enhanced Backlight
Efficacy (LPW):	up to 163
CCT (K):	2700, 3000, 4000
CRI (MIN):	≥70

Electrical

Input Voltage (V):	120-277 or 347-480
Input Frequency (Hz):	50/60
Power Factor:	≥ 0.9 at rated watts ^
Total Harmonic Distortion:	≤ 20% at rated watts

^ For 03 lumen code, pf@277V=0.89 and THD@480>20%

Surge Protection*

STANDARD	OPTIONAL
10kV/5kA	Secondary 10kV/5kA (R Option) or Secondary 20kV/10kA (T Option)

*Per ANSI C136.2-2023



Lumen Maintenance

Projected Lxx per IES TM-21-11 at 25°C

LUMEN CODES	LXX (≥10K) @ HOURS (70 CRI)			
	25,000 HR	50,000 HR	75,000 HR	100,000 HR
03-07	92	90	88	81
08-10	97	95	94	90
11-13	96	93	92	87
14	96	92	91	85
15	97	96	96	--
16	97	96	96	--

Note: Projected Lxx based on LM80 (≥ 10,000 hour testing). Accepted industry tolerances apply to initial luminous flux and lumen maintenance measurements.

Ratings

Operating Temp:	-40°C to 50°C
Vibration:	3G per ANSI C136.31-2018
LM-79:	Testing in accordance with IES Standards
EMI:	Title 47 CFR Part 15 Class A
RoHS:	Complies with the material restrictions of RoHS

Controls

Dimming:	Standard-0-10V Optional-DALI D4i (Option U4)
Sensors:	Photo Electric Sensors (PE) available LightGrid Compatible Zhaga Book 18 Sensor Compatible

Warranty

5 Year (Standard)

10 Year (Optional)

Ordering Information

ERL1

PROD. ID	VOLTAGE	LUMEN CODE	DISTRIBUTION ¹	CCT	RECEPTACLES ²	COLOR	OPTIONS
E = Evolve	O = 120-277V ⁶	03 ¹²	Standard Glass	27 = 2700K 70 CRI	Top Only	GRAY = Gray	A = 4 Bolt Slipfitter
R = Roadway	H = 347-480V ⁶	04	A7 = Type II Narrow	30 = 3000K 70 CRI	1 = Top: None	BLCK = Black	C1 = Captive Door
L = Local		05	B7 = Type II	40 = 4000K 70 CRI	A = Top: ANSI 7-Pin ^{3,4}	DKBZ = Dark Bronze	F = Fusing ^{6,8,11}
1 = Single Module		06	C7 = Type III	28 = 2700K 80 CRI ¹³	D = Top: ANSI 7-Pin w/ Shrt Cap ^{3,4}		G = Internal Bubble Level
		07	D7 = Type IV	38 = 3000K 80 CRI ¹³	E = Top: ANSI 7-Pin w/ Long Life PE ^{3,4}		I = IP66 Optical
		08	E7 = Type II Enhanced Back Light	48 = 4000K 80 CRI ¹³			M1 = Magnapak (23 units/box) ⁷
		09					R = 10kV/5kA Secondary SPD
		10	Visual Comfort Lens		Top & Bottom		T = 20kV/10kA Secondary SPD ⁸
		11	J7 = Type II Narrow		G = Top : ANSI 7-Pin +Bottom: Zhaga Book 18 ⁵		U4 = DALI D4i ^{3,4,5,9,11}
		12	K7 = Type II		H = Top : ANSI 7-pin w/Shrt Cap + Bottom: Zhaga Book 18 ⁵		V1 = Field Adjustable Module ⁹
		13	L7 = Type III		J = Top: ANSI 7-Pin w/ Long Life PE + Bottom: Zhaga Book 18 ⁵		Y = Coastal Finish ¹⁰
		14	M7 = Type IV		Z = Top: None+ Bottom: Book 18 ⁵		D1 = BABA Compliant request ¹⁴
	15	N7 = Type II Enhanced Back Light				XXX = Special Options	
	16					Single Pack box are standard	
	Select Single V ONLY if Fusing Selected 1 = 120V 2 = 208V 3 = 240V 4 = 277V 5 = 480V D = 347V						

- Nominal IES Type classing subject to typical variation, individual units may differ, review IES files for individual sku typing.
- 7-Pin receptacle per ANSI C136.41 and/or 4-Pin receptacle per Zhaga Book 18.
- 7 Pin receptacle wired for 0-10V control unless Dali (U4) selected.
- If U4 option is selected and A, D or E (7-Pin) receptacle option is selected, the D4i driver is configured with the DALI Integrated Power BUS enabled. Contact factory if DALI is desired with Integrated Power BUS disabled.
- When ordering Zhaga Book 18 receptacle, Dali-D4i (Option U4) must be selected. DALI control BUS Powered.
- Fusing not available with multivolt (O or H) Input Voltages.
- Option M1 provides for multiple fixtures in single palletized container. Single Pack box is standard.
- Secondary 20kV SPD (Option T) may not be available with Fusing (Option F). Contact factory if required.
- Field Adjustable Module (option V1) not available with Dali (Option U4).
- Coastal Finish (option Y) is recommended for installations within 750 feet from coast. Lead time varies, check with factory.
- Fusing may not be available with 347V or 480V if Dali (Option U4) is requested. Contact factory if required.
- DLC not available for "O" or "H" Input Voltage of 03 lumen code.
- If 80 CRI is selected use multipliers on page 6 to determine lumens.
- BABA compliant configurations available. D1 must be placed at the end of ordering nomenclature. Please contact factory to verify if specific configuration is compliant.

Suggested HID Replacement

Approximately 3,000 lumens to replace 50W-70W HPS Cobra-head
 Approximately 4,000-5,000 lumens to replace 100W HPS Cobra-head
 Approximately 7,000-9,000 lumens to replace 150W HPS Cobra-head
 Approximately 9,000-12,000 lumens to replace 200W HPS Cobra-head
 Approximately 12,000-16,000 lumens to replace 250W HPS Cobra-head

Note: Actual replacement lumens may vary based upon mounting height, pole spacing, design criteria, etc.

CUSTOMER NAME _____

PROJECT NAME _____

DATE _____ TYPE _____

CATALOG NUMBER _____

LUMEN CODE	DISTRIBUTION	TYPICAL INITIAL LUMENS (70 CRI)			TYPICAL WATTAGE		LPW*	BUG RATINGS (70 CRI)		
		4000K	3000K	2700K	120-277V	347-480V		4000K	3000K	2700K
03	A7	3000	2900	2800	20	23	163	B1-U0-G1	B1-U0-G1	B1-U0-G1
	B7							B1-U0-G1	B1-U0-G1	B1-U0-G1
	C7							B1-U0-G1	B1-U0-G1	B1-U0-G1
	D7							B1-U0-G1	B1-U0-G1	B1-U0-G1
	E7							B1-U0-G1	B1-U0-G1	B1-U0-G1
	J7	2790	2697	2604			152	B1-U0-G1	B1-U0-G1	B1-U0-G1
	K7							B1-U0-G1	B1-U0-G1	B1-U0-G1
	L7							B1-U0-G1	B1-U0-G1	B1-U0-G1
	M7							B1-U0-G1	B1-U0-G1	B1-U0-G1
	N7							B1-U0-G1	B1-U0-G1	B1-U0-G1
04	A7	4000	3900	3700	27	30	161	B1-U0-G1	B1-U0-G1	B1-U0-G1
	B7							B1-U0-G1	B1-U0-G1	B1-U0-G1
	C7							B1-U0-G1	B1-U0-G1	B1-U0-G1
	D7							B1-U0-G1	B1-U0-G1	B1-U0-G1
	E7							B1-U0-G1	B1-U0-G1	B1-U0-G1
	J7	3720	3627	3441			150	B1-U0-G1	B1-U0-G1	B1-U0-G1
	K7							B1-U0-G1	B1-U0-G1	B1-U0-G1
	L7							B1-U0-G1	B1-U0-G1	B1-U0-G1
	M7							B1-U0-G1	B1-U0-G1	B1-U0-G1
	N7							B1-U0-G1	B1-U0-G1	B1-U0-G1
05	A7	5000	4800	4600	34	37	158	B1-U0-G1	B1-U0-G1	B1-U0-G1
	B7							B1-U0-G1	B1-U0-G1	B1-U0-G1
	C7							B1-U0-G1	B1-U0-G1	B1-U0-G1
	D7							B1-U0-G1	B1-U0-G1	B1-U0-G1
	E7							B1-U0-G1	B1-U0-G1	B1-U0-G1
	J7	4650	4464	4278			147	B1-U0-G1	B1-U0-G1	B1-U0-G1
	K7							B1-U0-G1	B1-U0-G1	B1-U0-G1
	L7							B1-U0-G1	B1-U0-G1	B1-U0-G1
	M7							B1-U0-G1	B1-U0-G1	B1-U0-G1
	N7							B1-U0-G1	B1-U0-G1	B1-U0-G1
06	A7	6000	5800	5500	42	45	154	B2-U0-G2	B2-U0-G2	B2-U0-G2
	B7							B1-U0-G1	B1-U0-G1	B1-U0-G1
	C7							B1-U0-G2	B1-U0-G2	B1-U0-G2
	D7							B1-U0-G2	B1-U0-G2	B1-U0-G2
	E7							B2-U0-G2	B2-U0-G2	B2-U0-G2
	J7	5580	5394	5115			143	B2-U0-G1	B1-U0-G1	B1-U0-G1
	K7							B1-U0-G1	B1-U0-G1	B1-U0-G1
	L7							B1-U0-G2	B1-U0-G2	B1-U0-G2
	M7							B1-U0-G2	B1-U0-G1	B1-U0-G1
	N7							B2-U0-G2	B2-U0-G2	B2-U0-G1

* LPW based on 120-277 V, 0-10 V dimming, 4000K CCT, & 70 CRI (utilizing non-rounded lumens & watts)

CUSTOMER NAME _____

PROJECT NAME _____

DATE _____ TYPE _____

CATALOG NUMBER _____

LUMEN CODE	DISTRIBUTION	TYPICAL INITIAL LUMENS (70 CRI)			TYPICAL WATTAGE		LPW*	BUG RATINGS (70 CRI)		
		4000K	3000K	2700K	120-277V	347-480V		4000K	3000K	2700K
07	A7	7000	6700	6400	49	52	149	B2-U0-G2	B2-U0-G2	B2-U0-G2
	B7							B1-U0-G2	B1-U0-G2	B1-U0-G1
	C7							B1-U0-G2	B1-U0-G2	B1-U0-G2
	D7							B1-U0-G2	B1-U0-G2	B1-U0-G2
	E7							B2-U0-G2	B2-U0-G2	B2-U0-G2
	J7	6510	6231	5952			139	B2-U0-G2	B2-U0-G1	B2-U0-G1
	K7							B1-U0-G2	B1-U0-G2	B1-U0-G1
	L7							B1-U0-G2	B1-U0-G2	B1-U0-G2
	M7							B1-U0-G2	B1-U0-G2	B1-U0-G2
	N7							B2-U0-G2	B2-U0-G2	B2-U0-G2
08	A7	8000	7600	7100	57	148	B2-U0-G2	B2-U0-G2	B2-U0-G2	
	B7						B2-U0-G2	B2-U0-G2	B1-U0-G2	
	C7						B1-U0-G2	B1-U0-G2	B1-U0-G2	
	D7						B1-U0-G2	B1-U0-G2	B1-U0-G2	
	E7						B2-U0-G2	B2-U0-G2	B2-U0-G2	
	J7	7440	7068	6603		137	B2-U0-G2	B2-U0-G2	B2-U0-G2	
	K7						B2-U0-G2	B2-U0-G2	B1-U0-G2	
	L7						B2-U0-G2	B1-U0-G2	B1-U0-G2	
	M7						B1-U0-G2	B1-U0-G2	B1-U0-G2	
	N7						B2-U0-G2	B2-U0-G2	B2-U0-G2	
09	A7	9000	8600	7900	65	144	B2-U0-G2	B2-U0-G2	B2-U0-G2	
	B7						B2-U0-G2	B2-U0-G2	B1-U0-G2	
	C7						B1-U0-G2	B1-U0-G2	B1-U0-G2	
	D7						B1-U0-G2	B1-U0-G2	B1-U0-G2	
	E7						B2-U0-G2	B2-U0-G2	B2-U0-G2	
	J7	8370	7998	7347		134	B2-U0-G2	B2-U0-G2	B2-U0-G2	
	K7						B2-U0-G2	B2-U0-G2	B2-U0-G2	
	L7						B2-U0-G2	B2-U0-G2	B2-U0-G2	
	M7						B1-U0-G2	B1-U0-G2	B1-U0-G2	
	N7						B2-U0-G2	B2-U0-G2	B2-U0-G2	
10	A7	10000	9600	8800	73	143	B2-U0-G2	B2-U0-G2	B2-U0-G2	
	B7						B2-U0-G2	B2-U0-G2	B2-U0-G2	
	C7						B2-U0-G2	B2-U0-G2	B1-U0-G2	
	D7						B1-U0-G2	B1-U0-G2	B1-U0-G2	
	E7						B3-U0-G3	B2-U0-G2	B2-U0-G2	
	J7	9300	8928	8184		133	B2-U0-G2	B2-U0-G2	B2-U0-G2	
	K7						B2-U0-G2	B2-U0-G2	B2-U0-G2	
	L7						B2-U0-G2	B2-U0-G2	B2-U0-G2	
	M7						B2-U0-G2	B2-U0-G2	B1-U0-G2	
	N7						B2-U0-G2	B2-U0-G2	B2-U0-G2	

* LPW based on 120-277 V, 0-10 V dimming, 4000K CCT, & 70 CRI (utilizing non-rounded lumens & watts)

CUSTOMER NAME _____

PROJECT NAME _____

DATE _____ TYPE _____

CATALOG NUMBER _____

LUMEN CODE	DISTRIBUTION	TYPICAL INITIAL LUMENS (70 CRI)			TYPICAL WATTAGE	LPW*	BUG RATINGS (70 CRI)		
		4000K	3000K	2700K			4000K	3000K	2700K
11	A7	11000	10500	9700	82	139	B3-U0-G3	B3-U0-G3	B2-U0-G2
	B7						B2-U0-G2	B2-U0-G2	B2-U0-G2
	C7						B2-U0-G2	B2-U0-G2	B2-U0-G2
	D7						B2-U0-G2	B2-U0-G2	B1-U0-G2
	E7						B3-U0-G3	B3-U0-G3	B3-U0-G3
	J7	10230	9765	9021		129	B2-U0-G2	B2-U0-G2	B2-U0-G2
	K7						B2-U0-G2	B2-U0-G2	B2-U0-G2
	L7						B2-U0-G2	B2-U0-G2	B2-U0-G2
	M7						B2-U0-G2	B2-U0-G2	B2-U0-G2
	N7						B2-U0-G2	B2-U0-G2	B2-U0-G2
12	A7	12000	11500	10600	91	136	B3-U0-G3	B3-U0-G3	B3-U0-G3
	B7						B2-U0-G2	B2-U0-G2	B2-U0-G2
	C7						B2-U0-G2	B2-U0-G2	B2-U0-G2
	D7						B2-U0-G2	B2-U0-G2	B2-U0-G2
	E7						B3-U0-G3	B3-U0-G3	B3-U0-G3
	J7	11160	10695	9858		126	B3-U0-G2	B2-U0-G2	B2-U0-G2
	K7						B2-U0-G2	B2-U0-G2	B2-U0-G2
	L7						B2-U0-G2	B2-U0-G2	B2-U0-G2
	M7						B2-U0-G2	B2-U0-G2	B2-U0-G2
	N7						B3-U0-G3	B3-U0-G3	B2-U0-G2
13	A7	13000	12400	11400	101	131	B3-U0-G3	B3-U0-G3	B3-U0-G3
	B7						B2-U0-G2	B2-U0-G2	B2-U0-G2
	C7						B2-U0-G3	B2-U0-G2	B2-U0-G2
	D7						B2-U0-G2	B2-U0-G2	B2-U0-G2
	E7						B3-U0-G3	B3-U0-G3	B3-U0-G3
	J7	12090	11532	10602		122	B3-U0-G2	B3-U0-G2	B2-U0-G2
	K7						B2-U0-G2	B2-U0-G2	B2-U0-G2
	L7						B2-U0-G3	B2-U0-G2	B2-U0-G2
	M7						B2-U0-G2	B2-U0-G2	B2-U0-G2
	N7						B3-U0-G3	B3-U0-G3	B3-U0-G3
14	A7	14000	13400	12300	112	127	B3-U0-G3	B3-U0-G3	B3-U0-G3
	B7						B2-U0-G2	B2-U0-G2	B2-U0-G2
	C7						B2-U0-G3	B2-U0-G3	B2-U0-G3
	D7						B2-U0-G2	B2-U0-G2	B2-U0-G2
	E7						B3-U0-G3	B3-U0-G3	B3-U0-G3
	J7	13020	12462	11439		119	B3-U0-G3	B3-U0-G2	B3-U0-G2
	K7						B2-U0-G2	B2-U0-G2	B2-U0-G2
	L7						B2-U0-G3	B2-U0-G3	B2-U0-G2
	M7						B2-U0-G3	B2-U0-G2	B2-U0-G2
	N7						B3-U0-G3	B3-U0-G3	B3-U0-G3

* LPW based on 120-277 V, 0-10 V dimming, 4000K CCT, & 70 CRI (utilizing non-rounded lumens & watts)

CUSTOMER NAME _____

PROJECT NAME _____

DATE _____ TYPE _____

CATALOG NUMBER _____

LUMEN CODE	DISTRIBUTION	TYPICAL INITIAL LUMENS (CRI 70)			TYPICAL WATTAGE		LPW*	BUG RATINGS (CRI 70)		
		4000K	3000K	2700K	120-277V	347-480V		4000K	3000K	2700K
15	A7	15000	14400	13900	116		134	B3-U0-G3	B3-U0-G3	B3-U0-G3
	B7							B2-U0-G3	B2-U0-G2	B2-U0-G2
	C7							B2-U0-G3	B2-U0-G3	B2-U0-G3
	D7							B2-U0-G2	B2-U0-G2	B2-U0-G2
	E7							B3-U0-G3	B3-U0-G3	B3-U0-G3
	J7	13950	13392	12927			125	B3-U0-G3	B3-U0-G3	B3-U0-G3
	K7							B3-U0-G3	B2-U0-G2	B2-U0-G2
	L7							B2-U0-G3	B2-U0-G3	B2-U0-G3
	M7							B2-U0-G3	B2-U0-G3	B2-U0-G3
	N7							B3-U0-G3	B3-U0-G3	B3-U0-G3
16	A7	15700	15000	14600	123		129	B3-U0-G3	B3-U0-G3	B3-U0-G3
	B7							B3-U0-G3	B2-U0-G3	B2-U0-G3
	C7							B2-U0-G3	B2-U0-G3	B2-U0-G3
	D7							B2-U0-G2	B2-U0-G2	B2-U0-G2
	E7							B3-U0-G3	B3-U0-G3	B3-U0-G3
	J7	14601	13950	13578			120	B3-U0-G3	B3-U0-G3	B3-U0-G3
	K7							B3-U0-G3	B3-U0-G3	B3-U0-G2
	L7							B3-U0-G3	B2-U0-G3	B2-U0-G3
	M7							B2-U0-G3	B2-U0-G3	B2-U0-G3
	N7							B3-U0-G3	B3-U0-G3	B3-U0-G3

* LPW based on 120-277 V, 0-10 V dimming, 4000K CCT, & 70 CRI (utilizing non-rounded lumens & watts)

LUMEN MULTIPLIER			
CCT	LUMEN LEVEL	70 CRI	80 CRI
2700K	03-07	See Claims Table	0.87
	08-14		0.94
	15-16		0.89
3000K	03-07		0.87
	08-14		0.91
	15-16		0.91
4000K	03-07		0.92
	08-14		0.93
	15-16		0.89

ERL1
Type II Narrow

15700 Lumens
4000K
ERL1_16A740_...IES

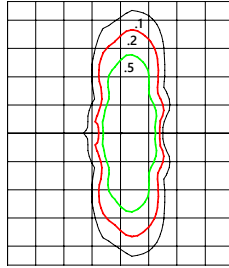

- Mounting Height at 30'
- Initial Footcandle at Grade

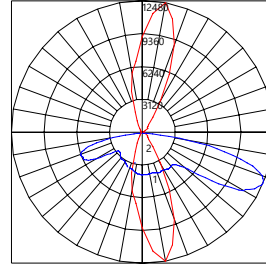

- Vertical plane at max Cd horiz. angle 80°
- Horizontal cone at max Cd vert. angle 67°

ERL1
Type II

15700 Lumens
4000K
ERL1_16B740_...IES

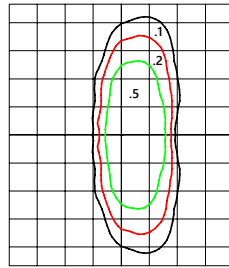

- Mounting Height at 30'
- Initial Footcandle at Grade

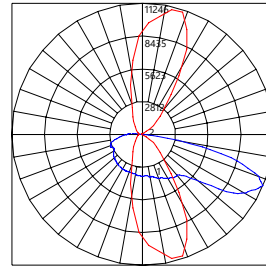

- Vertical plane at max Cd horiz angle 70°
- Horizontal cone at max Cd vert. angle 68°

ERL1
Type III

15700 Lumens
4000K
ERL1_16C740_...IES

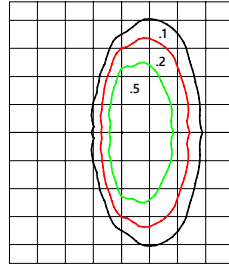

- Mounting Height at 30'
- Initial Footcandle at Grade

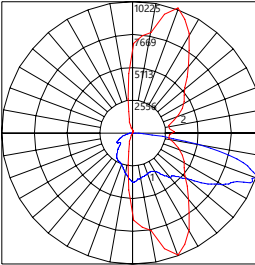

- Vertical plane at max Cd horiz angle 70°
- Horizontal cone at max Cd vert. angle 68°

ERL1
Type IV Short

15700 Lumens
4000K
ERL1_16D740_...IES

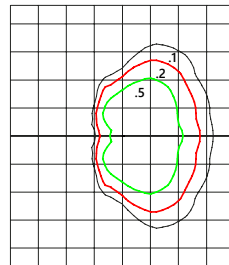

- Mounting Height at 30'
- Initial Footcandle at Grade

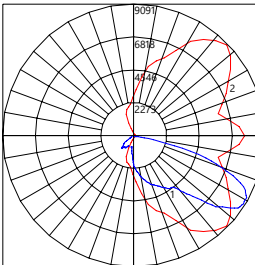

- Vertical plane at max Cd horiz angle 45°
- Horizontal cone at max Cd vert. angle 58°

ERL1
Type II
Enhanced Backlight

15700 Lumens
4000K
ERL1_16E740_...IES

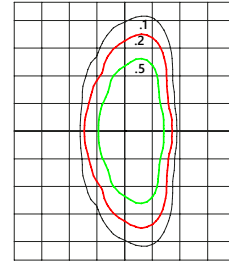

- Mounting Height at 30'
- Initial Footcandle at Grade

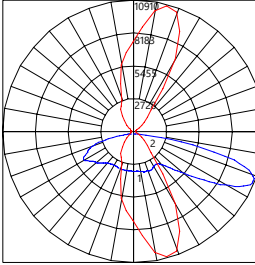

- Vertical plane at max Cd horiz angle 75°
- Horizontal cone at max Cd vert. angle 69°

ISO illuminate diagrams and polar plots are representative of the SKUs illustrated. Refer to IES files for SKU specific information.

ERL1
Type II Narrow
Visual Comfort Lens
14601 Lumens
4000K
ERL1_16J740___IES

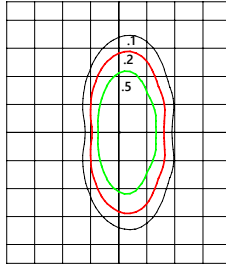

- Mounting Height at 30'
- Initial Footcandle at Grade

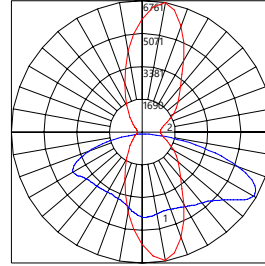

- Vertical plane at max Cd horiz. angle 80°
- Horizontal cone at max Cd vert. angle 61°

25 x 75 x 102

ERL1
Type II
Visual Comfort Lens
14601 Lumens
4000K
ERL1_16K740___IES

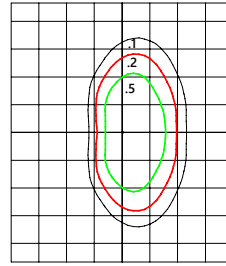

- Mounting Height at 30'
- Initial Footcandle at Grade

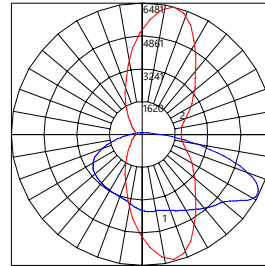

- Vertical plane at max Cd horiz angle 75°
- Horizontal cone at max Cd vert. angle 62°

ERL1
Type III
Visual Comfort Lens
14601 Lumens
4000K
ERL1_16L740___IES

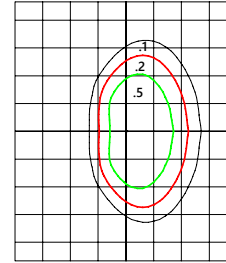

- Mounting Height at 30'
- Initial Footcandle at Grade

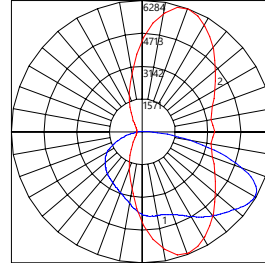

- Vertical plane at max Cd horiz angle 70°
- Horizontal cone at max Cd vert. angle 60°

ERL1
Type IV Short
Visual Comfort Lens
14601 Lumens
4000K
ERL1_16M740___IES

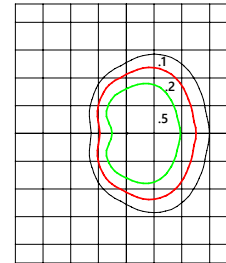

- Mounting Height at 40'
- Initial Footcandle at Grade

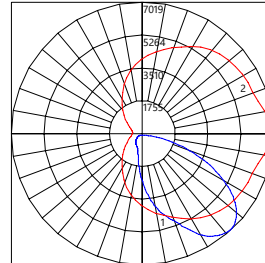

- Vertical plane at max Cd horiz angle 0°
- Horizontal cone at max Cd vert. angle 43°

ERL1
Type II-EB
Visual Comfort Lens
14601 Lumens
4000K
ERL1_16N740___IES

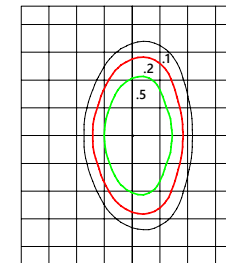

- Mounting Height at 40'
- Initial Footcandle at Grade

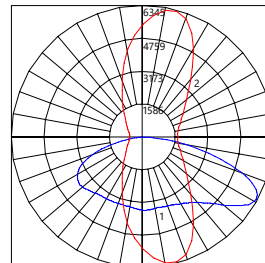

- Vertical plane at max Cd horiz angle 75°
- Horizontal cone at max Cd vert. angle 61°

ISO illuminate diagrams and polar plots are representative of the SKUs illustrated. Refer to IES files for SKU specific information.

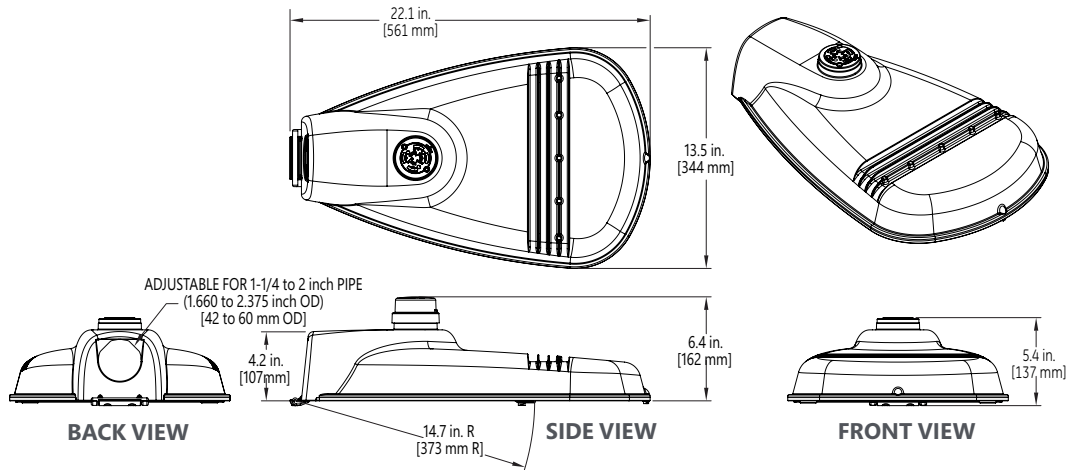

Mounting

- Adjustable for 1.25 to 2 in. nominal mounting pipe (1.660 to 2.375 inch OD)
- Integral diecast mounting pipe stop
- Slipfitter with +/- 5 degrees of leveling adjustment

Effective Projected Area

- 0.5 ft² max (0.046 m²)

Weight

- 12.4 lb (5.6 kg)

Accessories

SAP Number	Part Number	Description
93029237G	PED-MV-LED-7	ANSI C136.41 Dimming PE, 120-277V
93029238G	PED-347-LED-7	ANSI C136.41 Dimming PE, 347V
93029239G	PED-480-LED-7	ANSI C136.41 Dimming PE, 480V
28299	PECOTL	Long Life PE 120-277V
93147530	PECHTL	Long Life PE 347-480V
73251	SCCL-PECTL	Shorting Cap

Network Lighting Controls



Current's **LightGrid** Outdoor Lighting Control System is designed for Street and Roadway Applications. It enables remote monitoring, control, and asset management of a single fixture or a group of fixtures through a web enabled Central Management System.

HOUSE SIDE SHIELDS

PRODUCT CODE	CATALOG NUMBER
93024487G	ELSHS-ERL1-BLCK
93046386G	ELSHS-ERL1-GRAY
93068998	ELSHS-ERL1-DKBZ



STREET SIDE SHIELDS

PRODUCT CODE	CATALOG NUMBER
93092595	ELSFS-ERL1-BLCK-10
93108740G	ELSFS-ERL1-GRAY-10
93092906	ELSFS-ERL1-BLCK-15
93105144G	ELSFS-ERL1-GRAY-15
93088130	ELSFS-ERL1-BLCK-20
93088131G	ELSFS-ERL1-GRAY-20



SIDE SHIELDS (L&R)

L/R shield kit is comprised of right and left items
but cannot be installed in combination

PRODUCT CODE	CATALOG NUMBER
93118695G	ELS-ERL1H-LEFTRIGHTSIDEKIT-BLCK-10

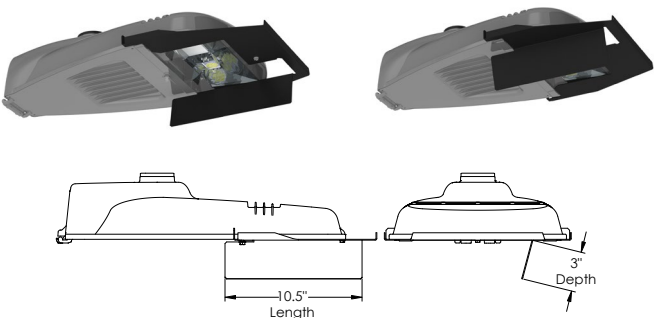

ERL1 with LEFT & RIGHT Shields

NOTES:

1. 10 = 1" Shield Depth; 15 = 1.5" Shield Depth; 20 = 2" Shield Depth
2. Black is recommended to reduce potential for glare coming off of the shield
3. Use "House Side" Shield to block light trespass behind the pole
4. Use "Street Side" / Front Shield to block light trespass across the street