

The background of the entire page is a collection of various Leviton electrical components. In the top left, there is a silver metal switch mechanism with "LEVITON" and "20A-120V 277VAC" printed on it. To its right is a white plastic switch component with a metal screw. In the top right, a stainless steel emergency switch is shown with a white rocker and the word "EMERGENCY" in red. In the center, a stainless steel switch plate with a single screw and a rectangular cutout is visible. In the bottom right, there is a white and black switch component with a metal screw and a yellow plastic cover. In the bottom left, a metal switch component with "LEVITON" and "702-402" is partially visible.

Switches

Commercial & Industrial Grade

ORDERING GUIDE

Commercial & Industrial Grade Switch Overview

PROBLEM SOLVING SOLUTIONS

Look for the **GREEN** icons shown below to assist you in browsing for the ideal switch.



PILOT LIGHT & ILLUMINATED

Featuring a light in the toggle or rocker, these switches illuminate to alert you from afar if your device is ON or OFF.



TAMPER-RESISTANT & KEY LOCKING

Switches designed to only be operated by authorized users.



ANTIMICROBIAL TREATED DEVICES

Made durable in order to withstand harsh chemical cleaning products, stringent washings, and UV lights with minimal wear and tear while inhibiting bacterial growth.



LEV-LOK MODULAR WIRING DEVICES

Features a simple twist-and-lock wiring module that allows for 3X faster installations and 5X faster swap outs than traditional wiring.



LEADED

Pre-attached leads save you time by simplifying installation and wiring.

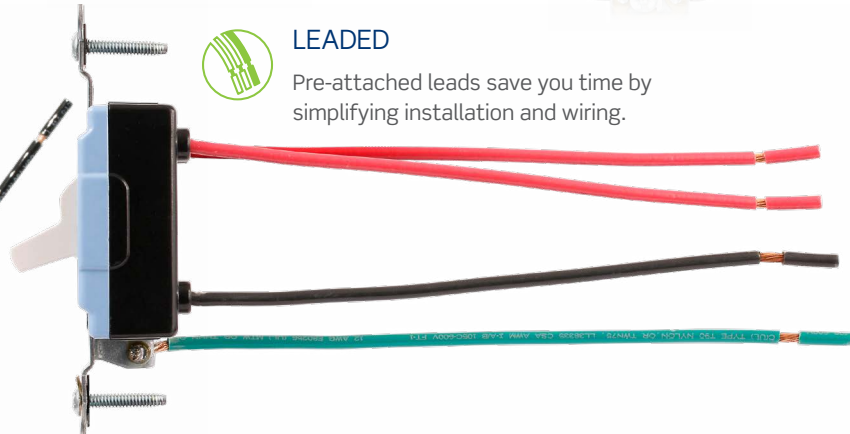

MOMENTARY

Momentary switches are actuated when pressed, like a gym door or doorbell.



MAINTAINED

Maintained switches change position when actuated, and remain in that position until actuated again, like an ON/OFF button.



CANADIAN

A "Canadian" switch is CSA Listed only, Non-Grounding, rated 347 VAC, and has a strap for a 3.531 inch box mount.



FED SPEC



Leviton uses several Nationally Recognized Testing Labs (NRTLs) for certification of switches. UL and CSA are two of these NRTLs. When you see the UL, CSA, or cULus symbols, you can have the confidence that the devices adhere to strict scientific safety, quality or security standards.

In addition to complying with UL general use requirements, when you see the Fed Spec marking you are assured that the switch has been investigated for compliance with US Federal Specification W-S-896 for the purpose of more durability and service life.

Commercial & Industrial Grade Switches

SELECTION GUIDE



TABLE OF CONTENTS

Overview	2
Switches	4
Toggle Switches	5
Decora Plus™ Switches	11
Lev-lok® Switches	13
Antimicrobial Treated Switches	16
Specialty Switches	18
Tamper-Resistant	19
Key Locking	19
Momentary	19
Maintained	20
Hospital Call	20
Low Voltage	21
Select Wallplates	22
Wiring Diagrams	23



COMMON CATEGORIES

COMMERCIAL SPECIFICATION GRADE

The perfect balance between performance and value. Commercial grade switches feature a galvanized steel strap, are available in Decora style, and go up to 20 Amp.

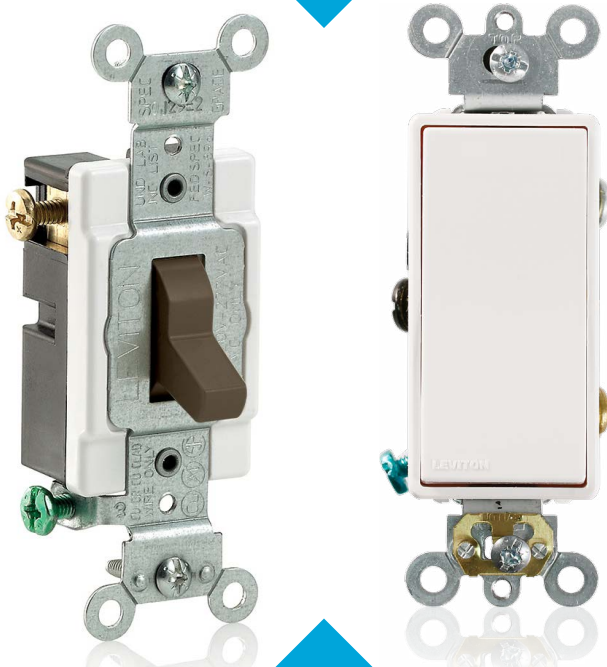

INDUSTRIAL SPECIFICATION GRADE

The ideal solution for demanding applications requiring robust construction and exceptional electrical performance. Industrial grade switches feature a heavy-duty thicker gauge galvanized steel strap for longer service life, and go up to 30 Amp.



KEY TERMINOLOGY

Wiring diagrams for the below switch types appear on page 23.

SINGLE POLE

Controls light(s)/load(s) from one location

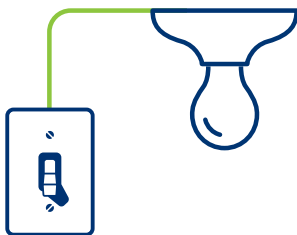

DOUBLE POLE

Controls small motor loads

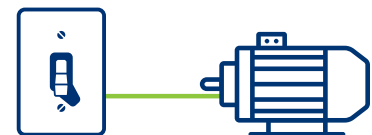

3-WAY

Controls light(s)/load(s) from two locations



4-WAY

Controls light(s) from three locations
One 4-way switch and two 3-way switches must be used in a 4-way application

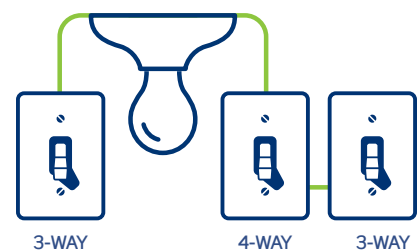

COMMERCIAL SPECIFICATION GRADE				
120/277 V AC				
Features		Color	15 Amp	20 Amp
Single Pole • Side Wire • Fed Spec Rated	FED SPEC	White	CS115-2W	CS120-2W
		Ivory	CS115-2I	CS120-2I
		Lt Almond	CS115-2T	CS120-2T
		Brown	CS115-2	CS120-2
		Gray	CS115-2GY	CS120-2GY
		Black	CS115-2E	CS120-2E
		White	CS215-2W	CS220-2W
		Ivory	CS215-2I	CS220-2I
		Lt Almond	—	CS220-2T
		Brown	CS215-2	CS220-2
Double Pole • Side Wire • Fed Spec Rated	FED SPEC	White	CS315-2W	CS320-2W
		Ivory	CS315-2I	CS320-2I
		Lt Almond	CS315-2T	CS320-2T
		Brown	CS315-2	CS320-2
		Gray	CS315-2GY	CS320-2GY
3-Way • Side Wire • Fed Spec Rated	FED SPEC	White	CS415-2W	CS420-2W
		Ivory	CS415-2I	CS420-2I
		Lt Almond	CS415-2T	CS420-2T
		Brown	CS415-2	CS420-2
		Gray	CS415-2GY	CS420-2GY
4-Way • Side Wire • Fed Spec Rated	FED SPEC	White	CSB1-15W	CSB1-20W
		Ivory	CSB1-15I	CSB1-20I
		Lt Almond	CSB1-15T	CSB1-20T
		Brown	CSB1-15	CSB1-20
		Gray	CSB1-15G	CSB1-20G
Single Pole • Back and Side Wire • Fed Spec Rated	FED SPEC	White	CSB2-15W	CSB2-20W
		Ivory	CSB2-15I	CSB2-20I
		Lt Almond	CSB2-15T	CSB2-20T
		Brown	CSB2-15	CSB2-20
		Gray	—	CSB2-20G
Double Pole • Back and Side Wire • Fed Spec Rated	FED SPEC	White	CSB3-15W	CSB3-20W
		Ivory	CSB3-15I	CSB3-20I
		Lt Almond	CSB3-15T	CSB3-20T
		Brown	CSB3-15	CSB3-20
		Gray	—	CSB3-20G
3-Way • Back and Side Wire • Fed Spec Rated	FED SPEC	White	CSB4-15W	CSB4-20W
		Ivory	CSB4-15I	CSB4-20I
		Lt Almond	CSB4-15T	CSB4-20T
		Brown	CSB4-15	CSB4-20
		Gray	—	CSB4-20G
4-Way • Back and Side Wire • Fed Spec Rated	FED SPEC	White	CSB4-15W	CSB4-20W
		Ivory	CSB4-15I	CSB4-20I
		Lt Almond	CSB4-15T	CSB4-20T
		Brown	CSB4-15	CSB4-20
		Gray	—	CSB4-20G

STANDARD TOGGLE



CS120-2GY



CS320-2I



CSB4-20W

Toggle Switches





COMMERCIAL SPECIFICATION GRADE

120/277 V AC





Features		Color	15 Amp	20 Amp	
FRAMED TOGGLE	Single Pole • Framed Toggle • Side Wire • Fed Spec Rated	FED SPEC	White	54501-2W	54521-2W
			Ivory	54501-2I	54521-2I
			Brown	54501-2	54521-2
			Gray	54501-2GY	54521-2GY
	Double Pole • Framed Toggle • Side Wire • Fed Spec Rated	FED SPEC	White	54502-2W	54522-2W
			Ivory	54502-2I	54522-2I
			Brown	54502-2	54522-2
	3-Way • Framed Toggle • Side Wire • Fed Spec Rated	FED SPEC	White	54503-2W	54523-2W
			Ivory	54503-2I	54523-2I
			Brown	54503-2	54523-2
			Gray	54503-2GY	54523-2GY
	4-Way • Framed Toggle • Side Wire • Fed Spec Rated	FED SPEC	White	54504-2W	54524-2W
			Ivory	54504-2I	54524-2I
			Lt Almond	54504-2T	—
			Brown	54504-2	54524-2
			Gray	54504-2GY	54524-2GY
	Single Pole • Framed Toggle • Side Wire • Non-Grounding • Fed Spec Rated	FED SPEC	White	1101-CW	—
			Ivory	1101-CI	—
Brown			1101-CB	—	
Gray			1101-CG	—	
Black			1101-CE	—	
—			—	—	
Double Pole • Framed Toggle • Side Wire • Non-Grounding • Fed Spec Rated	FED SPEC	White	1102-CW	—	
		Ivory	1102-CI	—	
		Brown	1102-CB	—	
3-Way • Framed Toggle • Side Wire • Non-Grounding • Fed Spec Rated	FED SPEC	White	1103-CW	—	
		Ivory	1103-CI	—	
		Brown	1103-CB	—	
4-Way • Framed Toggle • Side Wire • Non-Grounding • Fed Spec Rated	FED SPEC	White	1104-CW	—	
		Ivory	1104-CI	—	
		Brown	1104-CB	—	
		Black	1104-CE	—	

120 V AC

Features		Color	15 Amp	20 Amp	
ILLUMINATED	Single Pole • Lighted Handle Locator - Toggle Illuminated when OFF • Side Wire • Does Not Require a Neutral Wire • Fed Spec Rated	 FED SPEC	White	5501-LHW	—
			Ivory	5501-LHI	—
ILLUMINATED	3-Way • Lighted Handle Locator - Toggle Illuminated when OFF • Side Wire • Does Not Require a Neutral Wire • Fed Spec Rated	 FED SPEC	White	5503-LHW	—
			Ivory	5503-LHI	—



COMMERCIAL SPECIFICATION GRADE						
347 V AC						
Features		Color	15 Amp	20 Amp	30 Amp	
FRAMED TOGGLE	Single Pole • Framed Toggle • Side Wire • Non-Grounding • Canadian		White	18201-CW	—	—
			Ivory	18201-CI	—	—
			Brown	18201-CB	—	—
			Gray	18201-CG	—	—
	Double Pole • Framed Toggle • Side Wire • Non-Grounding • Canadian		White	18202-CW	—	—
			Ivory	18202-CI	—	—
	3-Way • Framed Toggle • Side Wire • Non-Grounding • Canadian		White	18203-CW	—	—
			Ivory	18203-CI	—	—
			Brown	18203-CB	—	—
			Gray	18203-CG	—	—
	4-Way • Framed Toggle • Side Wire • Non-Grounding • Canadian		White	18204-CW	—	—
			Ivory	18204-CI	—	—
			Gray	18204-CG	—	—

INDUSTRIAL SPECIFICATION GRADE								
120/277 V AC								
Features		Color	15 Amp	20 Amp	30 Amp			
STANDARD TOGGLE	Single Pole • Back and Side Wire • Self-Grounding • Fed Spec Rated		White	1201-2W	1221-2W	3031-2W		
			Ivory	1201-2I	1221-2I	3031-2I		
			Lt Almond	—	1221-2T	—		
			Brown	1201-2	1221-2	3031-2		
			Gray	1201-2GY	1221-2GY	—		
			Black	—	1221-2E	—		
			Red	1201-2R	1221-2R	—		
			Double Pole • Back and Side Wire • Self-Grounding • Fed Spec Rated		White	1202-2W	1222-2W	3032-2W
					Ivory	1202-2I	1222-2I	3032-2I
					Lt Almond	—	1222-2T	—
	Brown	1202-2			1222-2	3032-2		
	Gray	1202-2GY			1222-2GY	—		
	Black	—			1222-2E	3032-2E		
	Red	—			1222-2R	3032-2R		
	3-Way • Back and Side Wire • Self-Grounding • Fed Spec Rated				White	1203-2W	1223-2W	3033-2W
			Ivory	1203-2I	1223-2I	3033-2I		
			Lt Almond	1203-2T	1223-2T	—		
			Brown	1203-2	1223-2	3033-2		
			Gray	1203-2GY	1223-2GY	—		
			Black	1203-2E	1223-2E	—		
			Red	1203-2R	1223-2R	—		
			4-Way • Back and Side Wire • Self-Grounding • Fed Spec Rated		White	1204-2W	1224-2W	—
					Ivory	1204-2I	1224-2I	—
					Lt Almond	—	1224-2T	—
	Brown	1204-2			1224-2	—		
	Gray	1204-2GY			1224-2GY	—		
	Black	—			1224-2E	—		
	Red	—			1224-2R	—		



INDUSTRIAL SPECIFICATION GRADE

120/277 V AC

Features		Color	15 Amp	20 Amp	30 Amp	
STANDARD TOGGLE	Single Pole • Back and Side Wire • Fed Spec Rated		White	—	1221-SW	—
			Ivory	—	1221-SI	—
			Lt Almond	—	1221-ST	—
			Brown	—	1221-S	—
			Gray	—	1221-SGY	—
			Red	—	1221-SR	—
	Double Pole • Back and Side Wire • Fed Spec Rated		White	—	1222-SW	—
			Ivory	—	1222-SI	—
			Brown	—	1222-S	—
	3-Way • Back and Side Wire • Fed Spec Rated		White	—	1223-SW	—
			Ivory	—	1223-SI	—
			Lt Almond	—	1223-ST	—
			Brown	—	1223-S	—
			Gray	—	1223-SGY	—
			Red	—	1223-SR	—
	4-Way • Back and Side Wire • Fed Spec Rated		White	—	1224-SW	—
			Ivory	—	1224-SI	—
			Brown	—	1224-S	—
Single Pole • Three 6", #12AWG THHN Leads (2 Black & 1 Green Ground) • Self-Grounding • Fed Spec Rated		White	1241-W	1243-W	—	
		Ivory	1241-I	1243-I	—	
		Lt Almond	—	1243-A	—	
		Gray	1241-LGY	1243-LGY	—	
		White	1242-W	1244-W	—	
3-Way • Four 6", #12AWG THHN Leads (1 Black, 2 Red & 1 Green Ground) • Self-Grounding • Fed Spec Rated		Ivory	1242-I	1244-I	—	
		Lt Almond	—	1244-A	—	
		Gray	—	1244-LGY	—	

120 V AC

Features		Color	15 Amp	20 Amp	30 Amp	
ILLUMINATED	Single Pole • Lighted Handle Locator - Toggle Illuminated when OFF • Back and Side Wire • Self-Grounding • Does Not Require a Neutral Wire • Fed Spec Rated		White	1201-LHW	1221-LHW	—
			Ivory	1201-LHI	1221-LHI	3031-LHI
			Red	—	1221-LHR	—
	3-Way • Lighted Handle Locator - Toggle Illuminated when OFF • Back and Side Wire • Self-Grounding • Does Not Require a Neutral Wire • Fed Spec Rated		Clear	1201-LHC	1221-LHC	—
			White	1203-LHW	1223-LHW	—
			Ivory	1203-LHI	1223-LHI	—
			Red	—	1223-LHR	—
			Clear	1203-LHC	1223-LHC	—

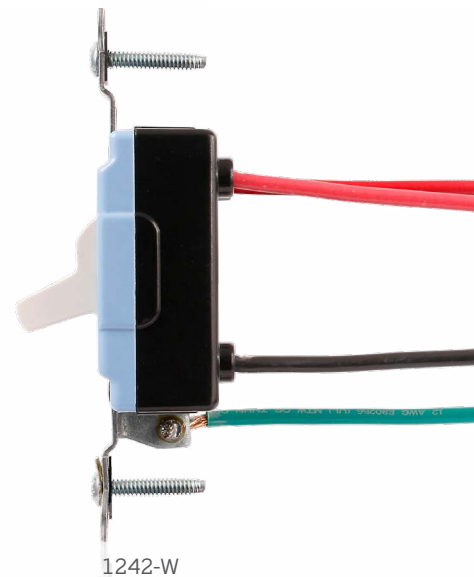

INDUSTRIAL SPECIFICATION GRADE

120 V AC

Features		Color	15 Amp	20 Amp	30 Amp
PILOT LIGHT	Single Pole	Red	1201-PLR	1221-PLR	3031-PLR
	• Pilot Light - Toggle Illuminated when ON	Clear	1201-PLC	1221-PLC	—
	• Back and Side Wire				
	• Self-Grounding				
	• Requires a Neutral Wire				
	• Fed Spec Rated				
	Double Pole	Red	1202-PLR	1222-PLR	3032-PLR
	• Pilot Light - Toggle Illuminated when ON	Clear	—	1222-PLC	3032-PLC
	• Back and Side Wire				
• Self-Grounding					
• Fed Spec Rated					
3-Way	Red	1203-PLR	1223-PLR	—	
• Pilot Light - Toggle Illuminated when ON	Clear	1203-PLC	1223-PLC	—	
• Back and Side Wire					
• Two 6", #18AWG AWM TEW Leads (1 Black & 1 White)					
• Self-Grounding					
• Requires a Neutral Wire					
• Fed Spec Rated					



277 V AC

Features		Color	15 Amp	20 Amp	30 Amp
ILLUMINATED	Single-Pole	White	—	1221-7LW	—
	• Lighted Handle Locator - Toggle Illuminated when OFF	Ivory	—	1221-7LI	—
	• Back and Side Wire	Clear	—	1221-7LC	—
	• Self-Grounding				
	• Fed Spec Rated				
	3-Way	White	—	1223-7LW	—
	• Lighted Handle Locator - Toggle Illuminated when OFF	Ivory	—	1223-7LI	—
	• Back and Side Wire	Clear	—	1223-7LC	—
	• Self-Grounding				
• Fed Spec Rated					
PILOT LIGHT	Single Pole	Red	—	1221-7PR	—
	• Pilot Light - Toggle Illuminated when ON	Clear	—	1221-7PC	—
	• Back and Side Wire				
	• Self-Grounding				
	• Requires a Neutral Wire				
	• Fed Spec Rated				
Double Pole	Red	—	1222-7PR	—	
• Pilot Light - Toggle Illuminated when ON					
• Back and Side Wire					
• Self-Grounding					
• Fed Spec Rated					



INDUSTRIAL SPECIFICATION GRADE

277 V AC

Features		Color	15 Amp	20 Amp	30 Amp
PILOT LIGHT	3-Way	Red	—	1223-7PR	—
	<ul style="list-style-type: none"> Pilot Light - Toggle Illuminated when ON Back and Side Wire Two 6", #18AWG AWM TEW Leads (1 Black & 1 White) Self-Grounding Requires a Neutral Wire Fed Spec Rated 	 			

347 V AC

Features		Color	15 Amp	20 Amp	30 Amp	
STANDARD TOGGLE	Single Pole	White	18201-W	18221-W	—	
	<ul style="list-style-type: none"> Back and Side Wire Non-Grounding Canadian 	Ivory	18201-I	18221-I	—	
		Brown	18201-B	18221-B	—	
		Gray	18201-G	18221-G	—	
		Red	18201-R	18221-R	—	
		Ivory	—	18222-I	—	
	Double Pole	Brown	—	18222-B	—	
	3-Way	<ul style="list-style-type: none"> Back and Side Wire Non-Grounding Canadian 	White	18203-W	18223-W	—
			Ivory	18203-I	18223-I	—
			Brown	18203-B	18223-B	—
			Gray	18203-G	18223-G	—
			Red	18203-R	18223-R	—
			White	—	18224-W	—
4-Way			<ul style="list-style-type: none"> Back and Side Wire Non-Grounding Canadian 	Ivory	18204-I	18224-I
Brown	18204-B	18224-B		—		
Gray	18204-G	—		—		
Red	18204-R	—		—		



COMMERCIAL SPECIFICATION GRADE
120/277 V AC

Features		Color	15 Amp	20 Amp	
DECORA PLUS™	Single Pole	White	5691-2W	5621-2W	
	<ul style="list-style-type: none"> • Back and Side Wire • Self-Grounding 	Ivory	5691-2I	5621-2I	
		Lt Almond	5691-2T	5621-2T	
		Brown	5691-2	5621-2	
		Gray	5691-2GY	5621-2GY	
		Black	5691-2E	5621-2E	
		Red	—	5621-2R	
		Double Pole	White	—	5622-2W
	<ul style="list-style-type: none"> • Back and Side Wire • Self-Grounding 	Ivory	—	5622-2I	
		Lt Almond	—	5622-2T	
		Gray	—	5622-2GY	
		Black	—	5622-2E	
		Red	—	5622-2R	
		3-Way	White	5693-2W	5623-2W
		<ul style="list-style-type: none"> • Back and Side Wire • Self-Grounding 	Ivory	5693-2I	5623-2I
	Lt Almond		5693-2T	5623-2T	
	Brown		5693-2	5623-2	
	Gray		5693-2GY	5623-2GY	
	Black		5693-2E	5623-2E	
	Red		—	5623-2R	
4-Way	White		—	5624-2W	
<ul style="list-style-type: none"> • Back and Side Wire • Self-Grounding 	Ivory	—	5624-2I		
	Lt Almond	—	5624-2T		
	Brown	—	5624-2		
	Gray	—	5624-2GY		
	Black	—	5624-2E		
	Red	—	5624-2R		



120 V AC

Features		Color	15 Amp	20 Amp
PILOT LIGHT	Single Pole	White	—	5628-2W
	<ul style="list-style-type: none"> • Pilot Light - Rocker Illuminated when ON • Back and Side Wire • Requires a Neutral Wire • Self-Grounding 	Ivory	—	5628-2I
		Lt Almond	—	5628-2T
		3-Way	White	—
	<ul style="list-style-type: none"> • Pilot Light - Rocker Illuminated when ON • Back and Side Wire • Two 6", #18AWG AWM TEW Leads (1 Black & 1 White) • Requires a Neutral Wire • Self-Grounding 	Ivory	—	5638-2I

COMMERCIAL SPECIFICATION GRADE							
120 V AC							
Features		Color	15 Amp	20 Amp			
ILLUMINATED	Single-Pole		White	—	5631-2W		
	<ul style="list-style-type: none"> Lighted Rocker Locator - Rocker Illuminated when OFF Back and Side Wire Self-Grounding 		Ivory	—	5631-2I		
			Lt Almond	—	5631-2T		
			Gray	—	5631-2GY		
			Black	—	5631-2E		
ILLUMINATED	Double Pole		White	—	5633-2W		
	<ul style="list-style-type: none"> Lighted Rocker Locator - Rocker Illuminated when OFF Back and Side Wire Self-Grounding 		Ivory	—	5633-2I		
			Lt Almond	—	5633-2T		
			Black	—	5633-2E		
277 V AC							
PILOT LIGHT	Single Pole		White	—	5629-2W		
	<ul style="list-style-type: none"> Pilot Light - Rocker Illuminated when ON Back and Side Wire Requires a Neutral Wire Self-Grounding 						
PILOT LIGHT	3-Way		White	—	5639-2W		
	<ul style="list-style-type: none"> Pilot Light - Rocker Illuminated when ON Back and Side Wire Two 6", #18AWG AWM TEW Leads (1 Black & 1 White) Requires a Neutral Wire Self-Grounding 						
ILLUMINATED	Single Pole		White	—	5649-2W		
	<ul style="list-style-type: none"> Lighted Rocker Locator - Rocker Illuminated when OFF Back and Side Wire Self-Grounding 						
	3-Way			White	—	5659-2W	
	<ul style="list-style-type: none"> Lighted Rocker Locator - Rocker Illuminated when OFF Back and Side Wire Self-Grounding 						
347 V AC							
Features		Color	15 Amp	20 Amp			
DECORA PLUS™	Single Pole		White	5691-CW	5621-CW		
	<ul style="list-style-type: none"> Back and Side Wire Non-Grounding Canadian 		Ivory	5691-CI	5621-CI		
			Gray	5691-CG	—		
			Black	5691-CE	—		
			Red	5691-CR	—		
	DECORA PLUS™	3-Way		White	5693-CW	5623-CW	
		<ul style="list-style-type: none"> Back and Side Wire Non-Grounding Canadian 		Ivory	5693-CI	—	
				Gray	5693-CG	—	
				Black	5693-CE	—	
DECORA PLUS™	4-Way		White	5694-CW	5624-CW		
	<ul style="list-style-type: none"> Back and Side Wire Non-Grounding Canadian 						





lev-lok® switches

The perfect productivity solution for electrical construction and maintenance applications, the Lev-lok Modular Wiring Device System includes switches, receptacles, USBs, GFCIs and occupancy sensors. Simply connect the leaded wiring module to the back of the device for quick and easy assembly!

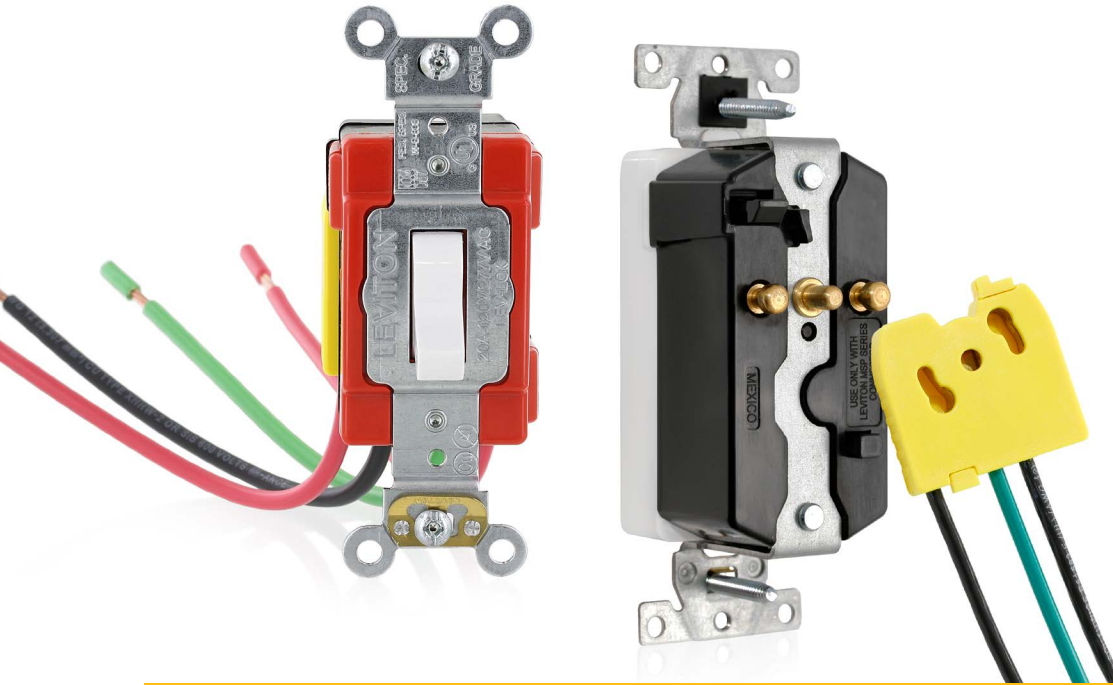

KEY FEATURES AND BENEFITS

Future Proof

It's 5x faster to replace devices in a facility to meet future needs, whether you're updating technology or meeting new requirements.



Compress Timelines

Accelerate installation and swap outs to complete projects faster than using traditional wiring.



Accurate & Secure Connection

Lev-lok lowers the risk of incorrect installation while providing a safe and secure connection.

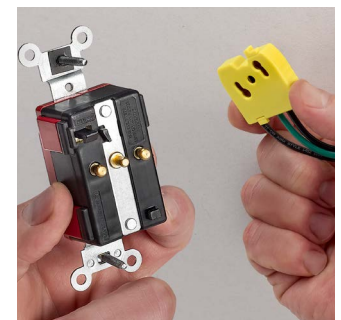

INDUSTRIAL SPECIFICATION GRADE		120/277 V AC			
Features		Color	15 Amp	20 Amp	
STANDARD TOGGLE	Single Pole <ul style="list-style-type: none"> Self-Grounding Fed Spec Rated MSPSW mating module required 	 	White	M1201-W	M1221-W
			Ivory	M1201-I	M1221-I
			Lt Almond	—	M1221-T
			Brown	—	M1221
			Gray	M1201-GY	M1221-GY
			Black	—	M1221-E
	3-Way <ul style="list-style-type: none"> Self-Grounding Fed Spec Rated M3WSW mating module required 	 	White	M1203-W	M1223-W
			Ivory	M1203-I	M1223-I
			Lt Almond	—	M1223-T
			Brown	M1203	M1223
			Gray	M1203-GY	M1223-GY
			Black	—	M1223-E
Single Pole <ul style="list-style-type: none"> Antimicrobial Treated Self-Grounding Fed Spec Rated MSPSW mating module required 	  	White	—	AM120-W	
		Ivory	—	AM120-I	
		Gray	—	AM120-GY	
		Red	—	AM120-R	
3-Way <ul style="list-style-type: none"> Antimicrobial Treated Self-Grounding Fed Spec Rated M3WSW mating module required 	  	White	—	AM320-W	
		Ivory	—	AM320-I	
		Gray	—	AM320-GY	
		Red	—	AM320-R	

INDUSTRIAL SPECIFICATION GRADE

120 V AC

Features		Color	15 Amp	20 Amp
ILLUMINATED	Single Pole	White	M1201-LHW	M1221-LHW
	<ul style="list-style-type: none"> Lighted Handle Locator - Toggle Illuminated when OFF Self-Grounding Fed Spec Rated MSPSW mating module required 	Ivory	—	M1221-LHI
		Red	—	M1221-LHR
		Clear	M1201-LHC	M1221-LHC
		White	M1203-LHW	M1223-LHW
		Clear	M1203-LHC	M1223-LHC
	3-Way			
	<ul style="list-style-type: none"> Lighted Handle Locator - Toggle Illuminated when OFF Self-Grounding Fed Spec Rated M3SW mating module required 			



M1223-LHC

INDUSTRIAL SPECIFICATION GRADE

120/277 V AC

Features		Color	15 Amp	20 Amp	
TAMPER-RESISTANT (KEY)	Single Pole	White	—	M1221-WL	
	<ul style="list-style-type: none"> Tamper-Resistant (Key) Self-Grounding Fed Spec Rated MSPSW mating module required 	Ivory	M1201-IL	M1221-IL	
		Brown	M1201-L	M1221-L	
		Gray	—	M1221-GL	
		Red	—	M1221-RL	
		White	—	M1223-WL	
		Ivory	M1203-IL	M1223-IL	
		Brown	M1203-L	M1223-L	
		Gray	—	M1223-GL	
		Red	—	M1223-RL	
		3-Way			
		<ul style="list-style-type: none"> Tamper-Resistant (Key) Self-Grounding Fed Spec Rated M3SW mating module required 			



M1221-WL

INDUSTRIAL SPECIFICATION GRADE

120/277 V AC

Features		Color	15 Amp	20 Amp
DECORA PLUS™	Single Pole	White	M5691-W	M5621-W
	<ul style="list-style-type: none"> Self-Grounding MSPSW mating module required 	Ivory	M5691-I	M5621-I
		Lt Almond	M5691-T	M5621-T
		Brown	—	M5621
		Gray	M5691-GY	M5621-GY
		Red	—	M5621-R
		White	M5693-W	M5623-W
		Ivory	M5693-I	M5623-I
		Lt Almond	M5693-T	M5623-T
		Brown	—	M5623
		Gray	M5693-GY	M5623-GY
		Red	—	M5623-R
ILLUMINATED	Single Pole	White	—	M5631-W
	<ul style="list-style-type: none"> Lighted Rocker Locator - Rocker Illuminated when OFF Self-Grounding MSPSW mating module required 	Ivory	—	M5631-I
		Lt Almond	—	M5631-T
		White	—	M5633-W
		Ivory	—	M5633-I
		Lt Almond	—	M5633-T



M5631-I

MODULES

FOR SINGLE POLE SWITCHES, 20 A, 347 V AC MAX.

Description	Module Color	Wire Type	Wire Colors	Catalog #
Stranded Wire Leads	Yellow	THHN	Black, Black, Green	MSPSW-ST
Stranded Wire Leads w/Push-in Wire Connectors	Yellow	THHN	Black, Black, Green	MSPSW-WST
Solid Wire Leads	Yellow	THHN	Black, Black, Green	MSPSW-SD
Stranded Wire Leads for 277 V Lighting Applications	Yellow	THHN	Brown, Brown, Green	MSPSW-7ST
Solid Wire Leads for 277 V Lighting Applications	Yellow	THHN	Brown, Brown, Green	MSPSW-7SD

M3WSW-ST
(Module)

FOR 3-WAY SWITCHES, 20 A, 347 V AC MAX.

Stranded Wire Leads	Yellow	XHHW-2	Black, Red, Red, Green	M3WSW-ST
Stranded Wire Leads w/Push-in Wire Connectors	Yellow	XHHW-2	Black, Red, Red, Green	M3WSW-WST
Stranded Wire Leads for 277 V Lighting Applications	Yellow	XHHW-2	Brown, Yellow, Yellow, Green	M3WSW-7ST
Solid Wire Leads	Yellow	XHHW-2	Black, Red, Red, Green	M3WSW-SD

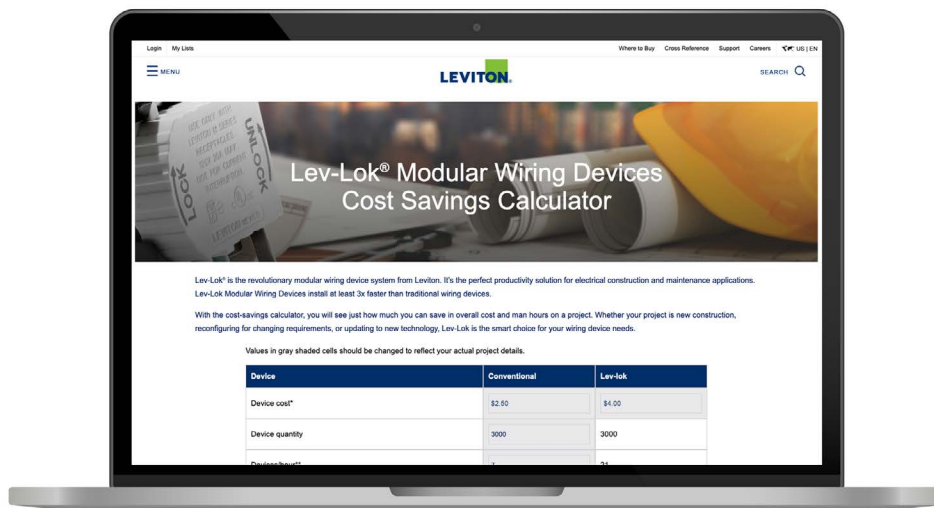

— CALCULATE YOUR SAVINGS ONLINE —
www.leviton.com/levlokcalculator



FOR MORE INFORMATION ON THE FULL LINE: www.leviton.com/levlok



Antimicrobial treated devices from Leviton contain an EPA registered silver ion additive that protects our switches and wallplates from contamination.

(WALLPLATES SOLD SEPARATELY)



A1221-2W
Standard Toggle with
84001-A40 Wallplate
(SOLD SEPARATELY)

Look for the antimicrobial marking
on treated wallplates and switches



Also available
in Lev-Lok
Modular
Wiring Versions
AM320-W Shown



A1223-GY

INDUSTRIAL SPECIFICATION GRADE

120/277 V AC

Features

			Color	15 Amp	20 Amp
STANDARD TOGGLE	Single Pole		White	—	A1221-2W
			Ivory	—	A1221-2I
			Gray	—	A1221-GY
			Red	—	A1221-2R
	3-Way		White	—	A1223-2W
			Ivory	—	A1223-2I
			Gray	—	A1223-GY
			Red	—	A1223-2R
LEV-LOK® MODULAR	Single Pole		White	—	AM120-W
			Ivory	—	AM120-I
			Gray	—	AM120-GY
			Red	—	AM120-R
	3-Way		White	—	AM320-W
			Ivory	—	AM320-I
			Gray	—	AM320-GY
			Red	—	AM320-R

WALLPLATES





Antimicrobial Treated Single Gang Toggle	84001-A40
Antimicrobial Treated Single Gang Toggle Marked "EMERGENCY"	84001-E4A
Antimicrobial Treated Wallplate Two Gang Toggle	84009-A40



84009-A40
Toggle Wallplate
(SOLD SEPARATELY)



COMMERCIAL SPECIFICATION GRADE

120/277 V AC

Features		Color	15 Amp	20 Amp	
DECORA PLUS™	Single Pole		White	—	A5621-2W
	<ul style="list-style-type: none"> • Antimicrobial Treated • Back and Side Wire • Self-Grounding 		Ivory	—	A5621-2I
			Gray	—	A5621-2GY
			Red	—	A5621-2R
	3-Way		White	—	A5623-2W
	<ul style="list-style-type: none"> • Antimicrobial Treated • Back and Side Wire • Self-Grounding 		Ivory	—	A5623-2I
			Gray	—	A5623-2GY
			Red	—	A5623-2R
SPECIALTY	Single Pole Double Throw	 	White	A5657-2W	—
	<ul style="list-style-type: none"> • Antimicrobial Treated • Momentary Contact, Center OFF • Back and Side Wire • Self-Grounding • Available on special request 		Ivory	A5657-2I	—



24 V AC/DC

Features		Color	3 Amp		
SPECIALTY	Single Pole Double Throw	 	White	56A81-2W	—
	<ul style="list-style-type: none"> • Antimicrobial Treated • Low Voltage • Momentary Contact, Center OFF • Back and Side Wire • Self-Grounding • Available on special request 		Ivory	56A81-2I	—



A5623-2W Decora Plus™ with 84401-A40 Wallplate (SOLD SEPARATELY)

WALLPLATES

Antimicrobial Treated Single Gang Decora Plus™	84401-A40
Antimicrobial Treated Single Gang Decora Plus™ Marked "EMERGENCY"	84401-E4A
Antimicrobial Treated Two Gang Decora Plus™	84409-A40

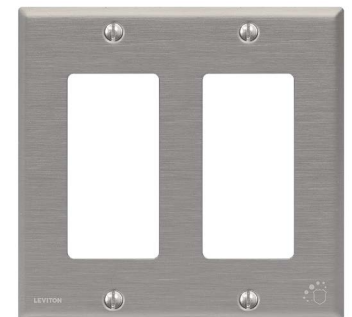

84409-A40 Decora Plus™ Wallplate (SOLD SEPARATELY)

Leviton offers a wide variety of switches that are tailor-made for simple, unique or challenging applications.

INCLUDES...

- Tamper-Resistant
- Key Locking
- Momentary
- Maintained
- Hospital Call
- Low Voltage

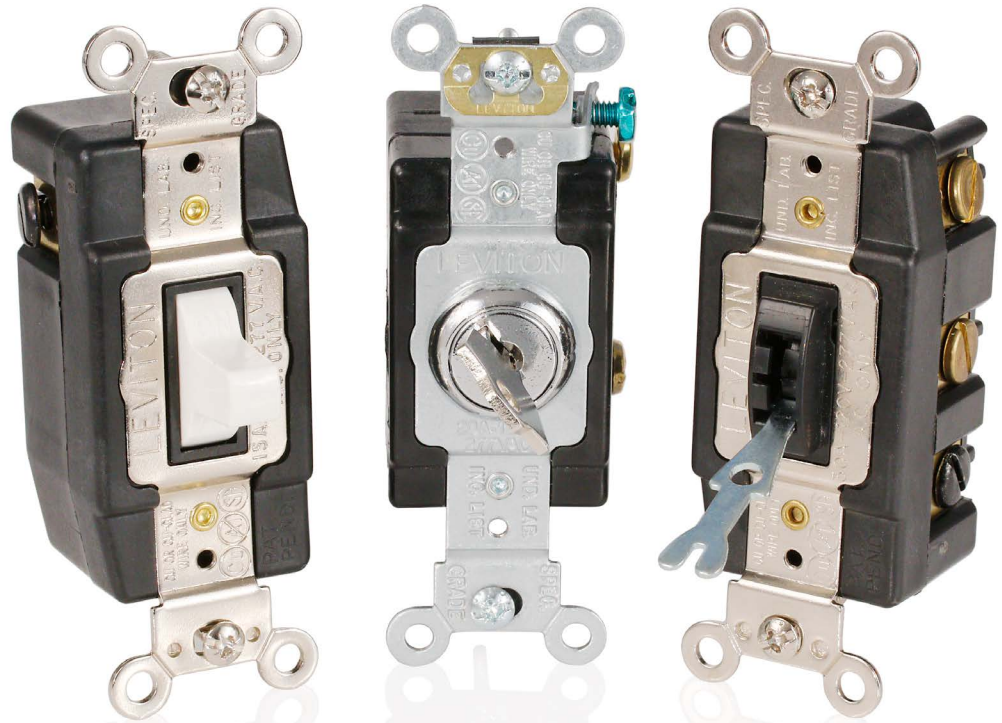

From fitness facilities to pools, conveyor systems to cooling fans, gates to lifts, Leviton has the switch to fit your need. For help choosing the appropriate solutions, contact your local Leviton sales representative.

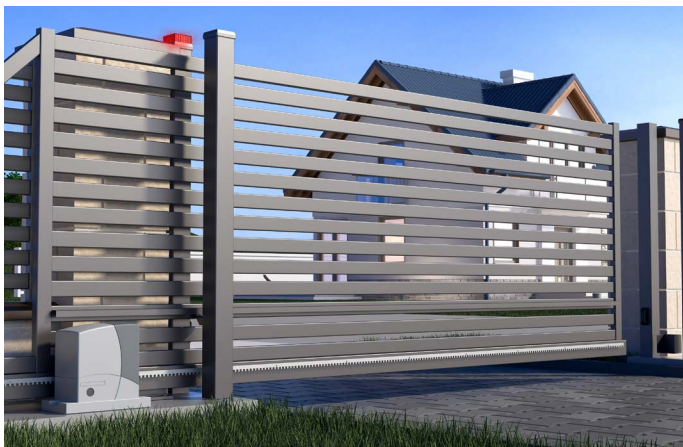

INDUSTRIAL SPECIFICATION GRADE								
120/277 V AC								
Features		Color	15 Amp	20 Amp	30 Amp			
TAMPER-RESISTANT (KEY)	Single Pole	 	White	—	1221-2WL	—		
	<ul style="list-style-type: none"> Tamper-Resistant (Key) Back and Side Wire Self-Grounding Fed Spec Rated 		Ivory	1201-2IL	1221-2IL	—		
			Brown	1201-2L	1221-2L	3031-2L		
			Gray	—	1221-2GL	—		
			Red	—	1221-2RL	—		
		Double Pole	 	Ivory	—	1222-2IL	—	
	<ul style="list-style-type: none"> Tamper-Resistant (Key) Back and Side Wire Self-Grounding Fed Spec Rated 	Brown		1202-2L	1222-2L	3032-2L		
		3-Way	 	White	—	1223-2WL	—	
	<ul style="list-style-type: none"> Tamper-Resistant (Key) Back and Side Wire Self-Grounding Fed Spec Rated 	Ivory		1203-2IL	1223-2IL	—		
		Brown		1203-2L	1223-2L	3033-2L		
		Gray		—	1223-2GL	—		
		4-Way	 	White	—	1224-2WL	—	
	<ul style="list-style-type: none"> Tamper-Resistant (Key) Back and Side Wire Self-Grounding Fed Spec Rated 	Ivory		—	1224-2IL	—		
		Brown		1204-2L	1224-2L	—		
		Gray		—	1224-2GL	—		
	KEY LOCKING	Single Pole		Chrome Lock	—	1221-2KL	—	
<ul style="list-style-type: none"> Key Locking Back and Side Wire Self-Grounding 								
Double Pole		Chrome Lock		—	1222-2KL	—		
<ul style="list-style-type: none"> Key Locking Back and Side Wire Self-Grounding 								
	3-Way		Chrome Lock	—	1223-2KL	—		
<ul style="list-style-type: none"> Key Locking Back and Side Wire Self-Grounding 								
	4-Way		Chrome Lock	—	1224-2KL	—		
<ul style="list-style-type: none"> Key Locking Back and Side Wire Self-Grounding 								
MOMENTARY CONTACT TOGGLE	Single Pole Double Throw		White	1256-W	1257-W	—		
	<ul style="list-style-type: none"> Momentary Contact, Center OFF Back and Side Wire Self-Grounding 		Ivory	1256-I	1257-I	—		
			Lt Almond	—	1257-T	—		
			Brown	1256	1257	1260		
			Gray	1256-GY	1257-GY	—		
			Red	—	1257-R	—		
		Single Pole Double Throw	 	Black	—	1257-L	—	
	<ul style="list-style-type: none"> Momentary Contact, Center OFF Tamper-Resistant (Key) Back and Side Wire Self-Grounding 							
		Double Pole Double Throw			Brown	—	—	1262
	<ul style="list-style-type: none"> Momentary Contact, Center OFF Back and Side Wire Self-Grounding 							



INDUSTRIAL SPECIFICATION GRADE

120/277 V AC

Features		Color	15 Amp	20 Amp	30 Amp
MAINTAINED CONTACT TOGGLE	Single Pole Double Throw	White	1281-W	1285-W	—
	• Maintained Contact, Center OFF	Ivory	1281-I	1285-I	1287-I
	• Back and Side Wire	Lt Almond	—	1285-T	—
	• Self-Grounding	Brown	1281	1285	1287
		Gray	—	1285-GY	—
MAINTAINED CONTACT TOGGLE	Double Pole Double Throw	White	1282-W	1286-W	1288-W
	• Maintained Contact, Center OFF	Ivory	1282-I	1286-I	1288-I
	• Back and Side Wire	Brown	1282	1286	1288
TAMPER-RESISTANT (MAINTAINED)	Single Pole Double Throw	Black	1281-L	1285-L	1287-L
	• Maintained Contact, Center OFF				
TAMPER-RESISTANT (MAINTAINED)	• Tamper-Resistant (Key)				
	• Back and Side Wire				
TAMPER-RESISTANT (MAINTAINED)	• Self-Grounding				
	Double Pole Double Throw	Black	—	—	1288-L
TAMPER-RESISTANT (MAINTAINED)	• Maintained Contact, Center OFF				
	• Tamper-Resistant (Key)				
TAMPER-RESISTANT (MAINTAINED)	• Back and Side Wire				
	• Self-Grounding				
HOSPITAL CALL TOGGLE	Single Pole	Ivory	5501-8I	—	—
	• Hospital Call	Brown	5501-8	—	—
HOSPITAL CALL TOGGLE	• Back & Side Wired				
	• Fed Spec Rated				
HOSPITAL CALL TOGGLE	Double Pole	Brown	5502-8	—	—
	• Hospital Call				
HOSPITAL CALL TOGGLE	• Back & Side Wired				
	• Fed Spec Rated				



1287-L



5501-8I

INDUSTRIAL SPECIFICATION GRADE

347 V AC

Features		Color	15 Amp	20 Amp
TAMPER-RESISTANT (KEY)	Single Pole	Brown	18201-LB	18221-LB
	• Tamper-Resistant (Key)			
	• Back and Side Wire			
	• Non-Grounding			
TAMPER-RESISTANT (KEY)	• Canadian			
	Double Pole	Brown	18202-LB	18222-LB
	• Tamper-Resistant (Key)			
	• Back and Side Wire			
TAMPER-RESISTANT (KEY)	• Non-Grounding			
	• Canadian			
	3-Way	Brown	18203-LB	18223-LB
	• Tamper-Resistant (Key)			
TAMPER-RESISTANT (KEY)	• Back and Side Wire			
	• Non-Grounding			
	• Canadian			



18222-LB

ACCESSORIES

Key for Tamper-Resistant Switch	55500-PRT
Replacement Key for Key Locking Switch	2KL

INDUSTRIAL SPECIFICATION GRADE
24 V AC/DC

Features		Color	3 Amp
LOW VOLTAGE TOGGLE	Single Pole	White	12021-2W
	<ul style="list-style-type: none"> • Back & Side Wired • Self-Grounding 	Ivory	12021-2I
	Single Pole Double Throw	White	1081-W
	<ul style="list-style-type: none"> • Back and Side Wire • Momentary Contact, Center OFF • Self-Grounding 	Ivory	1081-I
		Gray	1081-GY
		Red	1081-R

COMMERCIAL SPECIFICATION GRADE
120/277 V AC

Features		Color	15 Amp
MOMENTARY CONTACT DECORA PLUS™	Single Pole	White	5655-2W
	<ul style="list-style-type: none"> • Momentary Contact • Back & Side Wired • Self-Grounding 	Ivory	5655-2I
	Single Pole Double Throw	Lt Almond	5655-2T
	<ul style="list-style-type: none"> • Momentary Contact, Center OFF • Back & Side Wired • Self-Grounding 	Black	5655-2E
		White	5657-2W
		Ivory	5657-2I
MAINTAINED CONTACT DECORA PLUS™	Single Pole Double Throw	Lt Almond	5657-2T
	<ul style="list-style-type: none"> • Momentary Contact, Center OFF • Back & Side Wired • Self-Grounding 	Brown	5657-2
	Single Pole Double Throw	Gray	5657-2GY
	<ul style="list-style-type: none"> • Maintained Contact, Center OFF • Back & Side Wired • Self-Grounding • Rocker imprinted with "HIGH" / "OFF" / "LOW" (On special request only - Catalog No. 5685-BW) 	Black	5657-2E
	Double Pole Double Throw	White	5685-2W
	<ul style="list-style-type: none"> • Maintained Contact, Center OFF • Green Grounding Lead • Back & Side Wired • Self-Grounding 	Ivory	5685-2I
	Lt Almond	5685-2T	
	Gray	5685-2GY	
	Black	5685-2E	
	White	5686-2W	
	Ivory	5686-2I	
	Lt Almond	5686-2T	

COMMERCIAL SPECIFICATION GRADE
24 V AC/DC

Features		Color	3 Amp
LOW VOLTAGE DECORA PLUS™	Single Pole	White	56021-2W
	<ul style="list-style-type: none"> • Low Voltage • Back and Side Wire • Self-Grounding 	Ivory	56021-2I
	Single Pole Single Throw	Black	56021-2E
	<ul style="list-style-type: none"> • Low Voltage • 1 Position Momentary Contact • Back and Side Wire • Self-Grounding 	White	56080-2W
		Ivory	56080-2I
		Lt Almond	56080-2T
		Black	56080-2E
	Single Pole Double Throw	White	56081-2W
	<ul style="list-style-type: none"> • Low Voltage • 3 Position Momentary Contact, Center OFF • Back and Side Wire • Self-Grounding 	Ivory	56081-2I
	Brown	56081-2	
	Red	56081-2R	



Select Wallplates Quick Order Guide

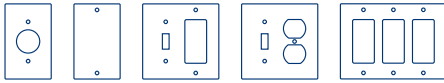

For the **FULL** offering of Leviton wallplates, visit leviton.com/wallplates

C-SERIES STAINLESS STEEL WALLPLATES

Description	Stainless Steel		
	Type 430	Type 302/304	
1-GANG	Toggle Switch	SL1	SS1-40
	Toggle Switch, Midway	SLJ1-C	SSJ1-C40
	Decora®/Decora Plus™/GFCI	SL26	SS26-40
	Decora®/Decora Plus™/GFCI, Midway	SLJ82-C	SSJ82-C40
2-GANG	2 Toggle Switch	SL2	SS2-40
	2 Toggle Switch, Midway	SLJ2-C	SSJ2-C40
	1 Toggle Switch, 1 Duplex Receptacle	SL18	SS18-40
	1 Toggle Switch, 1 Decora®/Decora Plus™/GFCI	SL126	SS126-40
	2 Decora®/Decora Plus™/GFCI	SL262	SS262-40
	2 Decora®/Decora Plus™/GFCI, Midway	SLJ62-C	SSJ62-C40



84001-LOK



84401-G40



84071-40



SL26



COVER-GS

SPECIALTY WALLPLATES

Description	Cat. No.
Gasketed Wallplate, Stainless Steel, 1-gang For use with Decora®/Decora Plus™/GFCI/Occupancy Sensors	84401-G40
Gasketed Wallplate, Stainless Steel, 1-gang, White For use with Decora®/Decora Plus™/GFCI/Occupancy Sensors	84409-G40
Gasketed Wallplate, Stainless Steel, 2-gang For use with Decora®/Decora Plus™/GFCI/Occupancy Sensors	84401-G4W
Gasketed Wallplate, Stainless Steel, 2-gang, White For use with Decora®/Decora Plus™/GFCI/Occupancy Sensors	84409-G4W
Lockout Wallplate for Toggle Switches, Type 302 Stainless Steel Includes Tamper-Resistant Screws and Spanner Wrench (Lock Not Included)	84001-LOK
Wallplate for Key Locking Switches, Type 302 Stainless Steel, 1-gang Includes Tamper-Resistant Screws and Spanner Wrench	84071-40
Wallplate for Key Locking Switches, Type 302 Stainless Steel, 2-gang Includes Tamper-Resistant Screws and Spanner Wrench	84072-40
Wallplate for Key Locking Switches, Type 302 Stainless Steel, 3-gang Includes Tamper-Resistant Screws and Spanner Wrench	84073-40
Wetguard® Watertight (IP66, NEMA 4X) Toggle Switch Cover, FS/FD mount, Yellow For use with 15-40 A Toggle Switches	COVER-S
Wetguard® Watertight (IP66, NEMA 4X) Toggle Switch Cover, FS/FD mount, Gray For use with 15-40 A Toggle Switches	COVER-GS

SINGLE POLE AND SINGLE POLE ILLUMINATED

- ① Line Hot (Brass Screw)
- ② Load (Brass Screw)
- ③ Ground (Green Screw)

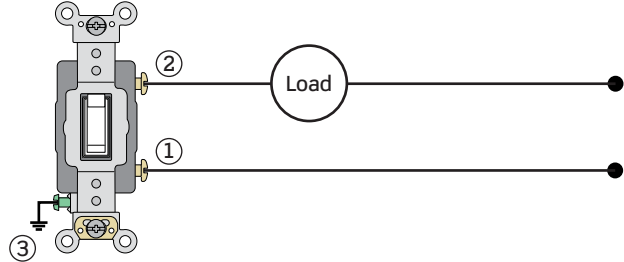

SINGLE POLE PILOT LIGHT

- ① Line Hot (Black Screw)
- ② Neutral (Silver Screw)
- ③ Load (Brass Screw)
- ④ Ground (Green Screw)

NOTE: Neutral connection required.

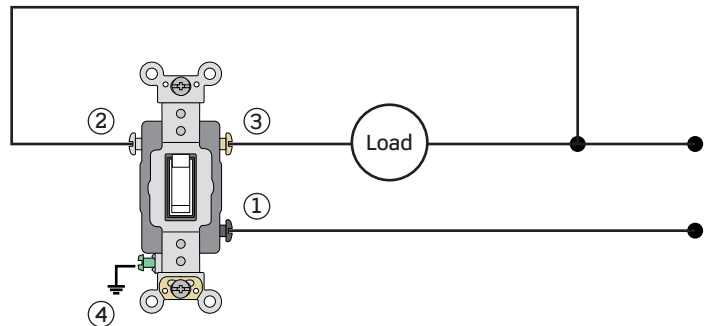

DOUBLE POLE AND DOUBLE POLE PILOT LIGHT

- ① Line Hot (Black Screw)
Circuit A
- ② Line Hot (Black Screw)
Circuit B
- ③ Load (Brass Screw)
Circuit A
- ④ Load (Brass Screw)
Circuit B
- ⑤ Ground (Green Screw)

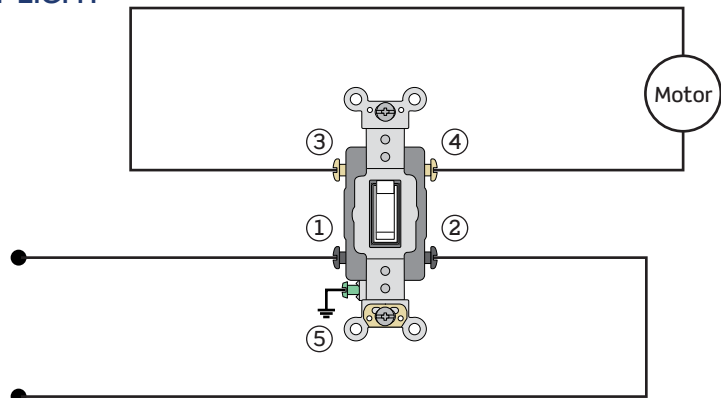

3-WAY AND 3-WAY ILLUMINATED

- ① Line Hot / Common (Black Screw)
- ② Travelers (Brass Screw to Brass Screw)
- ③ Load / Common (Black Screw)
- ④ Ground (Green Screw)

NOTE: Do not use this wiring configuration with 3-Way Pilot Light switches.

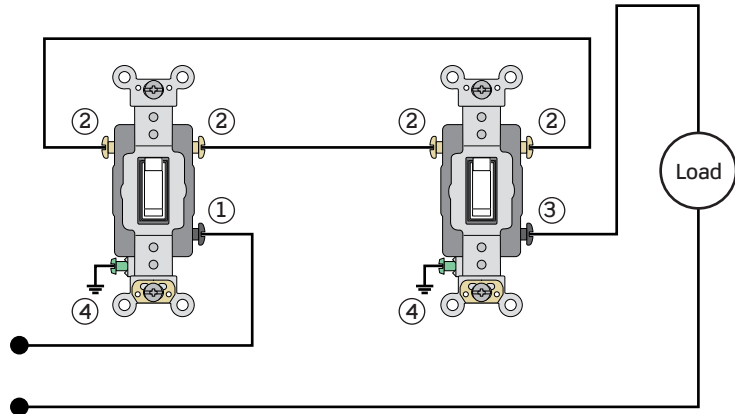

3-WAY PILOT LIGHT

- ① Line Hot / Common (Black Screw)
- ② Travelers (Brass Screw to Brass Screw)
- ③ Ground (Green Screw)
- ④ Load / Common (Black Screw)
- ⑤ Black Lead from Switch
- ⑥ White Lead from Switch
- ⑦ Neutral (White Wire)

NOTE: Neutral connection required.
Black lead must connect to load at both switch locations.
May require additional wiring to work properly.

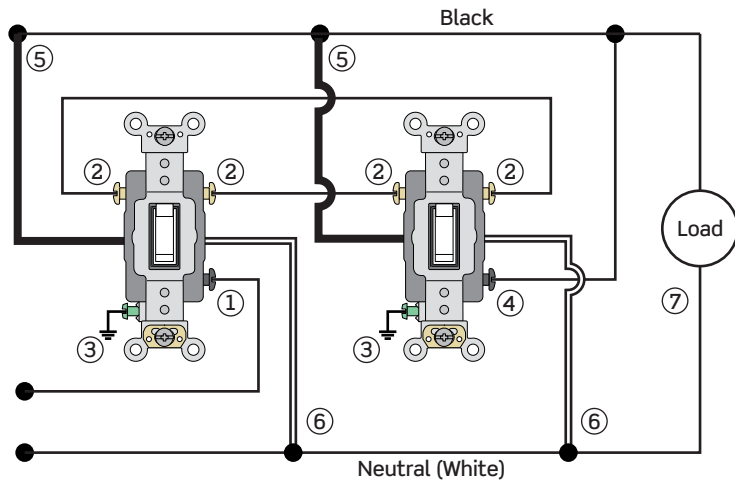

4-WAY

- ① Line Hot / Common (Black Screw)
- ② Travelers (Brass Screw from 3-Way to Brass Screw from 4-Way)
- ③ Ground (Green Screw)
- ④ Load / Common (Black Screw)

NOTE: Do not use 3-Way pilot light switches in a 4-Way application.

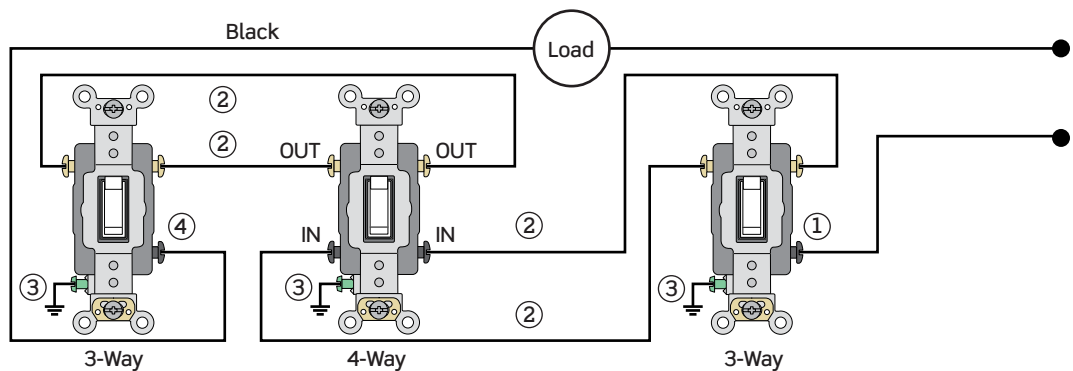

Leviton Manufacturing Co., Inc.

201 N Service Rd, Melville, NY 11747

Telephone: 1-800-323-8920 • Tech Line: 1-800-824-3005 (M-F 8AM-10PM EST, Sat 9AM-7PM EST)

Visit our Website at: leviton.com/commercialswitches email: commercial@leviton.com