



ENCLOSURES

THREADED ENCLOSURES



ATEX / IEC Ex Certified

Class I, Div. 1 & 2, Groups B, C, D
Class I, Zones 1 & 2, Groups IIB+H2, IIA
Class II, Div. 1 & 2, Groups E, F, G
Class III, Div. 1 & 2
ENCL Type 3, 4 & 4X
ATEX/IEC Ex
Ex d IIC T6 or T5
Ex tD A21 IP66 T80°C or T90°C IP66
Ta = -20°C to +60°C

- #UL886 - Outlet Boxes and Fittings for use in Hazardous (Classified) Locations. File #E10514
- #UL1203 - Explosion Proof and Dust Ignition Proof Electrical Equipment. File #E83969
- #C22.2 No. 30-M1986 - Explosion Proof Enclosure for use in Class I Hazardous Locations. File #LR11716
- #3600 & 3615 File #2Y4A5.AE
- II 2 G/D 0518 PTB 02 ATEX 1071U (Empty Housing)
PTB 02 ATEX 1072 (Enclosure with Controls)
IEC Ex PTB 05 0029
IEC Ex PTB 05.0028U

FEATURES-SPECIFICATIONS

Applications

- Hazardous locations due to the presence of flammable gases or vapors, combustible dusts or easily ignitable fibers or flyings, and areas which are subject to corrosion, weather and dampness
- Installations at petroleum refineries, chemical and petrochemical plants, storage areas, and other processing facilities where hazardous substances are handled or stored
- Applications requiring junction, pull and/or splice boxes
- Enclosures to house meters, relays, terminal strips, control transformers, etc.

- **Global applications* (ATEX/IEC Ex) Enclosures are available for global applications with "CEN" suffix. Assemblies that are modified to ATEX/IEC Ex standards maintain their North American certifications.**

Features

- Compact square or rectangular enclosures with threaded screw type covers provide easy access to interior
- Can be shipped in component parts and still maintain third party UL-CSA-FM approvals
- Available in three different cover types, flat blank, lens and dome covers
- Cast mounting lugs are standard on all assemblies
- Available as blank box or can be custom drilled and tapped for conduit openings which may be factory or field installed on the four sides or back wall
- Gaskets are standard on all assemblies and with covers when component part ordering
- Internal ground screw supplied on all boxes
- CEN suffix modification for CENELEC Certification includes an external ground screw, cover locking screw, and nameplate displaying certification and area classifications. Feature is only available on complete assemblies and not available when component part ordering.

Material/Finish

- Enclosures:
Copper-free Aluminum

(less than 4/10 of 1%)

- Optional Mounting Pans:
Sheet Aluminum
- Lens Cover Glass:
Tempered soda lime glass
- Cover Gaskets:
GRB, GRE, GRM, GRK, GRL
70 Durometer NITRILE
GRH, GRHA, GRHC
57 63 Durometer BUNA-N
- Electrostatically applied gray powder epoxy/polyester finish on exterior of box and cover



THREADED ENCLOSURES

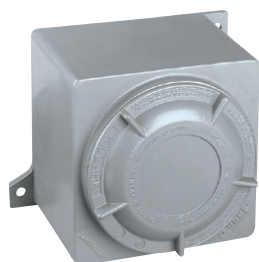

Box with blank cover

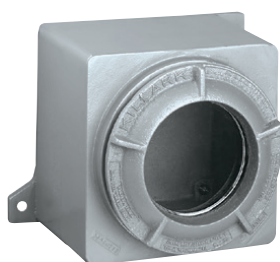

Box with lens cover



Box with dome cover

NOTE: See Page E46 for Third Party Certifications

FEATURES-SPECIFICATIONS

GR COMPLETE ASSEMBLIES									
COVER OPENING DIAMETER	NOMINAL EXTERNAL BOX DIMENSIONS WITHOUT COVER			CATALOG NUMBER		VIEWING AREA	CATALOG NUMBER	DEPTH OF DOME	MAXIMUM CONDUIT SIZE
	L	W	D	BOX WITH BLANK COVER	BOX WITH LENS COVER		BOX WITH DOME COVER		
3.906 (99.21)	4.63 (117.60)	4.63 (117.60)	4.15 (105.41)	GRB	GRB-275L	2.75 (70)	2GRB	2 (51)	1-1/2"
							4GRB	4 (102)	
4.34 (110.24)	6.63 (168.40)	5.5 (139.70)	5.25 (133.35)	GRE	GRE-300L	3 (76)	—	—	2"
5.28 (134.11)	6.87 (174.50)	6.87 (174.50)	5.93 (150.62)	GRM	GRM-375L	3.75 (95)	5GRM	5 (127)	2"
7.25 (184.15)	9.87 (250.70)	8.38 (212.85)	6.53 (165.86)	GRK	GRK-537L	5.38 (137)	4GRK	4 (102)	2-1/2"
7.87 (199.90)	10.5 (266.70)	8.87 (225.30)	7.18 (182.37)	GRL	GRL-600L	6 (152)	—	—	2"
9.63 (244.60)	12 (304.80)	11 (279.40)	7.63 (193.80)	GRH	GRH-775L	7.75 (197)	4GRH	4 (102)	3 1/2"
							8GRH	8 (203)	
9.63 (244.60)	12.18 (309.37)	11 (279.40)	11 (279.40)	GRHC	GRHC-775L	7.75 (197)	4GRHC	4 (102)	4"
							8GRHC	8 (203)	
9.63 (244.60)	12 (304.80)	11 (279.40)	16.18 (410.97)	GRHA	GRHA-775L	7.75 (197)	4GRHA	4 (102)	4"
							8GRHA	8 (203)	

NOTE: To order above items with ATEX IEC EX Modifications and Certifications add suffix CEN to end of catalog number. (Example: GRBCEN)
To order above items with a flat back pan installed add suffix P to catalog number.

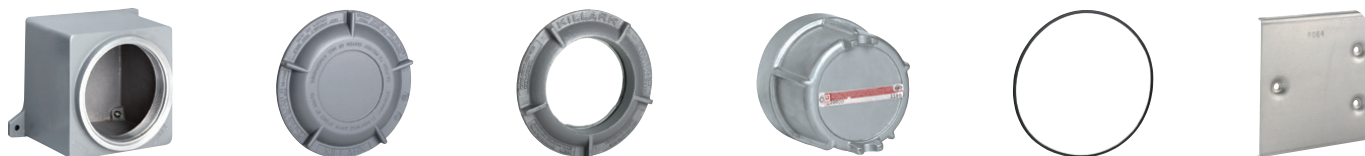

GR COMPONENT PARTS							
ENCLOSURE SERIES	CATALOG NUMBER OF COMPONENTS						
	BOX WITHOUT COVER	BLANK COVER	LENS COVER	DOME COVER	GASKET REPLACEMENT	FLAT PAN	DIMENSIONS FOR MTG. PANS
GRB	GRBB	GRB-BC	GL-275	2"- 2GRBD	GRB-RG	6086PAN	3.4 x 3.5 (86 x 89)
				4"- 4GRBD			
GRE	GREB	GRE-BC	GL-300	—	GRE-RG	6074	4 x 4.5 (102 x 114)
GRM	GRMB	GRM-BC	GL-375	5"- 5GRMD	GRM-RG	6064	5 x 5 (127 x 127)
GRK	GRKB	GRK-BC	GL-537	4"- 4GRKD	GRK-RG	6038	5.5 x 7.5 (140 x 191)
GRL	GRLB	GRL-BC	GL-600	—	GRL-RG	6053	6 x 8.5 (152 x 216)
GRH	GRHB	GRH-BC	GL-775	4"- 4GRHD	GRH-RG	6058	8 x 9 (203 x 229)
				8"- 8GRHD			
GRHC	GRHCB	GRH-BC	GL-775	4"- 4GRHD	GRH-RG	6058	8 x 9 (203 x 229)
				8"- 8GRHD			
GRHA	GRHAB	GRH-BC	GL-775	4"- 4GRHD	GRH-RG	6058	8 x 9 (203 x 229)
				8"- 8GRHD			

NOTES: Covers are supplied with gasket.
For Group B locations all conduits must be sealed within 18" of enclosures.



THREADED ENCLOSURES

CAT. NO.	MTG DIM			INTERNAL									
	A	B	C	D	E	F	G*	H	I	J	K	L	+M
GRB	4 (101.6)	6 (152.4)	0.31 (7.9)	4.63 (117.6)	4.63 (117.6)	4.15 (105.4)	3.91 (99.3)	4.56 (115.8)	4.53 (115.1)	3.75 (95.3)	3.75 (95.3)	2.68 (68.1)	2.75 (69.9)
GRE	5.75 (146.1)	6.5 (165.1)	0.31 (7.9)	6.63 (168.4)	5.5 (139.7)	5.25 (133.4)	4.34 (110.2)	5.75 (146.1)	5.72 (145.3)	4.63 (117.6)	5.75 (146.1)	3.28 (83.3)	3 (76.2)
GRM	5.87 (149.1)	8.13 (206.5)	0.31 (7.9)	6.87 (174.5)	6.87 (174.5)	5.93 (150.6)	5.28 (134.1)	6.56 (166.6)	6.56 (166.6)	6 (152.4)	6 (152.4)	4.18 (106.2)	3.75 (95.3)
GRK	9.13 (231.9)	9.63 (244.6)	0.31 (7.9)	9.87 (250.7)	8.38 (212.9)	6.53 (165.9)	7.25 (184.2)	7.28 (184.9)	7.18 (182.4)	7.06 (179.3)	8.31 (211.1)	4.13 (104.9)	5.38 (136.7)
GRL	9.5 (241.3)	10.5 (266.7)	0.44 (11.2)	10.5 (266.7)	8.87 (225.3)	7.18 (182.4)	7.87 (199.9)	7.97 (202.4)	7.93 (201.4)	7.63 (193.8)	9.13 (231.9)	4.93 (125.2)	6 (152.4)
GRH	10.75 (273.1)	12.13 (308.1)	0.44 (11.2)	12 (304.8)	11.63 (295.4)	7.63 (193.8)	9.63 (244.6)	8.38 (212.9)	8.63 (219.2)	9.5 (241.3)	10.5 (266.7)	5 (127.0)	7.75 (196.9)
GRHA	8.25 (209.6)	12.13 (308.1)	0.44 (11.2)	12 (304.8)	11.63 (295.4)	16.18 (411.0)	9.63 (244.6)	16.93 (430.0)	17.18 (436.4)	9.5 (241.3)	10.5 (266.7)	13.56 (344.4)	7.75 (196.9)
GRHC	8.25 (209.6)	12.13 (308.1)	0.56 (14.2)	12.18 (309.4)	11.63 (295.4)	11 (279.4)	9.63 (244.6)	11.75 (298.5)	12 (304.8)	9.56 (242.8)	10.63 (270.0)	8.43 (214.1)	7.75 (196.9)

CATALOG NUMBER BASIC BOX W/DOME COVER	S DIM INCHES (MM)
2GRB	7 (177.80)
4GRB	9 (228.60)
5GRM	12.25 (311.15)
4GRK	11.93 (303.02)
4GRH	13 (330.20)
8GRH	17 (431.80)
4GRHA	21.5 (546.10)
8GRHA	25.5 (647.70)
4GRHC	16.31 (414.27)
8GRHC	20.31 (515.88)

NOTE: GRH has four lugs with holes. GRHA & GRHC has four lugs with slots.

* Box Opening

+ Lens Viewing

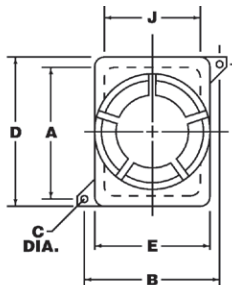

GRB GRK
GRE GRL
GRM

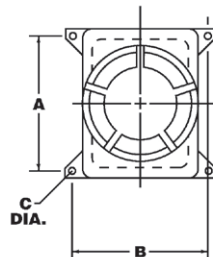

GRH
GRHA
GRHC

Dimensions

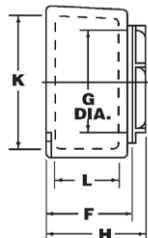

Blank Cover

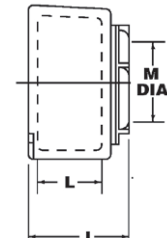

Lens Cover

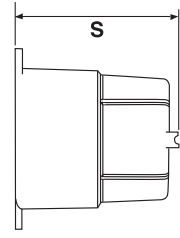

Dome Cover

GR MODIFICATIONS	
SUFFIX NUMBER	DESCRIPTION
SU3B-4X	Drain and breather Groups B, C, D, Type 4X
SU3ATEX	ATEX/IEC Ex Drain and breather*
P	Internal flat mounting pan installed
CEN	ATEX/IEC Ex modification and certification (complete box & cover assembly only)
SU8	Drill for pan mounting studs without pan
SU6	Removal of external mounting lugs

- SU3B-4x are not ATEX/IECEx approved
- SU3-ATEX voids Type 4, 4X and IP66 rating

*See Drain / Breather Catalog Page

Drilled & Tapped Conduit Openings

Boxes are furnished blank for field drilling and tapping of conduit openings. If factory openings are requested submit drawing or select from charts below.

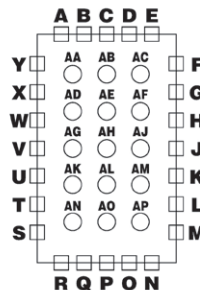

SYMBOL NUMBER	
SIZE	SYMBOL
1/2"	1
3/4"	2
1"	3
1-1/4"	4
1-1/2"	5
2"	6
2-1/2"	7
3"	8
3-1/2"	9
4"	10

EXAMPLE: GRB-C3-J2-P1=
GRB enclosure with 1" NPT top center,
3/4" NPT right side center,
1/2" NPT bottom center

GR ENCLOSURE VOLUMES	
CATALOG NUMBER	VOLUME CU IN (LT)
GRB	45 (0.74)
GRE	105 (1.72)
GRM	180 (2.95)
GRK	305 (5.00)
GRL	405 (6.64)
GRH	615 (10.09)
GRHA	1450 (23.78)
GRHC	985 (16.15)
GRB-275L	40 (0.66)
GRE-300L	95 (1.56)
GRM-375L	170 (2.79)
GRK-537L	280 (4.59)
GRL-600L	380 (6.23)
GRH-775L	570 (9.35)
GRHA-775L	1400 (22.96)
GRHC-775L	940 (15.42)
2GRB	60 (0.98)
4GRB	80 (1.31)
5GRM	250 (4.10)
4GRK	410 (6.72)
4GRH	820 (13.45)
8GRH	1050 (17.22)
4GRHA	1660 (27.22)
8GRHA	1890 (31.00)
4GRHC	1195 (19.60)
8GRHC	1425 (23.37)





GR SERIES

KILLARK

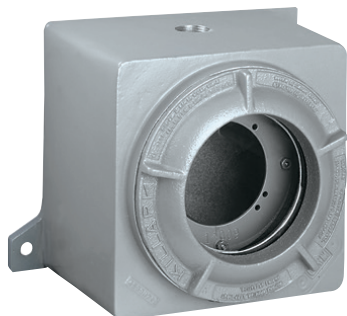
INSTRUMENT ENCLOSURES



Class I, Div. 1 & 2, Groups B,C,D
 Class I, Zones 1 & 2, Groups IIB+H2, IIA
 Class II, Div. 1 & 2, Groups E, F, G
 Class III, Div. 1 & 2
 ENCL. Type 3, 4, & 4X

-  #UL1203 - Explosion Proof and Dust Ignition Proof Electrical Equipment. File #E83969
-  #C22.2 No. 30-M1986 -Explosion Proof Enclosure for use in Class I Hazardous Locations. File #LR11716
-  #3600 & 3615 File #2Y4A5.AE

FEATURES-SPECIFICATIONS

Applications

Use GR Series Instrument Enclosures for mounting of 3", 3-1/2", 4" or 4-1/2" round or rectangular instruments such as ammeters and voltmeters

- Two 3/4"-14 NPT drilled and tapped conduit openings, one top and one bottom, are standard
- Internal mounting pan is attached to inside back of box with spacers for mounting meter

GR INSTRUMENT ENCLOSURES (INSTRUMENTS NOT SUPPLIED)				
CATALOG NUMBER	MANUFACTURER	INSTRUMENT		
		MODEL	SIZE	TYPE
GRM-375L52	Weston	1930 Series	3-1/2"	Rectangular
		301 Series	3"	Rectangular
		301 Series	3-1/2"	Round
GRM-375L52	General Electric	KT w/o reset	3"	Rectangular
		KT w/o reset	3-1/2"	Round
GRM-375L52	Cutler Hammer	R-351	3"	Rectangular
		B-351 w/o reset	3"	Rectangular
		N-351	3-1/2"	Round
GRM-375L52	Simpson	27, 27T, 37, 47, 57, 77 Series	3"	Rectangular
		2100 Series	3-1/2"	Rectangular
		25, 25T, 35, 45, 55 Series	3-1/2"	Round
		55ET	3-1/2"	Round
		75	3-1/2"	Round
		1300 Series	3-1/2"	Rectangular
		3223	3-1/2"	Round
3323	3-1/2"	Rectangular		
GRM-375L52	Cutler Hammer	N-371 Series	4-1/2"	Round
GRK-537L52A	Cutler Hammer	R-371 Series	4"	Rectangular
GRK-537L52A	Simpson	3224	4-1/2"	Round
GRK-537L52A	General Electric	250, 162, 167, 251 Series	3-1/2"	Rectangular
		178 Series	4-1/2"	Rectangular
		171 Series frequency meter	4-1/2"	Rectangular
		236 w/o Reset	3-1/2"	Rectangular
GRK-537L52B	Weston	1940 Series	4-1/2"	Rectangular
GRK-537L52B	General Electric	AB/DB-30 AC ammeter	4-1/2"	Rectangular
		AB/DB-30 AC/DC ammeter	4-1/2"	Rectangular
GRL-600L52B	General Electric	AB/DB-40 AC ammeter	4-1/2"	Rectangular
GRK-537L52B	General Electric	DB-40 DC ammeter	4-1/2"	Rectangular
		DB-40 DC voltmeter	4-1/2"	Rectangular
		171, 250, 251 Series	4-1/2"	Rectangular
GRL-600L52C	Simpson	29, 29T, 39, 49, 59, 79, 1300, 2100 Series	4-1/2"	Rectangular
GRH-775L52B	General Electric	AB/DB-40 AC voltmeter	4-1/2"	Rectangular



ENCLOSURES

INSTRUMENT ENCLOSURES

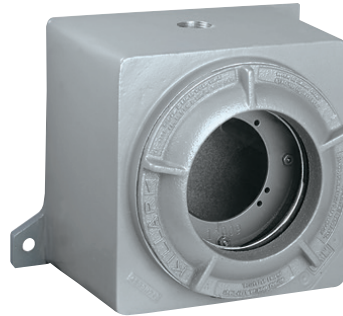

FEATURES-SPECIFICATIONS

GR DIMENSIONS									
CATALOG NUMBER	FIG. NO.	A	B	C	D	E	G	H	I
GRM-375L52	1	5-7/8"	8-1/8"	5/16"	6-7/8"	6-7/8"	3-9/16"	6-13/32"	2-5/8"
GRK-537L52A	1	9-1/8"	9-1/8"	5/16"	9-7/8"	7-7/8"	4-7/8"	6-11/16"	2-1/2"
GRK-537L52B	1	9-1/8"	9-1/8"	5/16"	9-7/8"	7-7/8"	4-7/8"	6-11/16"	2-1/2"
GRL-600L52B	1	9-1/2"	10-1/2"	7/16"	10-1/2"	8-7/8"	5-13/16"	7-17/32"	2-3/4"
GRL-600L52C	1	9-1/2"	10-1/2"	7/16"	10-1/2"	8-7/8"	5-13/16"	7-17/32"	2-3/4"
GRH-775L52B	2	10-3/4"	12-1/8"	7/16"	12"	11"	7-7/16"	8-3/4"	3"

Dimensions

Figure 1

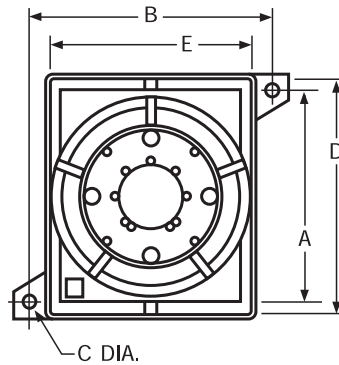

Figure 2

