



FLEX I/O 2 Input Frequency Module Cat. No. 1794-IJ2, 1794-IJ2K, and 1794-IJ2XT

(Modules with a K in the last position of the catalog number are conformally coated to meet noxious gas requirements of ISA/ANSI-71.040 1985 Class G3 Environment.)

Important User Information

Solid state equipment has operational characteristics differing from those of electromechanical equipment. *Safety Guidelines for the Application, Installation and Maintenance of Solid State Controls* (Publication [SGI-1.1](#) available from your local Rockwell Automation sales office or online at <http://literature.rockwellautomation.com>) describes some important differences between solid state equipment and hard-wired electromechanical devices. Because of this difference, and also because of the wide variety of uses for solid state equipment, all persons responsible for applying this equipment must satisfy themselves that each intended application of this equipment is acceptable.



In no event will Rockwell Automation, Inc. be responsible or liable for indirect or consequential damages resulting from the use or application of this equipment.

The examples and diagrams in this manual are included solely for illustrative purposes. Because of the many variables and requirements associated with any particular installation, Rockwell Automation, Inc. cannot assume responsibility or liability for actual use based on the examples and diagrams.

No patent liability is assumed by Rockwell Automation, Inc. with respect to use of information, circuits, equipment, or software described in this manual.

Reproduction of the contents of this manual, in whole or in part, without written permission of Rockwell Automation, Inc. is prohibited.

Throughout this manual we use notes to make you aware of safety considerations.

	WARNING Identifies information about practices or circumstances that can cause an explosion in a hazardous environment, which may lead to personal injury or death, property damage, or economic loss.
	IMPORTANT Identifies information that is critical for successful application and understanding of the product.
	ATTENTION Identifies information about practices or circumstances that can lead to personal injury or death, property damage, or economic loss. Attentions help you: <ul style="list-style-type: none"> • identify a hazard • avoid a hazard • recognize the consequence

	ATTENTION Environment and Enclosure This equipment is intended for use in a Pollution Degree 2 industrial environment, in overvoltage Category II applications (as defined in IEC publication 60664-1), at altitudes up to 2000 meters (6562 ft) without derating. This equipment is considered Group 1, Class A industrial equipment according to IEC/CISPR Publication 11. Without appropriate precautions, there may be potential difficulties ensuring electromagnetic compatibility in other environments due to conducted as well as radiated disturbance. This equipment is supplied as open-type equipment. It must be mounted within an enclosure that is suitably designed for those specific environmental conditions that will be present and appropriately designed to prevent personal injury resulting from accessibility to live parts. The enclosure must have suitable flame-retardant properties to prevent or minimize the spread of flame, complying with a flame spread rating of 5VA, V2, V1, V0 (or equivalent) if non-metallic. The interior of the enclosure must be accessible only by the use of a tool. Subsequent sections of this publication may contain additional information regarding specific enclosure type ratings that are required to comply with certain product safety certifications. In addition to this publication, see: <ul style="list-style-type: none"> • Industrial Automation Wiring and Grounding Guidelines, for additional installation requirements, Allen-Bradley publication 1770-4.1. • NEMA Standards publication 250 and IEC publication 60529, as applicable, for explanations of the degrees of protection provided by different types of enclosure.
---	---

WARNING
 If you insert or remove the module while backplane power is on, an electrical arc can occur. This could cause an explosion in hazardous location installations.
Be sure that power is removed or the area is nonhazardous before proceeding.

WARNING
 If you connect or disconnect wiring while the field-side power is on, an electrical arc can occur. This could cause an explosion in hazardous location installations. Be sure that power is removed or the area is nonhazardous before proceeding.

ATTENTION
 Personnel responsible for the application of safety-related Programmable Electronic Systems (PES) shall be aware of the safety requirements in the application of the system and shall be trained in using the system.

ATTENTION
 Do not remove or replace a Terminal Base unit while power is applied. Interruption of the backplane can result in unintentional operation or machine motion.

ATTENTION
 FLEX I/O is grounded through the DIN rail to chassis ground. Use zinc plated yellow-chromate steel DIN rail to assure proper grounding. The use of other DIN rail materials (for example, aluminum or plastic) that can corrode, oxidize, or are poor conductors, can result in improper or intermittent grounding. Secure DIN rail to mounting surface approximately every 200 mm (7.8 in.) and use end-anchors appropriately.

ATTENTION
 **Preventing Electrostatic Discharge**

This equipment is sensitive to electrostatic discharge, which can cause internal damage and affect normal operation. Follow these guidelines when you handle this equipment:

- Touch a grounded object to discharge potential static.
- Wear an approved grounding wriststrap.
- Do not touch connectors or pins on component boards.
- Do not touch circuit components inside the equipment.
- Use a static-safe workstation, if available.
- Store the equipment in appropriate static-safe packaging when not in use.

ATTENTION
 To reduce susceptibility to noise, power analog modules and digital modules from separate power supplies. Do not exceed a total length of 9.8 ft (3m) for dc power cabling.

European Hazardous Location Approval
The following frequency input modules are European Zone 2 approved: 1794-IJ2, 1794-IJ2K, and 1794-IJ2XT

European Zone 2 Certification (The following applies when the product bears the Ex or EEx Marking)

This equipment is intended for use in potentially explosive atmospheres as defined by European Union Directive 94/9/EC and has been found to comply with the Essential Health and Safety Requirements relating to the design and construction of Category 3 equipment intended for use in potentially explosive atmospheres, given in Annex II to this Directive. Compliance with the Essential Health and Safety Requirements has been assured by compliance with EN 60079-15 and EN 60079-0.

WARNING



Observe the following additional Zone 2 certification requirements.

- This equipment is not resistant to sunlight or other sources of UV radiation.
- This equipment must be installed in an enclosure providing at least IP54 protection when applied in Zone 2 environments.
- This equipment shall be used within its specified ratings defined by Allen-Bradley.
- Provision shall be made to prevent the rated voltage from being exceeded by transient disturbances of more than 40% when applied in Zone 2 environments.
- Secure any external connections that mate to this equipment by using screws, sliding latches, threaded connectors, or other means provided with this product.
- Do not disconnect equipment unless power has been removed or the area is known to be nonhazardous.

ATTENTION



To comply with the CE Low Voltage Directive (LVD), all connections to this equipment must be powered from a source compliant with the following: Safety Extra Low Voltage (SELV) or Protected Extra Low Voltage (PELV).

North American Hazardous Location Approval

The following frequency input modules are North American Hazardous Location approved: 1794-IJ2, 1794-IJ2K, and 1794-IJ2XT.

The following information applies when operating this equipment in hazardous locations:		Informations sur l'utilisation de cet équipement en environnements dangereux :	
<p>Products marked "CL I, DIV 2, GP A, B, C, D" are suitable for use in Class I Division 2 Groups A, B, C, D, Hazardous Locations and nonhazardous locations only. Each product is supplied with markings on the rating nameplate indicating the hazardous location temperature code. When combining products within a system, the most adverse temperature code (lowest "T" number) may be used to help determine the overall temperature code of the system. Combinations of equipment in your system are subject to investigation by the local Authority Having Jurisdiction at the time of installation.</p>		<p>Les produits marqués "CL I, DIV 2, GP A, B, C, D" ne conviennent qu'à une utilisation en environnements de Classe I Division 2 Groupes A, B, C, D dangereux et non dangereux. Chaque produit est livré avec des marquages sur sa plaque d'identification qui indiquent le code de température pour les environnements dangereux. Lorsque plusieurs produits sont combinés dans un système, le code de température le plus défavorable (code de température le plus faible) peut être utilisé pour déterminer le code de température global du système. Les combinaisons d'équipements dans le système sont sujettes à inspection par les autorités locales qualifiées au moment de l'installation.</p>	
<p>WARNING</p>	<p>EXPLOSION HAZARD</p> <ul style="list-style-type: none"> • Do not disconnect equipment unless power has been removed or the area is known to be nonhazardous. • Do not disconnect connections to this equipment unless power has been removed or the area is known to be nonhazardous. Secure any external connections that mate to this equipment by using screws, sliding latches, threaded connectors, or other means provided with this product. • Substitution of components may impair suitability for Class I, Division 2. • If this product contains batteries, they must only be changed in an area known to be nonhazardous. 	<p>AVERTISSEMENT</p>	<p>RISQUE D'EXPLOSION</p> <ul style="list-style-type: none"> • Couper le courant ou s'assurer que l'environnement est classé non dangereux avant de débrancher l'équipement. • Couper le courant ou s'assurer que l'environnement est classé non dangereux avant de débrancher les connecteurs. Fixer tous les connecteurs externes reliés à cet équipement à l'aide de vis, loquets coulissants, connecteurs filetés ou autres moyens fournis avec ce produit. • La substitution de composants peut rendre cet équipement inadéquat à une utilisation en environnement de Classe I, Division 2. • S'assurer que l'environnement est classé non dangereux avant de changer les piles.

Installing Your Frequency Input Module

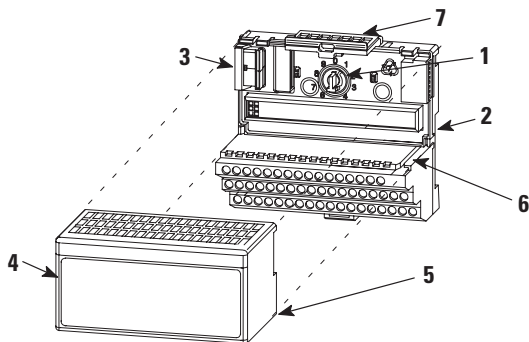

ATTENTION



During mounting of all devices, be sure that all debris (metal chips, wire strands, etc.) is kept from falling into the module. Debris that falls into the module could cause damage on power up.

The module mounts on a 1794-TB3G or -TB3GS terminal base.

1. Rotate the keyswitch (1) on the terminal base (2) clockwise to position 1 as required for this type of module.
2. Make certain the flexbus connector (3) is pushed all the way to the left to connect with the neighboring terminal base/adaptor. **You cannot install the module unless the connector is fully extended.**
3. Make sure the pins on the bottom of the module are straight so they will align properly with the connector in the terminal base.

WARNING



If you remove or insert the module while the backplane power is on, an electrical arc can occur. This could cause an explosion in hazardous location installations. Be sure that power is removed or the area is nonhazardous before proceeding.

4. Position the module (4) with its alignment bar (5) aligned with the groove (6) on the terminal base.
5. Press firmly and evenly to seat the module in the terminal base unit. The module is seated when the latching mechanism (7) is locked into the module.

Connecting Wiring for the 1794-TB3G, and -TB3GS

ATTENTION



To reduce susceptibility to noise, power analog modules and digital modules from separate power supplies. Do not exceed a length of 3 m (9.8 ft) for DC power cabling.

ATTENTION



Do not daisy chain power or ground from this terminal base unit to any AC or DC digital module terminal base units.

Connect wiring as shown here.

Wiring Connections for the Frequency Input Module using the 1794-TB3G or -TB3GS Terminal Base Unit

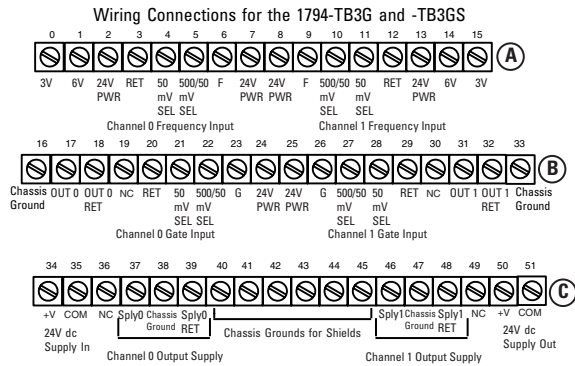

+24V dc = Terminals C-34 and C-50 (1794-TB3G shown)
 COM = C-35 and C-51
 Chassis Ground = Terminals B-16, B-33, C-38, C-40 thru 45, and C-47
 NC = No connection
 For daisy-chaining: Supply in - C-34 (+) and C-35 (-)
 Supply out - C-50 (+) and C-51 (-)

Output Alarm Connections	Channel 0 Terminals ¹				Channel 1 Terminals ¹			
	Sply +	Sply RET	Out +	Out RET	Sply +	Sply RET	Out +	Out RET
Supply	C-37	C-39			C-46	C-48		
Output			B-17	B-18			B-31	B-32

¹ Connect cable shields to GND connections.

Types of Inputs	Channel 0 Terminals ⁵			Channel 1 Terminals ⁵			GND ⁵
	Power	Input	RET ⁶	Power	Input	RET ⁶	
Frequency							
24V DC IEC 1+ Proximity ^{1,2}	A-7	A-6	A-3	A-8	A-9	A-12	
24V DC Contact Switch ³	A-7	A-6	A-3	A-8	A-9	A-12	
500 mV AC Magnetic Pickup	A-7	A-5	A-3	A-8	A-10	A-12	
50 mV AC Magnetic Pickup ⁴	A-7	A-5	A-3	A-8	A-10	A-12	
6V AC Vortex	A-2	A-1	A-3	A-13	A-14	A-12	
3V AC Vortex	A-2	A-0	A-3	A-13	A-15	A-12	
Gate							
24V DC IEC 1+ Proximity ^{1,2}	B-24	B-23	B-20	B-25	B-26	B-29	
24V DC Contact Switch ³	B-24	B-23	B-20	B-25	B-26	B-29	
500 mV DC Magnetic Pickup	B-24	B-22	B-20	B-25	B-27	B-29	
50 mV DC Magnetic Pickup ⁴	B-24	B-22	B-20	B-25	B-27	B-29	

1 As defined by standard IEC 1131-2.
 2 RET not used on 2-wire devices.
 3 Add external resistor from 24V to F (A-6) or G (A-9) for wire-off detection (0.4 mA).
 4 Add jumper between 50 mV and RET (frequency - channel 0 = A-4 to A-3; channel 1 = A-11 to A-12)
 (gate - channel 0 = B-21 to B-20; channel 1 = B-28 to B-29).
 5 Connect cable shields to GND terminals.
 6 All 4 RET terminals (ch0 and 1, Freq. and Gate) are internally connected together.

Resolution and Accuracy

±1Hz or ±0.1Hz (depending on frequency range bit setting), or ± accuracy specification listed below, whichever is greater.

Resolution % is defined as:

$$\% \text{ Resolution} = \frac{100}{\text{count frequency} \times \text{minimum frequency sample time}}$$

Accuracy % is defined as:

$$\% \text{ Accuracy} = 100 \left[1 - \frac{\text{minimum frequency sample time}}{2} + \frac{1}{\text{count frequency}} \right]$$

Min. Freq. Sample Time (ms)	Accuracy					Resolution
	Sampling Accuracy	Time Base Accuracy	Worst Case Total Accuracy	Deviation in Hz Due to Total Accuracy		
				1.0-3276.7 Freq. Range (in Hz)	1-32767 Freq. Range (in Hz)	
2	±0.02%	±0.0225%	±0.0425	±0.1-1.4	±1-14	0.01%
4	±0.01%	±0.0225%	±0.0325	±0.1-1.1	±1-11	0.005%
5	±0.008%	±0.0225%	±0.0305	±0.1-1.0	±1-10	0.004%
10	±0.004%	±0.0225%	±0.0265	±0.1-0.9	±1-9	0.002%
20	±0.002%	±0.0225%	±0.0245	±0.1-0.8	±1-8	0.001%
50	±0.0008%	±0.0225%	±0.0233	±0.1-0.8	±1-8	0.0004%
100	±0.0004%	±0.0225%	±0.0229	±0.1-0.8	±1-8	0.0002%
200	±0.0002%	±0.0225%	±0.0227	±0.1-0.7	±1-7	0.0001%
500	±0.00008%	±0.0225%	±0.02258	±0.1-0.7	±1-7	0.00004%
1000	±0.00004%	±0.0225%	±0.02254	±0.1-0.7	±1-7	0.00002%

Input Map

Bit	15	14	13	12	11	10	09	08	07	06	05	04	03	02	01	00
⇒	R	R														
Word	Read															
0	Frequency 0...32,767 or 0.0...3,276.7 Channel 0															
1	% Full Scale 0.0...3,276.7% Channel 0 or Acceleration -32,768...32,767 Channel 0															
2	Frequency 0...32,767 or 0.0...3,276.7 Channel 1															
3	% Full Scale 0.0...3,276.7% Channel 1 or Acceleration -32,768...32,767 Channel 1															
4	R	R	Direction Ch 0	GS Ch 0	F/A Ch 0	WO Ch 0	MPA Ch 0	R	R	Direction Ch 1	GS Ch 1	F/A Ch 1	WO Ch 1	MPA Ch 1		
5	Reserved						Diagnostic Status Channel 0			Reserved			Diagnostic Status Channel 1			
6	Reserved															

Where:
 GS = Gate state
 F/A = Frequency/Accel alarm
 WO = Wire-off alarm
 MPA = Missing pulse alarm
 R = Reserved

Output Map

Dec	15	14	13	12	11	10	9	8	7	6	5	4	3	2	1	0
Oct.	17	16	15	14	13	12	11	10	7	6	5	4	3	2	1	0
0	CF	SSM	FR Ch 0	Number of pulses to terminate sampling 0-7 Ch 0			MPM0-3 Ch 0	R	LF	FR Ch 1	Number of pulses to terminate sampling 0-7 Ch 1			MPM 0-3 Ch 1		
1	Maximum Frequency 0 - 32,767 or 0.0 - 3,276.7 - or - Absolute Value of Acceleration - 0 to 32,767 Channel 0															
2	Frequency Scaling Divisor 0-255 Channel 0								Frequency Scaling Multiplier 0-255 Channel 0							
3	WOF G Ch 0	WOF F Ch 0	IGI Ch 0	IFI Ch 0	Minimum Frequency Sample Time 0-15 Ch 0			Init St Up Ch 0	ACT 0-3 Ch 0	F/AA S Ch 0	MPDM 0-3 Ch 0	WOFM 0-3 Ch 0				
4	Maximum Frequency 0 - 32,767 or 0.0 - 3,276.7 - or - Absolute Value of Acceleration - 0 to 32,767 Channel 1															
5	Frequency Scaling Divisor 0-255 Channel 1								Frequency Scaling Multiplier 0-255 Channel 1							
6	WOF G Ch 1	WOF F Ch 1	IGI Ch 1	IFI Ch 1	Minimum Frequency Sample Time 0-15 Ch 1			Init St Up Ch 1	ACT 0-3 Ch 1	F/AA S Ch 1	MPDM 0-3 Ch 1	WOFM 0-3 Ch 1				
7	Reserved															

Where:CF = Communication Fault
 SSM = Safe state mode
 FR = Frequency range
 MPM = Missing pulse multiplier
 LF = Local Fault mode
 F/AA S = Frequency/Accel alarm select
 WOFF = Wire-off fault frequency
 WOFG = Wire-off fault gate
 WOFM = Wire-off fault mode
 IGI = Invert gate input
 IFI = Invert frequency input
 ACT = Acceleration calculation time
 MPDM = Missing pulse delay multiplier
 R = Reserved

Status Indicators

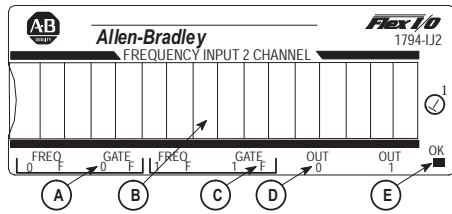

- A = Input indicator.
- B = Insertable label for writing individual I/O assignments.
- C = Wire-Off Fault indicator.
- D = Output indicator.
- E = Power/status indicator - indicates power applied to module and status of module.

1794-IJ2 shown

When an input indicator (yellow) is lighted, it indicates that a valid signal (active high or active low) is present at one of the Input terminals. When wire-off detection is enabled, and a wire-off fault is detected (24 V DC IEC 1+ input terminal only), a fault indicator (red) is blinked/flushed at a rate of 1Hz to signal a fault condition. A wire-off fault signal will also be sent to the backplane. A flashing red fault indication means a valid wire-off condition for a 24 V DC IEC 1+ Input or a 24 V DC contact switch input with a shunt resistor.

When an output indicator is yellow, the logic is driving an output alarm On. After detecting a fault, the internal circuitry will set the output data to the appropriate safe state, as defined by the module data table. Safe state control may be adapter dependent. The input and output indicators are on the field side of the isolation path, and display the logic state of the actual microcontroller input and output.

The status indicator initially powers up as solid green, indicating the power supply is operating and internal diagnostic tests are being performed. After a successful power up test, the indicator remains green. The indicator turns red in about 1.5 s if there is an internal diagnostics error. The module is operating correctly when the green OK indicator is on. A red OK indicator shows that the module is in a Faulted condition (internal error).

Indicator	Condition	Operating Description
Input (0, 1) (Freq, or Gate)	Off (Dark)	Input Turned Off, Input Not Used, or Wire Disconnected
	On (Yellow)	Input Turned On (Active High or Active Low if Inverted)
Fault (F) (Freq, or Gate)	Off (Dark)	Wire Connected, Normal Operation or Detection Disabled
	On (Red Flashing)	Wire Disconnected, Fault Condition (for IEC 1+ Proximity switch or switch contacts with shunt resistor)
Output Alarm (0, 1)	Off (Dark)	Output Alarm Turned Off
	On (Yellow)	Output Alarm Turned On (Logic Drive On)
Status (OK)	Off (Dark)	24V Power Turned Off, or 5V Logic Power Problem
	Solid Green	Module OK, Normal Operating Mode
	Solid Red	Module Fault, Outputs Disabled

Diagnostics

The frequency input module returns diagnostics to the PLC processor in word 5 of the BTR file. These diagnostics give you information on the status or condition of the module.

BTR Word 5

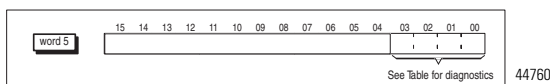

Input Word	Bit	Definition	
Word 5	Bits 00 - 03	Diagnostic Status - indicates the response from the module; a normal or non-normal operating condition.	
		Bit	
		03 02 01 00	
		0 0 0 0	0 = Normal Operation (No Failure)
		0 0 0 1	1 = Calibration Failure
		0 0 1 0	2 = Configuration Failure A Minimum Frequency Sample Time value other than 0-9 was selected.
		0 0 1 1	3 = Message Failure
		0 1 0 0	4 = Lead Break Detection Hardware Failure
		0 1 0 1	5 = Major Hardware Failure
		0 1 1 0	6 = EEPROM Failure
		0 1 1 1	7 = RAM Failure
		1 0 0 0	8 = ROM Failure
		1 0 0 1	9 = Calculation Failure The actual Frequency is greater than 32,767 Hz or 3,276.7 Hz (overage). The scaled Frequency is greater than 32,767 Hz or 3,276.7 Hz (overage). The % Full Scale calculation (based on Maximum Frequency) is > 3,276.7%.
		1010 - 1111	10 - 15 = Not used

Specifications - Frequency Input Module, Cat. Nos. 1794-IJ2, 1794-IJ2K, and 1794-IJ2XT

Input Specifications	
Number of input channels	2
Number of inputs per channel	2 - Frequency and Gate (gate used to establish direction)
Input frequency	Maximum - 1-32 kHz w/sine wave; 1-32 kHz w/square wave input
Frequency value	Maximum 32,767 or 3,276.7 (dependent on range)
Input pulse width	20 μs
Resolution/Accuracy	Refer to Resolution/Accuracy table
On-stage voltage, min	10V (24V IEC+1 proximity, encoder input or switch inputs)
On-state voltage, nom (selected by terminal base connections)	50 mV AC, 28V AC peak - Extended Magnetic Pickup 500 mV AC, 28V AC peak - Magnetic Pickup ≤ 3V - Vortex Flowmeter low range ≥ 6V - Vortex Flowmeter high range 24V DC IEC+1 proximity or encoder input 24V DC Contact Switch input
On-state voltage, max	Limited to isolated 24V DC power supply maximum
On-state current minimum	2.0 mA
On-state current nominal	9.0 mA
On-state current maximum	10.0 mA
Off-state current, min	1.5 mA into 24V DC IEC+ terminal
Off-state voltage, max	5.0V DC on 24V DC IEC+1 terminal
Wire-off detection	0.4 mA for proximity, encoder or contact switch with 50 kΩ shunt resistor
Frequency input impedance	>5 KΩ for 50 mV Extended Magnetic Pickup >5 KΩ for 500 mV Magnetic Pickup >10 KΩ for 3V Vortex Flowmeter low range >10 KΩ for 6V Vortex Flowmeter high range >2.5 KΩ for 24V DC IEC+1 proximity or encoder input >2.5 KΩ for 24V DC Contact Switch input
Gate input impedance	>5 KΩ for 50 mV Extended Magnetic Pickup >5 KΩ for 500 mV Magnetic Pickup >2.5 KΩ for 24V DC IEC+1 proximity or encoder input >2.5 KΩ for 24V DC Contact Switch input
Output Specifications (meets IEC 1A 24V DC output specifications)	
Number of outputs	2 isolated
Output voltage source	Customer supplied
Output voltage minimum	10V DC
Output voltage nominal	24V DC
Output voltage maximum	31.2V DC
Off-state voltage, max	31.2V DC
On-state current	1 mA per output minimum 1.0 A per channel sourced out of module maximum Current Limited - All outputs can be on simultaneously without derating
Surge current	2 A for 50 ms, repeatable every 2 s
Off-state leakage	Less than 300 μA at 31.2V DC maximum

On-state voltage drop	0.9V DC at 1 A
Output control	Outputs individually assignable to: Frequency, % Full Scale or Acceleration Alarm
Output switching time	Triggered by frequency alarm or acceleration alarm Turn on: Less than 0.5 ms Turn off: Less than 1 ms

General

Module location	Cat. No. 1794-TB3G and -TB3GS Terminal Base Units
External DC power Voltage range Supply voltage Supply current	(Input for +5V logic and 24V DC/DC converters) 19.2...31.2V DC (includes 5% AC ripple) 24V DC nominal 220 mA @ 19.2V DC; 180 mA @ 24V DC; 140 mA @ 31.2V DC
Isolated DC power Voltage range Supply voltage Supply current Peak AC ripple	(Output to sensors and encoders) 21.6...26.4V DC 24V DC nominal 0-60 mA maximum @ 24V DC (4 devices @ 15 mA = 60 mA) 100 mV maximum
Dimensions (with module installed in base)	94H x 94W x 69D mm (3.7H x 3.7W x 2.7D in.)
Isolation voltage	50V (continuous), Basic Insulation Type Type tested at 1365V AC for 60 s, between field side and system and individual channels
Processing time	≤4 ms
Flexbus current	30 mA at 5V DC
Power dissipation	4.6W maximum at 31.2V DC
Thermal dissipation	Maximum 15.6 BTU/hr at 31.2V DC
Indicators (field side driven, logic side indication)	1 green/red power/status indicator 4 yellow status indicators (Freq 0, 1, Gate 0, 1) 4 red wire-off indicators (Freq 0, 1, Gate 0, 1) 2 yellow status indicators (Out 0, Out 1) - logic side
Keyswitch Position	1
Wire size	Determined by installed terminal base
Wiring category ¹	2 - on signal ports 3 - on power ports
Wire type	Shielded on signal ports
Terminal screw torque	Determined by installed terminal base
Enclosure type rating	None (open-style)
North American temp code	T4A
IEC temp code	T4

Environmental

Operating temperature	IEC 60068-2-1 (Test Ad, Operating Cold), IEC 60068-2-2 (Test Bd, Operating Dry Heat), IEC 60068-2-14 (Test Nb, Operating Thermal Shock): 0...55 °C (32...131 °F) (1794-IJ2 and 1794-IJ2K) -20...70 °C (-4...158 °F) (1794-IJ2XT)
Non-operating temperature	IEC 60068-2-1 (Test Ab, Unpackaged Non-operating Cold), IEC 60068-2-2 (Test Bb, Unpackaged Non-operating Dry Heat), IEC 60068-2-14 (Test Na, Unpackaged Non-operating Thermal Shock): -40...85 °C (-40...185 °F)
Relative humidity	IEC 60068-2-30 (Test Db, Unpackaged Damp Heat): 5...95% noncondensing
Vibration	IEC 60068-2-6 (Test Fc, Operating): 5 g @ 10...500 Hz
Operating shock	IEC 60068-2-27 (Test Ea, Unpackaged Shock): 30 g
Non-operating shock	IEC 60068-2-27 (Test Ea, Unpackaged Shock): 50 g
Emissions	CISPR 11: Group 1, Class A (with appropriate enclosure)
ESD immunity	IEC 61000-4-2: 4 kV contact discharges (1794-IJ2 and 1794-IJ2K) 6 kV contact discharges (1794-IJ2XT) 8 kV air discharges
Radiated RF immunity	IEC 61000-4-3: 10V/m with 1 kHz sine-wave 80% AM from 80...2000 MHz 10V/m with 200 Hz 50% Pulse 100% AM at 900 MHz 10V/m with 200 Hz 50% Pulse 100% AM at 1890 MHz 3V/m with 1 kHz sine-wave 80% AM from 2000...2700 MHz
EFT/B immunity	IEC 61000-4-4: ±2 kV at 5 kHz on power ports ±2 kV at 5 kHz on shielded signal ports

Surge transient immunity	IEC 61000-4-5: ±2 kV line-earth(CM) on shielded signal ports
Conducted RF immunity	IEC 61000-4-6: 10V rms with 1 kHz sine-wave 80% AM from 150 kHz...80 MHz on shielded signal ports

Certifications

Certifications (when product is marked) ²	Value
c-UL-us	UL Listed Industrial Control Equipment, certified for US and Canada. See UL File E65584. UL Listed for Class I, Division 2 Group A,B,C,D Hazardous Locations, certified for U.S. and Canada. See UL File E194810.
CSA (1794-IJ2 and 1794-IJ2K)	CSA Certified Process Control Equipment. See CSA File LR54689C. CSA Certified Process Control Equipment for Class I, Division 2 Group A,B,C,D Hazardous Locations. See CSA File LR69960C.
CE	European Union 2004/108/EC EMC Directive, compliant with: EN 61326-1; Meas./Control/Lab., Industrial Requirements EN 61000-6-2; Industrial Immunity EN 61000-6-4; Industrial Emissions EN 61131-2; Programmable Controllers (Clause 8, Zone A & B)
C-Tick	Australian Radiocommunications Act, compliant with: AS/NZS CISPR 11; Industrial Emissions
Ex	European Union 94/9/EC ATEX Directive, compliant with: EN 60079-15; Potentially Explosive Atmospheres, Protection "n" (II 3 G Ex nA IIC T4 X) EN 60079-0; General Requirements (Zone 2)
TÜV	TÜV Certified for Functional Safety: up to and including SIL 2

¹ Use this Conductor Category information for planning conductor routing. Refer to Industrial Automation Wiring and Grounding Guidelines, publication [1770-4.1](#).

² See the Product Certification link at <http://www.ab.com> for Declaration of Conformity, Certificates, and other certification details.

www.rockwellautomation.com

Power, Control and Information Solutions Headquarters

Americas: Rockwell Automation, 1201 South Second Street, Milwaukee, WI 53204-2496 USA, Tel: (1) 414.382.2000, Fax: (1) 414.382.4444

Europe/Middle East/Africa: Rockwell Automation, Vorstlaan/Boulevard du Souverain 36, 1170 Brussels, Belgium, Tel: (32) 2 663 0600, Fax: (32) 2 663 0640

Asia Pacific: Rockwell Automation, Level 14, Core F, Cyberport 3, 100 Cyberport Road, Hong Kong, Tel: (852) 2887 4788, Fax: (852) 2508 1846

Publication 1794-IN049D-EN-P - January 2009

Supersedes Publication 1794-IN049C-EN-P - June 2004

PN-38821

Copyright © 2009 Rockwell Automation, Inc. All rights reserved.