

# MP Meter-Pak™ Meter Centers

Catalog  
4141CT0701  
**2008**

## Class 4141

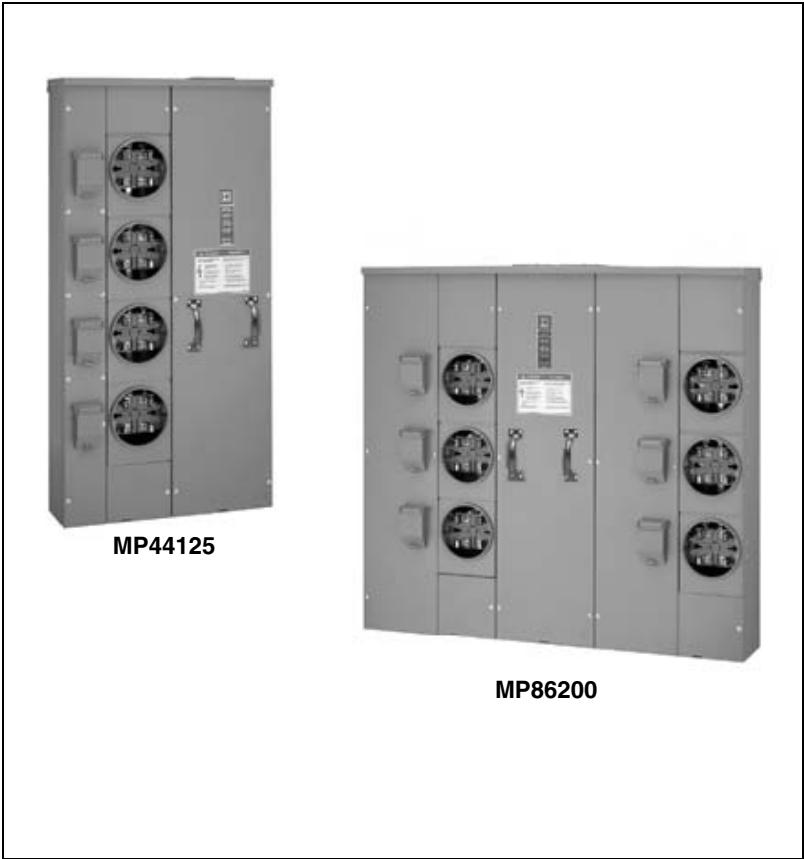

### CONTENTS

Description .....	Page
Product Description .....	2
General and Application Information .....	5
Dimensions .....	22
Wiring Diagrams .....	31



## MP Meter-Pak™ Meter Centers Product Description

### PRODUCT DESCRIPTION



MPH66125 with Horn Bypass



MPH33125

Square D® brand MP Meter-Pak meter centers from Schneider Electric offer a wide range of solutions for multi-metering applications:

- UL® Listed NEMA Type 3R construction
- Meets EUSERC standards
- 9-inch meter center spacing allows for more sockets per device creating lighter, more compact branch enclosures
- Meter socket jaws, constructed of tin-plated copper, are spring reinforced on MP devices
- Lever type bypass meter socket jaws are spring reinforced and equipped with jaw release
- Stainless steel cover hasps and latches meet tough coastal utility sealing requirements
- Barrel lock provisions on all ringless devices

#### MP Meter-Pak Meter Centers

For 2- to 6-unit apartment buildings or light commercial applications.

- Surface and semi-flush mounting
- Suitable only for use as service equipment
- Main bus ratings range from 200–800 A
- 125, 200, and 225 A (2 to 4 positions) tenant circuit breaker versions
- Four meter socket configurations available:
  - Ring type four-jaw without bypass
  - Ringless type with 5th jaw without bypass
  - Ringless type with 5th jaw and horn bypass
  - Ringless type with 5th jaw and lever bypass with jaw release
- 120/240 Vac, 1 $\phi$ 3W or 120/208 Vac, 1 $\phi$ 3W (derived from a 208Y/120 Vac, 3 $\phi$ 4W network)

## Short Circuit Current Rating Selection Process

1. Review local utility requirements to ensure that metering equipment meets their standards.
2. Check with local utility to determine available fault current at the meter center.
3. Use the Short Circuit Current Ratings (SCCR) table below to:
  - a. Read down to select SCCR equal to or greater than desired rating.
  - b. Read across to select Tenant Circuit Breaker type.
4. With information obtained from Step 3, turn to the appropriate selection pages to determine catalog numbers for Meter-Pak Device and Tenant Circuit Breakers.

### UL Listed Meter Center Short Circuit Current Ratings (SCCR) 10,000, 22,000, 25,000, 42,000, 65,000 and 100,000 AIR

Short Circuit Current Rating (RMS Symmetrical Amperes at 240 Vac Maximum) <sup>1</sup>	MP Meter-Pak Meter Centers
	Tenant Circuit Breakers <sup>2</sup>
10,000 AIR <sup>3</sup>	QO (125 A max., 2-pole) QOM2-MM (200 A max., 2-pole) QBP-TM (70–225 A max., 2-pole)
22,000 AIR <sup>3</sup>	QO-VH (125 A max., 2-pole) QOM2-MVH (200 A max., 2-pole)
25,000 AIR <sup>3</sup>	QDP-TM (70–225 A max., 2-pole)
42,000 AIR <sup>3</sup>	QOH (125 A max., 2-pole)
65,000 AIR <sup>3</sup>	QGP-TM (70–225 A max., 2-pole)
100,000 AIR <sup>3</sup>	QJP-TM (70–225 A max., 2-pole)

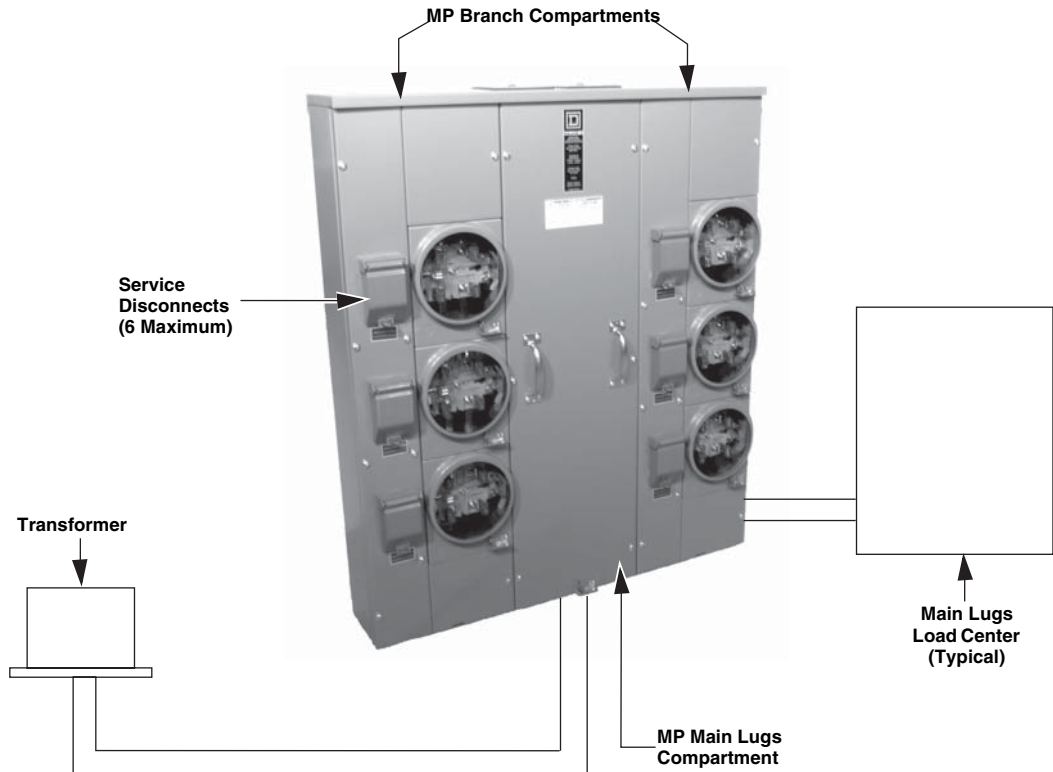

<sup>1</sup> Meter center short circuit current rating is equal to the lowest short circuit current rating given in the table for any circuit breaker installed in any meter panelboard in the meter center.  
<sup>2</sup> When slider type manual circuit closers are installed, the meter center short circuit current rating is limited to 10,000 RMS symmetrical amperes.  
<sup>3</sup> AIR = Amperes Interrupting Rating.

## **Table of Contents**

### **MP METER-PAK™ METER CENTERS**

Application Data . . . . .	5
125 A Maximum MP Meter-Pak Meter Center Configurations . . . . .	6
200 A Maximum MP Meter-Pak Meter Center Configurations . . . . .	6
225 A Maximum MP Meter-Pak Meter Center Configurations . . . . .	6
Type . . . . .	7
Service . . . . .	7
Mains Rating . . . . .	7
Branch Circuit Breaker Provisions . . . . .	7
Meter Sockets . . . . .	7
Meter Socket Covers . . . . .	9
Utility Pull Box Cover . . . . .	11
Customer/Tenant Compartment Cover . . . . .	11
Mounting Channel . . . . .	11
Rotating Mounting Feet . . . . .	11
Top Endwall Configurations . . . . .	12
125 A Maximum MP Meter-Pak Meter Center Top Endwalls . . . . .	12
200 and 225 A Maximum MP Meter-Pak Meter Center Top Endwalls . .	12
Semi-Flush Flange Kits . . . . .	12
MP Meter-Center Hub and Knockout Configurations . . . . .	13
Main Lugs Section Service Conductor Termination Data . . . . .	14
Alternate Lug Kits . . . . .	14
NEMA/EUSERC Lug Landing Kit . . . . .	14–15
Tenant Circuit Breaker Terminal Data . . . . .	16
Service Grounding/Load Neutral and Equipment Grounding Termination Data . . . . .	17
Hinged Rain Channel . . . . .	17
Underground Service Wireway . . . . .	17–18
Catalog Number Description . . . . .	19
Selection . . . . .	20
Dimensions and Knockouts . . . . .	22
Wiring Diagrams . . . . .	31

**Application Data**



**MP22125 (shown)**  
**MPR22125, MPH22125**  
 (Sealing Rings not shown)



**MP55125, MPR55125, MPH55125, MP66125, MPR66125, MPH66125 (shown)**  
 (Top Left Position Omitted on 5-Position Units)



**MP33125, MPR33125, MPH33125 (shown)**



**MP42200 (shown)**  
**MPR42200, MPH42200**



**MP44125 (shown)**  
**MPR44125, MPH44125**



**MP43200, MPR43200**  
**MPH43200 (shown)**

## MP Meter-Pak™ Meter Centers Application Data



MP64200, MPR64200, MPH64200 (shown)



MP85200, MPR85200, MPH85200, MP86200 (shown),  
MPR86200, MPH86200  
(Top Left Position Omitted on 5-Position Units)

### 125 A Maximum MP Meter-Pak™ Meter Center Configurations

- Ring-type MP supplied with 4-jaw meter socket without bypass (5th jaw and manual slider type bypass kits can be ordered separately and field-installed).
- Ringless-type MPR supplied with 5-jaw meter socket without bypass (horn-type bypass kits can be ordered separately and field-installed).
- Ringless-type MPH supplied with 5-jaw meter socket with horn-type bypass.
- Both ring- and ringless-type units have provisions for mounting 2-pole, plug-on type QO®, QO-VH, or QOH circuit breakers.

### 200 A Maximum MP Meter-Pak Meter Center Configurations

- Ring-type MP supplied with 4-jaw meter socket without bypass (5-jaw and manual slider type bypass kits can be ordered separately and field-installed).
- Ringless-type MPR supplied with 5-jaw meter socket without bypass (horn-type bypass kits can be ordered separately and field-installed).
- Ringless-type MPH supplied with 5-jaw meter socket with horn-type bypass.
- Both ring- and ringless-type units have provisions for mounting 2-pole, bolt-on type QOM2-MM or QOM2-MVH circuit breakers.

### 225 A Maximum MP Meter-Pak Meter Center Configurations

- Ringless-type MPL supplied with 5-jaw meter sockets with lever bypass and jaw release.
- MPL devices have provisions for mounting QBP-TM, QDP-TM, QGP-TM, or QJP-TM 2-pole bolt-on type circuit breakers.



MPL32225, MPL53225 (shown), MPL64225

# MP Meter-Pak™ Meter Centers Application Data

## Type



MPH66125

- Enclosures are indoor/rainproof NEMA Type 3R
- MP, MPH and MPR available in 2-, 3-, 4-, 5-, or 6-position configurations
- MPL available in 2-, 3-, or 4-position configurations
- Suitable only for use as service entrance equipment (cannot be fed from an upstream service disconnect)
- Designed to be wall mounted only, not suitable for use as floor standing equipment
- All unmetered conductor compartments are sealable by the utility company
- Finish: ANSI gray, baked powder coat epoxy electro-deposited over cleaned phosphatized steel
- UL Listed under File E-6294

## Service

- 120/240 Vac, 1 $\phi$ 3W
- 120/208 Vac, 1 $\phi$ 3W (derived from a 208Y/120 Vac, 3 $\phi$ 4W network)

## Mains Ratings

### 125 A Maximum MP Meter-Pak Meter Centers

200 A (2-position), 300 A (3-position), 400 A (4-position), 500 A (5-position), and 600 A (6-position) main bus ratings.

### 200 A Maximum MP Meter-Pak Meter Centers

400 A (2- and 3-position), 600 A (4-position) and 800 A (5- and 6-position) main bus ratings.

### 225 A Maximum MP Meter-Pak Meter Centers

350 A (2-position), 500 A (3-position), 600 A (4-position) main bus ratings.



400 A Main Lugs

## Branch Circuit Breaker Provisions

### 125 A Maximum MP Meter-Pak Meter Centers

Accepts 40–125 A, 2-pole, plug-on type QO, QO-VH, or QOH circuit breakers. (Order circuit breakers separately.)

**UL® Listed meter center short circuit current rating (RMS symmetrical amperes) equal to the lowest interrupting rating of installed tenant circuit breaker.**



QO Plug-On  
Mounting Base



QO2100  
Plug-On Circuit  
Breaker Installed

Ampere Rating	10,000 AIR 120/240 Vac	22,000 AIR 120/240 Vac	42,000 AIR 120/240 Vac
40	QO240	QO240VH	QOH240
50	QO250	QO250VH	QOH250
60	QO260	QO260VH	QOH260
70	QO270	QO270VH	QOH270
80	QO280	QO280VH	QOH280
90	QO290	QO290VH	QOH290
100	QO2100	QO2100VH	QOH2100
125	QO2125	QO2125VH	QOH2125

**NOTE:** For load center series ratings used downstream from metering equipment, refer to the following Data Bulletins: 4100DB0301 and 2700DB9901.

# MP Meter-Pak™ Meter Centers

## Application Data



QOM2-MM or QOM2-MVH Bolt-On Mounting Base

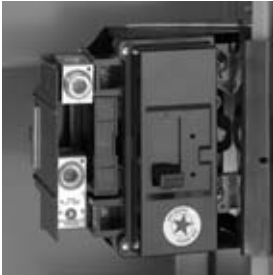

QOM2200MVH Bolt-On Circuit Breaker Installed



QDP22200TM 2-Pole, Bolt-on Type Circuit Breaker



Optional 5th Jaw Kit Installed on Ring-Type Device



Ringless-Type MPH  
Includes 5-Jaw Meter Socket and Horn Bypass

### 200 A Maximum MP Meter-Pak Meter Centers

Accepts 100–200 A, 2-pole, bolt-on type QOM2-MM or QOM2-MVH circuit breakers. (Order circuit breakers separately.)

**UL Listed meter center short circuit current rating (RMS symmetrical amperes) equal to the lowest interrupting rating of tenant circuit breaker installed.**

Ampere Rating	10,000 AIR 120/240 Vac	22,000 AIR 120/240 Vac
100	QOM2100MM	QOM2100MVH
125	QOM2125MM	QOM2125MVH
150	QOM2150MM	QOM2150MVH
175	QOM2175MM	QOM2175MVH
200	QOM2200MM	QOM2200MVH

**NOTE:** For load center series ratings used downstream from metering equipment, refer to Data Bulletins: 4100DB0301 and 2700DB9901.

### 225 A Maximum MP Meter-Pak Meter Centers

Accepts 70–225 A, 2-pole, bolt-on type, QBP-TM, QDP-TM, QGP-TM, or QJP-TM circuit breakers. Also accepts 40–60 A, 2-pole, plug-on type QO, QO-VH or QOH circuit breakers; but requires the use of EZM125QOA adapter kit. (Order circuit breakers and adapter kit separately.)

**UL Listed meter center short circuit current rating (RMS symmetrical amperes) equal to the lowest interrupting rating of tenant circuit breaker installed.**

Ampere Rating	10,000 AIR 120/240 Vac	25,000 AIR 120/240 Vac	65,000 AIR 120/240 Vac	100,000 AIR 120/240 Vac
40	QO240 <sup>1</sup>	QO240VH <sup>1 2</sup>	QOH240 <sup>1 3</sup>	—
50	QO250 <sup>1</sup>	QO250VH <sup>1 2</sup>	QOH250 <sup>1 3</sup>	—
60	QO260 <sup>1</sup>	QO260VH <sup>1 2</sup>	QOH260 <sup>1 3</sup>	—
70	QBP22070TM	QDP22070TM	QGP22070TM	QJP22070TM
80	QBP22080TM	QDP22080TM	QGP22080TM	QJP22080TM
90	QBP22090TM	QDP22090TM	QGP22090TM	QJP22090TM
100	QBP22100TM	QDP22100TM	QGP22100TM	QJP22100TM
110	QBP22110TM	QDP22110TM	QGP22110TM	QJP22110TM
125	QBP22125TM	QDP22125TM	QGP22125TM	QJP22125TM
150	QBP22150TM	QDP22150TM	QGP22150TM	QJP22150TM
175	QBP22175TM	QDP22175TM	QGP22175TM	QJP22175TM
200	QBP22200TM	QDP22200TM	QGP22200TM	QJP22200TM
225	QBP22225TM	QDP22225TM	QGP22225TM	QJP22225TM

<sup>1</sup> Requires use of EZM125QOA adapter (order separately).

<sup>2</sup> QOVH tenant circuit breakers are rated 22,000 AIR at 120/240 Vac.

<sup>3</sup> QOH tenant circuit breakers are rated 42,000 AIR at 120/240 Vac.

### Meter Sockets

#### Standard Meter Socket Configurations

- Rated 200 A continuous duty.
- Front removable spring reinforced jaws equipped with line and load side blade guides.
- Thermoset polyester with fiberglass reinforced base assembly.
- 5th jaw supplied factory-installed on ringless-type MPH and MPR in the 9 o'clock position, 5th jaw can be moved to the 3 or 6 o'clock position as required.
- Ring-type MP supplied with 4-jaw meter socket without bypass.
- Ringless-type MPR supplied with 5-jaw meter socket without bypass.
- Ringless-type MPH supplied with 5-jaw meter socket with horn-type bypass.
- Ringless-type MPL supplied with 5-jaw meter socket with lever bypass and jaw release.



## Optional Meter Socket



Ring-Type MP  
4-Jaw Meter Socket without Bypass

- 5th jaw kit (catalog number 5J) can be field-installed on ring-type MP at the 3, 6, or 9 o'clock position and is required for 120/208 Vac, 1 $\phi$ 3W, service (derived from a 208Y/120 Vac 3 $\phi$ 4W network). One kit required per meter socket, order separately.
- Horn-type bypass kit, catalog number MMHB, can be field-installed on ringless-type MPR. One kit required per meter socket, order separately.
- Manual slider type bypass kit, catalog number MM125MB (for top position only on 125 A, 2-position ring-type MP) or MM200MB (for 125 A and 200 A ring-type MP). One kit required per meter socket, order separately for field-installation.

**NOTE:** Manual slider type bypass kits limit meter center equipment short circuit current rating to 10,000 RMS symmetrical amperes.

## Meter Socket Covers



Manual Slider-Type Bypass, Closed Position  
MM125MB, MM200MB (shown)



Individual Ring-Type  
Meter Socket Cover

### Ring-Type MP Meter Socket Cover

- Individual meter socket cover provided for each meter socket.
- Cover cannot be removed with meter installed in meter socket.
- Seal ring is required to secure base of meter onto rim provided on meter socket cover.
- Aluminum snap-type seal ring (catalog number 29209-100-01) is standard on all ring-type MP meter socket covers.

## Optional Meter Socket Sealing Rings for Type MP

- Stainless steel snap-type sealing ring (catalog number ARP00026). Order separately for field-installation.
- Aluminum screw-type sealing ring (catalog number 29008W). Order separately for field-installation.



Manual Slider-Type Bypass, Open Position  
MM125MB, MM200MB (shown)



Snap-Type Sealing Ring



Screw-Type Sealing Ring

## MP Meter-Pak™ Meter Centers Application Data



Individual Ringless-Type Meter Socket Cover

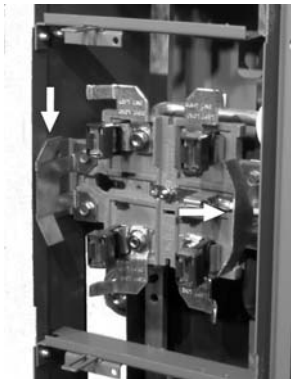

Support Brackets for Base of Meter



Stainless Steel Latch and Hasp,  
Ringless Meter Socket Cover



Barrel Lock Installed Front Entry through Knockout in  
Ringless Meter Socket Cover  
(Reverse View)



Barrel Lock Head Protector Kit MMBLC Installed through  
Knockout in Ringless Meter Socket Cover

### Ringless-Type MPH, MPL, and MPR Meter Socket Covers

- Individual meter socket cover provided for each meter socket.
- Base of meter is supported by brackets extending from meter socket base assembly. Meter socket cover is installed over meter to seal meter base to socket.
- Ringless meter socket covers are each supplied with a stainless steel latch and hasp to accommodate utility seals including lead wire seals, barrel locks, ribbon seals, padlocks, and snap-type seals.
- Ringless meter socket covers are also supplied with a 3/4-inch knockout to accommodate front-entry barrel locks.
- Barrel lock bracket located behind 3/4-inch knockout in each ringless meter socket cover.
- Barrel lock head protector kit (catalog number MMBLC) includes ferrule, lock nut, and seal cap to accommodate 1-inch long barrel lock (barrel lock not included).

**Utility Pull Box Cover**

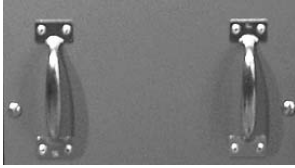

Lifting Handles for Pull Box Cover

- Supplied with handles on 3- through 6-position 125 A maximum, 2- through 6-position 200 A maximum, and 2- through 4-position 225 A maximum Meter-Pak meter center units.
- Supplied with rotating locking hasp to accommodate utility seals including lead wire seals, barrel locks, ribbon seals, padlocks, and snap-type seals.



Hasp with Cover Installed



Rotating Locking Hasp



**Customer/Tenant Compartment Cover**

- Removable without interfering with meter covers.
- Supplied with rotating locking hasp to accommodate a padlock (see rotating locking hasp above).
- Supplied with vertical rainproof tenant circuit breaker covers, one per meter socket.



Tenant Compartment  
Circuit Breaker Cover



Circuit Breaker Cover,  
Closed



Circuit Breaker Cover,  
Open

**Tenant Circuit Breaker Covers**

- Constructed of impact resistant thermoplastic
- Provisions for padlocking or sealing
- Equipped with latch

**Mounting Channel**

- Mounting channel supplied with 3- through 6-position 125 A maximum and all 200 A and 2- through 4-position 225 A maximum units.
- Mounting flange is formed as a part of the top endwall to permit easy installation.
- Mount the channel to the wall at proper height. Hang unit on channel from mounting flange.

**Rotating Mounting Bracket**

- Permanently attached to save time
- Easily moved for mounting hole drilling after marking
- Accommodates slight mounting hole misalignment
- Used for permanent mounting of device to wall



Mounting Channel



Rotating Mounting Bracket

# MP Meter-Pak™ Meter Centers

## Application Data



Closing Plate ACP (supplied)  
2-Position 125 A Top Endwall



Type A Hub Installed  
2-Position 125 A Top Endwall



Closing Plate ACPL (supplied)  
3- and 4-Position 125 A Top Endwall

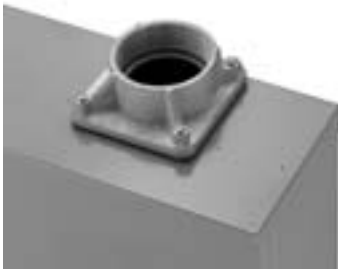

Type A-L Hub Installed  
3- and 4-Position 125 A Top Endwall



Two Closing Plates ACPL (supplied)  
5- and 6-Position 125 A Top Endwall and  
2- through 6-Position 200 A Top Endwall  
2- through 4-Position 225 A Top Endwall



Two Type A-L Hubs Installed  
5- and 6-Position 125 A Top Endwall and  
2- through 6-Position 200 A Top Endwall  
2- through 4-Position 225 A Top Endwall

### Top Endwall Configurations

#### 125 A Maximum MP, MPR, and MPH Meter-Pak Meter Center Top Endwalls

- 2-position unit has utility compartment provisions for mounting one type A hub for use with 1- through 2.5-inch size conduit. Closing plate (Catalog Number ACP) supplied, order hub separately.
- 3- and 4-position units have utility compartment provisions for mounting one type A-L hub for use with 2- through 4-inch size conduit. Closing plate (Catalog Number ACPL) supplied, order hub separately.
- 5- and 6-position units have utility compartment provisions for mounting two type A-L hubs for use with 2- through 4-inch size conduits. Two ACPL closing plates supplied, order hubs separately.

#### 200 and 225 A Maximum MP, MPR, and MPH Meter-Pak Meter Center Top Endwalls

2- through 6-position units have utility compartment provisions for mounting two type A-L hubs for use with 2- through 4-inch size conduit. Two ACPL closing plates supplied, order hubs separately.

#### Semi-Flush Flange Kits

Prior to installation, semi-flush flange kits can be ordered separately for field modification. (Refer to instructions included in kits for complete directions.)

To drill enclosure top endwall and box sides to secure mounting flanges:

1. Drill 5/16-inch diameter clearance holes at center punched marks provided and secure flanges with 1/4-20 mounting hardware provided.
2. Secure mounting flanges of enclosure to stud wall on three sides (top, left, and right).
3. Cover mounting flanges with building paper and caulk to seal between enclosure and building paper.

#### 225 A Maximum MPL Meter-Pak Meter Center Top Endwalls

2- through 4-position units have utility compartment provisions for mounting two type A-L hubs for use with 2- through 4-inch size conduit. Two ACPL closing plates supplied, order hubs separately.

#### Semi-Flush Flange Kit

Description	Catalog Number
125 A Maximum 2-Position	MPSF12
125 A Maximum 3- and 4-Position	MPSF14
125 A Maximum 5- and 6-Position	MPSF16
200 A Maximum 2- and 3-Position	MPSF23
200 A Maximum 4-Position	MPSF24
200 A Maximum 5- and 6-Position	MPSF26



Semi-Flush Flange Kit  
MPSF23

# MP Meter-Pak™ Meter Centers Application Data



## Knockouts

Symbol	Conduit Size		Hole Diameter	
	in.	[mm]	in.	[mm]
A	0.50	13	0.88	22
B	0.75	19	1.25	29
C	1.00	25	1.38	35
D	1.25	32	1.75	44
E	1.50	38	2.00	51
F	2.00	51	2.50	64
G	2.50	64	3.00	76
H	3.00	76	3.63	92
I	3.50	89	4.19	105
J	4.00	102	4.63	117

## MP Meter-Pak Meter Center Hub and Knockout Configurations

Maximum Tenant Circuit Breaker Ampere Rating and Number of Positions	Catalog Number	Top Endwall Pull Box Compartment		Bottom Endwall		Box Back Tenant Circuit Breaker Compartment Knockouts
		Closing Plate(s) Supplied Factory-Installed	Hub Provisions	Pull Box Compartment Knockout and Hub Provisions	Tenant Circuit Breaker Compartment Knockouts	
125 A 2-Position	MP22125 MPH22125 MPR22125	(1) ACP	(1) Type A	(1) Type A Hub or (1) B300 Hub or (1) D, F, G, and (1) A	(2) C, D, F and (1) A	(2) C, D, F <sup>1</sup>
125 A 3-Position	MP33125 MPH33125 MPR33125	(1) ACPL	(1) Type A-L	(2) Type A-L Hubs or (2) E, F, G, H and (1) A, B Note: One knockout is provided with I and J rings.	(4) C, D, F and (1) A, B	(4) C, D, F
125 A 4-Position	MP44125 MPH44125 MPR44125					
125 A 5-Position	MP55125 MPH55125 MPR55125	(2) ACPL	(2) Type A-L	(2) Type A-L Hubs or (2) G, H, I, J and (1) A	(3) C, D, F and (1) A, B Provided per compartment.	(3) C, D, F Provided per compartment.
125 A 6-Position	MP66125 MPH66125 MPR66125					
200 A 2-Position	MP42200 MPH42200 MPR42200	(2) ACPL	(2) Type A-L	(2) Type A-L Hubs or (2) G, H, I, J and (1) A	(4) C, D, F and (1) A, B	(3) C, D, F
200 A 3-Position	MP43200 MPH43200 MPR43200					
200 A 4-Position	MP64200 MPH64200 MPR64200	(2) ACPL	(2) Type A-L	(2) Type A-L Hubs or (2) G, H, I, J and (1) A	(4) C, D, F and (1) A, B	(4) C, D, F
200 A 5-Position	MP85200 MPH85200 MPR85200					
200 A 6-Position	MP86200 MPH86200 MPR86200	(2) ACPL	(2) Type A-L	(2) Type A-L Hubs or (2) G, H, I, J and (1) A, B, C	(3) C, D, F and (1) A, B Provided per compartment.	(3) C, D, F Provided per compartment.
225 A 2-Position	MPL32225	(2) ACPL	(2) Type A-L	(2) Type A-L Hubs or (2) E, F, G, H, I, J and (1) A, B	(3) C, D, E, F and (1) A, B	(3) C, D, E, F
225 A 3-Position	MPL53225	(2) ACPL	(2) Type A-L	(2) Type A-L Hubs or (2) E, F, G, H, I, J and (1) A, B	(4) C, D, E, F and (1) A, B	(4) C, D, E, F
225 A 4-Position	MPL64225	(2) ACPL	(2) Type A-L	(2) Type A-L Hubs or (2) E, F, G, H, I, J and (1) A, B	(5) C, D, E, F and (1) A, B	(5) C, D, E, F

<sup>1</sup> Same knockout pattern on side of box.

# MP Meter-Pak™ Meter Centers

## Application Data



Main Lugs Compartment



MMLK250



MMLK500



MMSK2



MMLK600



MMSK4

## Main Lugs Section

### Service Conductor Termination Data

- Neutral bus is bonded permanently to the enclosure
- Suitable only for use as service equipment

#### 125 A Maximum MP Meter-Pak™ Meter Center Service Conductor Termination Data

Number of Meter Socket Positions	Main Bus Rating (Amperes)	Factory-Installed Main Lugs Capacity (Amperes)	Line Phase and Neutral Lug Wire Size Al/Cu AWG kcmil
2	200 A	200 A	(1) #4-250
3	300 A	300 A	(1) 1/0-600 or (2) 1/0-250
4	400 A	400 A	
5	500 A	400 A Al or 500 A Cu	
6	600 A	400 A Al or 500 A Cu	

#### 200 A Maximum MP Meter-Pak Meter Center Service Conductor Termination Data

2	400 A	400 A	(1) 1/0-600 or (2) 1/0-250
3	400 A	400 A	
4	600 A	400 A Al or 500 A Cu	
5	800 A	600 A Al or 750 A Cu	(2) 3/0-500
6	800 A	600 A Al or 750 A Cu	

#### 225 A Maximum MP Meter-Pak Meter Center Service Conductor Termination Data

2	350 A	350 A	(1) 1/0-600 or (2) 1/0-250
3	500 A	400 A	
4	600 A	400 A	

### Alternate Lug Kits

Available for use on 3–6 position 125 A, all 200 A, and all 225 A Meter-Pak meter center units (order separately):

Catalog Number	Lug Type (Mechanical)	Lug Wire Size Al/Cu AWG/kcmil
MMLK250 <sup>1</sup>	Double-Barrel	(1) 1/0-600 or (2) 1/0-250
MMLK500	Double-Barrel	(2) 3/0-500
MMLK600 <sup>2</sup>	Double-Barrel	(2) #2-600

<sup>1</sup> Standard lug kit supplied factory-installed on 3–6 position 125 A units, 2–4 position 200 A units, and 2–4 position 225 A units.

<sup>2</sup> Kit includes NEMA/EUSERC lug landing pads (MMSK2). Kit is rated 800 A maximum (600 A maximum in EUSERC areas).

### NEMA/EUSERC Lug Landing Kit

- Catalog numbers MMSK2 and MMSK4 (order separately).
- MMSK2 is available for use on 3- through 6-position 125 A and all 200 A Meter-Pak meter center units.
- MMSK4 is available for use ONLY on MPL53225 and MPL64225, Not required for MPL32225.
- Kits include three bus bar lug landing pads and mounting hardware to secure pads to main cross bus.
- Each lug landing pad with MMSK2 is supplied with two 1/2-13 studs; MMSK4 with four 1/2-13 studs; all on 1-3/4 inch center. Kits include lug mounting hardware.
- MMSK2 is rated 600A maximum when applied in EUSERC areas.
- Order one kit per Meter-Pak device, order lugs separately (refer to each device wiring diagram for lug catalog numbers).

Lugs for Use with NEMA/EUSERC Lug Landing Kit MMSK2



MMSK2

Mains Rating	Lug Manufacturer	Catalog Number <sup>1</sup>	Lug Type	Lug Wire Size AWG/kcmil	Crimping Tool or Torque
300 A	Anderson	VACL-500-12BN	Compression	4/0-500 Al/Cu	VC-6FT
		VCEL-060-12H2		400-600 Al, 400-500 Cu	VC-6FT
		VCEL-075-12H2		500 Cu	VC-6FT
		VHCL-500-12BN		4/0-500 Cu	VC-6FT
		VHCL-400-12BN		4/0-400 Cu	VC-6FT
		VHCL-350-12BN		3/0-350 Cu	VC-6FT
	ILSCO	TA-600-2N <sup>2</sup>	Mechanical	#2-600 Al/Cu	375 lb-in. (42 N•m)
	AU-600-2N		(2) #2-600 Al/Cu	500 lb-in. (57 N•m)	
400 A	Anderson	VHCL-600-12BN	Compression	250-600 Cu	VC-6FT
	ILSCO	TA-600-2N <sup>2</sup>	Mechanical	#2-600 Al/Cu	375 lb-in. (42 N•m)
AU-600-2N		(2) #2-600 Al/Cu		500 lb-in. (57 N•m)	
500-600 A	ILSCO	AU-600-2N	Mechanical	(2) #2-600 Al/Cu	500 lb-in. (57 N•m)
800 A		AU-600-2N		(2) 3/0-500 Al/Cu	500 lb-in. (57 N•m)

<sup>1</sup> Lugs are not available from Schneider Electric and must be ordered separately from Anderson or ILSCO.

<sup>2</sup> Available by ordering kit catalog number CMEK4 (kit includes 4 lugs).

Lugs for Use with NEMA Lug Landing Kit MMSK4



MMSK4

Catalog Number	Lug Manufacturer	Catalog Number <sup>1</sup>	Lug Type	Lug Wire Size AWG/kcmil	Crimping Tool or Torque	
MPL32225 <sup>2</sup>	Anderson	L1D2-600	Mechanical	#2-600 Al/Cu	550 lb-in. (62 N•m)	
		L1D2-800		300-800 Al/Cu	550 lb-in. (62 N•m)	
		VCEL-050-12H2	Compression	2/0-500 Al/Cu	VC-6FT	
		VCEL-060-12H2		400-600 Al or 400-500 Cu	VC-6FT	
		VCEL-075-12H2		500-750 Al or 500 Cu	VC-6FT	
		VACL-500-12BN		4/0-500 Al/Cu	VC-6FT	
		VACL-600-12BN		350-600 Al or 350-500 Cu	VC-6FT or VC8	
		VACL-750-12BN		500-750 Al or 500 Cu	VC-6FT or VC8	
		VACL-1000-12BN		750-1000 Al	VC8	
		VHCL-500-12BN		4/0-500 Cu	VC-6FT or VC-7FT	
	VHCL-600-12BN	3/0-350 Cu	VC-6FT			
	ILSCO	TA-600-2N <sup>3</sup>	Mechanical	#2-600 Al/Cu	375 lb-in. (42 N•m)	
		TA-800-2N		300-800 Al/Cu	500 lb-in. (57 N•m)	
		AU-600-2N		(2) #2-600 Al/Cu	500 lb-in. (57 N•m)	
		Connector Manufacturing Company	A1B2-600-2	Mechanical	#2-600 Al/Cu	375 lb-in. (42 N•m)
			2AB2-600		(2) #2-600 Al/Cu	375 lb-in. (42 N•m)
	3AB2-250		(3) #6-250 Al/Cu		275 lb-in. (31 N•m)	
	L1D2-800		300-800 Al/Cu		550 lb-in. (62 N•m)	
MPL53225	Anderson	L1D2-600	Mechanical	#2-600 Al/Cu	550 lb-in. (62 N•m)	
		VCEL-050-12H2	Compression	2/0-500 Al/Cu	VC-6FT	
		VCEL-060-12H2		400-600 Al, 400-500 Cu	VC-6FT	
		VACL-500-12BN		4/0-500 Al/Cu	VC-6FT	
		VHCL-500-12BN		4/0-500 Cu	VC-6FT or VC-7FT	
	VHCL-600-12BN	250-600 Cu		VC-6FT, VC-7FT, or VC-8		
	ILSCO	TA-600-2N <sup>3</sup>	Mechanical	#2-600 Al/Cu	375 lb-in. (42 N•m)	
	Connector Manufacturing Company	A1B2-600-2	Mechanical	#2-600 Al/Cu	375 lb-in. (42 N•m)	
3AB2-250		(3) #6-250 Al/Cu		275 lb-in. (31 N•m)		

<sup>1</sup> Lugs are not available from Schneider Electric and must be ordered separately from Anderson or ILSCO.

<sup>2</sup> Lug landing kit is not required for this device.

<sup>3</sup> Available by ordering kit catalog number CMEK4 (kit includes 4 lugs).

Continued on next page

# MP Meter-Pak™ Meter Centers

## Application Data

### Lugs for Use with NEMA Lug Landing Kit MMSK4

Continued from previous page



MMSK4

Catalog Number	Lug Manufacturer	Catalog Number <sup>1</sup>	Lug Type	Lug Wire Size AWG/kcmil	Crimping Tool or Torque
MPL64225	Anderson	L1D2-600	Mechanical	#2-600 Al/Cu	550 lb-in. (62 N•m)
		L1D2-800		300–800 Al/Cu	550 lb-in. (62 N•m)
		VCEL-050-12H2	Compression	2/0–500 Al/Cu	VC-6FT
		VCEL-060-12H2		400–600 Al or 400–500 Cu	VC-6FT
		VCEL-075-12H2		500–750 Al or 500 Cu	VC-6FT
		VACL-500-12BN		4/0–500 Al/Cu	VC-6FT
		VACL-600-12BN		350–600 Al or 350–500 Cu	VC6-FT or VC8
		VACL-750-12BN		500–750 Al or 500 Cu	VC6-FT or VC8
		VHCL-500-12BN		4/0–500 Cu	VC6-FT or VC7-FT
	VHCL-600-12BN	250–600 Cu	VC6-FT, VC7-FT or VC8		
	ILSCO	TA-600-2N <sup>3</sup>	Mechanical	#2-600 Al/Cu	375 lb-in. (42 N•m)
		TA-800-2N		300–800 Al/Cu	500 lb-in. (57 N•m)
		AU-600-2N		(2) #2-600 Al/Cu	500 lb-in. (57 N•m)
	Connector Manufacturing Company	A1B2-600-2	Mechanical	#2-600 Al/Cu	375 lb-in. (42 N•m)
		2AB2-600		(2) #2-600 Al/Cu	375 lb-in. (42 N•m)
		3AB2-250		(3) #6-250 Al/Cu	275 lb-in. (31 N•m)
L1D2-800		300–800 Al/Cu		550 lb-in. (62 N•m)	

<sup>1</sup> Lugs are not available from Schneider Electric and must be ordered separately from Anderson or ILSCO.

<sup>2</sup> Lug landing kit is not required for this device.

<sup>3</sup> Available by ordering kit catalog number CMELK4 (kit includes 4 lugs).

## Tenant Circuit Breaker Termination Data

### 125 A Maximum MP Meter-Pak Meter Center Tenant Circuit Breaker Termination Data

Tenant Circuit Breaker	
Type and Ampere Rating	Lug Wire Size
QO, QO-VH, and QOH 2-pole, 40–70 A	#8–#2 AWG Al/Cu
QO, QO-VH, and QOH 2-pole, 80–125 A	#4–2/0 AWG Al/Cu

### 200 A Maximum MP Meter-Pak Meter Center Tenant Circuit Breaker Termination Data

Tenant Circuit Breaker		
Type and Ampere Rating	Lug Wire Size	Wire Bending Space
QOM2-MM and QOM2-MVH 2-pole, 100–200 A	#4 AWG–300 kcmil Al/Cu	#4 AWG–250 kcmil Al/Cu <sup>1</sup>

<sup>1</sup> Bottom tenant circuit breaker position has wire bending space to accommodate 300 kcmil wire, for bottom feed only.

### 225 A Maximum MP Meter-Pak Meter Center Tenant Circuit Breaker Termination Data

Tenant Circuit Breaker		
Type and Ampere Rating	Lug Wire Size	Wire Bending Space
QBP-TM, QDP-TM, QGP-TM, and QJP-TM, 2-pole, 70–225 A	#4 AWG–300 kcmil Al/Cu	#4 AWG–300 kcmil Al/Cu



## **Service Grounding/Load Neutral and Equipment Grounding Termination Data**



**Equipment Grounding Lugs**



**Service Grounds and Load Neutrals**

- Service grounding/load neutral lugs, located in the tenant compartment, are bonded to the enclosure.
- Two service grounding lugs provided per device.
- One load neutral lug and one equipment grounding lug are provided for each tenant circuit breaker position.

### **125 A Maximum MP, MPH, and MPR Meter-Pak Meter Centers**

Load neutral and service grounding lugs will accept one #14-2/0 AWG Cu or one #12-2/0 AWG Al conductor.

### **200 A Maximum MP, MPH, and MPR Meter-Pak Meter Centers**

Load neutral and service grounding lugs will accept one #6 AWG–300 kcmil Al/Cu conductor.

### **225 A Maximum MP, MPH, and MPR Meter-Pak Meter Centers**

Load neutral and service grounding lugs will accept one #4 AWG–300 kcmil Al/Cu conductor.



**Hinged Rain Channel**

## **Hinged Rain Channel**

Rain channel is hinged at bottom of tenant compartment allowing easy access to wiring gutter for pulling wires.

## **Underground Service Wireway**

Square D brand Underground Service Wireways are a convenient solution for protecting a utility's underground service conductors that terminate in MP Meter-Pak Meter Centers.

These Underground Service Wireways are not load-bearing; they are intended for use only as a means to cover and secure service entrance cables prior to entering a wall-mounted Square D MP Meter-Pak device. The units connect easily to any MP Meter-Pak Meter Center by attaching to tapped hub provisions in the bottom endwall of the metering device.

- Cover latch accommodates up to three different types of utility seals.
- All locking provisions are made of durable, corrosion-resistant stainless steel for long-lasting security.
- Mounts easily to MP Meter-Pak device's underground, bolt-on hub provisions using supplied hardware.
- Open bottom with ½ inch srolled edge reduces possibility of cutting conductor insulation.
- Wireway covers are secured by latching means (no screws to lose).
- Gasketed, bushed openings in top provide watertight seal between the wireway and MP Meter-Pak device.
- Constructed of 14-gauge painted galvalume steel for superior corrosion protection in all applications.



**MP43X11PED Shown with Cover Off (left) and On (above)**

# MP Meter-Pak™ Meter Centers

## Application Data

### Underground Service Wireway Devices

Catalog Number	Description	Height		Width	
		in.	mm	in.	mm
MP43X11PED	Underground Service Wireway	43	1092	11	279
MP43X8PED	Underground Service Wireway	43	1092	8	203
MP35X11PED	Underground Service Wireway	35	889	11	279
MP12X11PEDEXT	Underground Service Wireway One-foot Extension	12	305	11	279
MP12X8PEDEXT	Underground Service Wireway One-foot Extension	12	305	8	203

### Selection Chart

Wireway Catalog Number	Grade to Device Bottom	Grade to Meter				MP Meter-Pak Device				
		Bottom Meter		Top Meter						
		in.	mm	in.	mm					
MP43X8PED	25 in. [635 mm]	42.5	1080	51.5	1308	MP22125				
						MPR22125				
						MPH22125				
MP43X11PED	25 in. [635 mm]	36.0	914	54.0	1372	MP33125				
						MPR33125				
						MPH33125				
						MP44125				
						MPR44125				
				MPH44125						
				54.0	1372	MP55125				
						MPR55125				
						MPH55125				
						MP66125				
		MPR66125								
		37.25	946	54.0	1372	1372	1372	MPH66125		
								MP42200		
								MPR42200		
								MPH42200		
								MP43200		
				55.25	1403	1403	1403	1403	1403	MPR43200
										MPH43200
										MP64200
										MPR64200
MPH64200										
55.25	1403	1403	1403	1403	1403	MP85200				
						MPR85200				
						MPH85200				
						MP86200				
						MPR86200				
						MPH86200				
MP35X11PED	16.625 in. [422 mm]	50.625	1286	64.625	1642	MPL32225				
MP43X11PED	25 in. [635 mm]	38.375	975	66.375	1686	MPL43225				
MP35X11PED	16.625 in. [422 mm]	30.0	762	72.0	1829	MPL64225				

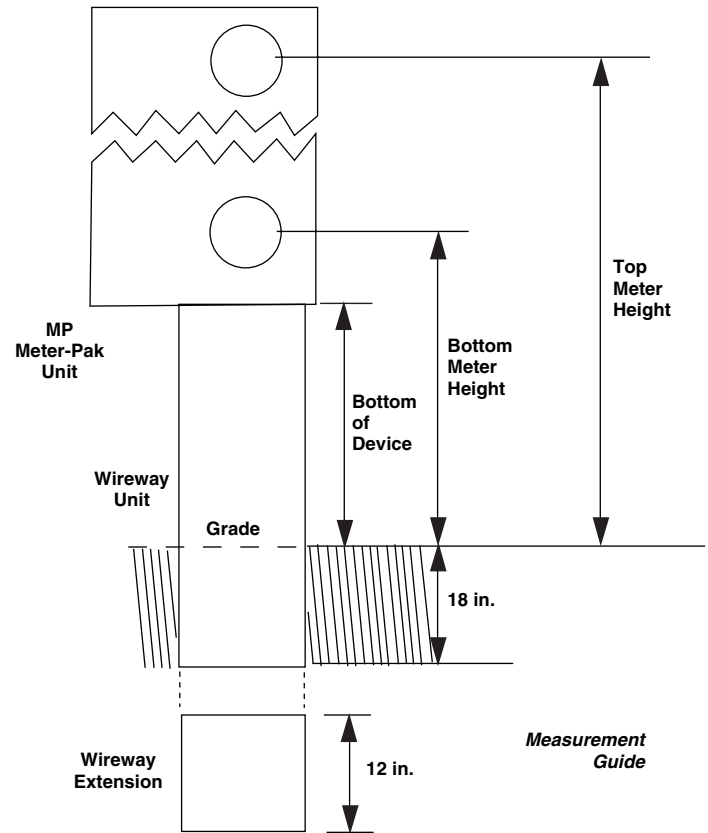

### Underground Service Wireway One-Foot Extension Selection Guide\*

For applications requiring additional depth, or for sloped grades, the one-foot extension can be installed to the bottom of the underground service wireway with supplied hardware.

Wireway Extension Catalog Number	Wireway Catalog Number
MP12X11PEDEXT	MP43X11PED
MP12X8PEDEXT	MP35X11PED
MP12X8PEDEXT	MP43X8PED

\*Selection based on Underground Service Wireway catalog numbers.

## Catalog Number Description

<b>Number Segment</b>	<b>Character</b>	<b>Description</b>	<b>MP</b>	<b>H</b>	<b>4</b>	<b>4</b>	<b>125</b>
Device Name	MP	Meter-Pak Meter Center					
Socket/Bypass Type	Blank	Ring Type					
	R	Ringless with 5th Jaw					
	H	Ringless with Horn Bypass and 5th Jaw					
	L	Ringless with Lever Bypass, Jaw Release and 5th Jaw					
Bus Ampacity	2	200 A					
	3	300 A					
	4	400 A					
	5	500 A					
	6	600 A					
	8	800 A					
Number of Meter Sockets	2	2-Positions MP, MPH, MPL, and MPR					
	3	3-Positions MP, MPH, MPL, and MPR					
	4	4-Positions MP, MPH, MPL, and MPR					
	5	5-Positions MP, MPH, and MPR					
	6	6-Positions MP, MPH, MPL, and MPR					
Max. Tenant Circuit Breaker Amperage	125	125 A					
	200	200 A					
	225	225 A					

# MP Meter-Pak™ Meter Centers

Select MP Meter-Pak meter center short circuit current rating RMS symmetrical amperes from table on page 3, then make selections from the following:

Step 1: Select Ring or Ringless Type MP Meter-Pak™ Meter Centers	Ampere Rating	Number of Positions	Metering Equipment			
			Ring-Type, 4-Jaw Catalog Number	Ringless Type, 5-Jaw		
				No Bypass Catalog Number	Horn Bypass Catalog Number	Lever Bypass Catalog Number
125 A (Use QO® Circuit Breakers)	2	MP22125	MPR22125	MPH22125	—	
	3	MP33125 <sup>1</sup>	MPR33125	MPH33125	—	
	4	MP44125 <sup>1</sup>	MPR44125	MPH44125	—	
	5	MP55125 <sup>1</sup>	MPR55125	MPH55125	—	
	6	MP66125 <sup>1</sup>	MPR66125	MPH66125	—	
200 A (Use QOM2 Circuit Breakers)	2	MP42200 <sup>1</sup>	MPR42200	MPH42200	—	
	3	MP43200 <sup>1</sup>	MPR43200	MPH43200	—	
	4	MP64200 <sup>1</sup>	MPR64200	MPH64200	—	
	5	MP85200 <sup>1</sup>	MPR85200	MPH85200	—	
	6	MP86200 <sup>1</sup>	MPR86200	MPH86200	—	
225 A (Use QB, QD, QG or QJ Circuit Breakers)	2	—	—	—	MPL32225	
	3	—	—	—	MPL53225	
	4	—	—	—	MPL64225	

<sup>1</sup> Meets EUSERC standards with addition of lug landing kit, MMSK2.

Step 2: Select Tenant Circuit Breakers	Device Type	Ampere Rating	10,000 AIR 120/240 Vac	22,000 AIR 120/240 Vac	25,000 AIR 120/240 Vac	42,000 AIR 120/240 Vac	65,000 AIR 120/240 Vac	100,000 AIR 120/240 Vac
125 A	40	QO240	QO240VH	—	QOH240	—	—	
	50	QO250	QO250VH	—	QOH250	—	—	
	60	QO260	QO260VH	—	QOH260	—	—	
	70	QO270	QO270VH	—	QOH270	—	—	
	80	QO280	QO280VH	—	QOH280	—	—	
	90	QO290	QO290VH	—	QOH290	—	—	
	100	QO2100	QO2100VH	—	QOH2100	—	—	
	125	QO2125	QO2125VH	—	QOH2125	—	—	
200 A	100	QOM2100MM	QOM2100MVH	—	—	—	—	
	125	QOM2125MM	QOM2125MVH	—	—	—	—	
	150	QOM2150MM	QOM2150MVH	—	—	—	—	
	175	QOM2175MM	QOM2175MVH	—	—	—	—	
	200	QOM2200MM	QOM2200MVH	—	—	—	—	
225 A	40	QO240 <sup>2</sup>	QO240VH <sup>2</sup>	—	QOH240 <sup>2</sup>	—	—	
	50	QO250 <sup>2</sup>	QO250VH <sup>2</sup>	—	QOH250 <sup>3</sup>	—	—	
	60	QO260 <sup>2</sup>	QO260VH <sup>2</sup>	—	QOH260 <sup>3</sup>	—	—	
	70	QBP22070TM	—	QDP22070TM	—	QGP22070TM	QJP22070TM	
	80	QBP22080TM	—	QDP22080TM	—	QGP22080TM	QJP22080TM	
	90	QBP22090TM	—	QDP22090TM	—	QGP22090TM	QJP22090TM	
	100	QBP22100TM	—	QDP22100TM	—	QGP22100TM	QJP22100TM	
	110	QBP22110TM	—	QDP22110TM	—	QGP22110TM	QJP22110TM	
	125	QBP22125TM	—	QDP22125TM	—	QGP22125TM	QJP22125TM	
	150	QBP22150TM	—	QDP22150TM	—	QGP22150TM	QJP22150TM	
	175	QBP22175TM	—	QDP22175TM	—	QGP22175TM	QJP22175TM	
	200	QBP22200TM	—	QDP22200TM	—	QGP22200TM	QJP22200TM	
	225	QBP22225TM	—	QDP22225TM	—	QGP22225TM	QJP22225TM	

<sup>2</sup> Requires use of EZM125QOA adapter (order separately).

<sup>3</sup> Order only. Not stocked in PDS.

## MP Meter-Pak™ Meter Centers Product Selection

Step 3: Choose Accessories and / or Replacement Parts	Accessories—Description	Catalog Number
	5th Jaw Kit (one per kit)	5J
	Barrel Lock Head Protector Kit (use on MPH, MPL and MPR only; barrel lock not included)	MMBLC
	QO Adapter for Bolt-on QB, QD, QG and QJ Tenant Circuit Breakers (40–125 A, 2-pole)	EZM125QOA
	Horn Bypass Kit (use on MPR and MPH only)	MMHB
	<b>Manual Slider Type Bypass:</b>	
	125 A Ring Type 2-Position Top Meter (only)	MM125MB <sup>1</sup>
	125 A and 200 A Ring Type	MM200MB <sup>1</sup>
	<b>Sealing Rings:</b>	
	Snap-type Aluminum (standard)	29209-100-01
	Screw-type Aluminum	29008W
	Snap-type Stainless Steel	ARP00026
	LEXAN® Meter Socket Closing Plate	29007
	<b>Optional Lug Kits (3 Lugs per kit):</b>	
	(1) 1/0-600 AWG/kcmil or (2) 1/0-250 per phase Al/Cu	MMLK250 <sup>2 3</sup>
	(2) 3/0-500 AWG/kcmil per phase Al/Cu	MMLK500 <sup>3</sup>
	(2) 2-600 AWG/kcmil per phase Al/Cu	MMLK600 <sup>3</sup>
	<b>Semi-flush Kits:</b>	
	125 A, 2-Position	MPSF12
	125 A, 3- and 4-Position	MPSF14
	125 A, 5- and 6-Position	MPSF16
	200 A, 2- and 3-Position	MPSF23
	200 A, 4-Position	MPSF24
	200 A, 5- and 6-Position	MPSF26
	NEMA/EUSERC Lug Landing Kit: For 3- through 6-position 125 A and all 200 A devices. Each pad rated 600 A maximum and includes (2) 1/2-13 studs and mounting hardware.	MMSK2 <sup>3</sup>
	NEMA Lug Landing Kit: For use ONLY on MPL32225, MPL53225 and MPL64225 with optional lugs (see Table on page 16 for lugs)	MMSK4

<sup>1</sup> The meter center short circuit current rating is 10,000 RMS symmetrical amperes when manual slider-type bypass is used. Not rated for continuous duty.

<sup>2</sup> Standard lug for 3- through 6-position 125 A and 2- through 4-position 200 A devices.

<sup>3</sup> Cannot be installed on 2-position 125 A devices.

# MP Meter-Pak™ Meter Centers

## Dimensions

Supplied with ACP Closing Plate  
(for Underground Service).  
Order Type A Hub Separately  
(for Overhead Service).

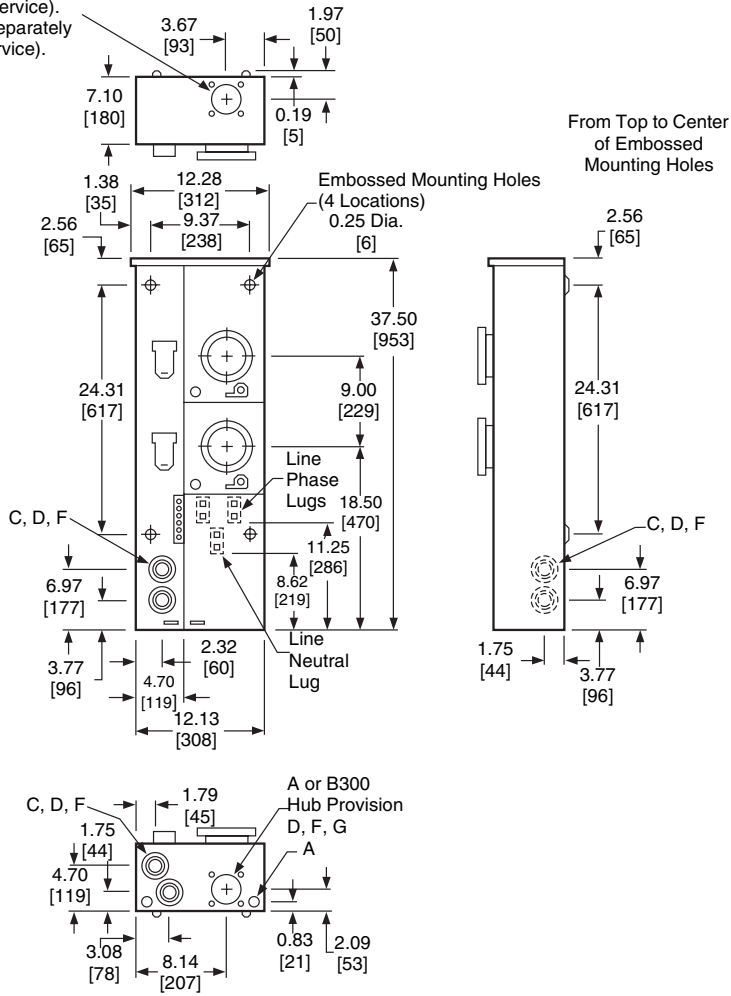

MP22125  
MPR22125  
MPH22125

Knockouts				
Symbol	Conduit Size		Hole Diameter	
	in.	mm	in.	mm
A	0.50	13	0.88	22
B	0.75	19	1.25	32
C	1.00	25	1.38	35
D	1.25	32	1.75	44
E	1.50	38	2.00	51
F	2.00	51	2.50	64
G	2.50	64	3.00	76
H	3.00	76	3.63	92
I	3.50	89	4.13	105
J	4.00	102	4.63	118

Dimensions: in. [mm]

# MP Meter-Pak™ Meter Centers Product Selection

Supplied with ACPL Closing Plate  
(for Underground Service).  
Order Type A-L Hub Separately  
(for Overhead Service).

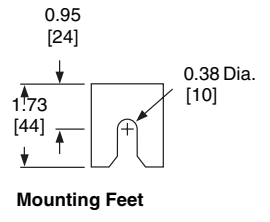
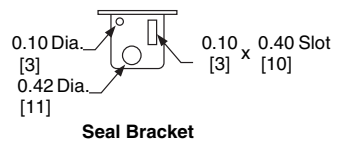
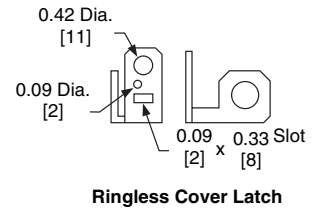
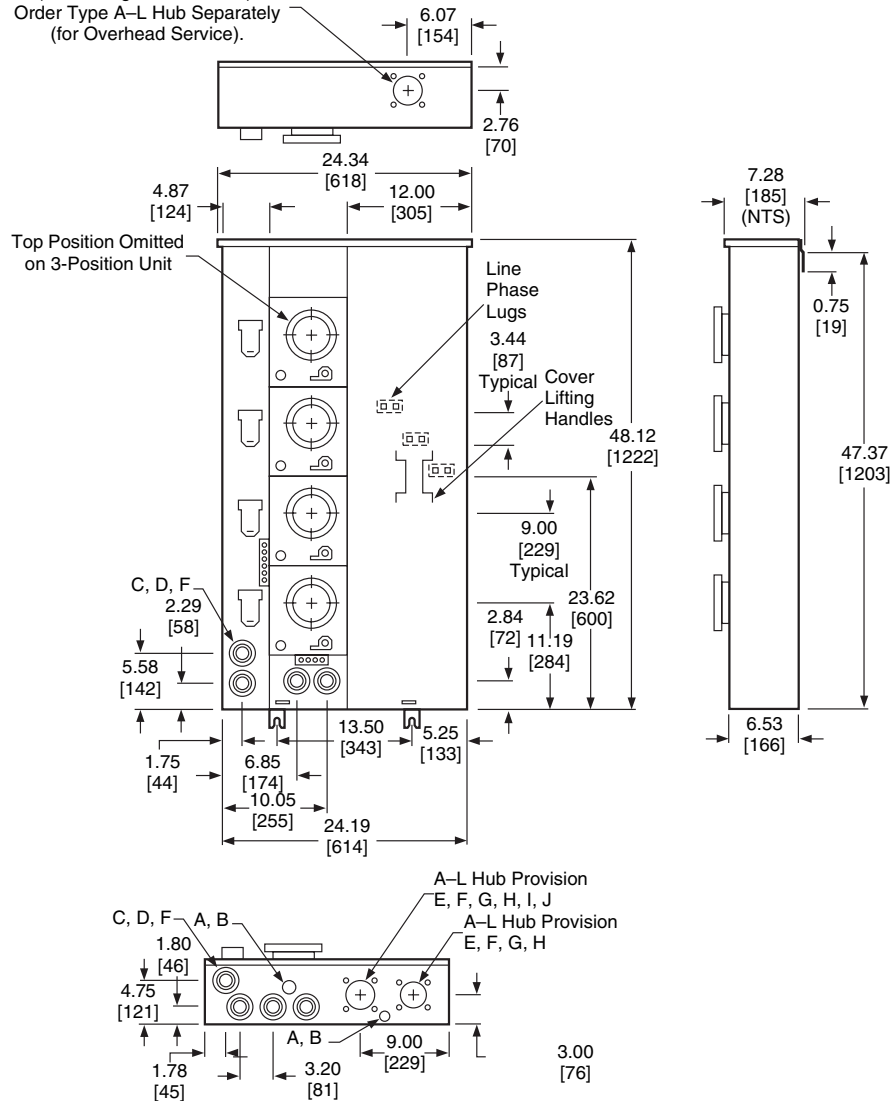

MP33125 MP44125  
MPR33125 MPR44125  
MPH33125 MPH44125

Dimensions: in. [mm]

Knockouts				
Symbol	Conduit Size		Hole Diameter	
	in.	mm	in.	mm
A	0.50	13	0.88	22
B	0.75	19	1.25	32
C	1.00	25	1.38	35
D	1.25	32	1.75	44
E	1.50	38	2.00	51
F	2.00	51	2.50	64
G	2.50	64	3.00	76
H	3.00	76	3.63	92
I	3.50	89	4.13	105
J	4.00	102	4.63	118

# MP Meter-Pak™ Meter Centers

## Product Selection

Supplied with ACPL Closing Plate (for Underground Service).  
Order Type A Hub Separately (for Overhead Service).

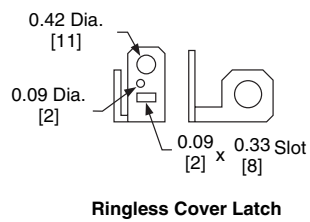
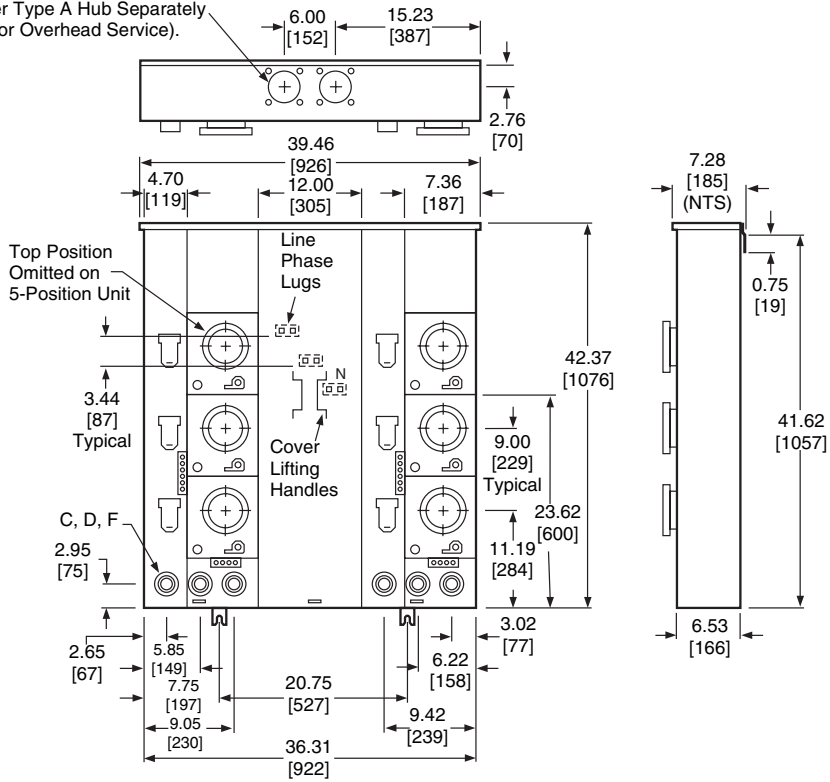

**Ringless Cover Latch**

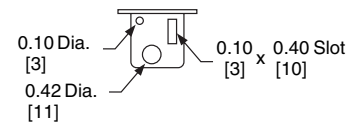

**Seal Bracket**

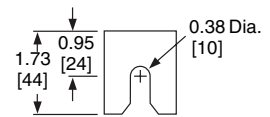

**Mounting Feet**

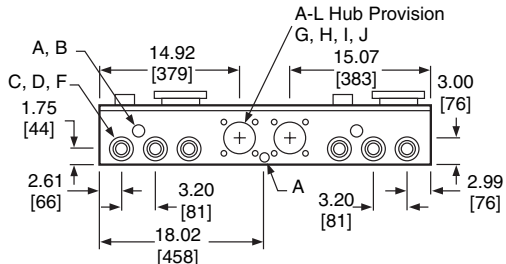

- MP55125    MP66125
- MPR55125    MPR66125
- MPH55125    MPH66125

Knockouts				
Symbol	Conduit Size		Hole Diameter	
	in.	mm	in.	mm
A	0.50	13	0.88	22
B	0.75	19	1.25	32
C	1.00	25	1.38	35
D	1.25	32	1.75	44
E	1.50	38	2.00	51
F	2.00	51	2.50	64
G	2.50	64	3.00	76
H	3.00	76	3.63	92
I	3.50	89	4.13	105
J	4.00	102	4.63	118

Dimensions: in. [mm]



# MP Meter-Pak™ Meter Centers Product Selection

Supplied with ACPL Closing Plate (for Underground Service).  
Order Type A Hub Separately (for Overhead Service).

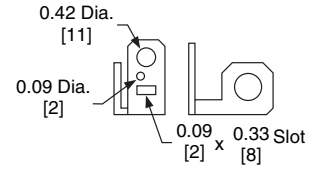
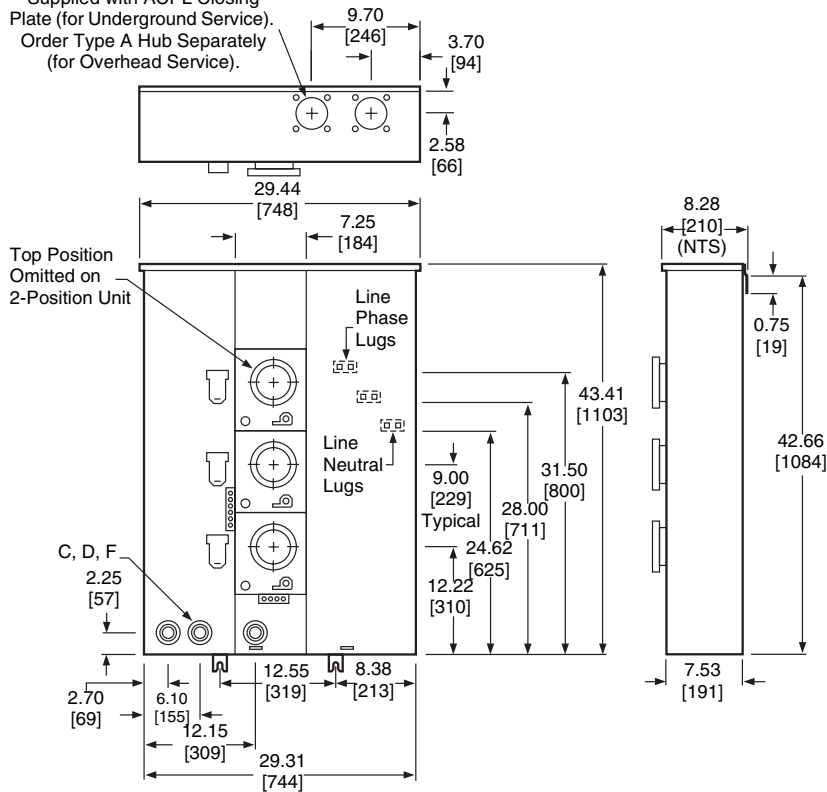

Ringless Cover Latch

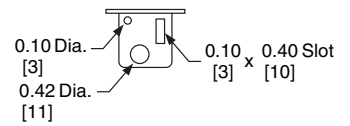

Seal Bracket

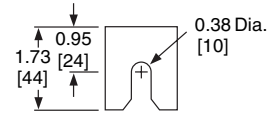

Mounting Feet

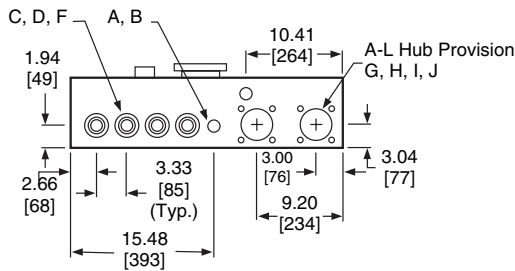

MP42200 MP43200  
MPR42200 MPR43200  
MPH42200 MPH43200

Knockouts				
Symbol	Conduit Size		Hole Diameter	
	in.	mm	in.	mm
A	0.50	13	0.88	22
B	0.75	19	1.25	32
C	1.00	25	1.38	35
D	1.25	32	1.75	44
E	1.50	38	2.00	51
F	2.00	51	2.50	64
G	2.50	64	3.00	76
H	3.00	76	3.63	92
I	3.50	89	4.13	105
J	4.00	102	4.63	118

Dimensions: in. [mm]

# MP Meter-Pak™ Meter Centers

## Product Selection

Supplied with ACPL Closing Plate (for Underground Service).  
Order Type A-L Hub Separately (for Overhead Service).

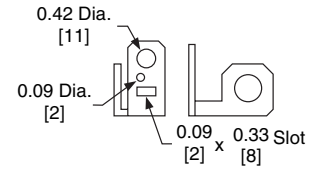
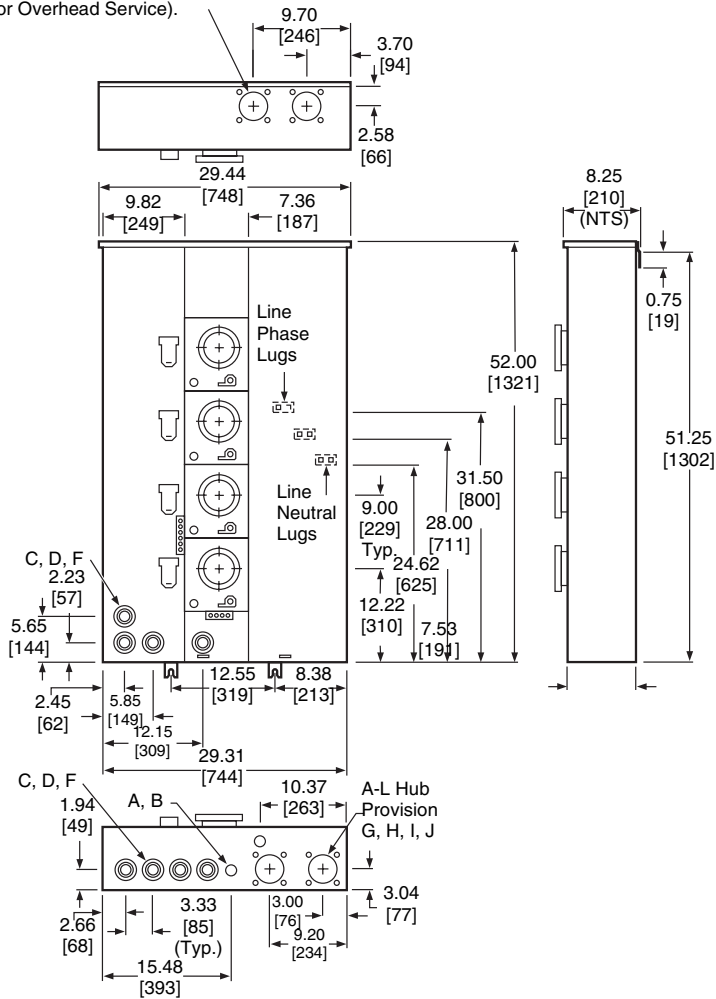

**Ringless Cover Latch**

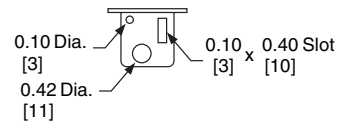

**Seal Bracket**

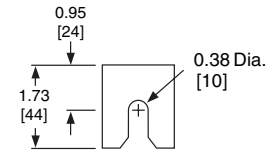

**Mounting Feet**

**MP64200  
MPR64200  
MPH64200**

Knockouts				
Symbol	Conduit Size		Hole Diameter	
	in.	mm	in.	mm
A	0.50	13	0.88	22
B	0.75	19	1.25	32
C	1.00	25	1.38	35
D	1.25	32	1.75	44
E	1.50	38	2.00	51
F	2.00	51	2.50	64
G	2.50	64	3.00	76
H	3.00	76	3.63	92
I	3.50	89	4.13	105
J	4.00	102	4.63	118

Dimensions: in. [mm]

# MP Meter-Pak™ Meter Centers Product Selection

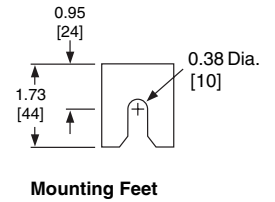
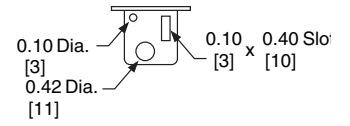
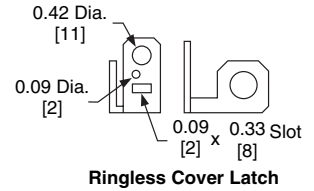
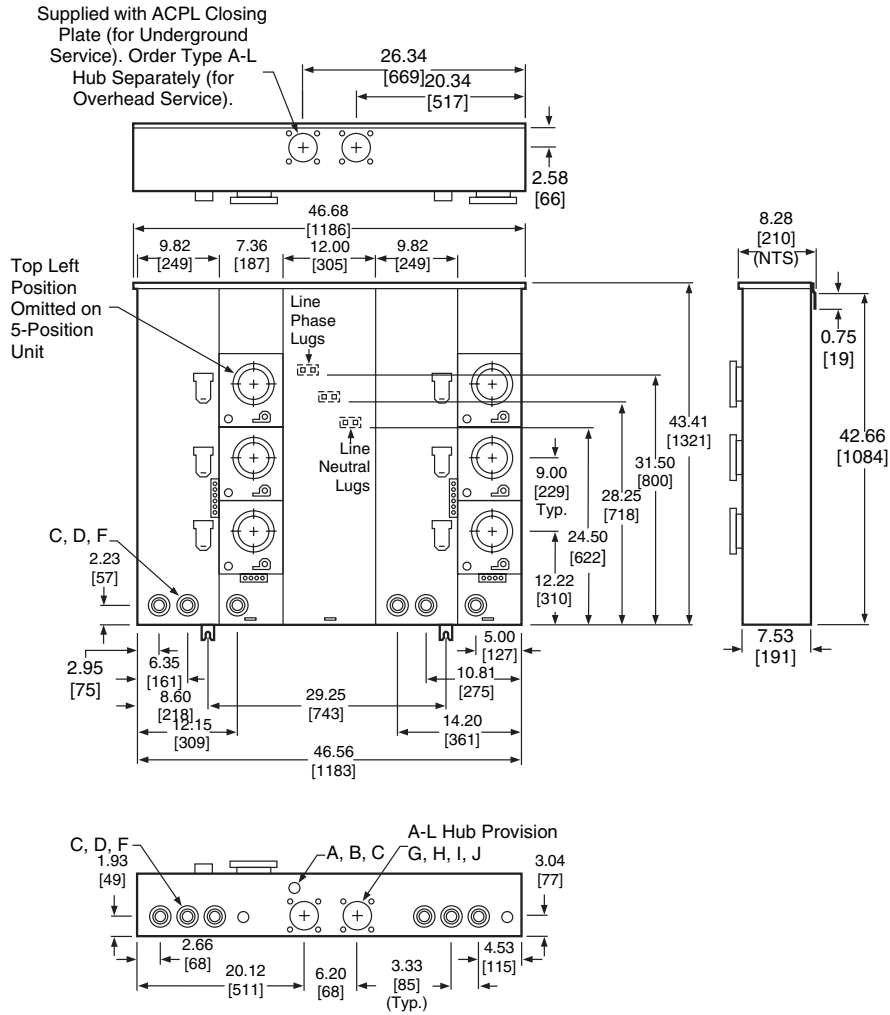

MP85200 MP86200  
MPR85200 MPR86200  
MPH85200 MPH86200

Dimensions: in.  
[mm]

Knockouts				
Symbol	Conduit Size		Hole Diameter	
	in.	mm	in.	mm
A	0.50	13	0.88	22
B	0.75	19	1.25	32
C	1.00	25	1.38	35
D	1.25	32	1.75	44
E	1.50	38	2.00	51
F	2.00	51	2.50	64
G	2.50	64	3.00	76
H	3.00	76	3.63	92
I	3.50	89	4.13	105
J	4.00	102	4.63	118

# MP Meter-Pak™ Meter Centers

## Product Selection

Supplied with ACPL Closing Plate (for Underground Service).  
Order Type A-L Hub Separately (for Overhead Service).

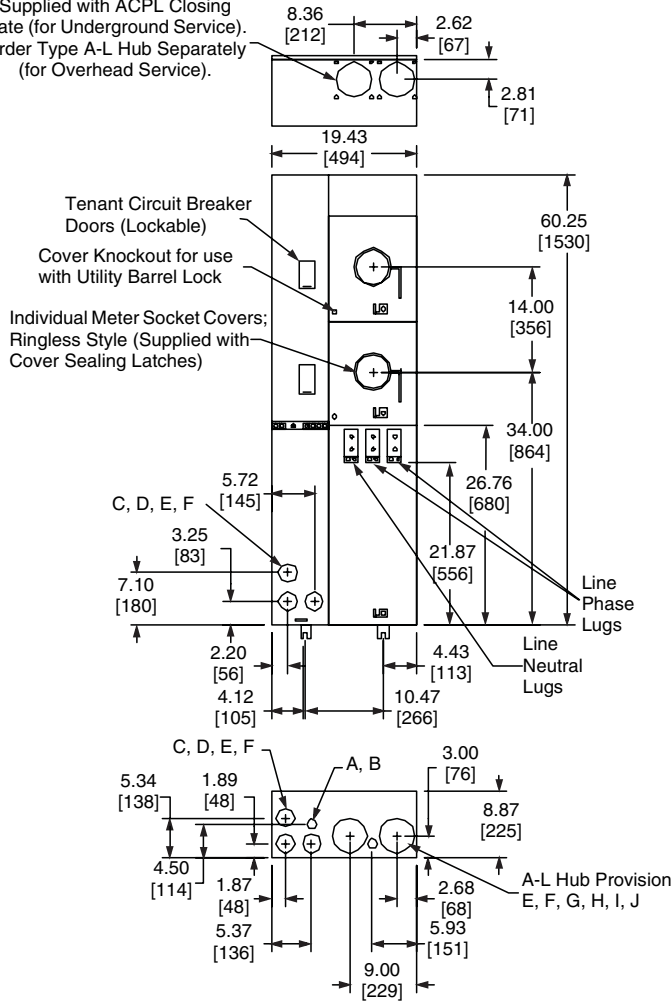

MPL32225

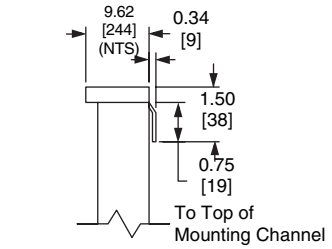

Mounting Channel Detail

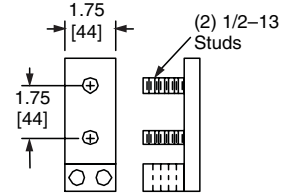

Lug Detail

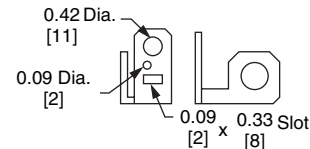

Ringless Cover Latch

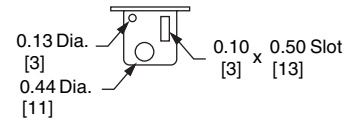

Seal Bracket

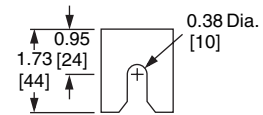

Mounting Foot

Knockouts				
Symbol	Conduit Size		Hole Diameter	
	in.	mm	in.	mm
A	0.50	13	0.88	22
B	0.75	19	1.25	32
C	1.00	25	1.38	35
D	1.25	32	1.75	44
E	1.50	38	2.00	51
F	2.00	51	2.50	64
G	2.50	64	3.00	76
H	3.00	76	3.63	92
I	3.50	89	4.13	105
J	4.00	102	4.63	118

Dimensions: in. [mm]

# MP Meter-Pak™ Meter Centers Product Selection

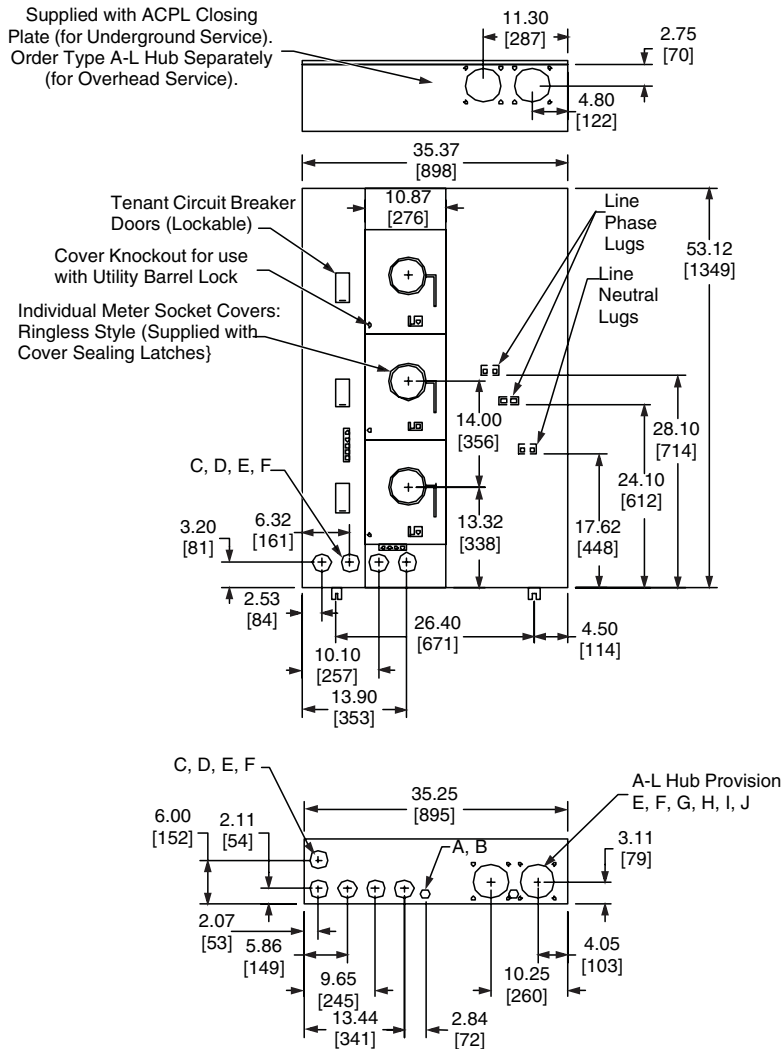

MPL53225

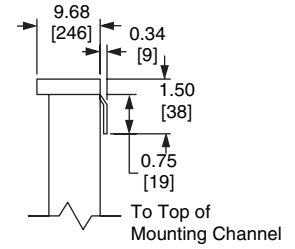

Mounting Channel Detail

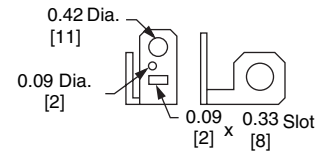

Ringless Cover Latch

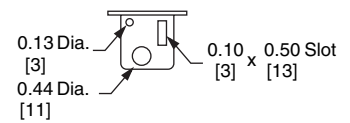

Seal Bracket

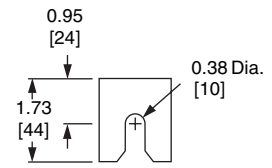

Mounting Foot

Dimensions: in. [mm]

Knockouts				
Symbol	Conduit Size		Hole Diameter	
	in.	mm	in.	mm
A	0.50	13	0.88	22
B	0.75	19	1.25	32
C	1.00	25	1.38	35
D	1.25	32	1.75	44
E	1.50	38	2.00	51
F	2.00	51	2.50	64
G	2.50	64	3.00	76
H	3.00	76	3.63	92
I	3.50	89	4.13	105
J	4.00	102	4.63	118

# MP Meter-Pak™ Meter Centers

## Product Selection

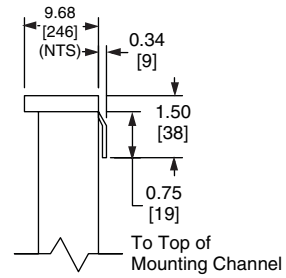
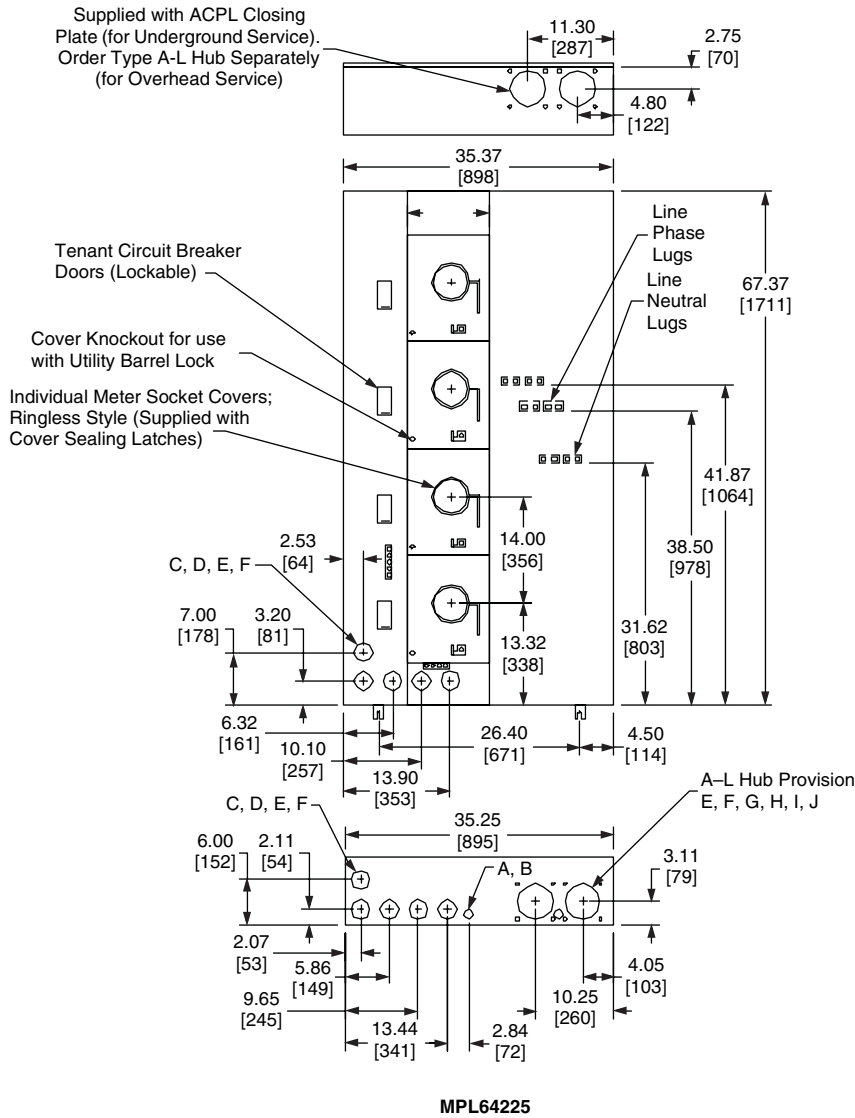

**Mounting Channel Detail**

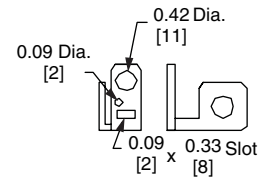

**Ringless Cover Latch**

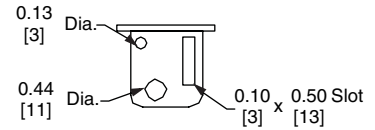

**Seal Bracket**

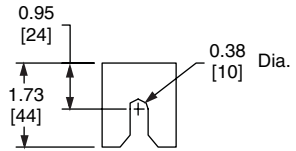

**Mounting Foot**

Dimensions: in. [mm]

Knockouts				
Symbol	Conduit Size		Hole Diameter	
	in.	mm	in.	mm
A	0.50	13	0.88	22
B	0.75	19	1.25	32
C	1.00	25	1.38	35
D	1.25	32	1.75	44
E	1.50	38	2.00	51
F	2.00	51	2.50	64
G	2.50	64	3.00	76
H	3.00	76	3.63	92
I	3.50	89	4.13	105
J	4.00	102	4.63	118

# MP Meter-Pak™ Meter Centers Product Selection

## 125 A Devices

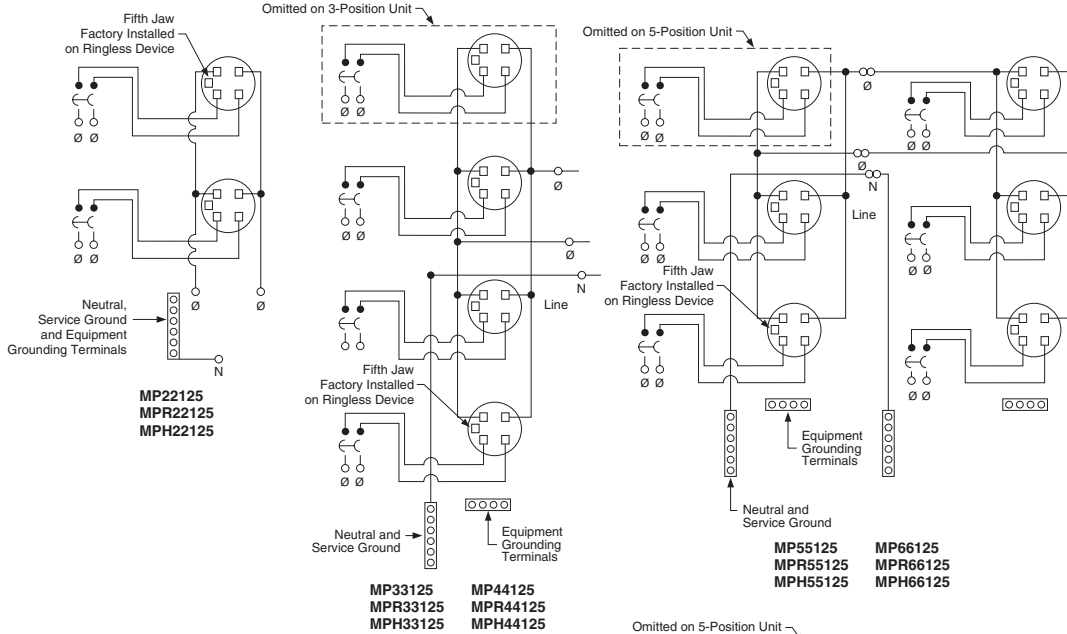

## 200 A Devices

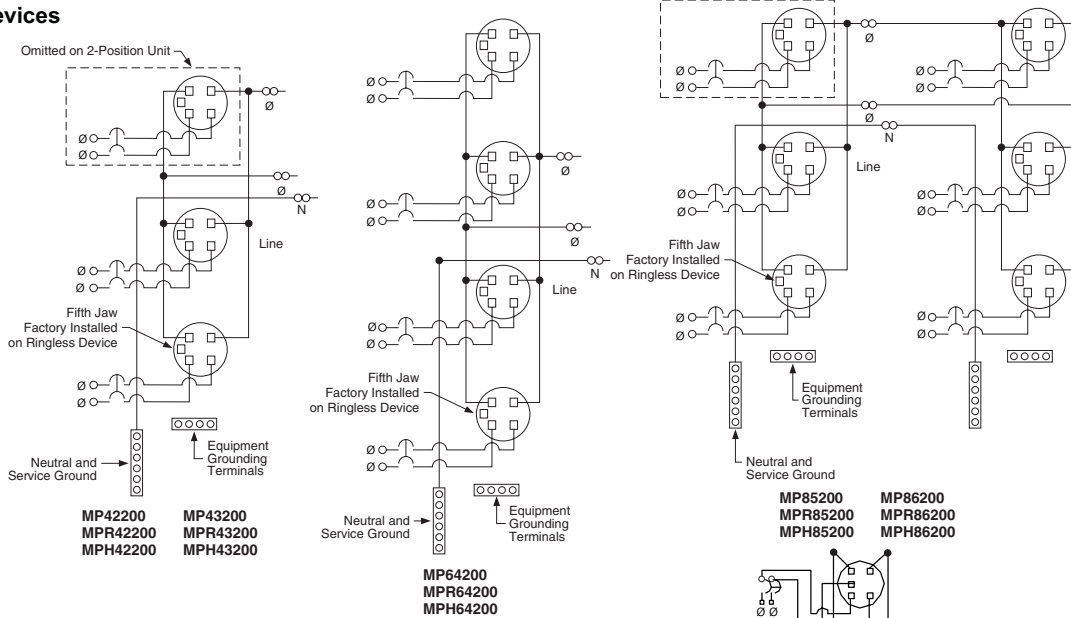

## 225 A Devices

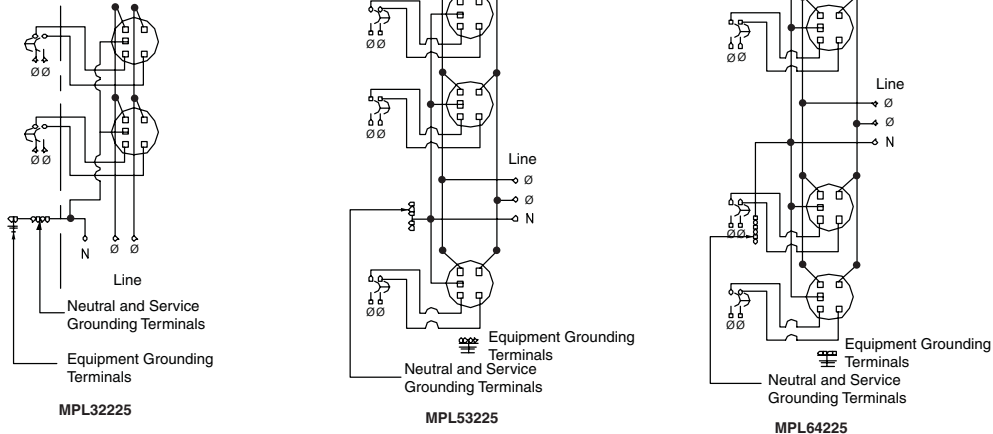

**Schneider Electric USA**

1601 Mercer Road  
Lexington, KY 40511 USA  
1-888-SquareD  
(1-888-778-2733)  
[www.us.SquareD.com](http://www.us.SquareD.com)

**Schneider Electric Canada**

19 Waterman Avenue,  
M4B 1 Y2  
Toronto, Ontario  
1-800-565-6699  
[www.schneider-electric.ca](http://www.schneider-electric.ca)

**Square D, [D], Meter-Pak, and QO are trademarks or registered trademarks of Schneider Electric and/or its affiliates in the United States and/or other countries. Other marks used herein may be the property of their respective owners.**

4141CT0701 © 2008 Schneider Electric All Rights Reserved