

# IEC Type Industrial Control Relays TeSys D-Line, K-Line, and SK-Line

Class 8501



## CONTENTS

Description	Page
Overview . . . . .	2
TeSys D-Line Ordering Information . . . . .	3
TeSys D-Line Dimensions . . . . .	9
TeSys D-Line Application Data . . . . .	10
K-Line Ordering Information . . . . .	13
K-Line Dimensions . . . . .	16
K-Line Application Data . . . . .	17
SK-Line Ordering Information . . . . .	19
Accessories . . . . .	21
Long Distance Control Data . . . . .	24



Schneider Electric Brands

## IEC Type Industrial Control Relays; TeSys D-Line, K-Line, and SK-Line Overview

### Description



TeSys D-Line Relays

These 600 volt relays are approved for use around the world. TeSys D-Line relays are usually mounted on 35 mm DIN 3 track, but can also be mounted directly to a panel. The fixed contacts in these relays have a NEMA A600 and Q600 ratings, in addition to the standard IEC ratings, making them suitable for use in most any control circuit. Low consumption versions of this relay are available for use with low level DC signals from a computer or a PLC. Adder decks can be added to a basic five pole relay to make it up to an 11 pole relay. The serrated silver-nickel contacts with wiping action provide excellent reliability in 12 or 24 volt control circuits. Special auxiliary contacts are available for switching low power down to 5 volts at 10 mA. Timer and mechanical latch attachments are available.

For more information on these relays, see pages 3 through 12.



K-Line Relays

These 600 volt relays are approved for use around the world. K-Line relays are usually mounted on 35mm DIN 3 track, but can also be mounted directly to a panel. One version of this relay can be printed circuit board mounted. A low power consumption version of this relay is available for use with low level DC signals from a computer or a PLC. The fixed contacts in these relays have a NEMA A600 and Q600 ratings, in addition to the standard IEC ratings, making them suitable for use in most any control circuit. Adder decks can be added to a basic four pole relay to make it up to a 8 pole relay. The serrated silver-nickel contacts with wiping action provide excellent reliability in 12 or 24 volt control circuits. An electronic timer attachment is available for this relay.

For more information on these relays, see pages 13 through 18.



SK-Line Relays

This two pole relay is the smallest IEC Type relay on the market. It is approved for use around the world. SK-Line relays are usually mounted on 35mm DIN 3 track. The fixed contacts in this relay have a NEMA A600 rating and a limited DC rating, in addition to the standard IEC ratings, making it suitable for use in most any AC control circuit and some DC control circuits. An adder deck can be added to the basic two pole AC relay to make it a 4 pole relay.

For more information on these relays, see pages 19 and 20.



# IEC Type Industrial Control Relays; TeSys D-Line, K-Line, and SK-Line TeSys Ordering Information

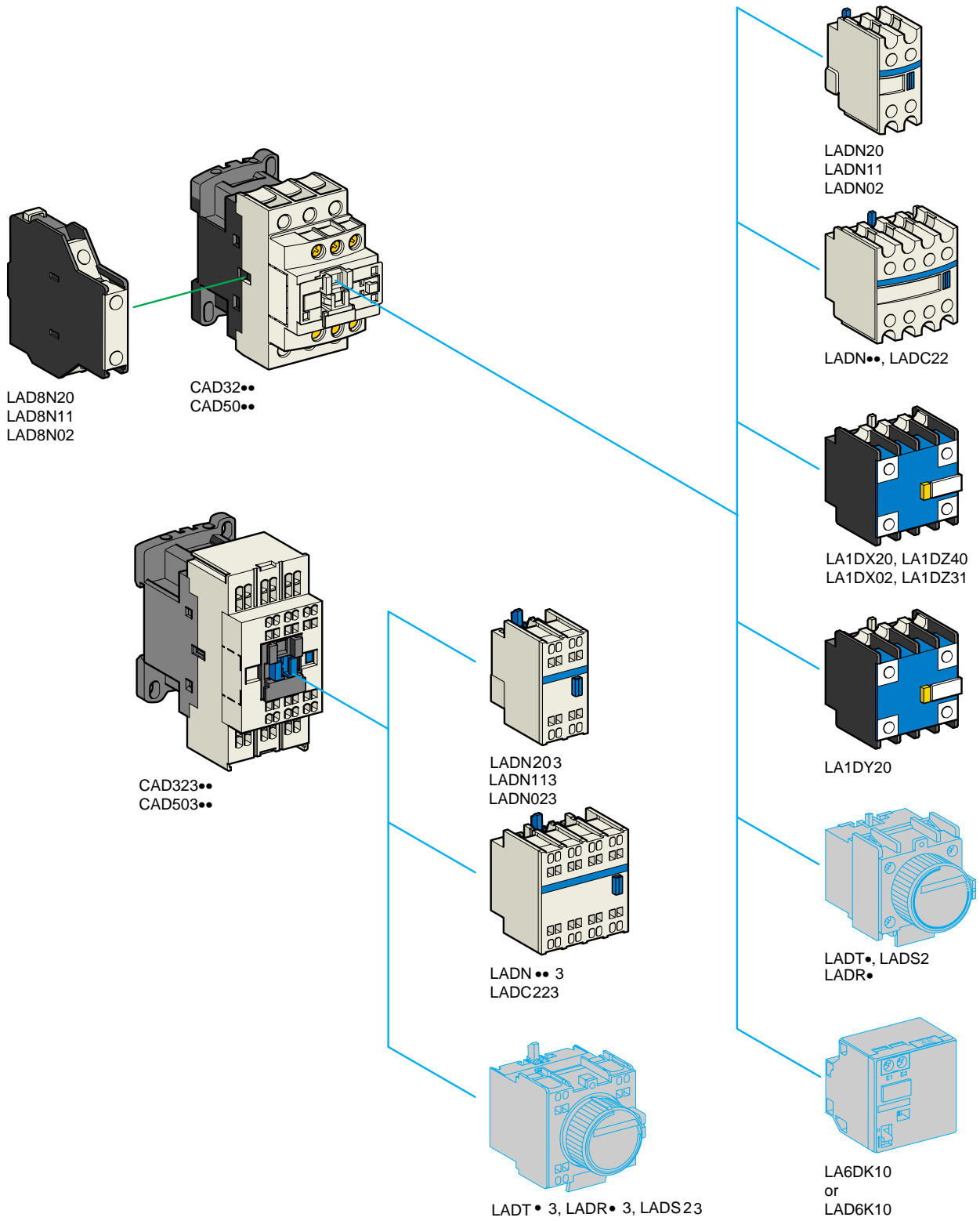

# IEC Type Industrial Control Relays; TeSys D-Line, K-Line, and SK-Line TeSys Ordering Information



CAD50

## Instantaneous Control Relays

Terminal Type	Number of Contacts	Contact Composition		Catalog Number	Weight lb. (kg)
		Normally Open	Normally Closed		
Screw Clamp	5	5	0	CAD50 ▲ *	1.28 (0.580)
		3	2	CAD32 ▲ *	1.28 (0.580)
Spring Terminal	5	5	0	CAD503 ▲ *	1.28 (0.580)
		3	2	CAD323 ▲ *	1.28 (0.580)



CAD32

## Instantaneous Auxiliary Contact Blocks (for use in normal operation environments)

Number of Contacts	Maximum Number per Device Clip-on Mounting		Termination Type	Contact Composition		Catalog Number	Weight lb. (kg)
	Front	Left Side Only		Normally Open	Normally Closed		
2	1	-	Screw Clamp	2	0	LADN20	0.07 (0.030)
				1	1	LADN11	0.07 (0.030)
				0	2	LADN02	0.07 (0.030)
			Spring Terminal	2	0	LADN203	0.07 (0.030)
				1	1	LADN113	0.07 (0.030)
				0	2	LADN023	0.07 (0.030)
4 +	1	-	Screw Clamp	2	0	LAD8N20	0.07 (0.030)
				1	1	LAD8N11	0.07 (0.030)
				0	2	LAD8N02	0.07 (0.030)
			Spring Terminal	4	0	LADN40	0.11 (0.050)
				3	1	LADN31	0.11 (0.050)
				2	2	LADN22	0.11 (0.050)
4 +	1	-	Screw Clamp	4	0	LADN40	0.11 (0.050)
				3	1	LADN31	0.11 (0.050)
				2	2	LADN22	0.11 (0.050)
			Spring Terminal	1	3	LADN13	0.11 (0.050)
				0	4	LADN04	0.11 (0.050)
				4	0	LADN403	0.11 (0.050)
4 +	1	-	Screw Clamp	4	0	LADN40	0.11 (0.050)
				3	1	LADN31	0.11 (0.050)
				2	2	LADN22	0.11 (0.050)
			Spring Terminal	1	3	LADN13	0.11 (0.050)
				0	4	LADN04	0.11 (0.050)
				2	2	LADN223	0.11 (0.050)
4 +	1	-	Screw Clamp	2	2	LADC22	0.11 (0.050)
				2	2	LADC223	0.11 (0.050)



CAD503



CAD323

## Instantaneous Auxiliary Contacts

### With Dust and Damp Protected Contacts (for use in particularly harsh industrial environments)

Number of Contacts	Maximum Number per Device	Contact Composition					Catalog Number	Weight lb. (kg)
		Sealed	❖	Normal				
2	1	2	-	-	-	-	LA1DX20	0.09 (0.040)
		-	2	-	-	-	LA1DX02	0.09 (0.040)
		2	-	2	-	-	LA1DY20	0.09 (0.040)
4 +	1	2	-	-	2	-	LA1DZ40	0.11 (0.050)
		2	-	-	1	1	LA1DZ31	0.11 (0.050)

## Common Coil Voltage Codes

### ac 50/60 Hz Coil (for additional voltage code options see page 7).

Volts	12	24	48	120	208	240	277	480	600
Code	J7	B7	E7	G7	LE7	U7	W7	T7	X7

### dc Coil (coils have built in suppression as standard)

Volts	12	24	36	48	60	72	110	125	220	250	440
Code	JD	BD	CD	ED	ND	SD	FD	GD	MD	UD	RD

### dc Low Consumption Coil (coils have built in suppression as standard)

Volts	5	12	24	48	72
Code	AL	JL	BL	EL	SL

- ❖ Grounding terminal points (2 terminals jumpered together; see diagram on page 8).
- + Auxiliary contact blocks with four contacts cannot be used on relays with low consumption coils.
- ▲ Add proper voltage code to end of catalog number.
- Includes 1 N/O and 1 N/C overlapping contact.
- \* For ring terminal configuration add "6" before coil voltage suffix. For example CAD32B7 becomes CAD326B7.



# IEC Type Industrial Control Relays; TeSys D-Line, K-Line, and SK-Line TeSys Ordering Information

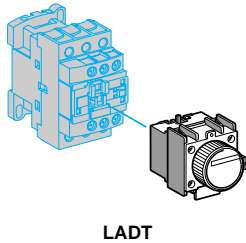

LADT

## Time Delay Auxiliary Contact Blocks

Number and Type of Contacts	Maximum Number per Device Front Mounting	Time Delay Type	Termination Type	Range	Catalog Number	Weight lb. (kg)
1 N/C and 1 N/O	1	On-Delay	Screw Clamp	0.1 to 3 sec. †	LADT0	0.13 (0.060)
				0.1 to 30 sec.	LADT2	0.13 (0.060)
				10 to 180 sec.	LADT4	0.13 (0.060)
			Spring Terminal	1 to 30 sec. ■	LADS2	0.13 (0.060)
				0.1 to 3 sec. †	LADT03	0.13 (0.060)
				0.1 to 30 sec.	LADT23	0.13 (0.060)
		Off-Delay	Screw Clamp	10 to 180 sec.	LADT43	0.13 (0.060)
				1 to 30 sec. ■	LADS23	0.13 (0.060)
				0.1 to 3 sec. †	LADR0	0.13 (0.060)
			Spring Terminal	0.1 to 30 sec.	LADR2	0.13 (0.060)
				10 to 180 sec.	LADR4	0.13 (0.060)
				0.1 to 30 sec. †	LADR03	0.13 (0.060)
				0.1 to 30 sec.	LADR23	0.13 (0.060)
				10 to 180 sec.	LADR43	0.13 (0.060)

(Lockout Cover, See page 7)

† With extended scale from 0.1 to 0.6 s.

■ With switching time of 40 ms ± 15 ms between opening of the N/C contact and closing of the N/O contact.

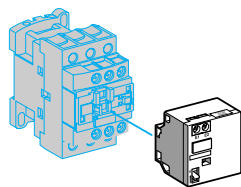

LA6DK

## Mechanical Latch Blocks ★

Unlatching Control	Maximum Number per Device Front mounting	Catalog Number	Weight lb. (kg)
Manual or electrical	1	LA6DK10 ▲	0.15 (0.070)
		LAD6K10 ▲	0.15 (0.070)

★ Power should not be simultaneously applied or maintained to the mechanical latching block and the CAD relay. The duration of the control signal to the mechanical latching block and the CAD relay should be ≥ 100 ms.

## Coil Suppressor Modules

These modules clip onto the right hand side of the control relay and the electrical connection is instantly made. Adding an input module is still possible.

### RC Circuits (Resistor-Capacitor)

- Effective protection for circuits highly sensitive to "high frequency" interference.
- Voltage limited to 3 Uc maximum and oscillating frequency limited to 400 Hz maximum.
- Slight increase in drop-out time (1.2 to 2 times the normal time).

For Mounting On:	Operational Voltage	Catalog Number	Weight lb. (kg)
CAD (Vac)	24 to 48 Vac	LAD4RCE	0.03 (0.012)
	110 to 240 Vac	LAD4RCU	0.03 (0.012)

### Varistors (Peak Limiting)

- Protection provided by limiting the transient voltage value to 2 Uc maximum.
- Maximum reduction of transient voltage peaks.
- Slight increase in drop-out time (1.1 to 1.5 times the normal time).

For Mounting On:	Operational Voltage	Catalog Number	Weight lb. (kg)
CAD (Vac)	24 to 48 Vac	LAD4VE	0.03 (0.012)
	50 to 127 Vac	LAD4VG	0.03 (0.012)
	110 to 250 Vac	LAD4VU	0.03 (0.012)

### Bidirectional Peak Limiting Diode

- Protection provided by limiting the transient voltage value to 2 Uc maximum.
- Maximum reduction of transient voltage peaks.

For Mounting On:	Operational Voltage	Catalog Number	Weight lb. (kg)
CAD (Vac)	24 Vac	LAD4TB	0.03 (0.012)
	72 Vac	LAD4TS	0.03 (0.012)

▲ Standard coil voltage codes.

Vac and Vdc	24	32/36	42/48	60/72	100	110/127	220/240	256/277	380/415
Code	B	C	E	EN	K	F	M	U	Q



# IEC Type Industrial Control Relays; TeSys D-Line, K-Line, and SK-Line TeSys Ordering Information

## Cabling Accessory

Description		Catalog Number	Weight lb (kg)	
Mounting Adaptor For adapting existing wiring to a new product	Without coil suppression	LAD4BB	0.04 (0.019)	
	With coil suppression	ac 24 to 48 V	LAD4BBVE	0.03 (0.014)
		ac 50 to 127 V	LAD4BBVG	0.03 (0.014)
		ac 110 to 250 V	LAD4BBVU	0.03 (0.014)

## Electronic Serial Timer Modules ▲

- Mounted using adaptor LAD4BB, to be ordered separately, see listing above.

On-delay Type			
Operational Voltage	Time Delay	Catalog Number	Weight lb (kg)
24 to 250 Vac/Vdc	0.1 to 2 s	LA4DT0U	0.09 (0.040)
	1.5 to 30 s	LA4DT2U	0.09 (0.040)
	25 to 500 s	LA4DT4U	0.09 (0.040)
Off-delay Type			
24 to 250 Vac/Vdc	0.1 to 2 s	LA4DR0U	0.11 (0.050)
	1.5 to 30 s	LA4DR2U	0.11 (0.050)
	25 to 500 s	LA4DR4U	0.11 (0.050)

## Auto-Man-Stop Control Modules

For local override operation tests with two-position "Auto-Man" switch and "O-I" switch

- Mounted using adaptor LAD4BB, to be ordered separately, see listing above.

Operational voltage	Catalog Number	Weight lb (kg)
24 to 100 Vac	LA4DMK	0.09 (0.040)

- ▲ For 24 V operation, the relay must be fitted with a 21 V coil (code Z7).



# IEC Type Industrial Control Relays; TeSys D-Line, K-Line, and SK-Line TeSys Ordering Information

## Accessories (to be ordered separately)

For Connection				
Description	For Mounting On:	Must be Ordered in Multiplies of:	Catalog Number	Weight lb. (kg)
For Marking				
Sheet of 64 self-adhesive blank labels 8 x 33	CAD, LAD (4 contacts), LA6DK	10	LAD21	0.04 (0.020)
Sheet of 112 self-adhesive blank labels 8 x 12	LAD (2 contacts), LADT	10	LAD22	0.04 (0.020)
Strips of blank, self-adhesive labels for printing by plotter (4 sets of 5 strips)	All products	35	LAD24	0.44 (0.200)
"SIS Label" label creation software for labels LAD-21 and 22	French version	1	XBY1FR	0.13 (0.060)
	English version	1	XBY1EN	0.13 (0.060)
For Protection				
Lockout cover	LADT, LADR	1	LA9D901	0.01 (0.005)
Relay cover preventing access to the moving contact carrier	CAD	1	LAD9ET1	0.008 (0.004)

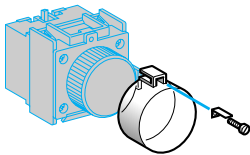

LA9D901

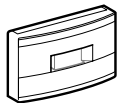

LAD9ET1

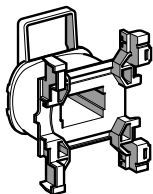

LXD1

## Replacement Coils (Vac)

### Specifications

Average consumption at 68 °F (20 °C):  
 - inrush (cos φ = 0.75) 50/60 Hz: 70 VA at 50 Hz  
 - sealed (cos φ = 0.3) 50/60 Hz: 8 VA at 60 Hz  
 Operating rate θ ≤ 140 °F (60 °C): 0.85 at 1.1 Uc

Coil Voltage Uc V	Average Resistance at 68 °F (20 °C) ± 10%	Inductance of Closed Circuit	Catalog Number 50/60 Hz	Voltage Code	Weight lb. (kg)
	Ω	H			
12	6.3	0.26	LXD1J7	J7	0.15 (0.070)
21 †	5.6	0.24	LXD1Z7	Z7	0.15 (0.070)
24	6.19	0.26	LXD1B7	B7	0.15 (0.070)
32	12.3	0.48	LXD1C7	C7	0.15 (0.070)
36	12.83	–	LXD1CC7	CC7	0.15 (0.070)
42	19.15	0.77	LXD1D7	D7	0.15 (0.070)
48	25	1	LXD1E7	E7	0.15 (0.070)
60	34.60	–	LXD1EE7	EE7	0.15 (0.070)
100	100.4	–	LXD1K7	K7	0.15 (0.070)
110	130	5.5	LXD1F7	F7	0.15 (0.070)
115	137.2	–	LXD1FE7	FE7	0.15 (0.070)
120	159	6.7	LXD1G7	G7	0.15 (0.070)
127	192.5	7.5	LXD1FC7	FC7	0.15 (0.070)
200	410.7	–	LXD1L7	L7	0.15 (0.070)
208	417	16	LXD1LL7	LL7	0.15 (0.070)
220/230	539	22	LXD1M7 ★	M7	0.15 (0.070)
230	595	21	LXD1P7	P7	0.15 (0.070)
230/240	645	25	LXD1U7 ■	U7	0.15 (0.070)
277	781	30	LXD1W7	W7	0.15 (0.070)
380/400	1580	60	LXD1Q7	Q7	0.15 (0.070)
400	1810	64	LXD1V7	V7	0.15 (0.070)
415	1938	74	LXD1N7	N7	0.15 (0.070)
440	2242	79	LXD1R7	R7	0.15 (0.070)
480	2300	85	LXD1T7	T7	0.15 (0.070)
600	3600	135	LXD1X7	X7	0.15 (0.070)
690	5600	190	LXD1Y7	Y7	0.15 (0.070)

- † Voltage for relays with serial timer modules, with 24 V supply.
- ★ This coil can be used on 240 V at 60 Hz.
- This coil can be used on 230/240 V at 50 Hz and on 240 V only at 60 Hz.



# IEC Type Industrial Control Relays; TeSys D-Line, K-Line, and SK-Line TeSys Terminal Configurations

Control Relays Instantaneous					
5 N/O CAD50		3 N.O + 2 N/C CAD32			
Instantaneous Auxiliary Contact Blocks					
1 N/O + 1 N/C LADN11	LAD8N11 ★	2 N/O LADN20	LAD8N20 ★	2 N/C LAD8N02	LADN02
★ The figures in brackets are for the device mounted on the RH side of the relay.					
2 N/O + 2 N/C LADN22	1 N/O + 3 N/C LADN13	4 N/O LADN40	4 N/C LADN04	3 N/O + 1 N/C LADN31	
With Dust and Damp Protected Contacts					
2 N/O + 2 N/C Including 1 N.O + 1 N/C Make Before Break LADC22	2 N/O Protected LA1DX20	2 N/C Protected LA1DX20	2 N/O Protected ▲ LA1DY20	2 N/O Protected + 2 N/O Non Protected LA1DZ40	2 N/O Protected + 1 N/O + 1 N/C Non Protected LA1DZ31
▲ With grounding terminal points.					
Time Delay Auxiliary Contact Blocks			Mechanical Latch Blocks		
On-Delay 1 N/O + 1 N/C LADT	LADS	Off-Delay 1 N/O + 1 N/C LADR	LA6DK10		
Electronic Serial Timer Modules		Auto-Man-Stop Modules			
On-Delay LA4DTU	Off-Delay LA4DRU	LA4DM			
(1) PLC					



# IEC Type Industrial Control Relays; TeSys D-Line, K-Line, and SK-Line TeSys Mounting Dimensions

**CAD (Vac Coil)**

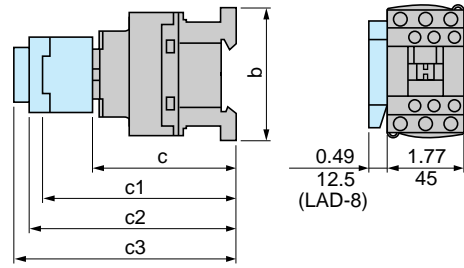

**CAD (Vdc Coil) or (Low Consumption Vdc Coil)**

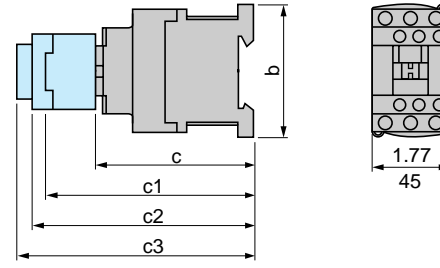

CAD -	32 50	323 503
b	3.03 (77)	3.90 (99)
c without cover or add-on blocks	3.31 (84)	3.31 (84)
with cover, without add-on blocks	3.39 (86)	3.39 (86)
c1 with LADN or C (2 or 4 contacts)	4.61 (117)	4.61 (117)
c2 with LA6DK10	5.08 (129)	5.08 (129)
c3 with LADT, R, S	5.39 (137)	5.39 (137)
with LADT, R, S and sealing cover	5.55 (141)	5.55 (141)

CAD -	32 50	323 503
b	3.03 (77)	3.90 (99)
c without cover or add-on blocks	3.66 (93)	3.66 (93)
with cover, without add-on blocks	3.74 (95)	3.74 (95)
c1 with LADN or C (2 or 4 contacts)	4.96 (126)	4.96 (126)
c2 with LA6DK10	5.43 (138)	5.43 (138)
c3 with LADT, R, S	5.75 (146)	5.75 (146)
with LADT, R, S and sealing cover	5.91 (150)	5.91 (150)

**CAD (Vac Coil)  
Panel Mounted**

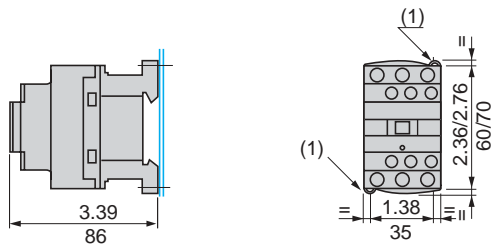

**CAD (Vac Coil) or (Low Consumption Coil)  
Panel Mounted**

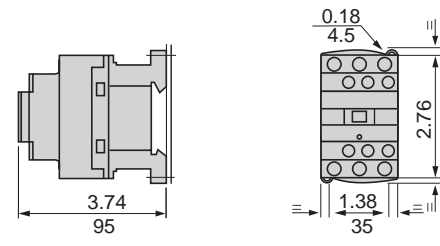

(1) Two elongated holes 0.18 x 0.35" (4.5 x 9 mm)

**CAD  
Mounted on AM1P Mounting Grid**

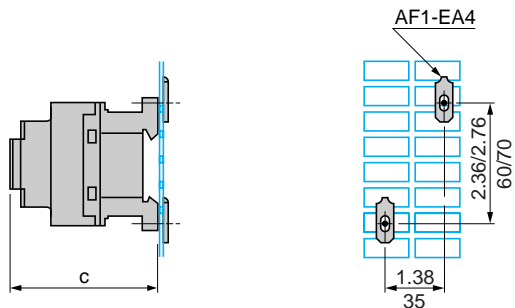

**Mounted on AM1DP200 or DE200 Mounting Track**

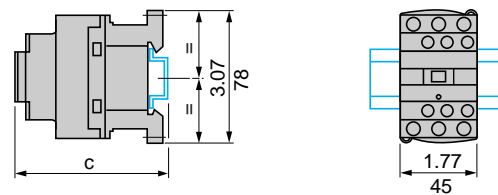

	CAD (Vac)	CAD (Vdc or LC)
c with cover	3.39 (86)	3.74 (95)

	CAD (Vac)	CAD (Vdc or LC)	
c (AM1DP200) (1)	3.46 (88)	3.82 (97)	c
c (AM1DE200) (1)	3.78 (96)	4.13 (105)	c

(1) With cover

Dimensions Inches  
mm

# IEC Type Industrial Control Relays; TeSys D-Line, K-Line, and SK-Line

## Tesys Application Data

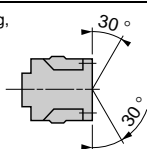
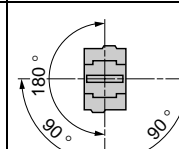
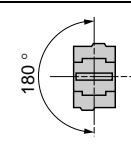
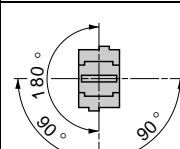
Type			CAD (Vac)	CAD (Vdc)	CAD (Vdc) Low Consumption
Rated Insulation Voltage (Ui)	Conforming to IEC 60947-1-1 Overvoltage category III and degree of pollution 3	V	690	690	690
	Conforming to UL, CSA	V	600	600	600
Rated Impulse Withstand Voltage (Uimp)	Conforming to IEC 60947-1-1	kV	6	6	6
Separation of Electrical Circuits	To IEC 536 and VDE 0106		Reinforced insulation up to 400 V		
Conforming to Standards			IEC 60947-1-1, N-F C 63-140, VDE 0660, BS 4794, EN 60947-5-15		
Approvals			UL File: E164353 CCN: NKCR CSA File: LR43364 Guide: 3211 03 CE		
Protective Treatment	Conforming to IEC 68		"TH" (Tropical Finish) See page 23 for details.		
Degree of Protection	Conforming to VDE 0106		Front face protected against direct finger contact IP 2X	Protection against direct finger contact	
Ambient Air Temperature Around the Device	Storage	°F (°C)	- 76 to 176 (- 60 to + 80)	- 76 to 176 (- 60 to + 80)	- 76 to 176 (- 60 to + 80)
	Operation, conforming to IEC 255 (80 to 110% UC)	°F (°C)	23 to 140 (- 5 to + 60)	23 to 140 (- 5 to + 60)	23 to 140 (- 5 to + 60)
	For operation at Uc	°F (°C)	- 40 to 158 (- 40 to + 70)	- 40 to 158 (- 40 to + 70)	- 40 to 158 (- 40 to + 70)
Maximum Operating Altitude	Without derating	ft (m)	9843 (3000)	9843 (3000)	9843 (3000)
Operating Positions	Without derating, in the following positions: 				
Shock Resistance ▲ Half sine wave for 11ms	Control relay open		10 gn	10 gn	10 gn
	Control relay closed		15 gn	15 gn	15 gn
Vibration Resistance ▲ 5 to 300 Hz	Control relay open		2 gn	2 gn	2gn
	Control relay closed		4 gn	4 gn	4 gn
Connection to Screw Clamp Terminals	Stranded wire without cable end	1 conductor	AWG (mm <sup>2</sup> ) # 18 to # 12 (1 to 4)	# 18 to # 12 (1 to 4)	# 18 to # 12 (1 to 4)
		2 conductors	AWG (mm <sup>2</sup> ) # 18 to # 12 (1 to 4)	# 18 to # 12 (1 to 4)	# 18 to # 12 (1 to 4)
	Stranded wire without cable end	1 conductor	AWG (mm <sup>2</sup> ) # 18 to # 12 (1 to 4)	# 18 to # 12 (1 to 4)	# 18 to # 12 (1 to 4)
		2 conductors	AWG (mm <sup>2</sup> ) # 18 to # 14 (1 to 2.5)	# 18 to # 14 (1 to 2.5)	# 18 to # 14 (1 to 2.5)
	Solid wire without cable end	1 conductor	AWG (mm <sup>2</sup> ) # 18 to # 12 (1 to 4)	# 18 to # 12 (1 to 4)	# 18 to # 12 (1 to 4)
		2 conductors	AWG (mm <sup>2</sup> ) # 18 to # 12 (1 to 4)	# 18 to # 12 (1 to 4)	# 18 to # 12 (1 to 4)
	Tightening torque		lb-in (N•m)	15 (1.7)	15 (1.7)
Connection to Spring Terminals	1 or 2 stranded or solid without cable end	AWG (mm <sup>2</sup> )	# 18 to # 14 (1 to 2.5)	# 18 to # 14 (1 to 2.5)	# 18 to # 14 (1 to 2.5)

▲ In the least favorable direction, without change of contact state, with coil supplied at Uc.



# IEC Type Industrial Control Relays; TeSys D-Line, K-Line, and SK-Line Tesys Application Data

## Control Circuit Characteristics

Type			CAD (Vac)	CAD (Vdc)	CAD (Vdc) Low Consumption	
Rated Control Circuit Voltage (Uc)		V	12 to 690	12 to 440	5 to 72	
Control Voltage Limits	Operation	With coil type: Vac 50/60 Hz	80 to 110% Uc at 50 Hz	-	-	
			85 to 110% Uc at 60 Hz	-	-	
	Drop-out	Vdc standard, wide range	-	70 to 125% Uc	70 to 125% Uc	
Average Consumption at 68 °F (20 °C) and at Uc	Vac Coil 50/60 Hz	VA	Inrush: 70 Hold-in: 8	- -	- -	
	Vdc Coil with standard coil	W	-	Inrush or hold-in: 5.4	Inrush or hold-in: 2.4	
Operating Time (at rated control circuit voltage and at 68 °F (20 °C))	Between coil energization and	- opening of the N/C contacts	ms	4 to 19	35 to 45	45 to 55
		- closing of the N/O contacts	ms	12 to 22	50 to 55	60 to 70
	Between coil de-energization and	- opening of the N/O contacts	ms	4 to 12	6 to 14	10 to 15
		- closing of the N/C contacts	ms	6 to 17	20	25
Short Supply Failures	Maximum duration without affecting hold-in of the device	ms	2	2	2	
Maximum Operating Rate	In operating cycles per second		3	3	3	
Mechanical Durability (in millions of operating cycles) †	With coil type: Vac 50/60 Hz		15	-	-	
	Vdc standard, wide range		-	30	30	
Time Constant L/R		ms	-	28	40	

† The product life expressed above is based on average usage and normal operating conditions. Actual operating life will vary with conditions. The above statements are not intended to, nor shall they create any expressed or implied warranties as to product operation or life. For information on the listed warranty offered on this product, refer to the Square D terms and conditions of sale found in the Square D Digest.

## Characteristics of Instantaneous Contacts incorporated in the Control Relay

Number of Contacts			5	
Rated Operational Voltage (Ue)	Up to	V	690	
Rated Insulation Voltage (Ui)	Conforming to IEC 60947-1-1	V	690	
	Conforming to UL, CSA	V	600	
Rated Conventional Thermal Current (Ith)	For ambient temperature ≤ 104 °F (40 °C)	A	10	
Frequency of Operational Current		Hz	25 to 400	
Minimum Switching Capacity	U min.	V	17	
	I min.	mA	5	
Short-circuit Protection	Conforming to IEC 60947-1-1		gG fuse: 10 A (10 Amp Class J Time delay)	
Rated Making Capacity	Conforming to IEC 60947-1-1 I rms		140 Aac, 250 Adc	
Short Time Rating	Permissible for	1 s	A	100
		500 ms	A	120
		100 ms	A	140
Insulation Resistance		MΩ	> 10	
Non-overlap time	Guaranteed between N/O and N/C contacts	ms	1.5 (on energization and on de-energization)	
Tightening Torque	Phillips n°2 and Ø 6	lb-in (N•m)	10.6 (1.2)	
Non-overlap Distance			Linked contacts in association with auxiliary contacts LADN	
Linked Contacts	According to draft standard IEC 60947-4-5		The three "N/O" contacts and the two "N/C" contacts of CADN32 are linked mechanically by one mobile contact holder.	



# IEC Type Industrial Control Relays; TeSys D-Line, K-Line, and SK-Line Tesys Application Data

## Contact Ratings

AC Ratings								DC Ratings			
Volts	Inductive 35% Power Factor						Resistive 75% Power Factor	Volts	Inductive		
	UL Rating	Make		Break		Cont. Amps			Make, Break & Cont. Amps	UL Rating	Make & ▲ Break Amps
		Amps	VA	Amps	VA						
120	A600	60	7200	6	720	10	10	125	Q600	0.55	2.5
240		30	7200	3	720	10	10	250		0.27	2.5
480		15	7200	1.5	720	10	10	600		0.10	2.5
600		12	7200	1.2	720	10	10				

▲ 69 VA maximum up to 300 volts.

### AC Supply, Categories AC-14 and AC-15 (conforming to IEC 60947-1-1)

Electrical durability (up to 3600 operating cycles/hours) on an inductive load such as the coil of an electromagnet: making power ( $\cos \phi 0.7$ ) = 10 times the power broken ( $\cos \phi 0.4$ )

	V	24	48	115	230	400	440	600
1 million operating cycles ▲	VA	60	120	280	560	960	1050	1440
3 million operating cycles ▲	VA	16	32	80	160	280	300	420
10 million operating cycles ▲	VA	4	8	20	40	70	80	100

### DC Supply, Categories DC-13

Electrical durability (up to 1200 operating cycles/hour) on an inductive load such as the coil of an electromagnet, without economy resistor, the time constant increasing with the power.

	V	24	48	125	250	440
1 million operating cycles ▲	W	120	90	75	68	61
3 million operating cycles ▲	W	70	50	38	33	28
10 million operating cycles ▲	W	25	18	14	12	10

Categories AC14 and AC15

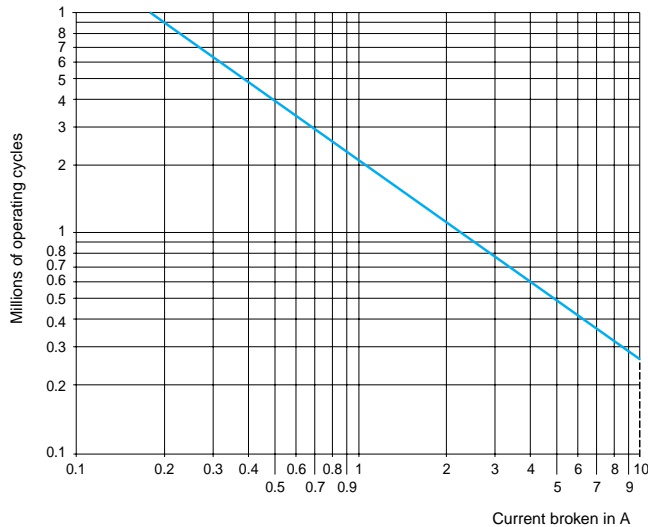

Category DC13

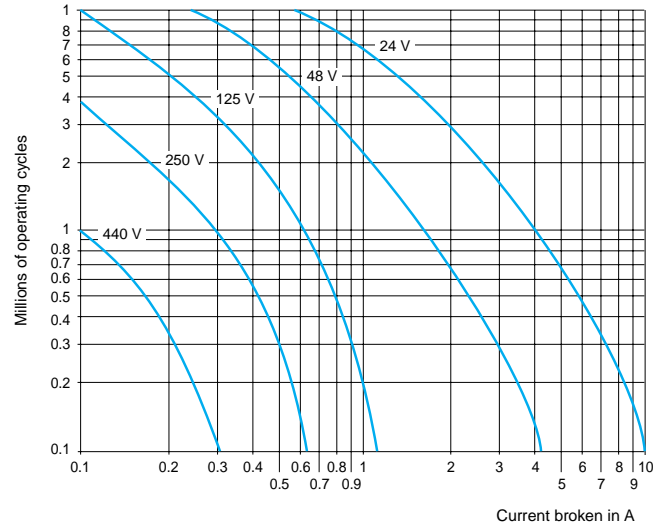

### Utilization Categories for Control Relays Conforming to IEC 60947-1-1

#### AC Applications

Category AC-14 (1)	This category applies to the switching of electromagnetic loads whose power drawn with the electromagnet closed is less than 72 VA. Application example: Switching the operating coil of contactors and relays.
Category AC-15 (1)	This category applies to the switching of electromagnetic loads whose power drawn with the electromagnet closed is more than 72 VA. Application example: Switching the operating coil of contactors.

#### DC Applications

Category DC-13	This category applies to the switching of electromagnetic loads for which the time taken to reach 95% of the steady state current ( $T = 0.95$ ) is equal to 6 times the power P drawn by the load (with $P \geq 50$ W).
----------------	--

▲ The product life expressed above is based on average usage and normal operating conditions. Actual operating life will vary with conditions. The above statements are not intended to, nor shall they create any expressed or implied warranties as to product operation or life. For information on the listed warranty offered on this product, refer to the Square D terms and conditions of sale found in the Square D Digest.

(1) Replaces category AC-11



# IEC Type Industrial Control Relays; TeSys D-Line, K-Line, and SK-Line K-Line Ordering Information

## Control Relays



**CA2KN40\*\***



**CA2KN403\*\***



**CA3KN407\*\***

- Mounting on 35 mm DIN3 track or 4 screw direct mounting.
- Screws in open "ready-to-tighten" position.

Control Circuit		Type of Termination	Contact Configuration		Catalog Number ♦	Weight lb (kg)
Supply	Consumption		N/O	N/C		
AC	4.5 VA	Screw clamp	4	0	CA2KN40**	0.40 (0.180)
			3	1	CA2KN31**	0.40 (0.180)
			2	2	CA2KN22**	0.40 (0.180)
		Spring Termination	4	0	CA2KN403**	0.40 (0.180)
			3	1	CA2KN313**	0.40 (0.180)
			2	2	CA2KN223**	0.40 (0.180)
		Faston 1 x 6.35 or 2 x 2.8	4	0	CA2KN407**	0.40 (0.180)
			3	1	CA2KN317**	0.40 (0.180)
			2	2	CA2KN227**	0.40 (0.180)
		Solder pins for printed circuit board	4	0	CA2KN405**	0.46 (0.210)
			3	1	CA2KN315**	0.46 (0.210)
			2	2	CA2KN225**	0.46 (0.210)
DC	3 W	Screw clamp	4	0	CA3KN40**	0.50 (0.225)
			3	1	CA3KN31**	0.50 (0.225)
			2	2	CA3KN22**	0.50 (0.225)
		Spring Termination	4	0	CA3KN403**	0.50 (0.225)
			3	1	CA3KN313**	0.50 (0.225)
			2	2	CA3KN223**	0.50 (0.225)
		Faston 1 x 6.35 or 2 x 2.8	4	0	CA3KN407**	0.50 (0.225)
			3	1	CA3KN317**	0.50 (0.225)
			2	2	CA3KN227**	0.50 (0.225)
		Solder pins for printed circuit board	4	0	CA3KN405**	0.56 (0.255)
			3	1	CA3KN315**	0.56 (0.255)
			2	2	CA3KN225**	0.56 (0.255)

## Low Consumption Control Relays

- Compatible with programmable controller outputs.
- LED indicator incorporated.
- Wide range coil (70 to 130% U<sub>c</sub>), suppressor fitted as standard.
- Mounting on 35 mm DIN3 track or 4 screw direct mounting.
- Screws in open "ready-to-tighten" position.



**CA4KN405\*\*\***

DC	1.8 W	Screw clamp	4	0	CA4KN40***	0.52 (0.235)
			3	1	CA4KN31***	0.52 (0.235)
			2	2	CA4KN22***	0.52 (0.235)
		Spring Termination	4	0	CA4KN403***	0.52 (0.235)
			3	1	CA4KN313***	0.52 (0.235)
			2	2	CA4KN223***	0.52 (0.235)
		Faston 1 x 6.35 or 2 x 2.8	4	0	CA4KN407***	0.52 (0.235)
			3	1	CA4KN317***	0.52 (0.235)
			2	2	CA4KN227***	0.52 (0.235)
		Solder pins for printed circuit board	4	0	CA4KN405***	0.58 (0.265)
			3	1	CA4KN315***	0.58 (0.265)
			2	2	CA4KN225***	0.58 (0.265)

♦ Complete catalog number by adding proper voltage code from page 14.

Application Data ..... 17  
 Dimensions ..... 16  
 Contact Configuration ..... 16  
 Accessories ..... 14-15



# IEC Type Industrial Control Relays; TeSys D-Line, K-Line, and SK-Line K-Line Ordering Informaiton

## Instantaneous Auxiliary Contact Blocks



LA1KN20

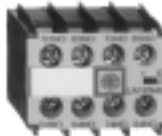

LA1KN40



LA1KN403



LA1KN407

Clip-on Front Mounting, 1 Block Per Control Relay					
Type of connection	Contact Configuration		Catalog Number	Weight lb (kg)	
	N/O	N/C			
Screw clamp	2	0	LA1KN20	0.10 (0.045)	
	0	2	LA1KN02	0.10 (0.045)	
	1	1	LA1KN11	0.10 (0.045)	
	4	0	LA1KN40 ▲	0.10 (0.045)	
	3	1	LA1KN31 ▲	0.10 (0.045)	
	2	2	LA1KN22 ▲	0.10 (0.045)	
	1	3	LA1KN13 ▲	0.10 (0.045)	
	0	4	LA1KN04 ▲	0.10 (0.045)	
	Spring Termination	2	0	LA1KN203	0.10 (0.045)
		1	1	LA1KN113	0.10 (0.045)
0		2	LA1KN023	0.10 (0.045)	
4		0	LA1KN403 ▲	0.10 (0.045)	
3		1	LA1KN313 ▲	0.10 (0.045)	
2		2	LA1KN223 ▲	0.10 (0.045)	
1		3	LA1KN133 ▲	0.10 (0.045)	
0		4	LA1KN043 ▲	0.10 (0.045)	
Faston 1 x 6.35 or 2 x 2.8		2	0	LA1KN207	0.10 (0.045)
		0	2	LA1KN027	0.10 (0.045)
	1	1	LA1KN117	0.10 (0.045)	
	4	0	LA1KN407 ▲	0.10 (0.045)	
	3	1	LA1KN317 ▲	0.10 (0.045)	
	2	2	LA1KN227 ▲	0.10 (0.045)	
	1	3	LA1KN137 ▲	0.10 (0.045)	
	0	4	LA1KN047 ▲	0.10 (0.045)	

▲ Not to be used on CA4KN relays

## Electronic Time Delay Attachment

- Relay output with common point changeover contact, 240 VAC or VDC, 2 A maximum.
- Control voltage: 85 to 110% U<sub>c</sub>.
- Maximum switching capacity: 250 VA or 150 W.
- Operating temperature: 14 to 140°F (-10 to 60°C).
- Reset time: 1.5 s during the time delay period, 0.5 s after the time delay period.

Clip-on Front Mounting, 1 Block per Control Relay					
Voltage	Type	Timing Range (s)	Contact Configuration	Catalog Number	Weight lb (kg)
24 to 48 Vac or Vdc	On-delay	1 to 30	1 N/O and 1 N/C with a common	LA2KT2E	0.09 (0.040)
110 to 240 Vac	On-delay	1 to 30	1 N/O and 1 N/C with a common	LA2KT2U	0.09 (0.040)

## Coil Voltages

### CA2K Control Relays

Volts ac 50/60 Hz	12	20	24	36	42	48	110	115	120	127	220/230	230	230/240	380/400	400	400/415	440	480	500	600	660/690
Code (85 to 110% U <sub>c</sub> )	J7	Z7	B7	C7	D7	E7	F7	FE7	G7	FC7		P7			V7		R7	T7	S7	X7	
Code (80 to 115% U <sub>c</sub> )											M7		U7	Q7		N7					Y7

Coils up through 240 V are available with built-in coil suppression. Add a 2 to the end of the appropriate voltage code. Example: **G72**.

### CA3K Control Relays (80 to 115% U<sub>c</sub>)

Volts dc	12	20	24	36	48	60	72	100	110	125	200	220	230	240	250
Code	JD	ZD	BD	CD	ED	ND	SD	KD	FD	GD	LD	MD	MPD	MUD	UD

Coils are available with built-in coil suppression. Add a 3 to the end of the appropriate voltage code. Example: **JD3**.

### CA4K Low Consumption Control Relays (wide range coil: 70 to 130% U<sub>c</sub>)

Volts dc	12	20	24	48	72	110	120
Code	JW3	ZW3	BW3	EW3	SW3	FW3	GW3

Relays ..... 13  
Application Data ..... 17  
Dimensions ..... 16  
Contact Configuration ..... 16



# IEC Type Industrial Control Relays; TeSys D-Line, K-Line, and SK-Line K-Line Ordering Information

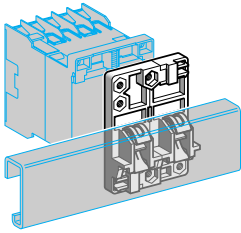

**LA9D973**

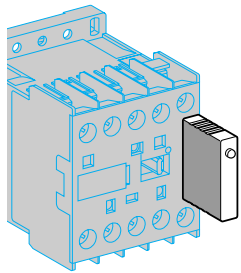

**LA4K•••**

Description	Application		Sold in Lots of	Catalog Number	Weight lb (kg)
Mounting Plates for Fixing	On 1 DIN1 track	Clip-on fixing	1	LA9D973	0.06 (0.025)
	On 2 DIN1 tracks	110/120 mm fixing centers	1	DX1AP25	0.14 (0.065)
Marker Holder	Clips onto Front of Relay		100	LA9D90	0.002 (0.001)
Clip-in Markers	See page 22				
Suppressor Modules Incorporating LED Indicator	Clips onto front of relay, with orientation device.  No tools required for connection.	For ac and dc voltages 12 to 24 V (varistor)	5	LA4KE1B ▲	0.02 (0.010)
		For ac and dc voltages 32 to 48 V (varistor)	5	LA4KE1E ▲	0.02 (0.010)
		For ac and dc voltages 50 to 129 V (varistor)	5	LA4KE1FC ▲	0.02 (0.010)
		For ac and dc voltages 130 to 250 V	5	LA4KE1UG ▲	0.02 (0.010)
		For dc voltages 12 to 24 V (diode + Zener diode)	5	LA4KC1B ※	0.02 (0.010)
		For dc voltages 32 to 48 V (diode + Zener diode)	5	LA4KC1E ※	0.02 (0.010)
		For ac voltages 220 to 250 V (RC)	5	LA4KA1U ▶	0.02 (0.010)

▲ Protection by limitation of the transient voltage to 2 Uc maximum.

Maximum reduction of the transient voltage peaks.

Slight time delay on drop-out (1.1 to 1.5 times normal).

※ No over voltage or oscillation frequency.

Polarized component.

Slight time delay on drop-out (1.1 to 1.5 times normal).

▶ Protection by limitation of the transient voltage to 3 Uc max. and limitation of the oscillation frequency.

Slight time delay on drop-out (1.2 times to 2 times normal).



# IEC Type Industrial Control Relays; TeSys D-Line, K-Line, and SK-Line K-Line Dimensions, and Terminal Configurations

## CA2, CA3, CA4K Control Relays

On Panel

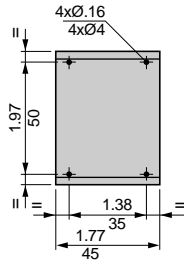
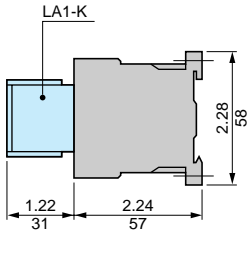

On Printed Circuit Board

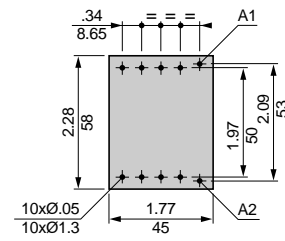

On AM1DP200 or AM1DE200 Track (35 mm DIN3)

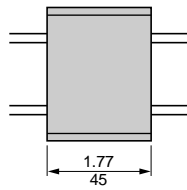
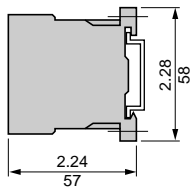

On Asymmetrical Rail with LA9D973 Clip-on Mounting Plate or DX1AP25 Mounting Plate (110/120 mm fixing centers)

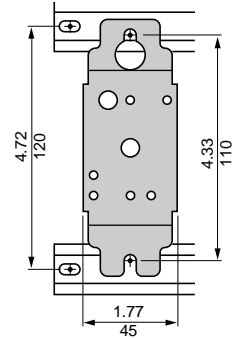
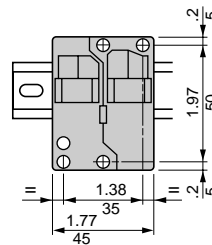
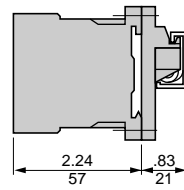

## LA2KT Electronic Time Delay Contact Blocks

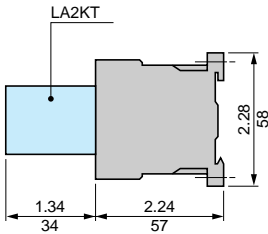
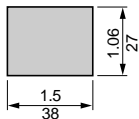
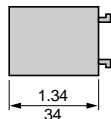

## LA4K Suppressor Modules

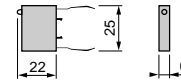

## LA4K on Auxiliary Control Relay

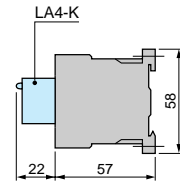

## CA2, CA3, CA4K Control Relays

4 N/O

3 N/O + 1 N/C

2 N/O + 2 N/C

CA4K Coil (suppressor scheme)

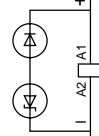
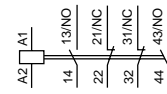
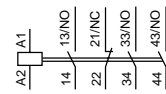
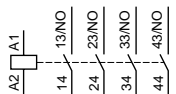

## LA1K Instantaneous Auxiliary Contact Blocks

For CA2, CA3, CA4K

2 N/O

2 N/C

1 N/O + 1 N/C

For CA2, CA3K

4 N/O

1 N/O + 3 N/C

3 N/O + 1 N/O

4 N/C

2 N/O + 2 N/C

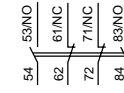
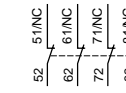
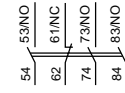
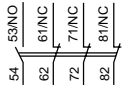
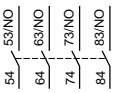
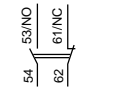
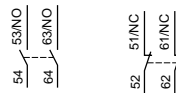

## LA2KT Electronic Time Delay Contact Blocks

For CA2, CA3, CA4K

1 C/O

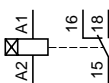

## LA4K Suppressor Modules

LA4KC Suppressor Module

LA4KE Suppressor Module

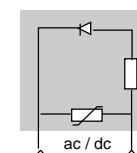
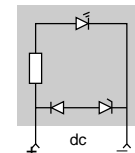



# IEC Type Industrial Control Relays; TeSys D-Line, K-Line, and SK-Line K-Line Application Data

## Environment

Conforming to Standards			IEC 60947-1-1, NF C 63-140, VDE 0660, BS 5424			
Approvals			UL File: E164353 CCN: NKCR CSA File: LR43364 Guide: 3211 03 CE			
Protective Treatment	Conforming to IEC 68 (DIN 50016)		"TC" (Climate proof) See page 23			
Degree of Protection	Conforming to VDE 0106		Protection against direct finger contact			
Ambient Air Temperature (around the device)	Storage	°F (°C)	-58 to 176 (-50 to 80)			
	Operation	°F (°C)	-13 to 122 (-25 to 50)			
Maximum Operating Altitude	Without derating	ft (m)	6562 (2000m)			
Operating Position	Vertical axis	Horizontal axis				
	Without derating		Without derating		With derating ▲	
					With derating ▲	
Flame Resistance	Conforming to UL 94		Self-extinguishing V1			
	Conforming to NF F 16-101 and 16-102		Conforming to requirement 2			
Shock Resistance (1/2 sine wave, 11 ms)	Control relay open		10 g			
	Control relay closed		15 g			
Vibration Resistance 5 to 300 Hz	Control relay open		2 g			
	Control relay closed		4 g			
Safe Circuit Separation	Conforming to VDE 0106 and IEC 536		VLSV ♦, up to 400 V			
Wire Range Screw Clamp Terminals	Solid wire	AWG (mm <sup>2</sup> )	Min. One #16 (1.5)	Max Two #12 (4)	Max to IEC 60947-1-1 One #12 (4) and One #14 (2.5)	
	Stranded wire without cable end	AWG (mm <sup>2</sup> )	One #20 (0.75)	Two #12 (4)	Two #14 (2.5)	
	Stranded wire with cable end	AWG (mm <sup>2</sup> )	One #22 (0.50)	One #16 (1.5) and One #14 (2.5)	One #16 (1.5) and One #14 (2.5)	
Spring Terminal Connection	Solid Wire	AWG (mm <sup>2</sup> )	One #20 (0.75)	One #16 (1.5)	Two #16 (1.5)	
	Stranded Wire without Cable End	AWG (mm <sup>2</sup> )	One #20 (0.75)	One #16 (1.5)	Two #16 (1.5)	
Faston Connectors	Faston Connector	in (mm)	Two 0.110 (2.8) or one 0.250 (6.35)			
Solder Pins for Printed Circuit Board	With locating device between power circuit and control circuit		4 mm x 35 microns			
Tightening Torque	Phillips head n° 2 and Ø 6		lb-in (N•m) 7.1 - 11.5 (0.8 - 1.3)			
Terminal Referencing	Conforming to standards EN 50005 and EN 50011		Up to 8 contacts			

- ▲ Very low safety voltage.
- ♦ Contact your local field sales office.

## Control Circuit Characteristics

Type			CA2K	CA3K	CA4K
Rated Control Circuit Voltage (Uc)		V	12 to 690 ac	12 to 250 dc	12 to 72 dc
Control Voltage Limits 122 °F (≤ 50 °C) single voltage coil	For operation		80 to 115% Uc	80 to 115% Uc	70 to 130% U
	For drop-out		≤ 20% Uc	≤ 10% Uc	≤ 10% Uc
Average Consumption at 68 °F (20 °C) and at Uc	Inrush		30 VA	3 W	1.8 W
	Sealed		4.5 VA	3 W	1.8 W
Heat Dissipation		W	1.3	3	1.8
Operating Time at 68 °F (20 °C) and at Uc	Between coil energization and - opening of the N/C contacts - closing of the N/O contacts ms ms	ms ms	5 to 15 10 to 20	25 to 35 30 to 40	25 to 35 30 to 40
	Between coil de-energization and - opening of the N/O contacts - closing of the N/C contacts	ms ms	10 to 20 15 to 25	10 15	10 to 20 15 to 25
Maximum Immunity to Micro Breaks		ms	2	2	2
Maximum Operating Rate	In operating cycles per hour		10,000	10,000	6000
Mechanical Durability ♦ at Uc In millions of operating cycles	50/60 Hz coil		10	–	–
	Standard dc coil		–	20	–
	Wide range dc coil		–	–	30

The product life expressed above is based on average usage and normal operating conditions. Actual operating life will vary with conditions. The above statements are not intended to, nor shall they create any expressed or implied warranties as to product operation or life. For information on the listed warranty offered on this product, refer to the Square D terms and conditions of sale found in the Square D Digest.



# IEC Type Industrial Control Relays; TeSys D-Line, K-Line, and SK-Line K-Line Application Data

## Contact Characteristics of Control Relays and Instantaneous Contact Blocks

Number of Contacts	On CA•K		4
	On LA1K		2 or 4
	CA2K		2 or 4
	CA3K		2 or 4
	CA4K		2
Rated Operational Voltage (Ue)	Up to	V	690
Rated Insulation Voltage (Ui)	Conforming to BS 5424	V	690
	Conforming to UL 508	V	600
	Conforming to IEC 60947-1-1	V	690
	Conforming to VDE 0110 group C	V	750
	Conforming to CSA C 22-2 n° 14	V	600
Conventional Thermal Current (Ith)	For Ambient Temperature ≤ 122 °F (50 °C)	A	10
Frequency Limits of Operational Current		Hz	Up to 400
Minimum Switching Capacity	Minimum voltage (DIN 19 240)	V	17
	Minimum current	mA	5
Short-circuit Protection	Conforming to IEC 60947-1-1 and VDE 0660, gG (gI) fuse	A	10 (10 Amp Class J Time delay)
Rated Making Capacity	Conforming to IEC 60947-1-1	I rms	A 110
Overload Current	Permissible for	1 s	A 80
		500 ms	A 90
		100 ms	A 110
Impedance		MΩ	> 10
Non-overlap distance	Positively guided contacts ♦ as per INRS and BIA spec	mm	0.5
UL508 Contact Rating	See page 20 for details		A600, Q600

♦ Positively guided contacts: CNA approved.

### Operational Power of Contacts ♦

Conforming to IEC 60947-1-1

1 million operating cycles  
3 million operating cycles  
10 million operating cycles  
Occasional making capacity

1 Breaking limit of contacts valid for:  
- maximum of 50 operating cycles  
at 10 s intervals (breaking current  
= making current x cos φ 0.7).

2 Electrical durability of contacts for:  
- 1 million operating cycles (2a)  
- 3 million operating cycles (2b)  
- 10 million operating cycles (2c).

3 Breaking limit of contacts valid for:  
- maximum of 20 operating cycles  
at 10 s intervals with current passing  
for 0.5 s per operating cycle.

4 Thermal limit

### AC Supply, Category AC-15 ♦

Electrical durability (valid up to 3600 operating cycles per hour on an inductive load such as the coil of an electromagnet: making current (cos φ 0.7) = 10 times breaking current (cos φ 0.4).

		110/	220/	380/	600/	
V	24	48	127	230	400	440 690
VA	48	96	240	440	800	880 1200
VA	17	34	86	158	288	317 500
VA	7	14	36	66	120	132 200
VA	1000	2050	5000	10 000	14 000	13 000 9000

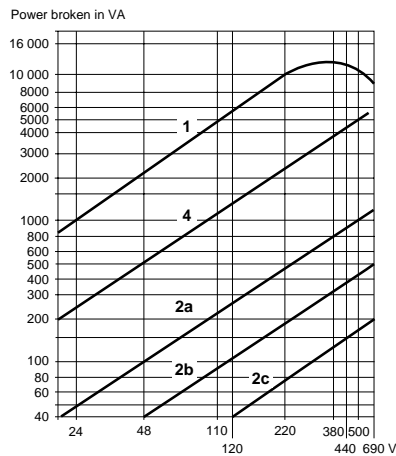

### DC Supply, Category DC-13 ♦

Electrical durability (valid up to 1200 operating cycles per hour on an inductive load such as the coil of an electromagnet, without economy resistor, the time constant increasing with the load).

V	24	48	110	220	440	600
W	120	80	60	52	51	50
W	55	38	30	28	26	25
W	15	11	9	8	7	6
W	720	600	400	300	230	200

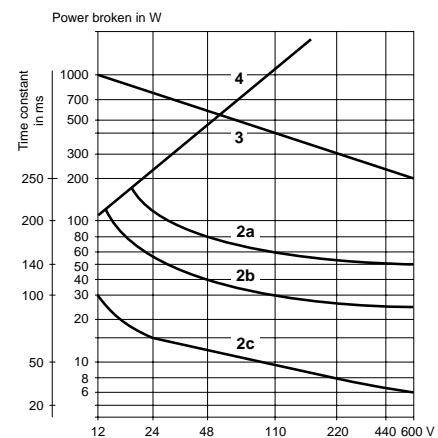

♦ The product life expressed above is based on average usage and normal operating conditions. Actual operating life will vary with conditions. The above statements are not intended to, nor shall they create any expressed or implied warranties as to product operation or life. For information on the listed warranty offered on this product, refer to the Square D terms and conditions of sale found in the Square D Digest.

### Utilization Categories for Control Relays Conforming to IEC 60947-1-1

<b>AC Applications</b>	Category AC-15 (1)	This category applies to the switching of electromagnetic loads whose power drawn with the electromagnet closed is more than 72 VA. Application example: Switching the operating coil of contactors.
<b>DC Applications</b>	Category DC-13 (2)	This category applies to the switching of electromagnetic loads for which the time taken to reach 95% of the steady state current (T = 0.95) is equal to 6 times the power P drawn by the load (with P ≥ 50 W). Application example: Switching the operating coil of contactors without economy resistor.

- (1) Replaces category AC-11  
(2) Replaces category DC-13



# IEC Type Industrial Control Relays; TeSys D-Line, K-Line, and SK-Line SK-Line Ordering Information



CAZSK11G7

- Miniature size saves space
- Mounts on 35mm DIN3 track or can be mounted directly to a panel
- Up to 4 poles

Control Circuit Supply	Consumption	Type of Termination	Contact Configuration		Catalog Number	Weight lb (kg)
			N/O	N/C		
AC	4.2 VA	Screw clamp	1	1	CA2SK11 ▲	0.24 (0.109)
			2	0	CA2SK20 ▲	0.24 (0.109)
DC	2.2 W	Screw clamp	1	1	CA3SK11 ▲	0.24 (0.109)
			2	0	CA3SK20 ▲	0.24 (0.109)



LA1SK11

## Contact Adder Decks

Used to expand the CA2SK20 two pole relays to a four pole relay.

Type of Termination	Contact Configuration		Catalog Number	Weight lb (kg)
	N/O	N/C		
Screw clamp	2	0	LA1SK20	0.05 (0.022)
	1	1	LA1SK11	0.05 (0.022)
	0	2	LA1SK02	0.05 (0.022)



LA4SKE1U

## Transient suppressor module

Dampens the voltage spike that may occur when the relay coil is de-energized. The spike may adversely affect solid state equipment near the relay. The transient suppressor module snaps into a cavity located in the side of the relay. These modules can be used with CA2SK and CA3SK relays.

Control Circuit Voltage	Catalog Number	Weight lb (kg)
24-48 V 50/60 Hz 24-48 Vdc	LA4SKE1E	0.02 (0.010)
110-250 V 50/60 Hz 110-250 Vdc	LA4SKE1U	0.02 (0.010)

## Coil Voltage Codes

Voltage	12	24	36	48	110	120	220	230	240	380	400	480
50/60 Hz (CA2SK relays)	—	B7	—	E7	F7	G7	M7	P7	U7	Q7	V7	T7
DC (CA3SK relays)	JD	—	CD	ED	SD	—	—	—	—	—	—	—

▲ Add proper voltage code to the end of the catalog number.



# IEC Type Industrial Control Relays; TeSys D-Line, K-Line, and SK-Line SK-Line Ordering Information

## Environment

Type		CA2	CA3
Conforming to Standards		IEC337-1, 947-1, 947-5, NF C 63-140, VDE0660, BS4794	
Approvals		UL Listed File E164353 CCN NKCR, CSA File LR12721 Class 3211 03, SEMKO, SEV, DEMKO, CE	
Operating Temperature Range		°F (°C)	-4 to 131 (-20 to 55)
Wire Range	Stranded wire	AWG (mm <sup>2</sup> )	Two #20 (0.75) to #16 (1.5)
	Solid wire	AWG (mm <sup>2</sup> )	Two #18 (1) to #14 (2.5)

## Control circuit characteristics

Type			CA2	CA3
Rated Insulation Voltage	Conforming to UL508	V	600	600
	Conforming to VDE 0110 Group C	V	660	660
Rated Coil Voltage U <sub>c</sub>		V	24 to 600	12 to 220
Permissible Voltage Variation			+10/-20% U <sub>c</sub>	
Average Consumption	Inrush		15.5 VA	2.2 W
	Sealed		4.2 VA	2.2 W
Operating Time	Pick-up	ms	8 to 16	10 to 18
	Drop-out	ms	6 to 8	4 to 6
Mechanical Life	In millions of operations		10	10

## Contact Ratings

AC							DC			
Volts	Inductive 35% PF						Resistive 75% PF		Volts	Continuous Amps
	UL Rating	Make		Break		Continuous Amps	Make, Break & Cont. Amps			
		Amps	VA	Amps	VA					
120	A600	60	7200	6	720	10	10	24	3	
240		30	7200	3	720	10	10	60	2	
480		15	7200	1.5	720	10	10	110	0.8	
600		12	7200	1.2	720	10	10	240	0.2	

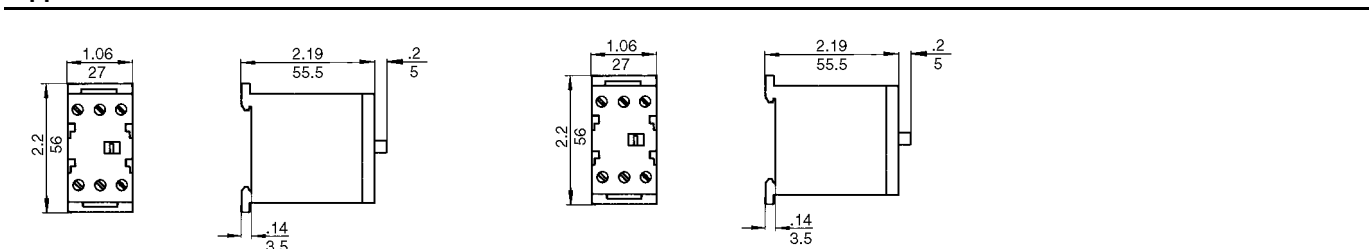

## Approximate dimensions



## Contact Configurations

Relays		Contact adder decks		
2 N/O	1 N/O and 1 N/C	2 N/O	1 N/O and 1 N/O	2 N/C

# IEC Type Industrial Control Relays; TeSys D-Line, K-Line, and SK-Line Accessories

Mounting Track				Mounting Track					
Description	Length	Catalog Number Class 9080 Type MH**	Std. ● Pack	Description	Length	Catalog Number	Std. ● Pack	Weight lb (kg)	
Symmetrical rail 35 x 7.5mm (1.38 x 0.295") in compliance with EN50022 standard (DIN 46277-3)	0.08 m / 3"	9080MH203	10	 15 mm depth, 1 mm steel, zinc chromated	2 m / 78.74"	AM1ED200	10	2.9 (1.31)	
	0.10 m / 4"	9080MH204							
	0.13m / 5"	9080MH205							
	0.15 m / 6"	9080MH206							
	0.18 m / 7"	9080MH207							
	0.20 m / 8"	9080MH208							
	0.23 m / 9"	9080MH209							
	0.25 m / 10"	9080MH210							
	0.28 m / 11"	9080MH211							
	0.30 m / 12"	9080MH212							
	0.33 m / 13"	9080MH213							
	0.36 m / 14"	9080MH214							
	0.38 m / 15"	9080MH215							
	0.41 m / 16"	9080MH216							
	0.43 m / 17"	9080MH217							
	0.46 m / 18"	9080MH218							
	0.50 m / 19.68"	9080MH220							
	1 m / 39.37"	9080MH239							
	2 m / 78.74"	9080MH279							
	Galvanized steel, prepunched	0.08 m / 3"	9080MH303	10	 7.5 mm depth, 1 mm steel, zinc chromated EN50022 & NF C63-015	2 m / 78.74"	AM1DP200	10	1.4 (0.65)
		0.10 m / 4"	9080MH304						
		0.13m / 5"	9080MH305						
		0.15 m / 6"	9080MH306						
		0.18 m / 7"	9080MH307						
		0.20 m / 8"	9080MH308						
		0.23 m / 9"	9080MH309						
		0.25 m / 10"	9080MH310						
0.28 m / 11"		9080MH311							
0.30 m / 12"		9080MH312							
0.33 m / 13"	9080MH313								
0.36 m / 14"	9080MH314								
0.38 m / 15"	9080MH315								
0.41 m / 16"	9080MH316								
0.43 m / 17"	9080MH317								
0.46 m / 18"	9080MH318								
0.50 m / 19.68"	9080MH320								
1 m / 39.37"	9080MH339								
2 m / 78.74"	9080MH379								
High rise track	Aluminum	1 m / 39.37"	9080MH439	2					

● Orders must specify standard packages or multiples of that quantity

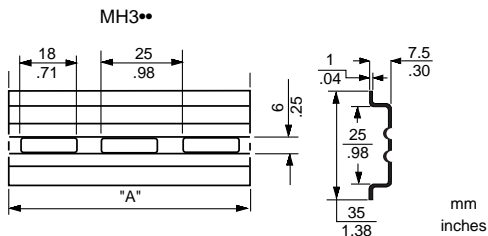

### Angle bracket kit

For mounting 9080 GH or MH track to a panel at 45° angle. Includes 2 brackets and hardware for mounting the track to the brackets.



9080MH82

1

### End Clamps

Metal end clamp for 35 mm DIN 3 track, 8 mm (0.31") wide



AB1AB8M35

100

### AM1DE200

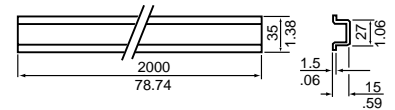

### AM1ED200

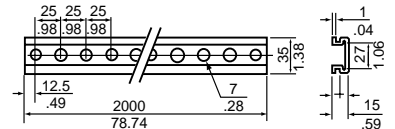

### AM1DP200

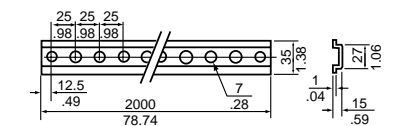

### DZ5MB201

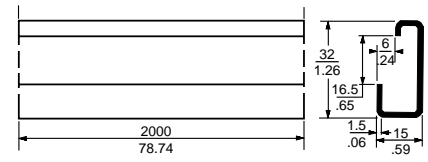

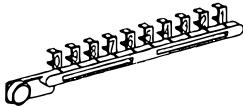
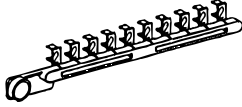
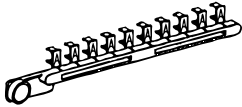
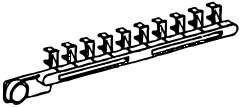

# IEC Type Industrial Control Relays; TeSys D-Line, K-Line, and SK-Line K-Line and SK-Line Accessories

## Clip-in Marker Strips ▲

10 Identical Numbers (or symbols)		10 Numbers 0 to 9		10 Identical Letters		10 Identical Letters	
AB1R●●		AB1R11		AB1G●		AB1G●	
							
Sold in Lots of 25 Identical Strips		Sold in Lots of 25 Identical Strips		Sold in Lots of 25 Identical Strips		Sold in Lots of 25 Identical Strips	
Unit Weight: 2g		Unit Weight: 2g		Unit Weight: 2g		Unit Weight: 2g	
Marking	Reference of 10-number tag strip	Marking	Reference of 10-number tag strip	Marking	Reference of 10-number tag strip	Marking	Reference of 10-number tag strip
Blank	AB1RV	0-9	AB1R11	A	AB1GA	N	AB1GN
1	AB1R1			B	AB1GB	O	AB1GO
2	AB1R2			C	AB1GC	P	AB1GP
3	AB1R3			D	AB1GD	Q	AB1GQ
4	AB1R4			E	AB1GE	R	AB1GR
5	AB1R5			F	AB1GF	S	AB1GS
6	AB1R6			G	AB1GG	T	AB1GT
7	AB1R7			H	AB1GH	U	AB1GU
8	AB1R8			I	AB1GI	V	AB1GV
9	AB1R9			J	AB1GJ	W	AB1GW
0	AB1R0			K	AB1GK	X	AB1GX
+	AB1R12			L	AB1GL	Y	AB1GY
—	AB1R13			M	AB1GM	Z	AB1GZ

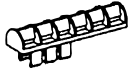
## Marking Components

Holder for 6 Markers	Blank Clip-in Marker		Clip-in Marker with Earth Symbol ■	
AB1SR6	AB1SAI		AB1RT	
				
Sold in Lots of 200	Sold in Lots of 500		Sold in Lots of 500	
Unit Weight: 0.6 g	Unit Weight: 0.3 g (AB1SA1, SA2) 0.4 g (AB1SA3)		Unit Weight: 0.3 g	
	Size	Unit	Size	Unit
	mm	Reference	mm	Reference
Holder for up to 6 AB1R or G markers	4.5x8.3	AB1SA1	4.5x8.3	AB1RT
	4.5x14	AB1SA2	—	—
	4.5x19	AB1SA3	—	—

- ▲ Can also be used on other Telemecanique products such as GV1 thermal-magnetic circuit breakers, modular contractors, "D" range contactors, "K" range contactors, etc.
- Black on white background



# IEC Type Industrial Control Relays; TeSys D-Line, K-Line, and SK-Line TeSys and K-Line Relay Protective Treatment

---

In order to make the correct choice of protective treatment, two points should be remembered:

1. The prevailing climate of the country is never the only criterion.
2. Only the ambient conditions in the immediate vicinity of the equipment need be considered.

---

## TH Treatment — Standard Treatment

---

The TeSys and K-Line relay are TH treated as standard, and because of this can be used in particularly severe conditions such as:

- hot and humid atmospheres with prevailing heavy condensation,
- dripping water and fungi.

Insulating parts use plastic materials which resist attack from insects (termites, beetles...). These qualities have led to this treatment being called Tropical Finish.

---

## Characteristics

---

Steel parts are usually chrome galvanized or chrome galvanized or chrome cadmium plated; when the item has a mechanical function it can also be painted.

Parts with an insulating function are manufactured in a material with improved leakage resistance, (standards IEC 112, NFC 26-220, DIN 53480) and are treated to be fungus resistant.

Metallic enclosures are given a baked enamel finish, applied over a protective phosphatizing coat.

TH treatment is suitable for the most severe climatic conditions and conforms to the following standards:

UTE Publication C 63-100 (treatment II)  
12 successive humid heat cycles at:

- +40°C / 104°F temperature and 95% relative humidity
- +48 hours of salt spray.

Standards DIN 50015-50016, alternating environmental chamber conditions:

- +23°C / 73°F temperature and 83% relative humidity
- +40°C / 104°F temperature and 92% relative humidity.

---

## Utilization Limits

---

TH treatment can be used in the following temperature and humidity conditions:  
Temperature from +20 to +40°C / +68 to +104°F with a relative humidity which can reach 95%.

---



# IEC Type Industrial Control Relays; TeSys D-Line, K-Line, and SK-Line Long Distance Control Data

## Voltage Drop Caused by the Inrush Current

When the operating coil of a relay is energized, the inrush current produces a voltage drop in the control supply cable caused by the resistance of the conductors, which can adversely affect closing of the relay.

An excessive voltage drop in the control supply cables (both a.c. and d.c.) can lead to non closure of the relay poles or even destruction of the coil due to overheating.

This phenomenon is aggravated by:

- a long line,
- a low control circuit voltage,
- a cable with a small cross-sectional area (c.s.a.)
- a high inrush power drawn by the coil.

The maximum length of cable, depending on the control voltage, the inrush power and the conductor c.s.a. is indicated in the graphs below.

### Remedial Action

To reduce the voltage drop at switch-on:

- increase the conductor c.s.a.
- use a higher control circuit voltage
- use an intermediate control relay.

### Selection of Conductor c.s.a.

These graphs are for a maximum line voltage drop of 5%. They give a direct indication of the copper conductor c.s.a. to be used for the control circuit cable, depending on its length, the inrush power drawn by the relay coil and the control circuit voltage (see example page 25).

Total resistance of the 2 conductors of the control circuit in  $\Omega$  (1)

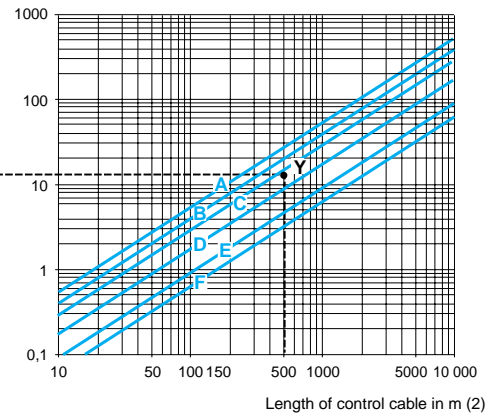
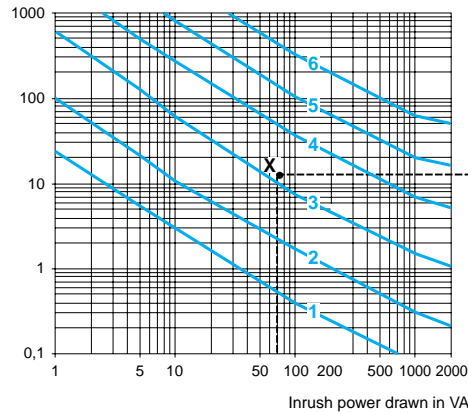

1 24 Vac	3 115 Vac	5 400 V
2 48 Vac	4 230 Vac	6 690 Vac

### Size of Copper Wires

A # 20 AWG (0.75 mm <sup>2</sup> )	C # 16 AWG (1.5 mm <sup>2</sup> )	E # 12 AWG (4 mm <sup>2</sup> )
B # 18 AWG (1 mm <sup>2</sup> )	D # 14 AWG (2.5 mm <sup>2</sup> )	F # 10 AWG (6 mm <sup>2</sup> )

Total resistance of the 2 conductors of the control circuit in  $\Omega$  (1)

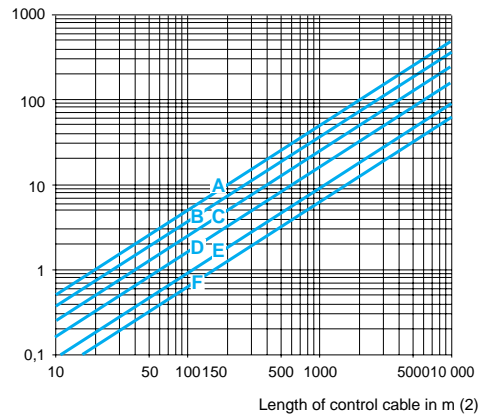
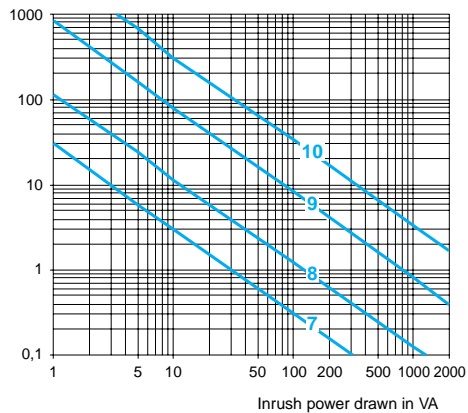

7 24 Vdc	9 125 Vdc
8 48 Vdc	10c 250 Vdc

### Size of Copper Wires

A # 20 AWG (0.75 mm <sup>2</sup> )	C # 16 AWG (1.5 mm <sup>2</sup> )	E # 12 AWG (4 mm <sup>2</sup> )
B # 18 AWG (1 mm <sup>2</sup> )	D # 14 AWG (2.5 mm <sup>2</sup> )	F # 10 AWG (6 mm <sup>2</sup> )

(1) For 3-wire control, the current only flows in 2 of the conductors.

(2) This is the length of the cable comprising 2 or 3 conductors (Distance between the relay and the control device).





# IEC Type Industrial Control Relays; TeSys D-Line, K-Line, and SK-Line Long Distance Control Data

## Voltage Drop Caused by the Inrush Current (continued)

What cable c.s.a. is required for the control circuit of an CAD50G7 relay, operated from a distance of 500 meters.

CAD50G7, voltage 120 V, 60 Hz: inrush power: 70 VA.

On the left-hand graph on page 24, point X is at the intersection of the vertical line corresponding to 70 VA and the a 120 V (estimated) voltage curve.

On the right-hand graph on page 24 point Y is at the intersection of the vertical line corresponding to 500 m and the horizontal line passing through point X.

Use the conductor c.s.a. indicated by the curve which passes through point Y, between # 14 and # 16 AWG.

If point Y lies between two c.s.a. curves, choose the larger of the c.s.a. values. In this case # 14 AWG.

## Calculating the maximum cable length

The maximum permissible length for acceptable line voltage drop is calculated by the formula:

$$L = \frac{U^2}{SA} \cdot s \cdot K.$$

Where:

L: distance between the contactor and the control device in m, (length of the cable),

U: supply voltage in V,

SA: apparent inrush power drawn by the coil in VA, (Vac) or W (Vdc)

s: conductor c.s.a. in mm<sup>2</sup>,

K: factor given in the table below.

<b>a.c. supply</b>	SA in VA	20	40	100	150	200
	K	1.38	1.5	1.8	2	2.15
<b>d.c. supply</b>	Irrespective of the inrush power SA, expressed in W					
	K = 1.38					



# IEC Type Industrial Control Relays; TeSys D-Line, K-Line, and SK-Line Long Distance Control Data

## Residual Current in the Coil Due to Cable Capacitance

When the control contact of a relay is opened the cable capacitance is effectively in series with the coil of the electromagnet. This capacitance can cause a residual current to be maintained in the coil, with the risk that the relay will remain closed.

**This only applies to relays operating on an a.c. supply.**

This phenomenon is aggravated by:

- a long line length between the coil control contact and the relay, or between the coil control contact and the power supply,
- a high control circuit voltage,
- a low coil consumption, sealed,
- a low value of relay drop-out voltage.

The maximum control cable length, according to the relay coil supply voltage, is indicated in the graph on page 27.

### Remedial action

Various solutions can be adopted to avoid the risk of the contactor remaining closed due to cable capacitance:

- use a d.c. control voltage, or,
- add a rectifier, connected as shown in the scheme below, but retaining an a.c. operating coil: in this way, rectified a.c. current flows in the control circuit cable.

When calculating the maximum cable length, take the resistance of the conductors into account.

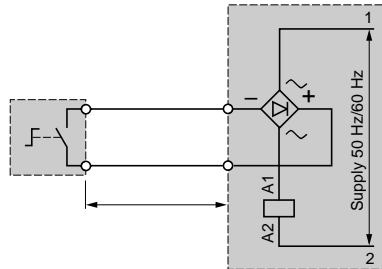

- Connect a resistor in parallel with the contactor coil (1).

Value of the resistance:

$$R\Omega = \frac{1}{10^{-3} C(\mu F)} \quad (C \text{ capacitance of the control cable})$$

Power to be dissipated

$$PW = \frac{U^2}{R}$$

- (1) To avoid increasing the voltage drop due to inrush current, this resistor must be brought into operation after the relay has closed by using a N/O contact.



# IEC Type Industrial Control Relays; TeSys D-Line, K-Line, and SK-Line Long Distance Control Data

## Residual Current in the Coil due to Cable Capacitance (continued)

These graphs are for a capacitance, between conductors, of 0.2 μF/km. They make it possible to determine whether there is a risk of the contactor remaining closed due to the power drawn by the coil when sealed and the control circuit voltage, according to the length of the control cable.

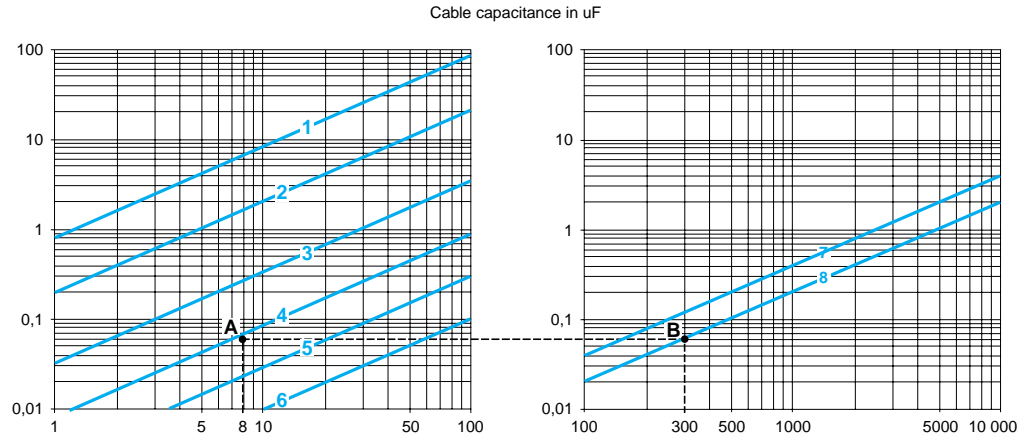

### Power drawn, sealed in VA

1 24 Vac	4 230 Vac
2 48 Vac	5 400 Vac
3 115 Vac	6 690 Vac

### Length of control cable in m

7 3-wire control
8 2-wire control

In the zones below the straight lines for 3-wire and 2-wire control respectively, there is a risk of the relay remaining closed.

### Examples

What is the maximum length for the control cable of a CAD50 relay, operating on 230 V, with 2-wire control?

- CAD50 relay, voltage 230 V, 60 Hz: power sealed 8 VA.

On the left-hand graph, point A is at the intersection of the vertical line for 8 VA with the a 230 V voltage curve.

On the right-hand graph, point B is at the intersection of the horizontal line with the 2-wire control curve.

The maximum cable length is therefore 300 m.

In the same example, with a 600 m cable, the point lies in the risk zone. A resistor must therefore be connected in parallel with the relay coil.

Using right hand table above, find 600 meter along the bottom and follow up to line B (2 wire control) and then to the left to obtain C value.

Value of this resistance:

$$R = \frac{1}{10^{-3} \times C} = \frac{1}{10^{-3} \times 0.12} = 8.3 \text{ k}\Omega$$

Power to be dissipated:

$$P = \frac{U^2}{R} = \frac{(230)^2}{8300} = (6.5) \text{ W}$$

Alternative solution: use a d.c. control supply.

### Calculating the Cable Length

The maximum permitted length of control cable to avoid the effects of capacitance is calculated using the formula:

$$L = 455 \times \frac{S}{U^2 \times Co}$$

L: distance between the contactor and the control device in km (length of the cable),

S: apparent power, sealed, in VA,

U: control voltage in V,

Co: cable capacitance in μF/km. (to be supplied by wire manufacturer for type of wire used)



Square D Company  
8001 Highway 64 East  
Knightdale, NC 27545  
1-888-SquareD  
(1-888-778-2733)  
[www.SquareD.com](http://www.SquareD.com)

Schneider Canada Inc.  
19 Waterman Avenue,  
M4B 1 Y2  
Toronto, Ontario  
1-800-565-6699  
[www.schneider-electric.ca](http://www.schneider-electric.ca)

Catalog No. 8501CT0101 April 2001 © 2001 Schneider Electric All Rights Reserved