

Switches, Four Way  
20A, 120-277V AC  
Specification Grade Commercial Switch

# HUBBELL

## Features

- Thread cleaning captive mounting screw
- Abuse resistant nylon toggle
- Steel, zinc plated bridge is corrosion resistant

## Ordering Information

Description	Toggle Color	UPC	Catalog Number
Toggle, back and side wired	Gray	783585154329	CSB420GY

## Listings

UL Listed  
CSA Certified  
Fed. Spec. W-S-896



## Specifications

Top Material	Thermoplastic, Gray
Base Material	Thermoplastic, Black
Toggle Material	Nylon
Contacts	Silver Alloy
Terminal Screws	Brass
Auto Grounding Mounting Bridge	Zinc Plated Steel
Ground Screw	Brass (Green)

## Performance

### Electrical

Dielectric Voltage	Withstands 1500V AC minimum for 1 minute
Max. Continuous Current	20A
Max. Working Voltage	277V AC
Overload	Minimum 4.8 times rated current for 100 cycles
Temperature Rise	30°C maximum at rated current

### Mechanical

Terminal Accommodations #14 AWG min. - #10 AWG max. solid and stranded copper wire only

### Environmental

Flammability	UL 94V-2
Operating Temperature	Max. continuous: 75°C; Min. continuous: -40°C without impact

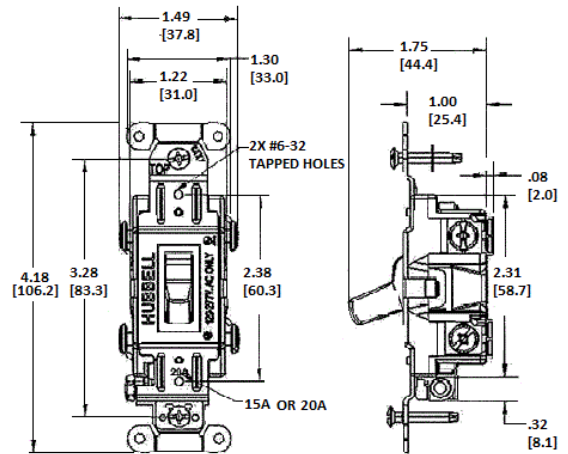

## Online Resources

Customer Use Drawing  
eCatalog

Dimensions in Inches (mm)

Hubbell Wiring Device-Kellems • Hubbell Incorporated (Delaware) • 40 Waterview Drive • Shelton, CT 06484

Phone (800) 288-6000 • Fax (800) 255-1031 • Specifications subject to change without notice.

