

Ceiling Fan Boxes and Accessories

Extra Heavy-Duty New-Work Bar Hangers

Ceiling Fan and Light Fixture Bar Hangers

This innovative extruded-aluminum bar hanger was designed for strength. It is UL Listed for up to 70 lbs. for fan support and an industry-leading 200 lbs. for fixture support

- Gold end plates easily identify the hanger as meeting UL and NEC® requirements for fan support
- Screwed-on end plates are consistently strong and avoid unsightly welds
- End plates feature temporary fixing spikes for hands-free installation
- Expandable for joists spaced from 16 to 24 inches



56111CFB-BHL



54151CFB-BHL



4070CFB-BHL



CFB-BHL



| CAT. NO. | CAPACITY CU. IN. | DESCRIPTION | MAX. REC. LOAD | | NEW/OLD WORK | STD. CTN. |
|--------------|---------------------|--|-------------------|----------|-----------------|-----------|
| | | | FAN | FIXTURE | | |
| 56111CFB-BHL | 6.0 | New-work bar hanger with 1/2" pan-type ceiling fan box with 3 x 1/2" KOs and non-metallic sheathed cable connector | 70 lbs. | 200 lbs. | New | 10 |
| 54151CFB-BHL | 15.8 | New-work bar hanger with 1 1/2" deep ceiling fan box with 3 x 1/2" KOs and clamps for non-metallic sheathed cable | 70 lbs. | 200 lbs. | New | 10 |
| 4070CFB-BHL | 21.5 | New-work bar hanger with non-metallic ceiling fan box with clamps for non-metallic sheathed cable | 35 lbs. | 50 lbs. | New | 10 |
| CFB-BHL | * | New-work bar hanger without outlet box. Mounting bracket for outlet box included | — | * | New | 10 |

* Dependent on box used.

NEC and National Electrical Code are registered trademarks of the National Fire Protection Association, Inc.

Square Boxes and Accessories

Easy to identify and install!

Fire Alarm Boxes and Fittings

Steel City® Fire Alarm Boxes and Fittings can meet all of your visual identification requirements for fire alarm systems — and make installation and upgrades faster and easier than ever before! Available in a variety of sizes to accommodate new or old work configurations, these boxes are simple to install with high-quality Thomas & Betts fittings. Plus, the bright red finish eliminates time-consuming painting of existing fixtures and provides long-lasting identification in even the harshest environments.



52171-1234RD



72171-1234RD



52171-EXTRD



52-C-1RD



52151-1234RD



52171-CV-1234RD



52171-EXTOWRD



53171-1234RD

Fire Alarm Boxes



| CAT. NO. | DESCRIPTION | EARS | BRACKETS | EACH SIDE CONDUIT | EACH END CONDUIT | BOTTOM CONDUIT | CU. IN. | STD. CAPACITY | CTN. |
|-----------------|---|------|----------|-------------------|-------------------|-------------------|---------|---------------|------|
| 52171-1234RD | 2½"-deep 4"-square red box | — | — | 2½", 1½" & ¾"E | 2½", 1½" & ¾"E | 3½", 2½" & ¾"E | 30.3 | 50 | |
| 52151-1234RD | 1½"-deep 4"-square drawn red box | — | — | 2½", 1¼" | 2½", 1¼" | 3½", 2¾" | 21.0 | 50 | |
| 72171-1234RD | 2½"-deep 4⅞" red box | — | — | 3½" & ¾"E | 3½" & ¾"E | 3½", 2½" & ¾"E | 42.0 | 20 | |
| 52171-CV-1234RD | 2½"-deep 4"-square red box with CV bracket | — | CV | 2½", 1½" & ¾"E | 2½", 1½" & ¾"E | 3½", 2½" & ¾"E | 30.3 | 50 | |
| 52171-EXTRD | 2½"-deep 4"-square red box with ext. ring | — | — | 4½", 2½" & ¾"E | 4½", 2½" & ¾"E | 3½", 2½" & ¾"E | 60.6 | 25 | |
| 52171-EXTOWRD | 2½"-deep 4"-square red box with ext. ring and old work ears | Yes | — | 4½", 2½" & ¾"E | 4½", 2½" & ¾"E | 3½", 2½" & ¾"E | 60.6 | 25 | |
| 52 C 1RD | Flat 4"-square red cover | — | — | — | — | — | — | — | 100 |
| 53171-1234RD | 2½"-deep 4"-square red extension ring | — | — | 2½", 1½" & ¾"E | 2½", 1½" & ¾"E | — | 30.3 | 25 | |
| 521911234RD | 3½"-deep 4"-square red box | — | — | 4 x ½" & ¾" Combo | 2 x ½" & ¾" Combo | 4 x ½" & ¾" Combo | 46 | 24 | |
| 521911234CVRD | 3½"-deep 4"-square red box w/side mounting bracket | — | CV | 4 x ½" & ¾" Combo | 2 x ½" & ¾" Combo | 4 x ½" & ¾" Combo | 46 | 10 | |

Fire Alarm Fittings



| CAT. NO. | DESCRIPTION | STD. CTN. |
|-----------|--|-----------|
| TC121A-FA | ½" Red Steel EMT Set Screw Connector | 50 |
| TC122A-FA | ¾" Red Steel EMT Set Screw Connector | 50 |
| TC123A-FA | 1" Red Steel EMT Set Screw Connector | 25 |
| TC721A-FA | ½" Red Insulated Steel EMT Set Screw Connector | 50 |
| TC722A-FA | ¾" Red Insulated Steel EMT Set Screw Connector | 50 |
| TC723A-FA | 1" Red Insulated Steel EMT Set Screw Connector | 25 |
| TK121A-FA | ½" Red Steel EMT Set Screw Coupling | 50 |
| TK122A-FA | ¾" Red Steel EMT Set Screw Coupling | 50 |
| TK123A-FA | 1" Red Steel EMT Set Screw Coupling | 25 |



TK122A-FA



TK121A-FA



TC122A-FA



TC121A-FA

Square Boxes and Accessories

4" Square Old-Work Box with Swing Ears

| CAT. NO. | DESCRIPTION | STD. CTN. |
|--------------|--|-----------------|
| 52171-OW | Metallic 4"-Sq. x 2½"D Old-Work Box with factory-mounted swing ears | 25 |
| OW SWING EAR | Swing Ears only (for field installation) with self-threading screws | 50 (25 pair) |



52171-OW



OW Swing Ears

4" Square Boxes

| CAT. NO. | DEPTH (IN.) | CU. IN. CAPACITY | CLAMPS | BRKTS. | KNOCKOUTS (IN.) | | | STD. CTN. |
|---|-------------|------------------|--------|--------|------------------|-----------------|----------------|-----------|
| | | | | | EA. SIDE CONDUIT | EA. END CONDUIT | BOTTOM CONDUIT | |
| With Non-Metallic Sheathed Cable Clamps | | | | | | | | |
| 52151 N | 1½ | 21.0 | C-5 | — | 2-½, 1-½, ¾E | 2 | 1-½ | 50 |
| 52151 MS N* | 1½ | 21.0 | C-5 | MS | 2-½, 1-½, ¾E | 2 | 1-½ | 25 |
| 52151 BN* | 1½ | 21.0 | C-5 | B | 2-½, 1-½, ¾E | 2 | 1-½ | 25 |
| 52151 VN* | 1½ | 21.0 | C-5 | SV | 2-½, 1-½, ¾E | 2 | 1-½ | 25 |
| 52151 CVN* | 1½ | 21.0 | C-5 | CV | 2-½, 1-½, ¾E | 2 | 1-½ | 25 |
| 52151CVNP* | 1½ | 21.0 | C-5 | CV | 2-½, 1-½, ¾E | 2 | 1-½ | 25 |
| 52171 N | 2½ | 30.3 | C-5 | — | 2-½, 1-½, ¾E | 2 | 1-½ | 25 |
| 52171-VN* | 2½ | 30.3 | C-5 | SV | 2-½, 1-½, ¾E | 2 | 1-½ | 25 |
| With Conduit KOs | | | | | | | | |
| 52141-1/2 | 1¼ | 18.0 | — | — | 2-½, 1-¼, ¾E | 3-½, 1-¼, ¾E | 5-½ | 50 |
| 52151 1/2 | 1½ | 21.0 | — | — | 2-½, 1-¼, ¾E | 2-¾, 1-¼, ¾E | 3-½, 2-¾ | 50 |
| 52151-3/4 | 1½ | 21.0 | — | — | 2-½, 1-¼, ¾E | 2-¾, 1-¼, ¾E | 3-½, 2-¾ | 50 |
| 52151 1/2 3/4 | 1½ | 21.0 | — | — | 2-½, 1-¼, ¾E | 2-½, 1-¼, ¾E | 3-½, 2-¾ | 50 |
| 521511234P | 1½ | 21.0 | — | — | 2-½, 1-¼, ¾E | 2-½, 1-¼, ¾E | 3-½, 2-¾ | 50 |
| 52151-3/4-W | 1½ | 21.0 | — | — | 2-½, 1-¼, ¾E | 2-¾, 1-¼, ¾E | 3-½, 2-¾ | 50 |
| 52151B1234* | 1½ | 21.0 | — | B | 2-½, 1-½, ¾E | 2-½, 1-¼, ¾E | 3-½, 2-½ | 25 |
| 52151-1/2 & 3/4-EW | 1½ | 21.0 | — | — | 2-½, 1-½, ¾E | 2-½, 1-¼, ¾E | 3-½, 2-½ | 50 |
| 521511234EWGB (Ground bump) | 1½ | 21.0 | — | — | 2-½, 1-½, ¾E | 2-½, 1-¼, ¾E | 2-½, 2-½ | 50 |
| 521511234EWGBP (Ground bump with 10½" ground wire) | 1½ | 21.0 | — | — | 2-½, 1-½, ¾E | 2-½, 1-¼, ¾E | 2-½, 2-½ | 50 |

* All Bracketed boxes come complete with eccentric knockouts.
Per UL 514A, suitable for use without a bonding jumper in circuits above or below 250 volts. Pigtail wire is #12 AWG insulated, 10½" long.

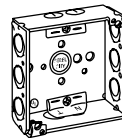

52151 N

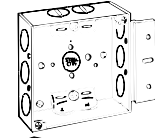

52151 MS N*
MS bracket for
1½", 2½", 3½", 4"

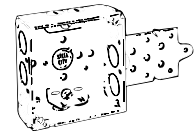

52151 BN*
B bracket
mounted flush

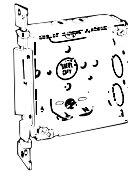

52151 VN*
SV bracket
mounted flush

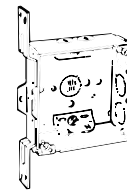

52151 CVN*
CV bracket
mounted flush

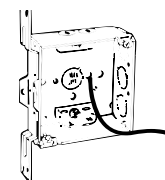

52151 CVNP



52171 N

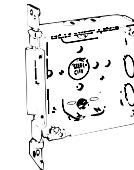

52171-VN*
SV bracket
mounted flush



52141-1/2



52151 1/2



52151-3/4



52151 1/2 3/4

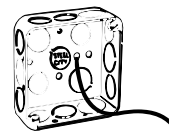

521511234P

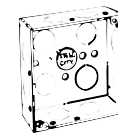

52151-3/4-W

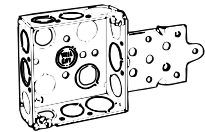

52151B1234
B Bracket mounted flush



52151-1/2 & 3/4-EW

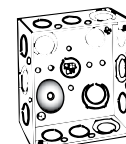

521511234EWGB



521511234EWGBP

Square Boxes and Accessories

4" Square Boxes (continued)

| CAT. NO. | DEPTH (IN.) | CU. IN. CAPACITY | CLAMPS | BRKTS. | KNOCKOUTS (IN.) | | | STD. CTN. |
|--|-------------|------------------|--------|--------|------------------|-----------------|----------------|-----------|
| | | | | | EA. SIDE CONDUIT | EA. END CONDUIT | BOTTOM CONDUIT | |
| <i>With Conduit KOs (continued)</i> | | | | | | | | |
| 521511234EWP* | 1½ | 21.0 | — | — | 2-½, ¼E | 2-½, ¼E | 3-½, ¼E | 50 |
| 52151 MS 1/2 & 3/4* | 1½ | 21.0 | — | MS | 2-½, ¼E | 2-½, ¼E | 3-½, ¼E | 25 |
| 52151-V-1/2 & 3/4* | 1½ | 21.0 | — | SV | 2-½, ¼E | 2-½, ¼E | 3-½, ¼E | 25 |
| 52151 CV 3/4* | 1½ | 21.0 | — | CV | 2-¾ | 2-¾ | 3-½ | 25 |
| 52151 CV 1/2 3/4* | 1½ | 21.0 | — | CV | 2-½, ¼E | 2-¾, ¼E | 3-½, ¼E | 25 |
| 52151DV12* | 1½ | 21.0 | — | DV | 2-½, ¼E | 3-½, ¼E | 3-½, ¼E | 25 |
| 521711234E | 2½ | 30.3 | — | — | 2-½, ¼E | 2-½, ¼E | 3-½, ¼E | 50 |
| 521711234EP (With 10½" ground wire) | 2½ | 30.3 | — | — | 2-½, ¼E | 2-½, ¼E | 2-½, ¼E | 50 |
| 52171 MS 1/2 3/4* | 2½ | 30.3 | — | MS | 2-½, ¼E | 2-½, ¼E | 3-½, ¼E | 25 |
| 52171MSP* (With 10½" ground wire) | 2½ | 30.3 | — | MS | 2-½, ¼E | 2-½, ¼E | 3-½, ¼E | 25 |
| 52171 3/4 | 2½ | 30.03 | — | — | 2-¾ | 2-¾ | 3-½, 2-¾ | 50 |
| 52171 1 | 2½ | 30.03 | — | — | 2-1 | 2-1 | 3-½, 2-¾ | 50 |
| 52171 V 1/2 & 3/4* | 2½ | 30.03 | — | SV | 2-½, ¼E | 2-½, ¼E | 3-½, ¼E | 25 |
| 52171-CV-1/2 & 3/4* | 2½ | 30.03 | — | CV | 2-½, ¼E | 2-½, ¼E | 3-½, ¼E | 25 |
| 52171-EW-SSX* | 2½ | 30.03 | — | SSX | — | — | — | — |
| 521711234EP* | 2½ | 30.03 | — | v | 2-½, ¼E | 2-½, ¼E | 3-½, ¼E | 25 |
| 52171-B-1/2 & 3/4 | 2½ | 30.03 | — | — | 2-½, ¼E | 2-½, ¼E | 3-½, ¼E | 25 |

* All bracketed boxes come complete with eccentric knockouts.
Per UL514A, suitable for use without a bonding jumper in circuits above or below 250 volts. Pigtail wire is #12 AWG insulated, 10½" long.

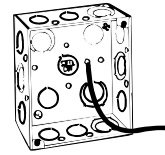

521511234EWP

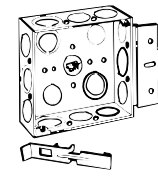

52151 MS 1/2 & 3/4
For use on 1½", 2½", 3½", 4" studs

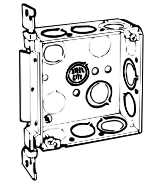

52151-V-1/2 & 3/4
SV Bracket mounted flush

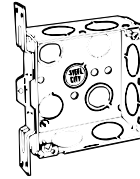

52151 CV 3/4
CV Bracket mounted flush



52151 CV 1/2 3/4
CV Bracket mounted flush

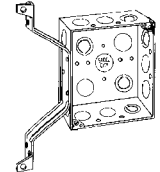

52151DV1/2
DV Bracket provides offset



521711234E



521711234EP



52171 MS 1/2 3/4*
MS bracket for 1½", 2½", 3½", 4", 6" metal studs

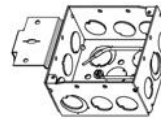

52171MSP

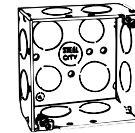

52171 3/4



52171 1



52171 V 1/2 & 3/4
SV bracket mounted flush



52171-CV-1/2 & 3/4
CV bracket mounted flush

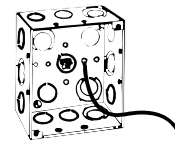

521711234EP

| CAT. NO. | DESCRIPTION | EARS | BRACKETS | EACH SIDE KO | EACH END KO | BOTTOM KO | CU. IN. CAPACITY | STD. CTN. |
|-------------|--|------|----------|-------------------|-------------------|-------------------|------------------|-----------|
| 521911234 | 3½"-deep 4"-square red box | — | — | 4 x ½" & ¾" Combo | 2 x ½" & ¾" Combo | 4 x ½" & ¾" Combo | 46 | 24 |
| 521911234CV | 3½"-deep 4"-square red box w/side mounting bracket | — | CV | 4 x ½" & ¾" Combo | 2 x ½" & ¾" Combo | 4 x ½" & ¾" Combo | 46 | 10 |

Square Boxes and Accessories

4" Square Boxes (continued)

| CAT. NO. | DEPTH (IN.) | CU. IN. CAPACITY | CLAMPS | BRKTS. | KNOCKOUTS (IN.) | | | |
|--|-------------|------------------|--------|--------|------------------|-----------------|----------------|-------------------|
| | | | | | EA. SIDE CONDUIT | EA. END CONDUIT | BOTTOM CONDUIT | STD. CONDUIT CTN. |
| With Armored Cable/Metal-Clad Clamps | | | | | | | | |
| 52151 X | 1¼ | 21.0 | C-3 | — | 2-½, 1-½, ¾E | 2 | 1-½ | 50 |
| 52151XP | 1¼ | 21.0 | C-3 | — | 2-½, 1-½, ¾E | 2 | 1-½ | 50 |
| 52151 BX* | 1¼ | 21.0 | C-3 | B | 2-½, 1-½, ¾E | 2 | 1-½ | 25 |
| 52151 VX* | 1¼ | 21.0 | C-3 | SV | 2-½, 1-½, ¾E | 2 | 1-½ | 25 |
| 52151 CVX* | 1¼ | 21.0 | C-3 | CV | 2-½, 1-½, ¾E | 2 | 1-½ | 25 |
| 52151 MS X* | 1¼ | 21.0 | C-3 | MS | 2-½, 1-½, ¾E | 2 | 1-½ | 25 |
| For Armored Cable and Metal-Clad Cable Clamps | | | | | | | | |
| 52171 X* | 2½ | 30.3 | C-3 | — | 2-½, 1-½, ¾E | 2 | 1-½ | 25 |
| 52171 MSX* | 2½ | 30.3 | C-3 | MS | 2-½, 1-½, ¾E | 2 | 1-½ | 25 |
| 52171MSXP (With 10½" ground wire) | 2½ | 30.3 | C-3 | MS | 2-½, 1-½, ¾E | 2 | 1-½ | 25 |
| 52171-CVX* | 2½ | 30.3 | C-3 | CV-2 | ½-¾ | — | — | 25 |

* All bracketed boxes come complete with eccentric knockouts. Per UL514A, suitable for use without a bonding jumper in circuits above or below 250 volts. Pigtail wire is #12 AWG insulated, 10½" long. All 52171 series boxes have a raised ground bump.



52151 X

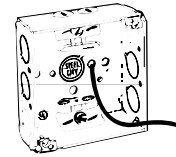

52151XP

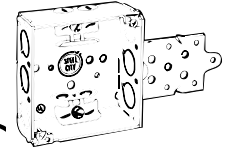

52151 BX*
B bracket
mounted flush

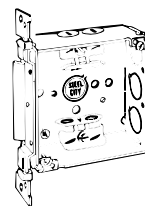

52151 VX*
SV bracket
mounted flush

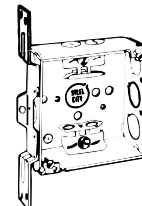

52151 CVX*
CV bracket
mounted flush

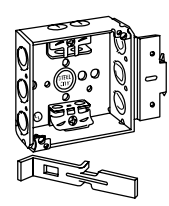

52151 MS X*
MS bracket for 1½",
2½", 3¾", 4" metal studs

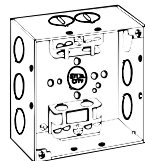

52171 X

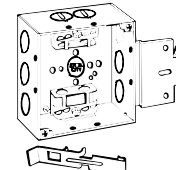

52171 MSX*
MS bracket for 1½",
2½", 3¾", 4" metal studs

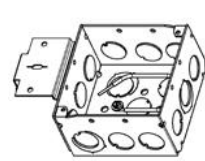

52171MSXP*

| CAT. NO. | DESCRIPTION | CLAMPS | EACH SIDE CONDUIT | EACH END CONDUIT | BOTTOM CONDUIT | CU. IN. CAPACITY | STD. PACK. |
|--------------|------------------------------------|--------|-------------------|------------------|----------------|------------------|------------|
| 52171-EW-SSX | 2½"-deep with conduit KOs | — | 1½", 1½" & ¾"E | 2½", 1½" & ¾"E | 2½", 2½" & ¾"E | 30 | 20 |
| 52151-EF-SSX | 1½"-deep with conduit KOs | — | 1½", 1½" & ¾"E | 2½", 1½" & ¾"E | 2½", 2½" & ¾"E | 21 | 20 |
| 52171-X-SSX | 2½"-deep with armored cable clamps | C3 | 1½", 1½" & ¾"E | 2 Cable | 1½" | 30 | 20 |
| 52151-X-SSX | 1½"-deep with armored cable clamps | C3 | 1½", 1½" & ¾"E | 2 Cable | 1½" | 21 | 20 |
| CXLESSX | 3½"-deep with armored cable clamps | C3 | 2½" | 1½" & 2 Cable | 1½" | 15 | 20 |

Vapor Tite Boxes

- All K.O.'s pressed flush but still easy to remove
- No holes anywhere
- Top edge of boxes are flush at ears so gasket seals out all air

| CAT. NO. | DESCRIPTION | DEPTH | STD. PKG. |
|-----------|---|-------|-----------|
| 52151-SVT | 4" Sq. Box, ½" and ¾" K.O. Side and Bottom | 1½" | 50 |
| 52C1-VT | 4" Sq. Blank Cover with Gasket | Flat | 50 |
| 52171-SVT | 4" Sq. Box, ½" and ¾" K.O. Side and Bottom | 2½" | 25 |
| 72C1-VT | 4½" Sq. Blank Cover with Gasket | Flat | 50 |
| 72171-SVT | 4½" Sq. Box, ½" and ¾" K.O. Side and Bottom | 2½" | 25 |
| 54151-VT | 4" Sq. Box, ½" K.O. Side and Bottom | 1½" | 50 |
| 54C1-VT | 4" Oct. and Round Box Blank Cover | Flat | 50 |

Square Boxes and Accessories

4" Square Boxes

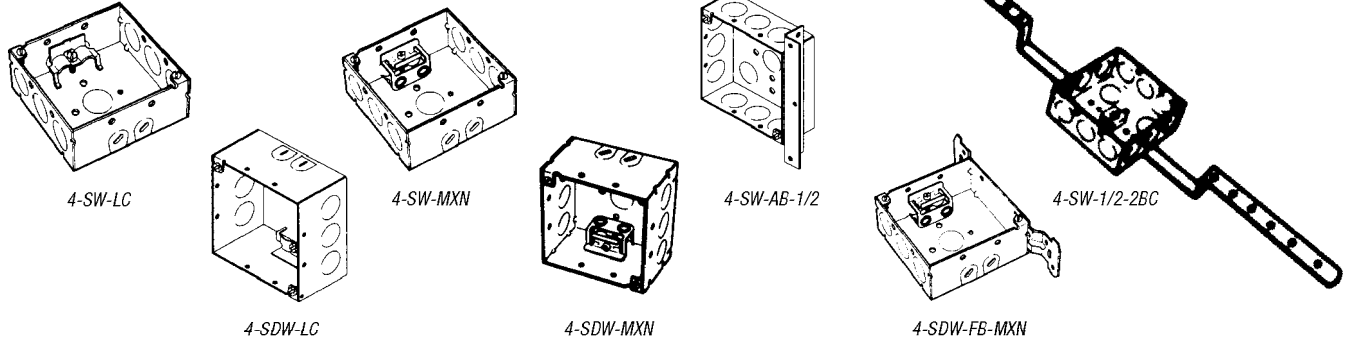

| CAT. NO. | DEPTH (IN.) | CU. IN. CAPACITY | DESCRIPTION | CONSTRUCTION TYPE | STD. CTN. |
|--------------|-------------|------------------|---|-------------------|-----------|
| 4-SW-LC | 1½ | 21.0 | For Non-Metallic Sheathed Cable Two Loom KOs in each of two opposite sides, three ½" KOs in other two sides and one ½" KO in bottom. Two Loom clamps for use on non-metallic sheathed cable with 10/32 deep-slotted screws assembled* | Welded | 50 |
| 4-SW-MXN | 1½ | 21.0 | For Metal-Clad Cable Two Loom KOs in each of two opposite sides, three ½" KOs in other two sides and one ½" KO in bottom. Two MXN clamps for MC, AC/BX and non-metallic sheathed cable (NM) included with 10/32 deep-slotted screws. Clamps are UL Listed for use with cable sizes 14/2 through 10/3 with ground* | Welded | 50 |
| 4-SW-AB-1/2 | 1½ | 21.0 | Three KOs in each of three sides, angle bracket on other side, and five ½" KOs in bottom. Angle bracket offset ¾" from top of box* | Welded | 50 |
| 4-SW-1/2-2BC | 1½ | 21.0 | Three ½" KOs in each side and four ½" KOs in bottom. Mounted with clip on 2-BC bar hanger. Hanger is offset correct depth to set box flush with ceiling joist* | Welded | 25 |
| 4-SDW-LC | 2½ | 30.3 | For Non-Metallic Sheathed Cable Two Loom KOs in each of two opposite sides, three ½" KOs in other two sides and one ½" KO in bottom. Two Loom clamps for use on non-metallic sheathed cable with 10/32 deep-slotted screws assembled* | Welded | 25 |
| 4-SDW-MXN | 2½ | 30.3 | For Metal-Clad Cable Two Loom KOs in each of two opposite sides, three ½" KOs in other two sides and one ½" KO in bottom. Two MXN clamps for MC, AC/BX and non-metallic sheathed cable (NM) included with 10/32 deep-slotted screws. Clamps are UL Listed for use with cable sizes 14/2 through 10/3 with ground* | Welded | 25 |
| 4-SDW-FB-MXN | 2½ | 30.3 | For Metal-Clad Cable Two Loom KOs in each of two opposite sides, three ½" KOs in side opposite flat bracket and one ½" KO in bottom. Two MXN clamps for MC, AC/BX and non-metallic sheathed cable (NM) included with 10/32 deep-slotted screws. Clamps are UL Listed for use with cable sizes 14/2 through 10/3 with ground* | Welded | 25 |

*Uses Steel City® 4" square extension rings and 400 series rings and covers.

4" Square Thru-Wall Box



| CAT. NO. | DEPTH (IN.) | CU. IN. CAPACITY | KNOCKOUT (IN.) | | | STD. CTN. |
|-------------------------|-------------|------------------|------------------|-----------------|--|-----------|
| | | | EA. SIDE CONDUIT | EA. END CONDUIT | | |
| With Conduit KOs | | | | | | |
| X1-1/2 & 3/4 | 1½ | 21.0 | 2-½, 1-¾ | 2-½, 1-¾ | | 25 |

4" Square Two-Device Boxes

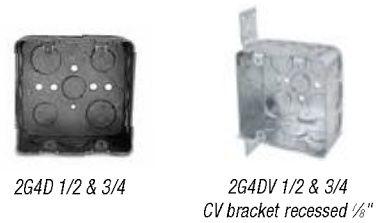

| CAT. NO. | DEPTH (IN.) | CU. IN. CAPACITY | BRACKETS | KNOCKOUTS (IN.) | | | STD. CTN. |
|-------------------------|-------------|------------------|----------|------------------|-----------------|----------------|-----------|
| | | | | EA. SIDE CONDUIT | EA. END CONDUIT | BOTTOM CONDUIT | |
| With Conduit KOs | | | | | | | |
| 2G4D 1/2 & 3/4 | 2½ | 30.3 | — | 2-½, 1-¾ | 2-½, 1-¾ | 3-½, 2-¾ | 25 |
| 2G4DV 1/2 & 3/4 | 2½ | 30.3 | CV | 2-½, 1-¾ | 2-½, 1-¾ | 3-½, 2-¾ | 25 |

Square Boxes and Accessories

4" Square Box Partitions

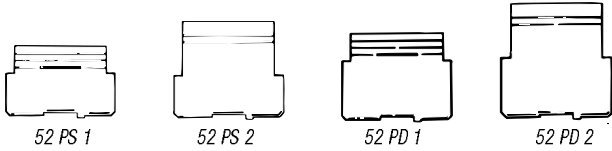

| CAT. NO. | DESCRIPTION | STD. CTN. |
|---|-----------------------------------|-----------|
| For 1½" Deep Box with Square-Cut Tile Wall Two-Device Covers | | |
| 52 PS 1 | For ½", ¾" and 1" raised covers | 25 |
| 52 PS 2 | For 1¼", 1½" and 2" raised covers | 25 |
| For 2½" Deep Box with Square-Cut Tile Wall Two-Device Covers | | |
| 52 PD 1 | For ½", ¾" and 1" raised covers | 25 |
| 52 PD 2 | For 1¼", 1½" and 2" raised covers | 25 |

4" Square Wall Rings

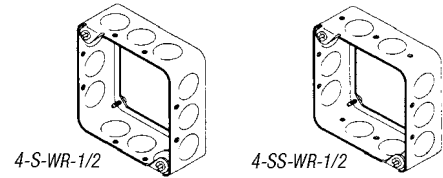

| CAT. NO. | DEPTH (IN.) | CU. IN. CAPACITY | DESCRIPTION | CONSTRUCTION TYPE | STD. CTN. |
|-------------|-------------|------------------|--|-------------------|-----------|
| 4-S-WR-1/2 | 1½ | 21.0 | Wall Ring Three ½" KOs in each side. Four 8/32 screws furnished (two in top and two in bottom)* | Drawn | 50 |
| 4-SS-WR-1/2 | 1½ | 18.0 | Wall Ring Three ½" KOs in each of two opposite sides, two ½" KOs in other two sides. Four 8/32 screws furnished (two in top and two in bottom)** | Drawn | 50 |

*For use with two Steel City® 403-0 rings for back to back devices in 2" partitions.
**For use with two Steel City® 403-0 rings for back to back devices in 1¾" partitions

4" Square Rings and Covers

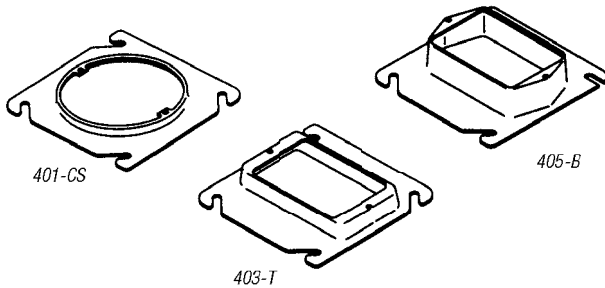

| CAT. NO. | CU. IN. CAPACITY | DESCRIPTION | STD. CTN. |
|----------|------------------|--|-----------|
| 401-CS | 1.0 | ¼" raised — 4" square Open plaster ring with ears. Ears tapped 8/32–2 ² / _{32"} on centers. Special screw lock feature in slots* | 25 |
| 403-T | 3.5 | Tile Ring, ½" raised — 4" square For single switch or receptacle. Ears tapped 8/32–2 ² / _{32"} on centers* | 50 |
| 405-B | 5.0 | ⅙" raised — 4" square For single switch or receptacle* | 25 |

*Fits any Steel City® 4" square outlet box or extension ring.

4" Square Industrial Device Covers

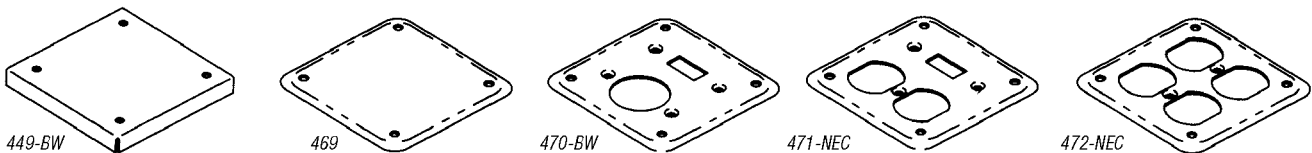

| CAT. NO. | DESCRIPTION | STD. CTN. |
|----------|--|-----------|
| 449-BW | ½" raised — 4" square Surface blank. Each cover individually packaged with the necessary screws for mounting* | 25 |
| 469 | ⅙" raised — 4" square Surface blank. Each cover individually packaged with the necessary mounting screws* | 25 |
| 470-BW | ⅙" raised — 4" square For one toggle switch and one single receptacle. Opening 1.4" diameter. Each cover individually packaged with the necessary mounting screws* | 25 |
| 471-NEC | ⅙" raised — 4" square For one toggle switch and one duplex receptacle. Each cover individually packaged with the necessary mounting screws* | 25 |
| 472-NEC | ⅙" raised — 4" square For two duplex receptacles. Each cover individually packaged with the necessary mounting screws* | 25 |

*Fits any Steel City® 4" square outlet box or extension ring.

Square Boxes and Accessories

4" Square Industrial Device Covers (continued)

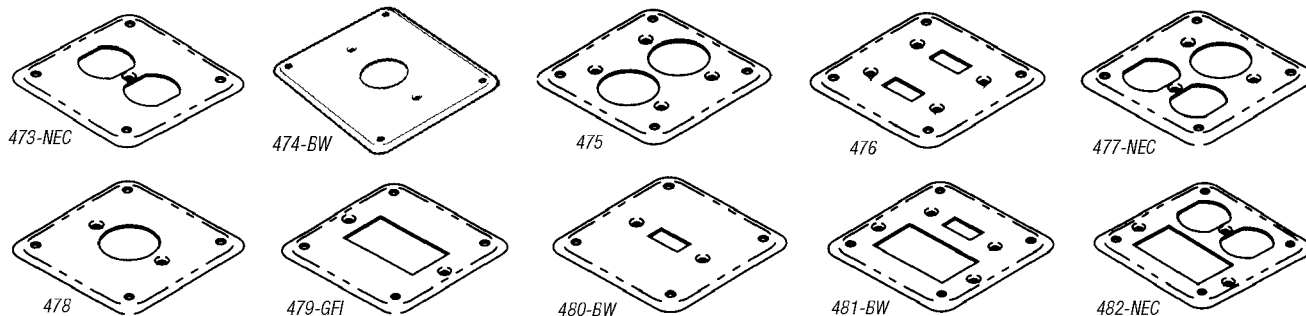

| CAT. NO. | DESCRIPTION | STD. CTN. |
|----------|--|-----------|
| 473-NEC | 1/8" raised — 4" square For one duplex receptacle in center. Each cover individually packaged with the necessary mounting screws* | 25 |
| 474-BW | 1/8" raised — 4" square For one single receptacle in center. Opening 1.4" diameter. Each cover individually packaged with the necessary mounting screws* | 25 |
| 475 | 1/8" raised — 4" square For two single receptacles. Openings 1.4" diameter. Each cover individually packaged with the necessary mounting screws* | 25 |
| 476 | 1/8" raised — 4" square For two toggle switches. Each cover individually packaged with the necessary mounting screws* | 25 |
| 477-NEC | 1/8" raised — 4" square For one duplex and one single receptacle. Opening 1.4" diameter. Each cover individually packaged with the necessary mounting screws* | 25 |
| 478 | 1/8" raised — 4" square For one four-wire twist lock receptacle in center. Opening 1.594" diameter. Each cover individually packaged with the necessary mounting screws* | 25 |
| 479-GFI | 1/8" raised — 4" square For one GFI receptacle in center. Each cover individually packaged with the necessary mounting screws* | 25 |
| 480-BW | 1/8" raised — 4" square For one toggle switch in center. Each cover individually packaged with the necessary mounting screws* | 25 |
| 481-BW | 1/8" raised — 4" square For one GFI receptacle and one toggle switch. Each cover individually packaged with the necessary mounting screws* | 25 |
| 482-NEC | 1/8" raised — 4" square For one GFI and one duplex receptacle. Each cover individually packaged with the necessary mounting screws* | 25 |

*Fits any Steel City® 4" square outlet box or extension ring.

4" Square Extension Rings



| CAT. NO. | KNOCKOUTS (IN.) | | STD. CTN. |
|--|--------------------|-----------------|-----------|
| | EA. SIDE CONDUIT | EA. END CONDUIT | |
| 1 1/2" Deep — with Conduit KOs — 21.0 Cubic Inch Capacity | | | |
| 53151 1/2 | 3-1/2 | 3-1/2 | 50 |
| 53151 3/4 | 2-3/4 | 2-3/4 | 25 |
| 53151 1/2 3/4 | 2-1/2, 1-3/4 | 2-1/2, 1-3/4 | 50 |
| 531511234UB** | 2-1/2, 1-1/2, 3/4E | 2-1/2 | 50 |
| 2 1/8" Deep — with Conduit KOs — 30.3 Cubic Inch Capacity | | | |
| 531711234* | 2-1/2, 1-1/2, 3/4E | 2-1/2, 1-3/4 | 25 |
| 53171 1 | 2-1 | 2-1 | 25 |

* Per UL 514-A, suitable for use without a bonding jumper in circuits above or below 250 volts.

** ECC, KOs on sides.

Square Boxes and Accessories

4" Square-Cut Tile Wall Covers

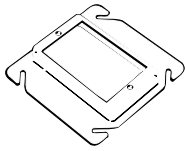

52 C 49 1/2

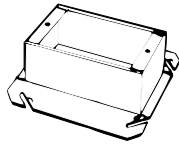

52C5011/2-25

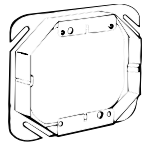

52 C 52 1/2

| CAT. NO. | RAISED (IN.) | DESCRIPTION | CU. IN. CAP. | STD. CTN. |
|----------------------------------|--------------|------------------------------|--------------|-----------|
| For Single Device — Steel | | | | |
| 52 C 49 1/2* | 1/2 | — | 3.5 | 50 |
| 52-C-49-3/4* | 3/4 | — | 5.3 | 50 |
| 52-C-49-1* | 1 | — | 7.0 | 10 |
| 52-C-49-1-1/4 | 1 1/4 | — | 9.3 | 10 |
| 52C5011/2-25 | 1 1/2 | — | 11.0 | 25 |
| 52C512-25 | 2 | — | 14.8 | 25 |
| For Two Devices — Steel | | | | |
| 52 C 52 1/2 | 1/2 | — | 6.0 | 10 |
| 52-C-52-3/4 | 3/4 | — | 9.0 | 10 |
| 52-C-52-1 | 1 | Square corners | 12.5 | 10 |
| 52-C-52-1-1/4 | 1 1/4 | facilitate tile installation | 15.5 | 10 |
| 52 C 53 1 1/2 | 1 1/2 | — | 19.0 | 10 |
| 52 C 54 2 | 2 3/4 | — | 25.5 | 10 |

* Drawn style.

4" Square Covers



52 C 1

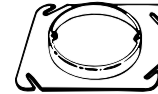

52 C 3 1



52 C 6



| CAT. NO. | RAISED (IN.) | DESCRIPTION | CU. IN. CAP. | STD. CTN. |
|---------------|--------------|----------------------------|--------------|-----------|
| 52 C 1 | — | Flat, blank | — | 100 |
| 52-C-3-25 | 3/8 | Center blanked with tapped | 4.3 | 25 |
| 52-C-3-1/2-25 | 1/2 | ears on 2 3/4" centers | 3.5 | 25 |
| 52-C-3-3/4 | 3/4 | Center blanked with | 4.3 | 25 |
| 52 C 3 1 | 1 | tapped ears on | 5.8 | 25 |
| 52-C-3-1-1/4 | 1 1/4 | 2 5/8" centers | 7.3 | 25 |
| 52 C 6 | — | Flat, with 1/2" KO | — | 100 |

4" Square Device Covers



52 C 16



52 C 19



52 C 21



52 C 0



52 C 10



52 C 14



52-C-36



52 C 00



52-C-17-25

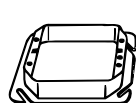

52 C 21

| CAT. NO. | RAISED (IN.) | DESCRIPTION | CU. IN. CAP. | STD. CTN. |
|----------------------------------|--------------|---------------------------|--------------|-----------|
| For Single Device — Steel | | | | |
| 52 C 0 | — | Flat | — | 25 |
| 52 C 62 | 1/4 | Keyed for plaster | 1.5 | 25 |
| 52 C 10 | 1/4 | Offset, keyed for plaster | 1.0 | 25 |
| 52 C 13 | 1/2 | — | 3.0 | 50 |
| 52 C 14 | 3/4 | — | 5.0 | 50 |
| 52 C 14 5/8 | 5/8 | — | 4.0 | 50 |
| 52 C 15 | 1 | — | 7.0 | 25 |
| 52 C 16 | 1 1/4 | — | 8.3 | 25 |
| 52-C-36 | 1/4 | For drywall construction | 1.0 | 25 |
| For Two Devices | | | | |
| 52 C 00 | — | Flat | — | 25 |
| 52C20-25 | 1/4 | — | 2.3 | 25 |
| 52-C-17-25 | 1/2 | — | 6.3 | 25 |
| 52 C 18 | 3/4 | — | 9.0 | 25 |
| 52-C-18-5/8-25 | 5/8 | For drywall construction | 7.3 | 25 |
| 52 C 19 | 1 | — | 12.0 | 25 |
| 52 C 21 | 1 1/4 | — | 15.0 | 25 |
| 52 C 37 | 1/8 | — | 2.3 | 25 |

Square Boxes and Accessories

Box Support Covers

Steel City® Box Support Covers combine a box-to-stud mounting bracket with a device cover in one, easy-to-use product. Designed for use with 4" square boxes, Steel City® Box Support Covers can be used with both steel and wood studs.

- Combines cover and bracket in one component
- Available in one- and two-device versions
- 1/2", 5/8" and 3/4" raised covers
- Speeds installation time
- Needs no far side support
- Can be used with both steel and wood stud
- Can be used without a box as a low voltage device support
- UL and CSA Listed (UL File #E2969, CSA File #LR5043)



52CM13



52CMD17



| CAT. NO. | RAISED (IN.) | # OF DEVICES | CU. IN. CAPACITY | STD. CTN. |
|-------------|--------------|--------------|------------------|-----------|
| 52CM13 | 1/2 | 1 | 3.0 | 25 |
| 52CM14-5/8 | 5/8 | 1 | 4.0 | 25 |
| 52CM14 | 3/4 | 1 | 5.0 | 25 |
| 52CMD17 | 1/2 | 2 | 6.3 | 25 |
| 52CMD18-5/8 | 5/8 | 2 | 7.3 | 25 |
| 52CMD18 | 3/4 | 2 | 9.0 | 25 |

4" Square Surface Covers



RS 4

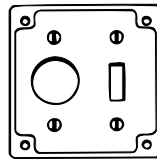

RS 1

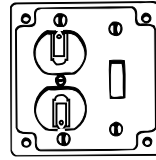

RS 2

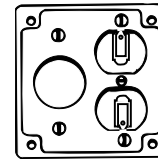

RS 3

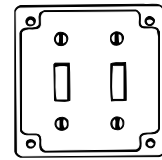

RS 5

| CAT. NO. | DEPTH (IN.) | CU. IN. CAPACITY | DIA. HOLE (IN.) | DESCRIPTION | STD. CTN. |
|-----------|-------------|------------------|-----------------|---|-----------|
| RS 1 | 1/2 | 5.0 | 1 1/2 | For one toggle switch and one single flush receptacle | 50 |
| RS 2* | 1/2 | 5.0 | — | For one toggle switch and one duplex flush receptacle | 50 |
| RS 3* | 1/2 | 5.0 | 1 1/2 | For one single and one duplex flush receptacle | 50 |
| RS 4 | 1/2 | 5.0 | 1 5/8 | For one 4-wire twist-lock single receptacle | 50 |
| RS 5 | 1/2 | 5.0 | — | For two toggle switches | 50 |
| RS 8* | 1/2 | 5.0 | — | For two duplex, flush receptacles | 50 |
| RS 9 | 1/2 | 5.0 | — | For one toggle switch | 50 |
| RS 10 | 1/2 | 5.0 | 1 1/2 | For two single, flush receptacles | 50 |
| RS 11 | 1/2 | 5.0 | 1 1/2 | For one single, flush receptacle | 50 |
| RS 12* | 1/2 | 5.0 | — | For one duplex, flush receptacle | 50 |
| RS 13 | 1/2 | 5.0 | 2 3/32 | For one 30 or 50 amp. dryer or range receptacle | 50 |
| RS 14 | 1/2 | 5.0 | 2 1/2 | — | 50 |
| RS 15 | 1/2 | 5.0 | 1 3/4 | For #3330-30A 250 V twist-lock receptacle | 50 |
| RS-16-CC | 1/2 | 5.0 | — | For one ground fault receptacle | 25 |
| RS-17-CC | 1/2 | 5.0 | — | For two ground fault receptacles | 25 |
| RS-18-CC | 1/2 | 5.0 | — | For one ground fault receptacle and one toggle switch | 25 |
| RS-19-CC* | 1/2 | 5.0 | — | For one ground fault receptacle and one duplex receptacle | 25 |

Remove portion of G.F.I. receptacle ear to mount receptacle to cover. Screws captivated.

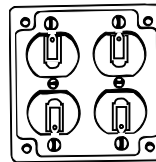

RS 8

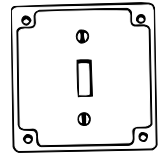

RS 9

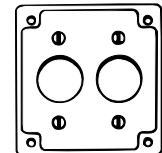

RS 10

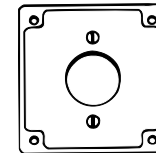

RS 11

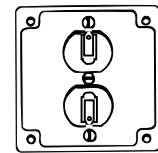

RS 12

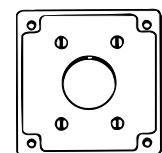

RS 13

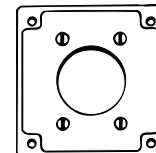

RS 14

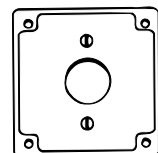

RS 15



RS-16-CC

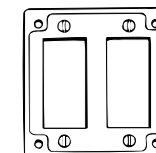

RS-17-CC

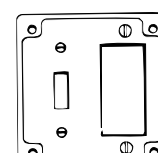

RS-18-CC

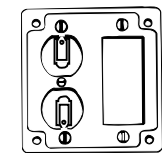

RS-19-CC

Square Boxes and Accessories

UL® Listed Adjustable Mud Ring now available in both single- and two-gang.

Adjustable Mud Rings

Mud Rings feature an inner ring that adjusts from ½" to 1½" in depth to accommodate various drywall thicknesses. Marked with a measured rule and equipped with two adjustment screws, the inner ring can be set to the anticipated depth prior to installation and then easily adjusted after drywall installation to accommodate any variation in depth (½" to 1½").

NEW!



Boxes & Covers — Steel City® Metallic Boxes

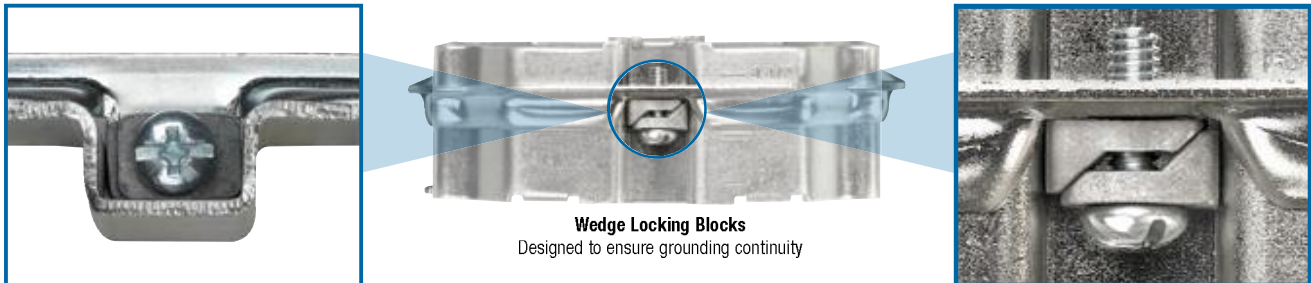

Adjustable Mud Ring Installation/Adjustment Steps:



Loosen...
The two adjustment screws located on opposing corners of the mud ring.



Adjust...
Inner ring to be flush with wall surface.



Re-tighten...
Adjustment screws.



| CAT. NO. | DESCRIPTION | STD. CTN. |
|-----------|--|-----------|
| 52-C-ADJ | Single-Gang Adjustable Mud Ring, ½" to 1½" | 25 |
| 52-C-ADJ2 | Two-Gang Adjustable Mud Ring, ½" to 1½" | 20 |

Square Boxes and Accessories

Steel City® Hands-Free Swivel Hanger

The new Steel City® Hands-Free Swivel Hanger allows you to quickly install high- and low-bay lighting fixtures without the need for an extra set of hands. The hanger design enables the fixture to be set in place, giving users access to the conductors while wiring is being completed. The Hands-Free Swivel Hanger can support a fixture up to 50 pounds and is ideal for gyms or other commercial sites.

- Fits standard 3½" or 4" octagon (SHHFR1234)
- Fits 4" square (SHHF1234) boxes
- A single installer can complete the installation — saving time, labor and cost
- Fixtures can be set in place before wiring is completed
- Design enables users to access the conductors after the fixture has been mounted onto the box
- Accommodates ½" or ¾" threaded fixture pipes
- Permits 20° swing from vertical
- Ideal for gyms or other commercial sites

Material: Zinc-plated sheet-metal hanger and malleable iron swivel connector.

Listing: UL and CSA Listed.

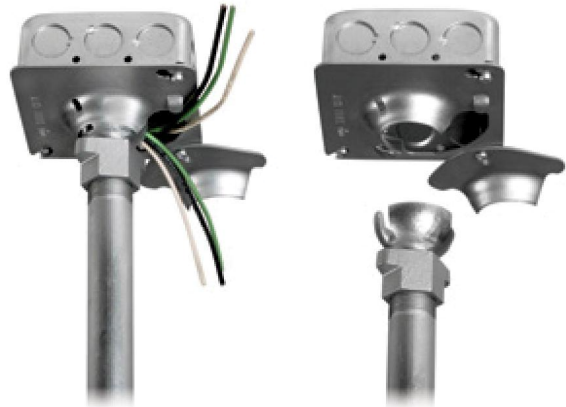

| CAT. NO. | DESCRIPTION | STD. CTN. |
|---------------|----------------------------------|-----------|
| SHHF 1/2 3/4 | Hands-free Swivel Hanger | 25 |
| SHHFR 1/2 3/4 | Hands-free Swivel Hanger (round) | 25 |

Swivel Hangers



SHR 1/2 & 3/4



| CAT. NO. | DESCRIPTION | STD. CTN. |
|---------------|--------------------------------------|-----------|
| SHR 1/2 & 3/4 | Swivel hanger for 4" octagonal boxes | 25 |

UL Listed for 50 lb. fixture support.

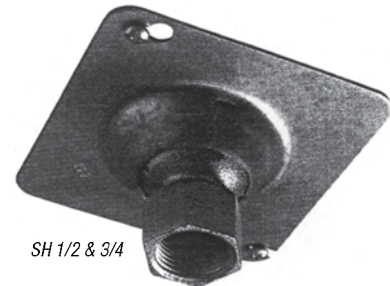

SH 1/2 & 3/4



| CAT. NO. | DESCRIPTION | STD. CTN. |
|--------------|-----------------------------------|-----------|
| SH 1/2 & 3/4 | Swivel hanger for 4" square boxes | 25 |

UL Listed for 50 lb. fixture support.

Square Boxes and Accessories

4¹/₁₆" Square Boxes

| CAT. NO. | DEPTH (IN.) | CU. IN. CAPACITY | EA. SIDE CONDUIT | EA. END CONDUIT | BOTTOM CONDUIT | STD. CTN. |
|-------------------------|-------------|------------------|--|--|--|-----------|
| With Conduit KOs | | | | | | |
| 72151-1/2 & 3/4-E* | 1½ | 29.5 | 3-½", ¾- ³³ / ₆₄ " | 2-½", ¾- ³³ / ₆₄ " | 2-½", ¾"-E, 4-½" | 20 |
| 72171-1/2 & 3/4-E* | 2½ | 42.0 | 3-½" & ¾"-E | 3-½" & ¾"-E | 2-½", ¾"-E, 3-½" | 20 |
| 72171 1 | 2½ | 42.0 | *2-1" | 2-1" | 3-½", 2-¾" | 20 |
| 72171 3/4 1* | 2½ | 42.0 | 1-¾", 1-1" | 1-¾", 1-1" | 3-½", 3-¾", 2-1" | 20 |
| 72171 1 1/4* | 2½ | 42.0 | 2-1¼" | 1-1¼" | 3-½", 2-¾" | 20 |
| 72171CV 1/2 3/4* | 2½ | 42.0 | 2-½", 1-¾" | 2-½", 1-¾" | 3-½", 2-¾" | 25 |
| 72151 MS 1/2 3/4* | 2½ | 42.0 | 3-½", ¾- ³³ / ₆₄ " | 3-½", ¾- ³³ / ₆₄ " | 2-½", ¾- ³³ / ₆₄ ", 3-½" | 20 |
| 72151 MS 1/2 3/4 | 2½ | 42.0 | 3-½", ¾- ³³ / ₆₄ " | 2-½", ¾- ³³ / ₆₄ " | 2-½", 2-¾- ³³ / ₆₄ ", 4-½" | 25 |
| 72171 MS 1/2 3/4* | 2½ | 42.0 | 3-½", ¾- ³³ / ₆₄ " | 3-½", ¾- ³³ / ₆₄ " | 2-½", ¾- ³³ / ₆₄ ", 3-½" | 25 |
| 72151MSX | 2½ | 42.0 | 3-½", ¾- ³³ / ₆₄ " | 2-½", ¾- ³³ / ₆₄ " | 2-½", 2-¾- ³³ / ₆₄ ", 4-½" | 25 |
| 72151MSXP | 2½ | 42.0 | 3-½", ¾- ³³ / ₆₄ " | 2-½", ¾- ³³ / ₆₄ " | 2-½", 2-¾- ³³ / ₆₄ ", 4-½" | 25 |
| 72151MSP | 2½ | 42.0 | 3-½", ¾- ³³ / ₆₄ " | 3-½", ¾- ³³ / ₆₄ " | 3-½", 2-½", ¾- ³³ / ₆₄ " | 25 |
| 72171MSX | 2½ | 42.0 | 3-½", ¾- ³³ / ₆₄ " | 3-½", ¾- ³³ / ₆₄ " | 3-½", 2-½", ¾- ³³ / ₆₄ " | 25 |
| 72171MSXP | 2½ | 42.0 | 3-½", ¾- ³³ / ₆₄ " | 3-½", ¾- ³³ / ₆₄ " | 3-½", 2-½", ¾- ³³ / ₆₄ " | 25 |



72171 MS ½ & ¾
MS bracket for 1½", 2½", 3¾", 4" metal studs

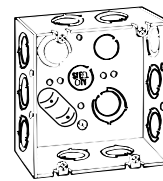

72151-1/2 & 3/4-E



72171-1/2 & 3/4-E

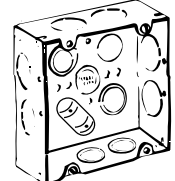

72171 1

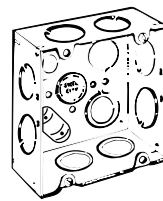

72171 3/4 1

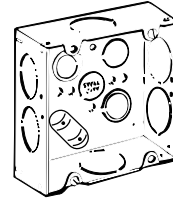

72171 1 1/4

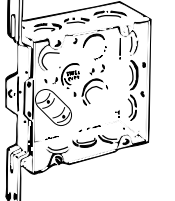

72171CV 1/2 & 3/4

* Per UL 514-A, suitable for use without a bonding jumper in circuits above or below 250 volts.

4¹/₁₆" Square Boxes

| CAT. NO. | DEPTH (IN.) | CU. IN. CAPACITY | DESCRIPTION | CONSTRUCTION TYPE | STD. CTN. |
|------------|-------------|------------------|--|-------------------|-----------|
| 5-SDW-FB-1 | 2½ | 42.0 | Two 1" KOs in each of three sides, flat bracket on other side and three ½" KOs in a line in bottom with two ¾" KOs at opposite ends in bottom. Four tapped ears* | Welded | 25 |

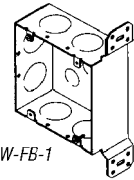

5-SDW-FB-1

4¹/₁₆" Square Box Extension Rings

| CAT. NO. | DEPTH (IN.) | CU. IN. CAPACITY | KNOCKOUT (IN.) | | STD. CTN. |
|-------------------------|-------------|------------------|------------------|-----------------|-----------|
| | | | EA. SIDE CONDUIT | EA. END CONDUIT | |
| With Conduit KOs | | | | | |
| 73151 1/2 3/4* | 1½ | 29.5 | 2-½", 1¼" | 2-½", 1¼" | 20 |
| 73171 1/2 3/4* | 2½ | 42.0 | 2-½", 1¼" | 2-½", 1¼" | 20 |
| 73171 1 | 2½ | 42.0 | 2-1" | 2-1" | 20 |

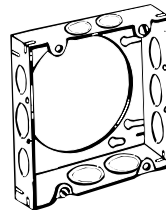

73151 1/2 & 3/4

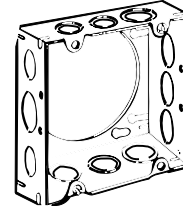

73171 1/2 & 3/4

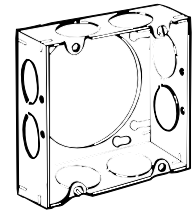

73171 1

4¹/₁₆" Square Covers

| CAT. NO. | CU. IN. CAPACITY | RAISED (IN.) | DESCRIPTION | STD. CTN. |
|------------|------------------|--------------|---|-----------|
| 72 C 1 | — | — | Flat blank | 50 |
| 72 C 6 | — | — | Flat with ½" KO | 25 |
| 72 C 3 | 3.5 | ¾ | Center blanked with tapped ears | 10 |
| 72-C-3-1/2 | 3.0 | ½ | Center blanked with tapped ears on 2 ³ / ₁₆ " centers | 25 |
| 72-C-3-3/4 | 4.3 | ¾ | Center blanked with tapped ears on 2 ³ / ₁₆ " centers | 10 |
| 72-C-3-1 | 5.8 | 1 | Center blanked with tapped ears on 2 ³ / ₁₆ " centers | 25 |



72 C 1



72 C 6

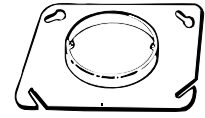

72 C 3

Square Boxes and Accessories

4 1/16" Square Rings and Covers

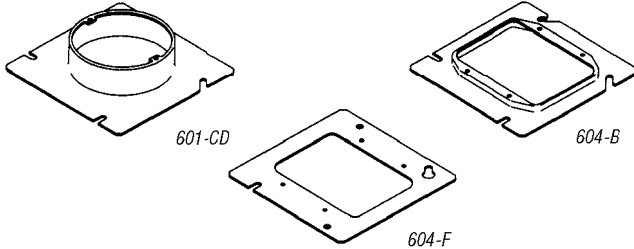

| CAT. NO. | CU. IN. CAPACITY | DESCRIPTION | STD. CTN. |
|----------|------------------|--|-----------|
| 601-CD | 8.8 | 1/4" raised — 4 1/16" square Open plaster ring with ears. Ears tapped 8/32—2 9/32" on centers. Special screw lock feature in slots* | 25 |
| 604-F | — | Flat — 4 1/16" square For two switches or receptacles* | 25 |
| 604-B | 2.8 | 1/4" raised — 4 1/16" square For two switches or receptacles* | 25 |

*Fits any Steel City® 4 1/16" square outlet box or extension ring.

4 1/16" Square Tile Rings

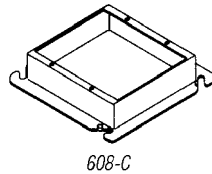

| CAT. NO. | CU. IN. CAPACITY | DESCRIPTION | STD. CTN. |
|----------|------------------|--|-----------|
| 608-C | 12.5 | 1" raised — 4 1/16" square For two switches or receptacles* | 10 |

*Fits any Steel City® 4 1/16" square outlet box or extension ring.

4 1/16" Square Box Partitions

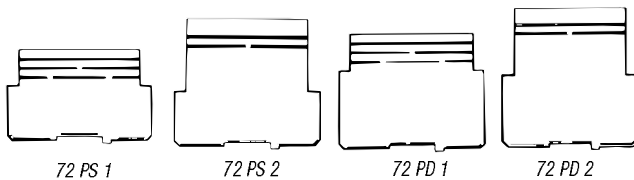

| CAT. NO. | DESCRIPTION | STD. CTN. |
|--|---|-----------|
| For 1 1/2" Deep Box with Square-Cut Tile Wall — Two-Device Covers | | |
| 72 PS 1 | For 1/2", 3/4" and 1" raised covers | 25 |
| 72 PS 2 | For 1 1/4", 1 1/2" and 2" raised covers | 25 |
| For 2 1/4" Deep Box with Square-Cut Tile Wall — Two-Device Covers | | |
| 72 PD 1 | For 1/2", 3/4" and 1" raised covers | 25 |
| 72 PD 2 | For 1 1/4", 1 1/2" and 2" raised covers | 25 |

4 1/16" Square Surface Covers

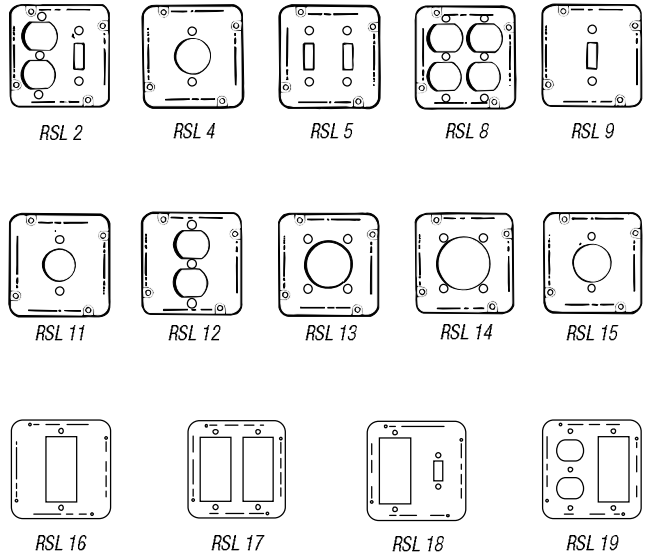

| CAT. NO. | DEPTH (IN.) | CU. IN. CAPACITY | DIA. HOLE (IN.) | DESCRIPTION | STD. CTN. |
|----------|-------------|------------------|-----------------|---|-----------|
| RSL 2 | 1/2 | 7.5 | — | For one toggle switch and one duplex flush receptacle | 10 |
| RSL 4 | 1/2 | 7.5 | 1 1/32 | For one 4-wire twist-lock single receptacle | 10 |
| RSL 5 | 1/2 | 7.5 | — | For two toggle switches | 10 |
| RSL 8 | 1/2 | 7.5 | — | For two duplex, flush receptacles | 10 |
| RSL 9 | 1/2 | 7.5 | 1 5/32 | For one toggle switch | 10 |
| RSL 11 | 1/2 | 7.5 | 1 5/64 | For one single, flush receptacle | 10 |
| RSL 12 | 1/2 | 7.5 | — | For one duplex, flush receptacle | 10 |
| RSL 13 | 1/2 | 7.5 | 2 3/32 | For one 30A to 50A dryer or range receptacle | 10 |
| RSL 14 | 1/2 | 7.5 | 2 1/32 | — | 10 |
| RSL 15 | 1/2 | 7.5 | 1 3/4 | For #3330—30A 250 V twist-lock receptacle | 10 |
| RSL 16 | 1/2 | 7.5 | — | For one ground fault receptacle | 10 |
| RSL 17 | 1/2 | 7.5 | — | For two ground fault receptacles | 10 |
| RSL 18 | 1/2 | 7.5 | — | For one ground fault receptacle and one toggle switch | 10 |
| RSL 19 | 1/2 | 7.5 | — | For one ground fault receptacle and one duplex receptacle | 10 |

Square Boxes and Accessories

4¹¹/₁₆" Square Device Covers

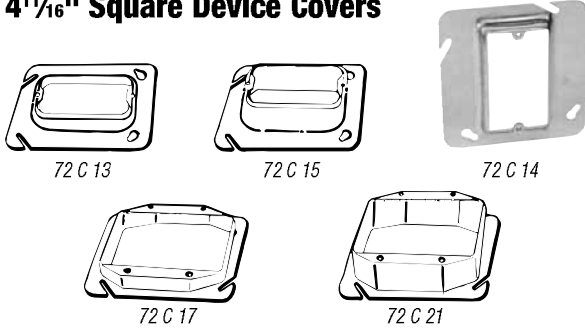

| CAT. NO. | RAISED (IN.) | CU. IN. CAPACITY | STD. CTN. |
|--------------------------|--------------|------------------|-----------|
| For Single Device | | | |
| 72 C 62 | ¼ | 1.0 | 25 |
| 72 C 13 | ½ | 3.0 | 25 |
| 72 C 14 | ¾ | 5.0 | 25 |
| 72 C 14 5/8 | ¾ | 4.0 | 25 |
| 72 C 15 | 1 | 7.0 | 10 |
| 72 C 16 | 1¼ | 8.3 | 10 |
| For Two Devices | | | |
| 72 C 17 | ½ | 6.3 | 25 |
| 72 C 18 | ¾ | 9.0 | 25 |
| 72 C 18 5/8 | ¾ | 7.5 | 25 |
| 72 C 19 | 1 | 12.0 | 25 |
| 72 C 21 | 1¼ | 15.0 | 25 |

4¹¹/₁₆" Square-Cut Tile Wall Covers

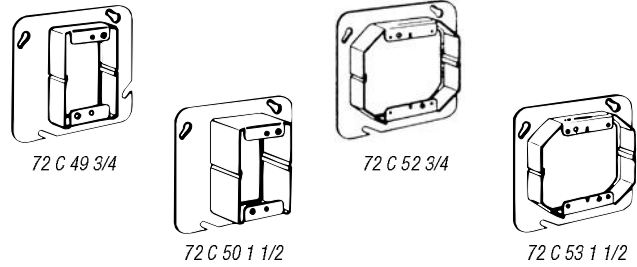

| CAT. NO. | RAISED (IN.) | CU. IN. CAPACITY | STD. CTN. |
|----------------------------------|--------------|------------------|-----------|
| For Single Device — Steel | | | |
| 72-C-49-1/2 | ½ | 3.5 | 10 |
| 72 C 49 3/4 | ¾ | 5.3 | 10 |
| 72-C-49-1 | 1 | 7.0 | 10 |
| 72-C-49-1-1/4 | 1¼ | 7.0 | 10 |
| 72 C 50 1 1/2 | 1½ | 9.0 | 10 |
| 72 C 51 2 | 2 | 14.5 | 20 |
| For Two Devices — Steel | | | |
| 72-C-52-1/2 | ½ | 6.0 | 10 |
| 72 C 52 3/4 | ¾ | 9.0 | 10 |
| 72-C-52-1 | 1 | 12.5 | 25 |
| 72-C-52-1-1/4 | 1¼ | 15.5 | 25 |
| 72 C 53 1 1/2 | 1½ | 19.0 | 10 |
| 72 C 54 2 | 2 | 25.5 | 10 |

4¹¹/₁₆" Square Industrial Device Covers

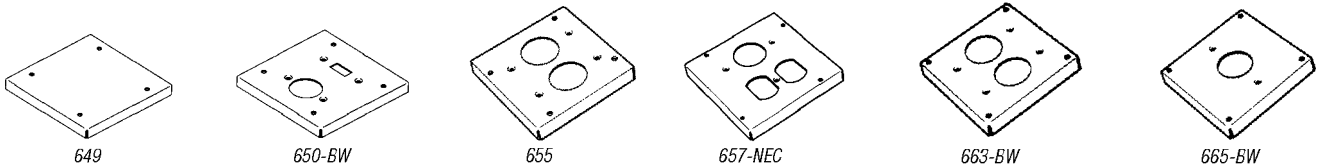

| CAT. NO. | CU. IN. CAPACITY | DESCRIPTION | STD. CTN. |
|----------|------------------|--|-----------|
| 649 | 7.5 | ½" raised — 4 ¹¹ / ₁₆ " square Surface blank. Each cover individually packaged with the necessary screws for mounting* | 10 |
| 650-BW | 7.5 | ½" raised — 4 ¹¹ / ₁₆ " square For one toggle switch and one single receptacle. Opening 1.4" diameter. Each cover individually packaged with the necessary screws for mounting* | 10 |
| 655 | 7.5 | ½" raised — 4 ¹¹ / ₁₆ " square For two single receptacles. Opening 1.4" diameter. Each cover individually packaged with the necessary screws for mounting* | 10 |
| 657-NEC | 7.5 | ½" raised — 4 ¹¹ / ₁₆ " square For one duplex and one single receptacle. Opening 1.4" diameter. Each cover individually packaged with the necessary screws for mounting* | 10 |
| 663-BW | 7.5 | ½" raised — 4 ¹¹ / ₁₆ " square For two three-wire twist lock receptacles. 1 ¹ / ₁₆ " spacing between 1.4" diameter openings. Each cover individually packaged with the necessary screws for mounting* | 10 |
| 665-BW | 7.5 | ½" raised — 4 ¹¹ / ₁₆ " square Opening to accommodate Hubbell 3330 receptacle in center. Opening 1.75" diameter. Each cover individually packaged with the necessary screws for mounting* | 10 |

*Fits any Steel City® 4¹¹/₁₆" square outlet box or extension ring.