

Section 1

Load Centers



QO™ Miniature Circuit Breakers



QO™ Load Centers



Homeline™ Miniature Circuit Breakers



Homeline™ Load Centers



CSEDs



Energy Monitor



Wiring Devices



Schneider Boost and Inverter

EZ Selector - Selection Assistance	1-2
QO™ Miniature Circuit Breakers	1-3
QO™ Load Centers	1-8
Homeline™ Miniature Circuit Breakers	1-19
Homeline™ Load Centers	1-23
QO/Homeline Load Center Value Packs and Accessories	1-28
QO/Homeline Load Center Dimensions	1-34
Combination Service Entrance Devices (CSEDs)	1-37
Solar Ready Plug-On Neutral (PoN) CSEDs	1-45
Circuit Breakers for CSEDs	1-46
Accessories and Hubs for CSEDs	1-47
Schneider Energy Monitor, Boost, Inverter	1-48
Wiring Devices	1-49
Enclosed Devices	1-50



QO Load Center

QO™ and Homeline™ Load Center EZ Selector - Selection Assistance

EZ Selector

Steps to select a load center.

- Select product type:
 - Homeline™ 1 inch format (HOM)
 - QO™ 3/4 inch format with plug-on neutral (QO) (P)
 - QO™ 3/4 inch format (QO)
- Select enclosure type: indoor or outdoor (RB = rainproof)
- Select single phase (1) or three phase (3)
- Select type of main:
 - Main circuit Breaker (M)
 - Main lugs (L)
 - Generator panel (GP)
- Select main ampacity rating
- Select pole spaces and max. number of 1-pole, single-phase circuits
- Select cover style:
 - Surface (box mounted on surface)
 - Surface (box mounted on surface, hinged cover included)
 - Flush (box recessed, cover is flush to wall)
- Value pack (VP)
- Select ground bar option:
 - Ground bar factory installed (T)
 - Ground bar included, field installation (G)
- Select special application:
 - Riser panel with gutter
 - Mfg housing, single phase 3-wire, convertible mains
 - Manufactured housing, single phase, 3-wire
 - Manufactured housing, single phase, 2-wire

QO™ and Homeline™ Load Centers — Catalog Number Description

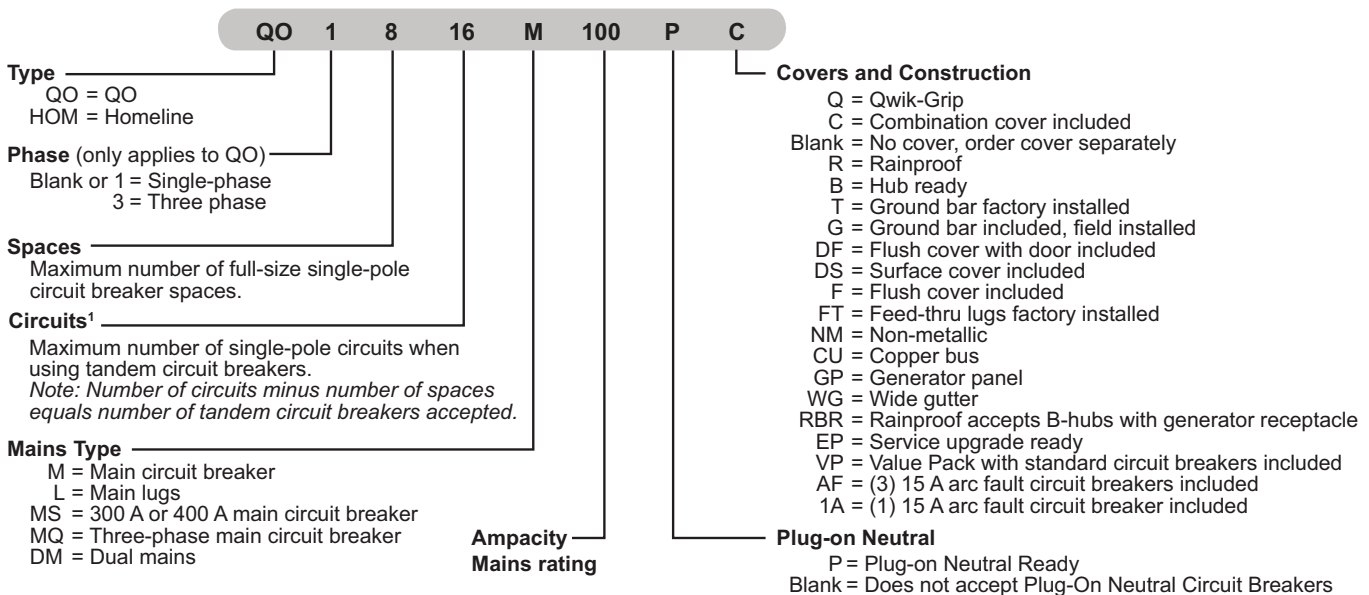

Additional Information

- See **Circuits** [1].
- Search our technical FAQs page: <https://www.se.com/us/en/faqs/home/>
- Refer to catalog [1100CT0501](#).

[1] QO Plug-on neutral load center catalog numbers indicate the number of spaces only. The tables in this document containing QO plug-on neutral load centers list the maximum number of single-pole circuits when using tandem breakers.

QO Standard Plug-On Circuit Breakers

Square D brand QO miniature circuit breakers are plug-on products for use in QO and QON load centers, NQ panelboards, NQ OEM interiors or Speed-D™ switchboard distribution panels. Bolt-on QOB circuit breakers are for use in NQOB and NQ panelboards or interiors. [1]

The Square D exclusive Qwik-Open™ mechanism, with a trip reaction within 1/60th of a second, is standard on all 1P 15 and 20 A QO circuit breakers.

Table 1.1: Standard QO Plug-On Circuit Breakers



Amperes Rating [2]	1P—120/240 Vac	2P—120/240 Vac Common Trip	2P—240 Vac [3] Common Trip	3P—240 Vac Common Trip
10 k AIR				
10 A	QO110	QO210	—	QO310
15 A	QO115 [4] [5]	QO215 [4]	QO215H	QO315 [4]
20 A	QO120 [4] [5]	QO220 [4]	QO220H	QO320 [4]
25 A	QO125 [4]	QO225 [4]	QO225H OBS	QO325 [4]
30 A	QO130 [4]	QO230 [4]	QO230H	QO330 [4]
35 A	QO135 [4]	QO235 [4]	—	QO335 [4]
40 A	QO140 [4]	QO240 [4]	QO240H	QO340 [4]
45 A	QO145 OBS	QO245 [4]	—	QO345 [4]
50 A	QO150 [4]	QO250 [4]	QO250H OBS	QO350 [4]
60 A	QO160 [4]	QO260 [4]	QO260H OBS	QO360 [4]
70 A	QO170 [4]	QO270 [4]	QO270H OBS	QO370 [4]
80 A	—	QO280 [4]	QO280H OBS	QO380 [4]
90 A	—	QO290 [4]	QO290H OBS	QO390 [4]
100 A	—	QO2100 [4]	QO2100H	QO3100 [4]
110 A	—	QO2110 [4]	—	—
125 A	—	QO2125 [4]	—	—
150 A	—	QO2150 [4] [6] [7]	—	—
175 A	—	QO2175 [4] [6] [7]	—	—
200 A	—	QO2200 [4] [6] [7]	—	—
Molded Case Switch 60 A max.—240 Vac		—	QO200	QO300 OBS
22 k AIR [4]				
15 A	QO115VH [5]	QO215VH [8]	—	QO315VH [8]
20 A	QO120VH [5]	QO220VH [8]	—	QO320VH [8]
25 A	—	QO225VH [8]	—	QO325VH [8]
30 A	QO130VH	QO230VH [8]	—	QO330VH [8]
40 A	QO140VH	QO240VH [8]	—	QO340VH [8]
50 A	—	QO250VH [8]	—	QO350VH [8]
60 A	QO160VH	QO260VH [8]	—	QO360VH [8]
70 A	—	QO270VH [8]	—	QO370VH [8]
80 A	—	QO280VH [8]	—	QO380VH [8]
90 A	—	QO290VH [8]	—	QO390VH [8]
100 A	—	QO2100VH [8] [9]	—	QO3100VH [8]
110 A	—	QO2110VH [8] [9]	—	—
125 A	—	QO2125VH [8] [9]	—	—
150 A	—	QO2150VH [6] [8] [7]	—	—
175 A	—	QO2175VH OBS	—	—
200 A	—	QO2200VH [6] [8] [7]	—	—
42 k AIR [4]				
40 A	—	QOH240 OBS	—	—
45 A	—	QOH245 OBS	—	—
50 A	—	QOH250 OBS	—	—
60 A	—	QOH260 [10]	—	—
70 A	—	QOH270	—	—
80 A	—	QOH280	—	—
90 A	—	QOH290	—	—
100 A	—	QOH2100	—	—
110 A	—	QOH2110 [10]	—	—
125 A	—	QOH2125	—	—
65 k AIR [4]				
15 A	QH115 OBS	QH215 OBS	—	QH315 OBS
20 A	QH120 [5]	QH220	—	QH320 OBS
25 A	QH125 OBS	QH225 OBS	—	QH325 [10]
30 A	QH130 OBS	QH230	—	QH330 OBS

OBS This product is obsolete.

Refer to page 7-2 for Interrupting Ratings, Accessories, and Dimensions.

[1] See Digest Section 1 for load centers and Section 9 for panelboards and interiors.

[2] 10–30 A circuit breakers are suitable for use with 60°C or 75°C conductors. 35–125 A circuit breakers are suitable for use with 75°C conductors.

[3] UL Listed 5 k AIR on corner grounded Delta systems.

[4] UL Listed as HACR type for use with air conditioning, heating and refrigeration equipment having motor group combinations and marked for use with HACR type circuit breakers.

[5] UL Listed as SWD (switching duty) rated. Suitable for switching 120 Vac fluorescent lighting loads.

[6] Requires four spaces (1 AWG–300 kcmil Al/Cu.) Suitable for switching 120 Vac fluorescent lighting loads.

[7] Not suitable for use in 3Ø panels. Use only in 1Ø panel rated 150 A or greater.

[8] UL Listed for use ahead of QO, QO-GFI, QO-EPD, QOT, QO-AFI, and QO-PL 10 k AIR circuit breakers to permit their application at 22 kA fault level.

[9] 100 A maximum branch mounted opposite.

[10] Order only. Contact your local Field Office.

Table 1.2: QO/QOB 48 Vdc 5 kA

Ampere Rating	Poles	Suffix
10–60 A	2	5272

QO/QOB Ring Terminal

Table 1.3: QO/QOB Ring Terminal—Factory-Installed Only

Ampere Rating	Poles	Suffix
10–30 A	1, 2, 3	5237
35–60 A	1, 2	5238
35–50 A	3	
70–110 A	2	
60–100 A	3	5273

Wire Sizes for QO/QOB Circuit Breakers

Table 1.4: Wire Sizes for QO/QOB Circuit Breakers

Circuit Breaker Type	Ampere Rating [11]	Wire Size (AWG/kcmil)
QO 1P	10–30 A	14–8 Al/Cu
	10–30 A	(2) 14–10 Cu
	35–70 A	8–2 Al/Cu
QO 2P	10–30 A	14–8 Al/Cu
	10–30 A	(2) 14–10 Cu
	35–70 A	8–2 Al/Cu
	80–125 A	4–2/0 Al/Cu
QO 3P	150–200 A	4–300 Al/Cu
	10–30 A	14–8 Al/Cu, (2) 14–10 Cu
	35–70 A	8–2 Al/Cu
QOB-VH	80–125 A	4–2/0 Al/Cu
	110–150 A	4–300 Al/Cu
QOT	15–20 A	12–8 Al 14–8 Cu
QO-AFI, QO-GFI or QO-EPD	15–30 A	12–8 Al 14–8 Cu
	40, 50, 60 A	12–4 Al 14–6 Cu
QO-PL	10–60 A	12–2 Al 14–2 Cu

QOT and QO Tandem Circuit Breakers

QOT tandem circuit breakers have a mounting cam as shown. Installation into a QO load center can only be made in those positions having a mounting pan rail slot. Meets Paragraph 408.54 of the NEC®. UL Listed as Class CTL.



QOT 1P Tandem
1 Space Required

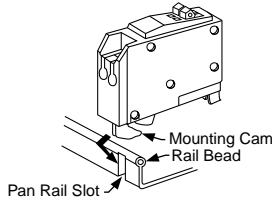

Table 1.5: QOT Tandem Circuit Breakers (CTL)—Not Compatible with Plug-on Neutral Systems

Ampere Rating [11]	Cat. No. [12]
1P—120/240 Vac	
15 A and 15 A	QOT1515
15 A and 20 A	QOT1520
20 A and 20 A	QOT2020
2P—120/240 Vac Common Trip	
Order two QOT1515 or QOT2020 circuit breakers and handle tie QOTHT for common switching of center two poles.	

Table 1.6: QO Tandem Circuit Breakers (non-CTL)—Compatible with Plug-on Neutral Systems

Ampere Rating [11]	Cat. No. [12]
1P—120/240 Vac—1 Space Required	
15 A and 15 A	QO1515
15 A and 20 A	QO1520
20 A and 20 A	QO2020
20 A and 30 A	QO2030
30 A and 20 A	QO3020
Two 1P Individual Trip—120/240 Vac—2 Spaces Required	
15 A and 15 A	Order two QO1515 or QO2020 circuit breakers and handle tie QOTHT
15 A and 20 A	
20 A and 20 A	—
20 A and 30 A	QO20303020 [13]
30 A and 20 A	—

NOTE: The torque values for these products can be found at www.se.com

[11] 10–30 A circuit breakers are suitable for use with 60°C or 75°C conductors. 35–125 A circuit breakers are suitable for use with 75°C conductors.

[12] UL Listed as HACR type for use with air conditioning, heating and refrigeration equipment having motor group combinations and marked for use with HACR type circuit breakers.

[13] Includes two circuit breakers (one QO2030 and one QO3020) and handle tie QOTHT.



1P
QO-GFI



2P
QO-GFI

QO Ground-Fault Circuit Breakers (GFI)

Qwik-Gard™ circuit breakers provide overload and short circuit protection, combined with Class A ground fault protection. Class A denotes a ground fault circuit interrupter that will trip when a fault current to ground is 6 mA or more, for people protection. Do not connect to more than 250 feet of load conductor for the total one-way run to prevent nuisance tripping.

Table 1.7: QO-GFI Circuit Breakers

Circuit Breaker Type	Ampere Rating [14]	Qwik-Gard Circuit Breakers With Ground Fault Circuit Interrupter			
		1P 120 Vac		2P Common Trip 120/240 Vac	3P Common Trip 208Y/120 Vac
		10 k AIR 1 Space Required	22 k AIR 1 Space Required	10 k AIR 2 Spaces Required	10 k AIR 3 Spaces Required
Ground-Fault Circuit Interrupter (Pigtail Neutral)	15	QO115GFI	QO115VHGFI	QO215GFI	QO315GFI
	20	QO120GFI	QO120VHGFI	QO220GFI	QO320GFI
	25	—	—	QO225GFI	—
	30	QO130GFI	—	QO230GFI	QO330GFI
	35	—	—	QO235GFI	—
	40	—	—	QO240GFI	QO340GFI
	45	—	—	QO245GFI	—
	50	—	—	QO250GFI	QO350GFI
Plug-On Neutral Ground-Fault Circuit Interrupter	15	QO115PGFI[16]	—	—	—
	20	QO120PGFI[16]	—	—	—

QO Arc-Fault Circuit Breaker (QO-CAFI)

QO arc-fault circuit breakers provide protection for Series and Parallel Type Arcing as required by the NEC and local code adoption, and comply with UL 1699.

Table 1.8: QO-CAFI Circuit Breakers

Circuit Breaker Type [17]	Ampere Rating	One-Pole 120 Vac		Two-Pole 120/240 Vac
		10 k AIR 1 Space Required	22 k AIR 1 Space Required	10 k AIR 2 Space Required
Combination Arc-fault Interrupter (Pigtail Neutral)	15	QO115CAFI	QO115VHCAFI	QO215CAFI[18]
	20	QO120CAFI	QO120VHCAFI	QO220CAFI[18]
Plug-On Neutral Combination Arc-fault Interrupter	15	QO115PAF	QO115VHPAF	—
	20	QO120PAF	QO120VHPAF	—



1P
QO-CAFI
Plug-On Neutral



1P
QO-CAFI
Pigtail

QO Dual Function Circuit Breaker

QO Combination Arc Fault and Ground Fault Circuit Interrupters (Dual Function) provide overload and short circuit protection, plus arc fault and ground fault protection in accordance with the NEC, UL 1699 and UL 943.

Table 1.9: QO-DF Circuit Breakers

Circuit Breaker Type [17]	Ampere Rating	1P 120 Vac 10 k AIR 1 Space Required	1P 120 Vac 22 k AIR 1 Space Required
Combination Arc-fault and Ground Fault Circuit Interrupter (Pigtail Neutral)	15 20	QO115DF QO120DF	— QO120VHDF
Plug-On Neutral Combination Arc-fault and Ground Fault Circuit Interrupter	15 20	QO115PAFGF QO120PAFGF	QO115VHPAFGF QO120VHPAFGF



1P QO-DF
Plug-on Neutral



1P QO-DF
Pigtail

[14] 10–30 A circuit breakers are suitable for use with 60°C or 75°C conductors. 35–125 A circuit breakers are suitable for use with 75°C conductors.

[15] Suitable only for feeding 240 Vac and 208 Vac two-wire loads. Does not contain load neutral connection.

[16] New Plug-On Neutral

[17] UL Listed as HACR type for use with air conditioning, heating and refrigeration equipment having motor group combinations and marked for use with HACR type circuit breakers.

[18] For 120/240 V only, not for 208Y/120 V.



QO220EPD

QO-EPD/EPE Circuit Breakers

QO-EPD/EPE circuit breakers provide overload and short circuit protection combined with Class B ground fault protection. They are designed to provide ground fault protection of equipment at a 30 mA level (EPD) or 100 mA level (EPE). They are not designed to protect people from electrical shock.

Table 1.10: QO-EPD Circuit Breakers

Ampere Rating [19]	1P 120 Vac 10 k AIR 1 Space Required	2P Common Trip 120/240 Vac 10 k AIR 2 Spaces Required	
15	QO115EPD	QO215EPD	QO315EPE [20]
20	QO120EPD	QO220EPD	QO320EPE [20]
25	QO125EPD OBS	QO225EPD	—
30	QO130EPD	QO230EPD	QO330EPE [20]
40	—	QO240EPD	QO340EPE [20]
50	—	QO250EPD	QO350EPE [20]
60	—	QO260EPD [21]	—

OBS This product is obsolete.

QO Switch Neutral Common Trip Circuit Breakers (QO-SWN)

Switch Neutral Common Trip 2008 NEC® 514.11

Table 1.11: QO-SWN Circuit Breakers

Ampere Rating [22]	2 Wire 120 Vac 10 k AIR 2 Spaces Required
15	QO215SWN
20	QO220SWN

QO High Intensity Discharge Circuit Breakers (QO-HID)

HID circuit breakers are for use on circuits feeding fluorescent and high intensity discharge (HID) lighting systems such as mercury vapor, metal halide, or high pressure sodium. These circuit breakers are physically interchangeable with QO circuit breakers.

Table 1.12: QO-HID Circuit Breakers

Ampere Rating [22]	1P 120/240 Vac 10 k AIR	2P Common Trip 120/240 Vac 10 k AIR	3P Common Trip 240 Vac 10 k AIR
20	—	QO220HID	QO320HID



QO320HID

QO High Magnetic Trip Circuit Breakers (QO-HM)

High magnetic trip circuit breakers are recommended for applications where high initial inrush may occur and for individual dimmer applications.

Table 1.13: QO-HM Circuit Breakers

Ampere Rating [22]	120 Vac—10 k AIR	
	1P	
15 A	QO115HM [23] [24]	
20 A	QO120HM [23] [24]	

Non-Automatic (Standard) Miniature Switches

Miniature non-automatic switches have the same physical packaging as miniature circuit breakers, but open only when the handle is switched to the OFF position.

Non-automatic switches provide no overcurrent protection or short circuit protection. They must not be used on systems that have an available fault current greater than the values listed in the table. Non-automatic switches are UL Listed per UL 1087 and are CSA certified.

Table 1.14: QO Non-Automatic Miniature Switches, 240 Vac 10 kA

Ampere Rating	2P	3P
60	QO200	QO300 OBS

OBS This product is obsolete.

[19] 10–30 A circuit breakers are suitable for use with 60°C or 75°C conductors. 35–125 A circuit breakers are suitable for use with 75°C conductors.

[20] See note in Instruction Bulletin when using in an enclosure with a QO403 or QON prefix.

[21] Suitable only for feeding 240 Vac and 208 Vac two-wire loads. Does not contain load neutral connection.

[22] 10–30 A circuit breakers are suitable for use with 60°C or 75°C conductors. 35–60 A circuit breakers are suitable for use with 75°C conductors.

[23] UL Listed as HACR type for use with air conditioning, heating and refrigeration equipment having motor group combinations and marked for use with HACR type circuit breakers.

[24] UL Listed as SWD (switching duty) rated. Suitable for switching 120 Vac fluorescent lighting loads.

Accessories for QO/QOB Circuit Breakers

Table 1.15: Accessories for use with QO and QOB Miniature Circuit Breakers

Description		Cat. No.	Schedule
Handle Attachments			
Handle Tie	Converts any two adjacent 120/240 Vac 1P QO circuit breakers to independent trip 2P Converts any two adjacent 120/240 Vac1P side-by-side QOT circuit breakers to independent trip 2P	QO1HT QO3HT	DE2E DE2E
Handle Clamp	Clamp for holding QO 1P handle in ON or OFF position Clamp for holding QO or Q1 either 1P, 2P or 3P circuit breaker handles in ON or OFF position	QO1LO HLO1	DE2E DE2E
Handle Padlock Attachment for Padlocking in ON or OFF position	For padlocking 1P QO circuit breaker in ON or OFF position Loose attachment	QOHPL QO1PA	DE2E DE2E
	Fixed attachment		
	For padlocking 1P side-by-side QOT circuit breaker in ON or OFF position	QOTHPA ^{oBS}	DE2E
	For padlocking 2P QO-GFI circuit breakers in either ON or OFF position, fixed attachment.	GFI2PA	DE2A
Handle Padlock Attachment for Padlocking in OFF position	For 2P and 3P QO and Q1 standard circuit breakers which require padlocking in either ON or OFF position. Loose attachment	QO1HPL QO1PL	DE2E DE2E
	Fixed attachment		
	For padlocking 2P and 3P QO circuit breakers in OFF position only, fixed attachment.	QO2PAF	DE2E
Ring Terminal	For padlocking 1P QO, QO-GFI, QO-CAFI, QO-DF and QO-EPD circuit breakers in OFF position only, fixed attachment.	QOADV1PAF	DE2E
	For padlocking 2P QO-GFI, QO-CAFI and QO-EPD circuit breakers in OFF position only, fixed attachment.	QOGF2PAF	DE2E
	Ring terminals are available as a factory-installed option.	See Section 7	DE2A
Sub-feed Lugs	60 A 2P plug-on – 2 spaces required (6–2 Al/Cu) 125 A 2P plug-on – 2 spaces required (12–2/0 Al/Cu) 225 A 2P plug-on – 4 spaces required (4–300 Al/Cu) 125 A 3P plug-on – 3 spaces required (12–2/0 Al/Cu)	QO60SL ^{oBS} QO2125SL QO2225SL [25] QO3125SL	DE2A DE2A DE2A DE3
Mechanical Interlock Attachment	For interlocking the handles of two 2P or one 2P and one 1P QO and Q1 circuit breakers mounted side-by-side so that only one circuit breaker can be ON at a time (Not QOU)	QO2DTI	DE2E
With Retaining Kit	QO2DTI mechanical interlock attachment with retaining kits for securing two adjacent back-fed circuit breakers in dual power supply applications. Can be used with (2) 2Ps or (1) 2P and (1) 1P QO circuit breakers in QO816L100 load centers.	QO2DTIM	DE2E

^{oBS} This product is obsolete.



QO1PA



QO1PL



QO1HT



HLO1



QO1PAF



QO2DTI



QO1HPL



QOTHPA



QO1LO



QOHPL



QO2PAF



QOADV1PAF

[25] Not suitable for use in 3Ø panels. Use only in 1Ø panel rated 150 A or greater.

Factory-Installed Accessories for QO and QOB Miniature Circuit Breakers

Factory-installed electrical accessories take up an additional pole space on QO, QO-GFI, QO-EPD, QO-SWN and QOU circuit breakers. All AC electrical accessories shown below are rated for 50/60 Hz. Accessories are not available for QOB-VH (2P 150 A and 3P 110–150 A) circuit breakers or QO, QOU molded case switches. QO circuit breakers will accept only one accessory per circuit breaker. Undervoltage trip is not available on miniature circuit breakers. Factory-installed accessories are not available for QO-AFI or QO-CAFI Arc Fault Circuit Breakers, QO-CAFI, QO-DF, or QO-PDF circuit breakers, or on QO2150, QO2175, or QO2200 circuit breakers.

Table 1.16: Factory-Installed Accessories for QO/QOB Circuit Breakers^[26]

Accessory	Description	Rated Voltage	Coil Burden	Cat. No. Suffix	Accessory	Description	Contact Comb.	Max. Voltage	Max.	Cat. No. Suffix
Shunt Trip	Trips the circuit breaker from a remote location by means of a trip coil energized from a separate circuit. A 120 Vac shunt trip will operate at 55% or more of rated voltage. All other shunt trips will operate at 75% or more of rated voltage. Application <ul style="list-style-type: none"> For use with momentary or maintained push button. Not available on QO-GFI, QO-EPD, QO-AFI, QO-CAFI, QO-DF, or QO-PDF. Shunt trip terminals accept (2) 0.14– 0.12 AWG Cu. 	12 Vac/Vdc 24 Vac/Vdc	60 VA 168 VA	-1042	Auxiliary Switches	Monitors circuit breaker contact status and provides a remote signal indicating the circuit breaker contacts are OPEN or CLOSED. Application <ul style="list-style-type: none"> Auxiliary switch terminals accept (2) 14–12 AWG Cu leads. Leads (EH): Yellow for "A", Blue for "B", Striped common 18 AWG Cu. 	1A 1B	120 Vac 120 Vac	5 A 5 A	-1200 -1201
		120 Vac 208 Vac 240 Vax	72 VA 228 VA 288 VA	-1021	Alarm Switches	Used with control circuits and is actuated only when the circuit breaker has tripped. Standard construction includes a normally-open contact. Application <ul style="list-style-type: none"> Leads: Alarm switch terminals accept (2) 14–12 AWG Cu leads. 	1A	120 Vac	5 A	-2100

Plug-on Neutral Load Center Main Lugs, Convertible Mains Single Phase 3W—120/240 Vac Indoor—UL Listed

QO Plug-on Neutral Load Centers and CAFI Breakers are engineered for a quick Plug-on Neutral connection on every unit.

Table 1.17: Convertible Main Lugs Plug-on Neutral Load Center (Compatible with QO Plug-on Circuit Breaker and QO Plug-on Neutral Circuit Breakers)

	Mains Rating	Spac- es	Max. Single Pole Circuits ^[1]	Max. Tandem Circuit Breakers	Load Center Box and Interior	Load Center Covers		AI	CU	Bus Rating	Equipment Ground Bar Kit (Factory-Included)	Box No. ^[2]	
						Flush/Surface	Mono-Flat						
INDOOR	Convertible Mains—Factory-installed Main Lugs — 65 kA Short Circuit Current Rating—Copper Bus												
	QOM1 Main Frame Size—Convertible to Main Circuit Breaker												
	125 A	12	24	12	QO112L125PG	QOC16UF ^[3] QOC16US	—	—	6–2/0	—	125	PKGTALP1	6
		16	24	8	QO116L125PG	QOC24UF ^[3] QOC24US	—	—	6–2/0	—	125	PKGTALP1	7
		20	24	4	QO120L125PG	QOC20U100F ^[3] QOC20U100S	—	—	6–2/0	—	125	PKGTALP1	6
		24	34	10	QO124L125PG	QOC24UF ^[3] QOC24US	—	—	6–2/0	—	125	PK15GTAL	7
		30	34	4	QO130L125PG	QOC30U125C	—	—	6–2/0	—	125	PK23GTAL	9
		32	38	6	QO132L125PG	QOC32UF ^[3]	—	—	6–2/0	—	125	PKGTALP1	8
	Convertible Mains—Factory-installed Main Lugs, 65 kA Short Circuit Current Rating—Copper Bus												
	QOM2 Main Frame Size—Convertible to Main Circuit Breaker												
	200 A	12	24	12	QO112L200PG ^{obs}	QOC30UF ^[3] QOC30US	QOCMF30UCW ^[3]	—	4–300	4–250	225	PKGTALP1	9
		24	36	12	QO124L200PG	QOC30UF ^[3] QOC30US	QOCMF30UCW ^[3]	—	4–300	4–250	225	PKGTALP1	9
30		40	10	QO130L200PG	QOC30UF ^[3] QOC30US	QOCMF30UCW ^[3]	—	4–250	—	225	PK23GTAL	9	
40		60	20	QO140L200PG	QOC40UF ^[3] QOC40US	—	—	4–300	4–250	225	PKGTALP2	10	
225 A	42	52	10	QO142L225PG	QOC42UF ^[3] QOC42US	QOCMF42UCW ^[3]	—	4–300	—	225	PK23GTAL	11	
	54	64	10	QO154L225PG	QOC54UF ^[3]	QOCMF54UCW ^[3]	—	4–300	—	225	PK23GTAL	11	

Above listings through 200 A mains rating meet Federal Specification W-P-115c as Type 1, Class 2.
^{obs} This product is obsolete.

[26] QOB circuit breakers with shunt trip, auxiliary switches, and/or alarm switches, which are no longer active commercial references, may be available Factory Assembled into NQ Panelboards.
 [1] Maximum single pole branch circuits utilizing QO and/or QOT circuit breakers.
 [2] See page 1-34
 [3] Available in gray and white. For white equivalencies, add the "W" suffix to the reference, or see page 1-29.

Field-Installed Main Circuit Breaker Kits, 1Ø

Table 1.18: QOM1 Frame Size—Use with Convertible Main Load Centers Only

Main Circuit Breaker Rating [4]	Convertible Load Center Mains Rating	22 k AIR [5]	Lug Wire Size [6] AWG/kcmil
		Main Circuit Breaker	
50 A	100–125	QOM50VH	12–2/0 Al or Cu
60 A	100–125	QOM60VH	
70 A	100–125	QOM70VH	
80 A	100–125	QOM80VH	
90 A	100–125	QOM90VH	
100 A	100–125	QOM100VH	
110 A	125	QOM110VH	
125 A	125	QOM125VH	



QOM1 Frame Size
50–125 Amperes



QOM2 Frame Size
100–225 Amperes

Table 1.19: QOM2 Frame Size—Use with Convertible Main Load Centers Only

Main Circuit Breaker Rating [4]	Convertible Load Center Mains Rating	22 k AIR [5]	Lug Wire Size [6] AWG/kcmil
		Main Circuit Breaker [7]	
100 A	150–225	QOM2100VH	4–300 Al or Cu
125 A	150–225	QOM2125VH	
150 A	150–225	QOM2150VH	
175 A	200–225	QOM2175VH	
200 A	200–225	QOM2200VH	
225 A	225	QOM2225VH	

[4] Do not exceed the load center mains rating.

[5] 22 k AIR main circuit breaker UL Listed for use ahead of QO, QOT and QO-PL 10 k AIR branch circuit breakers to permit their application on systems with up to 22 kA available fault current.

[6] Wire range listed for QOM circuit breaker kits is the wire range of that circuit breaker. To find out maximum wire size permitted in a particular load center per UL, see Main Wire Size in that load center table.

[7] Add suffix 1021 for 120, 208 or 240 Vac shunt trip.

Plug-on Neutral Load Center Main Breaker, Convertible Mains
1Ø3W—120/240 Vac Indoor—UL Listed

QO Plug-on Neutral Load Centers and CAFI Breakers are engineered for a quick Plug-on Neutral connection on every unit.

Table 1.20: Convertible Main Breaker Plug-on Neutral Load Centers (Compatible with QO Plug-on Circuit Breakers and QO Plug-on Neutral Circuit Breakers)

	Mains Rating	Space-s	Max. 1P Circuits	Max. Tandem Breakers	Load Center Box and Interior	Load Center Covers		Al	Cu	Bus Rating	Equipment Ground Bar Kit (Order Separately)	Box No. [8]	
						Flush/Surface	Mono-Flat						
 <p>INDOOR</p> <p>QO154M200P</p>	Convertible Mains — Factory-Installed Main Circuit Breaker— 22 kA Short Circuit Current Rating Convertible to Main Lugs (see below) or Lower Amperage Main Circuit Breaker (see QO Standard Plug-On Circuit Breakers, page 1-3) [9], QOM1 Main Circuit Breaker Frame Size—Copper Bus												
	100 A	12	24	12	QO112M100P	QOC12UF QOC12US	—	6-2/0	6-1	125	PK9GTA	5	
		16	24	8	QO116M100P	QOC20U100F[10] QOC200U100S	—	6-2/0	6-1	125	PK9GTA	6	
		20	24	4	QO120M100P	QOC20U100F[10] QOC200U100S	—	6-2/0	6-1	125	PK9GTA	6	
		24	34	10	QO124M100P	QOC24UF[10] QOC24US	—	6-2/0		125	PK15GTA	7	
		32	38	6	QO132M100P	QOC32UF[10]	—	6-2/0		125	PK15GTA	8	
	125 A	24	34	10	QO124M125P	QOC24UF[10] QOC24US	—	6-2/0		125	PK15GTA	7	
		32	38	6	QO132M125P	QOC32UF[10]	—	6-2/0		125	PK15GTA	8	
		Convertible Mains — Factory-Installed Main Circuit Breaker— 22 kA Short Circuit Current Rating Convertible to Main Lugs (see below) or Lower Amperage Main Circuit Breaker (see QO Standard Plug-On Circuit Breakers, page 1-3) [9], QOM2 Main Circuit Breaker Frame Size—Copper Bus											
	150 A	20	30	10	QO120M150P OBS	QOC30UF[10] QOC30US	QOCMF30UCW[10]	4-250		225	PK15GTA	9	
		24	36	12	QO124M150P	QOC30UF[10] QOC30US	QOCMF30UCW[10]	4-250		225	PK15GTA	9	
		30	40	10	QO130M150P	QOC30UF[10] QOC30US	QOCMF30UCW[10]	4-250		225	PK15GTA	9	
		32	40	10	QO132M150P	QOC40UF[10] QOC40US	—	4-300	4-250	225	PK15GTA	10	
		200 A	20	30	10	QO120M200P OBS	QOC30UF[10] QOC30US	QOCMF30UCW[10]	4-300	4-250	225	PK15GTA	9
			24	36	12	QO124M200P	QOC30UF[10] QOC30US	QOCMF30UCW[10]	4-300	4-250	225	PK15GTA	9
			30	40	10	QO130M200P	QOC30UF[10] QOC30US	QOCMF30UCW[10]	4-250		225	PK15GTA	9
			40	60	20	QO140M200P	QOC40UF[10] QOC40US	—	4-300	4-250	225	PK23GTA	10
			42	52	10	QO142M200P	QOC42UF[10] QOC42US	QOCMF42UCW[10]	4-300		225	PK18GTA	11
			54	72	18	QO154M200P	QOC54UF[10]	QOCMF54UCW[10]	4-300		225	PK23GTA	12
	60		72	12	QO160M200PC [11]	—	—	4-300		225	PK27GTA	24	
	225 A		40	60	20	QO140M225P OBS	QOC42UF[10] QOC42US	QOCMF42UCW[10]	4-300		225	PK23GTA	11
		42	52	10	QO142M225P	QOC42UF[10] QOC42US	QOCMF42UCW[10]	4-300		225	PK18GTA	11	

Above listings through 200 A mains rating meet Federal Specification W-P-115c as Type 1, Class 2.

OBS This product is obsolete.

Field-Installed Main Lugs Kits, 1Ø

Table 1.21: 1Ø Field-Installed Main Lug Kits—Use with Convertible Main Load Centers Only

Main Lugs Rating [12]	Use on Convertible Load Center with Mains Rating	Cat. No.	Lug Wire Size [13] AWG/kcmil Al or Cu
125 A	100–125 A	QOL125 [14]	6–2/0
125 A	100–125 A	QOL125VD [14]	6–4/0
225 A	150–225 A	QOL225 [14]	6–300



QOL125

QOL225

[8] See [Indoor Knockout Information and Enclosure Dimensions, page 1-34](#).

[9] 22 k AIR main circuit breaker UL Listed for use ahead of QO, QOT and QO-PL 10 k AIR branch circuit breakers to permit their application on systems with up to 22 kA available fault current.

[10] Available in gray and white. For white equivalencies, add the "W" suffix to the reference, or see [page 1-29](#).

[11] For Certification to IEC 60439-1 contact the local Square D sales office; otherwise panels are NOT CE marked. (For use on 415Y/240 Vac 3-phase 4-wire, 3,000 Short Circuit Current Rating when QOXD...branch circuit breakers are used and 10,000 Short Circuit Current Rating when QO...VS branch circuit breakers are used).

[12] Do not exceed the load center mains rating.

[13] Wire range listed for QOL lug kits is the wire range of that lug. To find out maximum wire size permitted in a particular load center per UL, see Main Wire Size in that load center table.

[14] If main circuit breaker knockout has been removed from the load center's trim, order appropriate filler plate from [Table 1.51, page 1-25](#)

QO™ Plug-On Neutral Load Centers with Qwik-Grip™

1Ø3W—120/240 Vac Indoor—UL Listed

The Square D QO plug-on neutral load centers with Qwik-Grip simplify rough-in by eliminating the need to remove knockouts, install wire connectors, and blindly pull wire into the load center. A quick bend of the wire using the wire bend guide on the Qwik-Grip insert and the wire slides into the slot. Once inserted, the Qwik-Grip shield snaps on to keep the wire behind the router for a secure, code-compliant installation.



QO Plug-on Neutral Load Center with Qwik-Grip™

Table 1.22: Plug-on Neutral Load Centers with Qwik-Grip (Compatible with QO Plug-on Circuit Breakers and QO Plug-on Neutral Circuit Breakers)

	Mains Rating	Space-s	Max. Single Pole Circuits	Max. Tandem Circuit Breakers	Load Center Box and Interior	Indoor Cover with Door (Order Separately)		Main Wire Size AWG/kcmil		Bus Rating	Equipment Ground Bar Kit	Box No.
						Flush/Surface	Mono-Flat	Al	Cu			
INDOOR	Convertible Mains—Factory-Installed Main Lugs, 65 kA Short Circuit Current Rating—Copper Bus, QOM1 Main Frame Size, Convertible to Main Circuit Breaker											
	125 A	24	34	10	QO124L125PQG	QOC24UF ^[15] QOC24US	—	6-2/0		125	PK15GTAL Included	7Q
		30	34	4	QO130L125PQG ^{OBS}	QOC30U125C	—			125	PK23GTAL Included	9Q
	Convertible Mains—Factory—Installed Main Lugs, 65 kA Short Circuit Current Rating—Copper Bus, QOM2 Main Frame Size, Convertible to Main Circuit Breaker											
	200 A	30	40	10	QO130L200PQG	QOC30UF ^[15] QOC30US	—	6-300		225	PK23GTAL Included	9Q
	225 A	42	52	10	QO142L225PQG	QOC42UF ^[15] QOC42US	—			225	PK23GTAL	9Q
		54	72	18	QO154L225PQG ^{OBS}	QOC54UF ^[15]	—	6-300		225	PK23GTAL Included	12Q
	Convertible Mains—Factory-Installed Main Circuit Breaker, 22 kA Short Circuit Current Rating—Copper Bus, QOM2 Main Frame Size, Convertible to Main Lugs or Main Circuit Breaker											
	200 A	30	40	10	QO130M200PQ	QOC30UF ^[15] QOC30US	—	4-250		225	PK23GTA (Order separately)	11Q
		42	52	10	QO142M200PQ	QOC42UF ^[15] QOC42US	—			225	PK23GTA (Order separately)	11Q
		54	72	18	QO154M200PQ ^{OBS}	QOC54UF ^[15]	—			4-250		225

^{OBS} This product is obsolete.

[15] Available in gray and white. For white equivalencies, add the "W" suffix to the reference, or see page 1-29.

QO Load Centers with Included Cover
1Ø3W—120/240 Vac Indoor—UL Listed

Table 1.23: Load Centers with Included Cover (Compatible with QO Plug-on Circuit Breakers and QO Plug-on Neutral Circuit Breakers)

Mains Rating	Short Circuit Current Rating	Spaces	Max. 1P Circuits [16]	Max. Tandem Circuit Breakers	Load Center [17] Box, Interior, and Cover	Al	Cu	Bus Rating	Equipment Ground Bar Kit	Box No. [18]
125 A	65 kA	12	24	12	QO112L125PGC	6-2/0		125	PKGTALP1 Included	5
	65 kA	20	24	4	QO120L125PGC OBS	6-2/0		125	PKGTALP1 Included	6
	65 kA	24	34	10	QO124L125PGC	6-2/0		125	PK15GTA, LK100AN Included	7
Convertible Mains—Factory-Installed Main Lugs [19]—QOM2 Main Frame Size—Convertible to Main Circuit Breaker (See page 1-3)—Copper Bus										
200 A	65 kA	30	40	10	QO130L200PGC	4-250		225	PK23GTA, LK100AN Included	9
225 A	65 kA	42	52	10	QO142L225PGC	4-300		225	PK23GTA, LK100AN Included	11
	65 kA	54	72	18	QO154L225PGC OBS	4-300		225	PK23GTA, LK100AN Included	12
Convertible Mains—Factory-Installed Main Circuit Breaker—QOM1 Main Frame Size—Convertible to Main Lugs (See page 1-25 or Lower Amperage Main Circuit Breaker (See page 1-3)—Copper Bus [8][20]										
100 A	22 kA	12	24	12	QO112M100PC	6-2/0	6-1	125	PK9GTA	5
	22 kA	16	24	8	QO116M100PC OBS	6-2/0	6-1	125	PK9GTA	6
	22 kA	20	24	4	QO120M100PC	6-2/0	6-1	125	PK9GTA	6
	22 kA	24	34	10	QO124M100PC	4-300		125	PK15GTA	7
Convertible Mains—Factory-Installed Main Circuit Breaker—QOM2 Main Frame Size—Convertible to Main Lugs (See page 1-25 or Lower Amperage Main Circuit Breaker (See page 1-3)—Copper Bus [8][20]										
150 A	22 kA	30	40	10	QO130M150PC	4-250		225	PK15GTA	9
	22 kA	42	52	10	QO142M150PC	4-300		225	PK18GTA	11
200 A	22 kA	30	40	10	QO130M200PC	4-250		225	PK15GTA	9
	22 kA	40	60	20	QO140M200PC	4-300	4-250	225	PK23GTA	10
	22 kA	42	52	10	QO142M200PC	4-300		225	PK18GTA	11
	22 kA	54	72	18	QO154M200PC	4-300		225	PK23GTA	12

OBS This product is obsolete.

Plug-on Neutral Load Center Main Lugs, Convertible Mains
1Ø3W—120/240 Vac Rainproof—UL Listed

QO Plug-on Neutral Load Centers and CAFI Breakers are engineered for a quick Plug-on Neutral connection on every unit.

Table 1.24: Convertible Main Lugs Plug-on Neutral Load Center (Compatible with QO Plug-on Circuit Breakers and QO Plug-on Neutral Circuit Breakers)

Mains Rating	Spaces	Max. Single Pole Circuits [16]	Max. Tandem Circuit Breakers	Load Center Box and Interior	Al	Cu	Bus Rating	Equipment Ground Bar Kit (Factory Included)	Box No. [21]	
R A I N P R O O F	Convertible Mains — Factory-Installed Main Lugs — 65 kA Short Circuit Current Rating [22][19][23] QOM1 Main Circuit Breaker Frame Size, Convertible to Main Circuit Breaker — Equipment Ground Bar Included									
	125 A	12	24	12	QO112L125PGRB	6-2/0		125	PKGTALP1	3R
		16	24	8	QO116L125PGRB	6-2/0		125	PKGTALP1	4R
		24	34	10	QO124L125PGRB	6-2/0		125	PK15GTA	4R
Convertible Mains — Factory-Installed Main Lugs — 65 kA Short Circuit Current Rating [22][19][23] QOM2 Main Circuit Breaker Frame Size, Convertible to Main Circuit Breaker — Equipment Ground Bar Included										
200 A	12	24	12	QO112L200PGRB	4-300	4-250	225	PKGTALP1	5R	
	30	40	10	QO130L200PGRB	4-250		225	PK23GTA	6R	
	40	60	20	QO140L200PGRB	4-300	4-250	225	PKGTALP2	7R	
	42	52	10	QO142L225PGRB	4-300		225	PK23GTA, LK100AN	8R	

Above listings through 200 A mains rating meet Federal Specification W-P-115C as Type 1, Class 2.

[16] Maximum single pole branch circuits utilizing QO and/or QOT circuit breakers.

[17] Order F for flush device or S for surface device.

[18] See page 1-34

[19] UL Listed 5000 A short circuit current rating for corner grounded Delta systems. Use QO-H circuit breakers only.

[20] [9]22 k AIR main circuit breaker UL Listed for use ahead of QO, QOT and QO-PL 10 k AIR branch circuit breakers to permit their application on systems with up to 22 kA available fault current.

[21] See Enclosure Dimensions, page 1-36 or Indoor Enclosure Dimensions and Knockout Information, page 1-34

[22] UL short circuit current rating depends on lowest interrupting rating of circuit breaker installed.

[23] Side hinge door device; allow 1-1/4 in. on left side for door to open.

**Plug-on Neutral Load Center Main Breaker, Convertible Mains
1Ø3W—120/240 Vac Rainproof—UL Listed**

QO Plug-on Neutral Load Centers and CAFI circuit breakers are engineered for a quick Plug-on Neutral connection on every unit.

Table 1.25: Convertible Main Breaker Plug-on Neutral Load Center (Compatible with QO Plug-on Circuit Breakers and QO Plug-on Neutral Circuit Breakers)

	Mains Rating	Spaces	Max. Single Pole Circuits [24]	Max. Tandem Circuit Breakers	Load Center Box and Interior	Al	Cu	Bus Rating	Equipment Ground Bar Kit (Order Separately)	Box No. [25]	
RAI N P R O O F	Convertible Mains — Factory-Installed Main Breaker — 22 kA Short Circuit Current Rating Convertible to Main Lugs (see below) or Lower Amperage Main Circuit Breaker (See page 1-3) [26] QOM1 Main Circuit Breaker Frame Size—Copper Bus										
	100 A	12	24	12		QO112M100PRB	6-2/0		125	PK9GTA	3R
		16	24	8		QO116M100PRB	6-2/0		125	PK9GTA	4R
		20	24	4		QO120M100PRB	6-2/0		125	PK9GTA	4R
		24	34	10		QO124M100PRB	6-2/0		125	PK15GTA	4R
	125 A	24	34	10		QO124M125PRB	6-2/0		125	PK15GTA	4R
	Convertible Mains — Factory-Installed Main Breaker — 22 kA Short Circuit Current Rating Convertible to Main Lugs (see below) or Lower Amperage Main Circuit Breaker (See page 1-3) [26] QOM2 Main Circuit Breaker Frame Size—Copper Bus										
	150 A	20	30	10		QO120M150PRB	4-300	4-250	225	PK15GTA	5R
		30	40	10		QO130M150PRB	4-250		225	PK15GTA	6R
	200 A	20	30	10		QO120M200PRB	4-300	4-250	225	PK15GTA	5R
		30	40	10		QO130M200PRB	4-250		225	PK15GTA	6R
		40	60	20		QO140M200PRB	4-300	4-250	225	PK23GTA	7R
		42	52	10		QO142M200PRB	4-300		225	PK18GTA	8R
	225 A	42	52	10		QO142M225PRB	4-300		225	PK18GTA	8R

Above listings through 200 A mains rating meet Federal Specification W-P-115C as Type 1, Class 2.

[24] Maximum single pole branch circuits utilizing QO and/or QOT circuit breakers.

[25] See Enclosure Dimensions, page 1-36 or Indoor Enclosure Dimensions and Knockout Information, page 1-34

[26] 22 k AIR main circuit breaker UL Listed for use ahead of QO, QOT, QO-GFI, QO-AFI, QO-EPD and QOPL 10 k AIR branch circuit breakers to permit their application on systems up to 22 kA

Backup Power Solutions
1Ø3W—120/240 Vac Backup Power—UL Listed

Table 1.26: Backup Power Solutions

	Mains Rating (A)	Spaces	Max. Single Pole Circuits [27]	Max. Tandem Circuit Breakers	Load Center Box, Interior and Cover	Equipment Grounding Bar Kit (Order Separately)	Main Wire Size AWG/kcmil		Bus Rating	Box No. [28]	
							Al	Cu			
INDOOR	Generator Panels—Manual Transfer for Sub-Feed Applications NEMA 1 (Indoor)										
	Factory-Installed Main Circuit Breakers with Mechanical Interlock—10 kA Short Circuit Current Rating										
	30	4	8	4	QO48M30DSGP	PK7GTA	14–8	14–8	30	4	
	60	4	8	4	QO48M60DSGP		8–2	8–2	60	4	
	Split Bus Plug-on Neutral Load Centers—Manual Transfer for use with Temporary Backup Power Source Applications NEMA 1 (Indoor)										
200	48	48	0	0	QO122X26M200PC ^{OBS}	PK23GTA	4–250	4–250	—	12	
	36	69	34	0	HOM1427X2242M200PC ^{OBS}	PK27GTA	4–250	4–250	—	12	
RAINFROOF	Generator Panels—Manual Transfer with Generator Power Inlet Plug for Sub-Feed Applications NEMA 3R (Outdoor)										
	Factory-Installed Main Circuit Breakers with Mechanical Interlock—10 kA Short Circuit Current Rating										
	100	4	8	4	0	QO1DM10020TRBR ^{OBS}	Factory-Installed	—	8–2	100	17R
		4	8	4	0	QO1DM10030TRBR		—		100	17R
		4	8	4	0	QO1DM10050TRBR		—		100	17R
Split Bus Plug-on Neutral Load Centers—Manual Transfer for use with Temporary Backup Power Source Applications NEMA 1 (Indoor)											
200	48	48	0	0	QO122X26M200PC ^{OBS}	PK23GTA	—	4–250	—	12	

^{OBS} This product is obsolete.

Table 1.27: Manual Power Transfer Accessories

	Description	Cat. No.	Schedule
Manual Transfer Equipment Kit	For interlocking the handles of two 2P or one 2P and one 1P QO and Q1 circuit breakers mounted side-by-side so that only one circuit breaker can be "ON" at a time.	QO2DTI	DE2E
	QO2DTI mechanical interlock attachment with retaining kits for securing two adjacent back-fed circuit breakers in dual power supply applications. Can be used with (2) 2P or (1) 2P and (1) 1P QO circuit breakers in QO816L100 load centers.	QO2DTIM	DE2E
	Secures two 2P circuit breakers to right side of interior when used as back-fed mains, a QO2DTI Kit included for back-up power supply applications. For 1Ø 100–125 ampere convertible main load centers. Series S01 and S02.	PK4DTIM4LA	DE3A
	Secures two 2P circuit breakers to right side of interior when used as back-fed mains, a QO2DTI Kit included for back-up power supply applications. For 1Ø 150–225 ampere convertible main load centers. Series S01 and S02.	PK4DTIM4HA	DE3A
	Secures two 2P circuit breakers to left side of interior when used as back-fed mains, a QO2DTI Kit included for back-up power supply applications. For 1Ø 100–125 ampere convertible main load centers. Series S01 and S02.	PK4DTIM4LAL	DE3A
Generator Circuit Breaker Interlock Kit	For use on "G" and "S" Series NEMA 1 and "G", "S1" and "S2" Series NEMA 3R load centers. Interlocks a QOM1 2P main circuit breaker of a load center (100–125 A) with a QO 2P (15–125 A) branch circuit breaker. Includes a retaining kit.	QOCRBGK1C	DE3A
	For use on "G" and "S" Series NEMA 1 and "G" and "S1" Series NEMA 3R load centers. Interlocks a QOM2 2P main circuit breaker of a load center (150–225 A) with a QO 2P (15–125 A) branch circuit breaker. Includes a retaining kit.	QOCGK2C	DE3A
	For use on "S2" Series NEMA 3R load centers. Interlocks a QOM2 2P main circuit breaker of a load center (150–225 A) with a QO 2P (15–125 A) branch circuit breaker. Includes a retaining kit.	QORBGK2C	DE3A

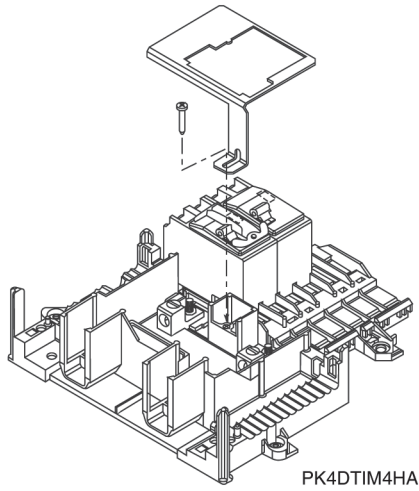

PK4DTIM4HA



QO2DTI



QOCGK2C

[27] Maximum single pole branch circuits utilizing QO and/or QOT circuit breakers.
 [28] See page 1-34 or page 1-36

QO Standard Load Center Main Lugs and Main Breaker, Fixed Mains
1Ø3W—120/240 Vac Special Applications—UL Listed

Table 1.28: Low Amperage Fixed Main Lugs Indoor Load Centers (Accepts Only QO Plug-on Circuit Breakers - Not compatible with QO Plug-on Neutral Circuit Breakers)

	Mains Rating	Spaces	Max. 1P Circuits [29]	Max. Tandem Circuit Breakers	Load Center Box and Interior	Indoor Cover with Door (Order Separately)		Main Wire Size AWG/kcmil		Bus Rating	Equipment Ground Bar Kit (Order Separately)	Box No. [30]
						Flush	Surface	Al	Cu			
INDOOR	Fixed Mains—Factory-Installed Main Lugs—10 kA Short Circuit Current Rating [31]											
	30 A	2	2	0	QO2L30S [32] [33]	Cover Included—Without Door		12–10	14–10	30	PK3GTA1	1
	70 A	2	4	2	QO24L70F / S [34] [35]	Cover Included—Without Door		12–3	14–4	70	PK4GTA	2
	100 A	6	12	6	QO612L100F / S [34] [36]	Cover Included—Without Door		8–1		100	PK7GTA	4
		6	12	6	QO612L100DF / S [34] [36]	Cover Included—With Door				100	PK7GTA	4
		8	16	8	QO816L100F / S [34] [36]	Cover Included—Without Door				100	PK7GTA	4
		8	16	8	QO816L100DF / S [34] [36]	Cover Included—With Door				100	PK7GTA	4
		6	12	6	QO612L100DFCU ^{obs} / QO612L100DSCU [34] [36] [37]	Cover Included—With Door				100	PK7GTA	4
		8	16	8	QO816L100DFCU ^{obs} / QO816L100DSCU [34] [36] [37]	Cover Included—With Door				100	PK7GTA	4
	125 A	4	8	4	QO148L125GF / S [34] [38]	Cover Included—Without Door		12–2/0	14–2/0	125	PK7GTA [39]	21

^{obs} This product is obsolete.

Table 1.29: Low Amperage Fixed Mains Indoor Load Centers with Factory Installed Ground Bar (Accepts Only QO Plug-On Circuit Breakers - Not compatible with QO Plug-on Neutral Circuit Breakers)

	Mains Rating	Short Circuit Current Rating	Spaces	Max. 1P Circuits [29]	Max. Tandem Circuit Breakers	Load Center [34] Box, Interior, and Cover	Equipment Ground Bar Kit (Order Separately)	Main Wire Size AWG/kcmil		Bus Rating	Box No. [40]	
								Al	Cu			
INDOOR	Manufactured Housing: 1Ø2W 120 Vac—Main Lugs Only—CSA Certified											
	30 A [41]	10 kA	2	2	0	QO2L30TTS ^{obs} [42]	Factory-installed	12–10	14–10	30	1	
	50 A	10 kA	2	4	2	QO24L50TTS ^{obs} [43]		—	14–6	70	2	
	1Ø2W 120 Vac—Main Circuit Breaker—CSA Certified											
	30 A	10 kA	3	5	2	QO35FM30TTF ^{obs} / QO35FM30TTS	Factory-installed	[44]		—	3	
	1Ø3W 120/240 Vac—Main Lugs Only—CSA Certified											
	70 A	10 kA	2	4	2	QO24L70TS [43]	Factory Installed	12–3	14–4	70	2	
	100 A	10 kA	6	12	6	QO612L100TF ^{obs}		4–1		100	4	
			6	12	6	QO612L100DTF / S ^{obs} [45]				100	4	
			8	16	8	QO816L100TF ^{obs} / QO816L100TS [45]				100	4	
8			16	8	QO816L100DTF / QO816L100DTS [45]	100				4		

^{obs} This product is obsolete.

Table 1.30: High Amperage Fixed Main Breaker and Main Lugs Indoor Load Centers (Accepts Only QO Plug-On Circuit Breakers - Not compatible with QO Plug-on Neutral Circuit Breakers)

	Mains Rating	Spaces	Max. 1P Circuits [29]	Max. Tandem Circuit Breakers	Load Center Box and Interior	Indoor Cover with Door (Order Separately)		Main Wire Size AWG/kcmil		Equipment Ground Bar Kit (Order Separately)	Box No. [30]	
						Flush	Surface	Al	Cu			
INDOOR	300 A	42	42	0	QONQ42MS300 (Int) [46]	NC62NQVF	NC62NQVS	(1) 4–500		PK27GTA [47] or PK15GTA6	16	
					MH62 (Box) [48]			or (2) 4–3/0				
	400 A	42	42	0	QONQ42MS400 (Int) [46]	NC62NQVF	NC62NQVS	(1) 4–500		PK27GTA [47] or PK15GTA6	16	
					MH62 (Box) [48]			or (2) 4–3/0				
	Fixed Mains—Factory-Installed Main Lugs—65 kA Short Circuit Current Rating [31] [49]											
	400 A	30	30	30	0	QONQ30LS400 (Int) [46]	NC50NQVF	NC50NQVS	(1) 1/0–750		PK27GTA [47] or PK15GTA6	15
42		42	42	0	MH50 (box) [48]	or (2) 1/0–300						
	QONQ42LS400 (Int) [46]				NC50NQVF	NC50NQVS						
MH50 (box) [48]												

Above listings through 200 A mains rating meet Federal Specification W-P-115C as Type 1, Class 2.

- [29] Maximum single pole branch circuits utilizing QO and/or QOT circuit breakers.
- [30] See page 1-34
- [31] UL short circuit current rating depends on lowest interrupting rating of circuit breaker installed.
- [32] Will not accept QO-EPD or Qwik-Gard™ QO-GFI or QO-AFI circuit breakers.
- [33] Mains rated 25 A when Al wire is used.
- [34] Order F for flush device or S for surface device.
- [35] Use 10 AWG maximum size wire for GFI and AFI circuit breakers.
- [36] 70 A Max. branch circuit breaker and 100 A max. back fed main circuit breaker.
- [37] CU indicates copper bus.
- [38] Copper bus.
- [39] Factory-included.
- [40] See Table 1.73 Knockout Information, page 1-34
- [41] Mains rating 25 A when Al wire is used.
- [42] Will not accept Qwik-Gard™ QO-GFI or QO-AFI circuit breaker.
- [43] Use 10 AWG maximum size wire for GFI and AFI circuit breakers.
- [44] Main circuit breaker is a field-installed standard QO single pole circuit breaker. Order separately from page 1-2, page 1-3.
- [45] 70 A max. branch circuit breaker and 70 A max. back fed main circuit breaker.
- [46] Interior only, order box separately.
- [47] PK27GTA includes a 6–2/0 AWG Al/Cu lug.
- [48] PE1A Discount Schedule.
- [49] UL Listed 5000 A short circuit current rating for corner grounded Delta systems. Use QO-H circuit breakers only.

QO Standard Load Center Main Lugs, Fixed Mains

1Ø3W—120/240 Vac Rainproof—UL Listed

Table 1.31: Fixed Main Lugs Rainproof Load Centers (Accepts Only QO Plug-on Circuit Breakers - Not compatible with QO Plug-on Neutral Circuit Breakers)

	Mains Rating	Spaces	Max. Single Pole Circuits [50]	Max. Tandem Circuit Breakers	Load Center Box and Interior	Main Wire Size AWG/kcmil		Bus Rating	Equipment Ground Bar Kit (Order Separately)	Box No. [51]	
						Al	Cu				
RAINPROOF	Non-Metallic Enclosure										
	Fixed Mains—Factory-installed Main Lugs—10 kA Short Circuit Current Rating										
	60 A	2	4	2	QO24L60NRNM	14-4	14-4	60	Factory-installed	1NM	
	Metallic Enclosure										
	Fixed Mains—Factory-installed Main Lugs—10 kA Short Circuit Current Rating										
	40 A	2	2	0	QO2L40RB [52]	12-6	14-6	40	PK3GTA1	1R	
	70 A	2	4	2	QO24L70RB [52]	12-3	14-4	70	PK4GTA	1R	
	100 A	6	12	6	QO612L100RB [53]	8-1		100	PK7GTA	2R	
		6	12	6	QO612L100TRB [53]			100	Factory-installed	2R	
		8	16	8	QO816L100RB [53]			100	PK7GTA	2R	
		6	12	6	QO612L100RBCU [53] [54]			100	PK7GTA	2R	
		8	16	8	QO816L100RBCU [53] [54]			100	PK7GTA	2R	
	125 A	4	8	4	QO148L125GRB [54]	12-2/0	14-2/0	125	PK7GTA Factory-included	15R	

Standard Load Center Main Breaker, Convertible Mains

1Ø3W—120/240 Vac Rainproof—UL Listed

Table 1.32: Convertible Main Breaker Load Centers (Accepts Only QO Plug-on Circuit Breakers - Not compatible with QO Plug-on Neutral Circuit Breakers)

	Mains Rating	Spaces	Max. Single Pole Circuits [50]	Max. Tandem Circuit Breakers	Load Center Box and Interior	Al	Cu	Equipment Ground Bar Kit (Order Separately)	Bus Rating	Box No. [51]
Convertible to Main Lugs (See page 1-25 or Lower Amperage Main Circuit Breaker (See page 1-3) [55], [56])										
QOM1 or QOM2 Main Circuit Breaker Frame Size—Copper Bus										
RAINPROOF	125 A	6	12	6	QO1612M125FTRB [57]	4-2/0		PK12GTA	125	3R
	150 A	8	16	8	QO1816M150FTRB [57]	4-250		PK15GTAL	200	4R
	200 A	8	16	8	QO1816M200FTRB [57]	4-250		PK15GTAL	200	4R

Above listings through 200 A mains rating meet Federal Specification W-P-115C as Type 1, Class 2.

[50] Maximum single pole branch circuits utilizing QO and/or QOT circuit breakers.

[51] See page 1-36 or Indoor Enclosure Dimensions and Knockout Information, page 1-34

[52] Use 10 AWG maximum size wire for GFI and AFI circuit breakers.

[53] 70 A Max. branch circuit breaker and 70 A max. back fed main circuit breaker.

[54] Copper bus.

[55] Side hinge door device; allow 1-1/4 in. on left side for door to open.

[56] 22 k AIR main circuit breaker UL Listed for use ahead of QO, QOT, QO-GFI, QO-AFI, QO-EPD and QOPL 10 k AIR branch circuit breakers to permit their application on systems up to 22 kA

[57] QO1612M125FTRB provided with QOM1 frame main circuit breaker. QO1816M150FTRB and QO1816M200FTRB provided with QOM2 frame main circuit breaker.

QO Riser Panels

1Ø3W—120/240 Vac Special Applications—UL Listed

Table 1.33: Riser Panels for Offset Interior for Wide Gutter—30 A Maximum Branch Circuit Breaker on Left Side of Interior [58], [59] (Compatible with QO Plug-on Circuit Breakers and QO Plug-on Neutral Circuit Breakers)

	Mains Rating	Spaces	Max. Single Pole Circuits [60]	Max. Tandem Circuit Breakers	Load Center Box and Interior	Load Center Cover		Equipment Ground Bar Kit (Order Separately)	Main Wire Size AWG/kcmil		Bus Ratings	Box No. [61]
						Flush	Mono-Flat		Al	Cu		
INDOOR	Convertible Mains—Factory—Installed Main Lugs, 65 kA Short Circuit Current Rating Convertible to QOM1 22 kA Short Circuit Current Rating Main Circuit Breaker (See page) when used with QOC cover below—Copper Bus											
	125 A	12	24	12	QO112L125PWG OBS	QOC20UFWG [62]	NQC20FWGW [62]	PK15GTA	6–2/0		125	14
		20	24	4	QO120L125PWG	QOC20UFWG [62]	NQC20FWGW [62]	PK15GTA			125	14
	Convertible Mains—Factory—Installed Main Lugs, 65 kA Short Circuit Current Rating Convertible to QOM2 22 kA Short Circuit Current Rating Main Circuit Breaker (See page) when used with QOC cover below—Copper Bus											
200 A	30	40	10	QO130L200PWG	QOC30UFWG [62]	NQC30FWGW [62]	PK23GTA	4–250		225	23	
Convertible Mains—Factory—Installed Main Circuit Breaker, 22 kA Short Circuit Current Rating Convertible to Main Lugs (See page) or Lower Amperage QOM2 Main Circuit Breaker (See page) when used with QOC cover below—Copper Bus												
200 A	24	36	12	QO124M200PWG125 [63]	QOC30UFWG [62]	NQC30FWGW [62]	PK23GTA	4–250		225	23	

Above listings through 200 A mains rating meet Federal Specification W-P-115c as Type 1, Class 2.

OBS This product is obsolete.

Panelboard-style Covers for Riser Panels

Mono-Flat™ Front available for riser panels as an alternative to standard load center cover listed above. Provides a low-profile, aesthetically pleasing solution for high-traffic areas in upscale multi-family applications. Deadfront included. Lock kit not provided. Cover NQC30FWG CANNOT be used when panel has been converted to a main circuit breaker panel. [64]

Mains Rating of Load Center	Cat. No.
125 A	NQC20FWG OBS
200 A	NQC30FWG OBS

OBS This product is obsolete.

Table 1.34: Auxiliary Gutter

Cat. No.	Cover	Conduit Riser Size	Width	Height	Depth
UL Listed for use with standard 1Ø and 3Ø load centers for riser applications [65]. For auxiliary gutter-load center compatibility, see catalog number 1100CT0501					
SDAG26	Flush	1-3/4, 2, 2-1/2 or [66] 3	13.50	26.12	3.75

Table 1.35: Tap Kits for Use with Auxiliary Gutter

Cat. No.	Use with Auxiliary Gutter Cat. No.	Riser Wire		Tap Off Wire	
		Lug Type	Al/Cu Wire Size	Lug Type	Al/Cu Wire Size
SDGT30020	SDAG26	Mechanical (Included)	(2) 6 AWG–300 kcmil	Mechanical (Included)	(1) 6–2/0 AWG
SDGT300300	SDAG26	Mechanical (Included)	(2) 6 AWG–300 kcmil	Mechanical (Included)	(1) 6 AWG–300 kcmil
SDGT300C10C	SDAG26	Anderson VCEL030516H1 (Not included)	(2) 4 AWG–300 kcmil	Anderson VCEL02114S1 (Not Included)	(1) 8–1/0 AWG
SDGT300C300C OBS	SDAG26	Anderson VCEL030516H1 (Not included)	(2) 4 AWG–300 kcmil	Anderson VCEL030516H1 (Not included)	(1) 4 AWG–300 kcmil
QOGL20 Grounding Terminals	SDAG26	Mechanical (Included)	(2) 6–2/0 AWG	—	—

OBS This product is obsolete.

[58] UL short circuit current rating depends on lowest interrupting rating of circuit breaker installed.
 [59] UL Listed 5000 A short circuit current rating for corner grounded Delta systems. Use QO-H circuit breakers only.
 [60] Maximum single pole branch circuits utilizing QO and/or QOT circuit breakers.
 [61] See page 1-34
 [62] Available in gray and white. For white equivalencies, add the “W” suffix to the reference, or see page 1-29.
 [63] Comes with 125 A main circuit breaker factory installed.
 [64] Order catalog number PK4FL for field-installed lock kit.
 [65] One tap kit required for each riser wire.
 [66] When used with B300 bolt-on hubs.

QO Standard Load Center Main Lugs and Main Breaker

3Ø4W, 208Y/120 Vac—3Ø4W, 240/120 Vac Delta—3Ø3W, 240 Vac Delta—Indoor and Rainproof—UL Listed

Table 1.36: Main Lugs and Main Breaker Load Centers (Accepts Only QO Plug-on Circuit Breakers—Not compatible with QO Plug-on Neutral Circuit Breakers)

	Mains Rating	Max. Number of 1P QO circuit breakers	Load Center Box and Interior	Indoor Cover with Door (Order Separately)		Main Wire Size AWG/kcmil		Equipment Ground Bar Kit (Order Separately)	Box No. [67]
			Cat. No.	Flush	Surface	Al	Cu		
INDOOR	Fixed Mains—Factory-installed Main Lugs—Copper Bus—65 kA Short Circuit Current Rating [68]								
	60 A	3	QO403L60NF/S	Cover Included With Load Center (No Door)		—	10–6	PK4GTA	13
	125 A	20	QO320L125G [69]	QOC24UF	QOC24US	6–20	6–20	Factory-incl. [70]	7
		24	QO324L125G [69]	QOC24UF	QOC24US			Factory-incl. [70]	7
	200 A	18	QO318L200G [69]	QOC30UF	QOC30US	6–250	6–250	Factory-incl. [71]	9
		30	QO330L200G [69]	QOC30UF	QOC30US			Factory-incl. [71]	9
	225 A	42	QO342L225G [69]	QOC42UF	QOC42US	6–300	6–300	Factory-incl. [71]	11
	Convertible Mains—Factory-installed QDL Main Circuit Breaker—Copper Bus—25 kA Short Circuit Current Rating [72]								
	100 A	27	QO327M100 [73]	QOC30UF	QOC30US	4–2/0	4–2/0	PK15GTA	9
	125 A	30	QO330MQ125 [74] [69]	QOC342MQF	QOC342MQS	4–300	4–300	PK18GTA	12
		30	QO330MQ150 [74] [69]	QOC342MQF	QOC342MQS			PK18GTA	12
	150 A	42	QO342MQ150 [74] [69]	QOC342MQF	QOC342MQS	4–300	4–300	PK23GTA	12
		30	QO330MQ200 [74] [69]	QOC342MQF	QOC342MQS			PK18GTA	12
	200 A	42	QO342MQ200 [74] [69]	QOC342MQF	QOC342MQS	4–300	4–300	PK23GTA	12
		30	QO330MQ225 [74] [69]	QOC342MQF	QOC342MQS			PK23GTA	12
RAINPROOF	Fixed Mains—Factory-installed Main Lugs—Copper Bus—65 kA Short Circuit Current Rating [68] [75]								
	60 A	3	QO403L60NRB	Cover Included		—	10–6	PK4GTA	10R
	125 A	12	QO312L125GRB			6–2/0	6–2/0	Factory Incl. [70]	3R
		20	QO320L125GRB			6–250	6–250	Factory Incl. [71]	6R
	200 A	18	QO318L200GRB			6–300	6–300	Factory Incl. [71]	6R
		30	QO330L200GRB			6–300	6–300	Factory Incl. [71]	8R
	225 A	42	QO342L225GRB	4–2/0	4–2/0	PK15GTA	6R		
	Convertible Mains—Factory-installed QDL Main Circuit Breaker—Copper Bus—25 kA Short Circuit Current Rating [72] [75]								
	100 A	27	QO327M100RB [73]	Cover Included		4–2/0	4–2/0	PK15GTA	6R
	125 A	30	QO330MQ125RB [74]			4–300	4–300	PK18GTA	14R
		30	QO330MQ150RB [74]			4–300	4–300	PK18GTA	14R
	200 A	30	QO330MQ200RB [74]			4–300	4–300	PK18GTA	14R
		42	QO342MQ200RB [74]			4–300	4–300	PK23GTA	14R
	225 A	42	QO342MQ225RB [74]	4–300	4–300	PK23GTA	14R		

Above listings through 200 A mains rating meet Federal Specification W-P-115C as Type 1, Class 2.

Obs This product is obsolete.

Table 1.37: 3Ø, Main Circuit Breakers

Amperage	25 k AIR	65 k AIR	100 k AIR [76]
Field-installed alternate main circuit breakers for QO 3Ø main circuit breaker load centers rated 70–225 A. Do not exceed the load center main rating.			
70 A	QDL32070	QGL32070	QJL32070
80 A	QDL32080	QGL32080	QJL32080
90 A	QDL32090	QGL32090	QJL32090
100 A	QDL32100	QGL32100	QJL32100
110 A	QDL32110	QGL32110	QJL32110
125 A	QDL32125	QGL32125	QJL32125
150 A	QDL32150	QGL32150	QJL32150
175 A	QDL32175	QGL32175	QJL32175
200 A	QDL32200	QGL32200	QJL32200
225 A	QDL32225	QGL32225	QJL32225



QO330MQ200



QO312L125G

Table 1.38: 3Ø, Main Lugs Kits

Main Lugs Amperage Rating	Cat. No.	Lug Wire Size AWG/kcmil
Field-installed main lugs for convertible 3Ø main circuit breaker load centers		
125 A	QOL3125	6–2/0 Cu/Al
225 A	QOL3225	6–300 Cu/Al

[67] See page 1-34

[68] UL short circuit current rating depends on lowest interrupting rating of circuit breaker installed.

[69] For Certification to IEC 60439-1 contact the local Square D sales office; otherwise panels are NOT CE marked. (For use on 415Y/240 Vac 3-phase 4-wire, 3,000 Short Circuit Current Rating when QOXD...branch circuit breakers are used and 10,000 Short Circuit Current Rating when QO...VS branch circuit breakers are used).

[70] PK15GTA.

[71] PK23GTA and LK100AN.

[72] 25 kA short circuit current rating SCCR maximum with Square D Type QDL main circuit breaker, or 22 kA SCCR maximum with back-fed Type QO-VH main circuit breaker, feeding QO 10 k AIR branch circuit breakers.

[73] Includes factory-installed back fed QO3100VH main circuit breaker.

[74] 65 kA Short Circuit Current Rating maximum with field-installed Square D type QGL 65 k AIR minimum main circuit breaker feeding QO and Q1 10 k AIR minimum branch circuit breakers.

[75] Side hinge door device allow 1-1/4 in. on left side for door to open.

[76] When these 3P circuit breakers are used as the main circuit breaker of a 3Ø load center, the maximum AIR rating is 65 kA at 240 Vac and 100 kA at 208 Vac.



HOM 1P and 2P



HOM2200BB Branch Circuit Breaker
4 Spaces Required

Homeline Standard Plug-On Circuit Breakers

The Square D Homeline circuit breakers are in a 1 in. wide format for 1-pole circuit breakers. They are designed to plug into Homeline load centers.

Table 1.39: Standard HOM Plug-on Circuit Breakers

Ampere Rating	AIR	1P—120 Vac, 1 Space Required	2P—120/240 Vac Common Trip 2 Spaces Required.
15 A	10 kA	HOM115 [1][2]	HOM215 [2]
20 A	10 kA	HOM120 [1][2]	HOM220 [2]
25 A	10 kA	HOM125 [2]	HOM225 [2]
30 A	10 kA	HOM130 [2]	HOM230 [2]
35 A	10 kA	—	HOM235 [2]
40 A	10 kA	HOM140 [2]	HOM240 [2]
45 A	10 kA	—	HOM245 [2]
50 A	10 kA	HOM150 [2]	HOM250 [2]
60 A	10 kA	—	HOM260 [2]
70 A	10 kA	—	HOM270 [2]
80 A	10 kA	—	HOM280 [2]
90 A	10 kA	—	HOM290 [2]
100 A	10 kA	—	HOM2100 [2]
110 A	10 kA	—	HOM2110 [2]
125 A	10 kA	—	HOM2125 [2]
150 A	10 kA	—	HOM2150BB [2][3]
175 A	10 kA	—	HOM2175BB [2][3]
200 A	10 kA	—	HOM2200BB [2][3]

Homeline High Magnetic Circuit Breakers (HOM-HM)

High magnetic trip circuit breakers are recommended for applications where high initial inrush current may occur.

Table 1.40: HOM-HM Circuit Breakers

Amperes	1P—120/240 Vac	2Ps
20 A	HOM120HM [2]	—

Homeline Ground-Fault Circuit Breaker (HOM-GFI)

HOM-GFI circuit breakers provide overload and short circuit protection, combined with Class A ground fault protection. Class A denotes a ground fault circuit interrupter that will trip when a fault current to ground is 6 milliamperes or more.

Table 1.41: HOM-GFI Circuit Breakers

Circuit Breaker Type	Ampere Rating	AIR	1P—120 Vac 1 Space Required	2P—120/240 Vac Common Trip 2 Spaces Required
Ground-Fault Circuit Interrupter(Pigtail Neutral)	15 A	10 kA	HOM115GFI	HOM215GFI
	20 A	10 kA	HOM120GFI	HOM220GFI
	25 A	10 kA	—	HOM225GFI
	30 A	10 kA	—	HOM230GFI
	35 A	10 kA	—	HOM235GFI
	40 A	10 kA	—	HOM240GFI
	45 A	10 kA	—	HOM245GFI
Plug-On Neutral Ground-Fault Circuit Interrupter	15 A	10 kA	HOM115PGFI	—
	20 A	10 kA	HOM120PGFI	—



HOM 1P GFI
(With Ground Fault
Circuit Interrupter)
1 Space Required



HOM 2P GFI
(With Ground Fault
Circuit Interrupter)
2 Spaces Required

[1] UL Listed as SWD (switching duty) rated. Suitable for switching 120 Vac fluorescent lighting loads.

[2] UL Listed as HACR type for use with air conditioning, heating and refrigeration equipment having motor group combinations and marked for use with HACR type circuit breakers.

[3] Requires four spaces (1 AWG–300 kcmil Al/Cu). Use only in 1Ø panel rated 150 A or greater.



HOM 1P CAFE
Plug-on Neutral



HOM 1P CAFE
Pigtail



HOM 1P DF
Plug-on Neutral



HOM 1P DF
Pigtail

Homeline Combination Arc Fault Circuit Interrupters (HOM-CAFI)

Homeline Combination Arc Fault Circuit Interrupters—Provide overload and short circuit protection, plus arc fault protection in accordance with the NEC and UL 1699.

Table 1.42: HOM-CAFI Circuit Breakers

Circuit Breaker Type	Ampere Rating	Poles 120 Vac	Cat. No.
One-Pole			
Combination Arc-Fault Circuit Interrupter with Pigtail Neutral	15 A	1	HOM115CAFI [4]
	20 A	1	HOM120CAFI [4]
Plug-On Neutral Combination Arc-Fault Interrupter	15 A	1	HOM115PCAIFI [4]
	20 A	1	HOM120PCAIFI [4]
Two-Pole			
Combination Arc-Fault Circuit Interrupter with Pigtail Neutral	15 A	2	HOM215CAFI [4] [5]
	20 A	2	HOM220CAFI [4] [5]

Homeline Dual Function Circuit Breaker (HOM-DF)

Homeline Combination Arc Fault and Ground Fault Circuit Interrupters (Dual Function)—Provide overload and short circuit protection, plus arc fault and ground fault protection in a single device in accordance with the NEC, UL 1699 and UL943.

Table 1.43: HOM-DF Circuit Breakers

Circuit Breaker Type	Ampere Rating	Poles 120 Vac	Cat. No.
Combination Arc-Fault and Ground Fault Circuit Interrupter with Pigtail Neutral	15 A	1	HOM115DF [4]
	20 A	1	HOM120DF [4]
Plug-On Neutral Combination Arc-Fault and Ground Fault Circuit Interrupter	15 A	1	HOM115PDF [4]
	20 A	1	HOM120PDF [4]

Homeline Equipment Protection Device (HOM-EPD)

Homeline Equipment Protection Device—Circuit Breakers with 30 mA Equipment Ground Fault Protection (UL Listed).

Table 1.44: HOM-EPD Circuit Breakers

Amperes	1P—120 Vac	2P—120/240 Vac Common Trip
20 A	HOM120EPD	HOM220EPD
30 A	—	HOM230EPD
40 A	—	HOM240EPD
50 A	—	HOM250EPD

[4] UL Listed as HACR type for use with air conditioning, heating and refrigeration equipment having motor group combinations and marked for use with HACR type circuit breakers.

[5] For 120/240 V only, not for 208Y/120 V.

Homeline Tandem and Quad Tandem Circuit Breakers (HOMT)

Table 1.45: HOMT Tandem Circuit Breakers

Ampere Rating [6]	AIR	1P Tandem—120/240 Vac (One Space Required)
15 and 15 A	10 kA	HOMT1515 [7]
15 and 20 A	10 kA	HOMT1520 [7]
20 and 20 A	10 kA	HOMT2020 [7]
30 and 15 A	10 kA	HOMT3015 [7]
30 and 20 A	10 kA	HOMT3020 [7]



HOMT Tandem Circuit Breaker

Table 1.46: HOMT Quad Tandem 1P Circuit Breakers

Ampere Rating [6]		AIR	2P Tandem—120/240 Vac (Two Spaces Required)
1P	2P		
(2) 15 A	15 A	10 kA	HOMT1515215
(2) 15 A	20 A	10 kA	HOMT1515220
(2) 15 A	30 A	10 kA	HOMT1515230
(2) 15 A	40 A	10 kA	HOMT1515240
(2) 15 A	50 A	10 kA	HOMT1515250
(2) 20 A	20 A	10 kA	HOMT2020220
(2) 20 A	25 A	10 kA	HOMT2020225
(2) 20 A	30 A	10 kA	HOMT2020230
(2) 20 A	40 A	10 kA	HOMT2020240
(2) 20 A	50 A	10 kA	HOMT2020250



HOMT1515215
2 Spaces Required

NOTE: Typical catalog no. (e.g. HOMT 1515230) represents two 1P, outer poles (two 15 A 1P CBs) and one 2P inner circuit breaker with common trip (one 30 A 2P CB).

Table 1.47: HOMT Quad Tandem 2P Circuit Breakers

Ampere Rating [6]		AIR	(2) 2P Tandem—120/240 Vac (Two Spaces Required)
2P	2P		
15 A	15 A	10 kA	HOMT215215
15 A	20 A	10 kA	HOMT215220
15 A	25 A	10 kA	HOMT215225
15 A	30 A	10 kA	HOMT215230
15 A	40 A	10 kA	HOMT215240
15 A	50 A	10 kA	HOMT215250
20 A	20 A	10 kA	HOMT220220
20 A	25 A	10 kA	HOMT220225
20 A	30 A	10 kA	HOMT220230
20 A	40 A	10 kA	HOMT220240
20 A	50 A	10 kA	HOMT220250
25 A	25 A	10 kA	HOMT225225
25 A	30 A	10 kA	HOMT225230
25 A	40 A	10 kA	HOMT225240
25 A	50 A	10 kA	HOMT225250
30 A	30 A	10 kA	HOMT230230
30 A	40 A	10 kA	HOMT230240
30 A	50 A	10 kA	HOMT230250



HOMT225225
2 Spaces Required

NOTE: Typical catalog no. (i.e. HOMT215230) represents two 2P; outer poles (one 15 A 2P with common trip) and inner poles (one 30 A 2P with common trip).

[6] 15–20 A tandem or quad tandem circuit breakers are suitable for use with 60°C or 75°C conductors. 25–50 A tandem or quad tandem circuit breakers are suitable for use with 75°C conductors only.

[7] UL Listed as HACR type for use with air conditioning, heating and refrigeration equipment haing motor group combinations and marked for use with HACR type circuit breakers.

Homeline Circuit Breaker Wire Sizes

Table 1.48: Wire Sizes for Homeline Circuit Breakers

Breaker Type	Ampere Rating	Wire Size (AWG/kcmil) [8]	
		Aluminum	Copper
HOM 1P	15–30 A	14–8 AWG	14–8 AWG or (2) 14–10 AWG
	40–50 A	8–2 AWG	8–2 AWG
HOM 2P	15–30 A	14–8 AWG	14–8 AWG or (2) 14–10 AWG
	35–70 A	8–2 AWG	8–2 AWG
	80–125 A	4–2/0 AWG	4–2/0 AWG
	150–200 A	4 AWG–300 kcmil	4 AWG–300 kcmil
HOMT and Quad	15–30 A	14–8 AWG	14–8 AWG
Quad Only	40–50 A	6–12 AWG	6–14 AWG
HOM-GFI - 1P	15–20 A	14–10 AWG	14–10 AWG
HOM-GFI - 2P	15–50 A	12–4 AWG	14–6 AWG

Accessories for Homeline Circuit Breakers

Table 1.49: Accessories for Use with Homeline Circuit Breakers

Description	Cat. No.	
Handle Attachments		
Handle Tie: Converts any two adjacent 120/240 Vac single HOM circuit breakers to independent trip 2P	HOM1HT	
Handle Tie: Converts any two adjacent 120/240 Vac 1P side-by-side HOMT circuit breakers to independent trip 2P	HOMTHT	
Handle Clamp: Clamp for holding HOM 1P handle in the ON or OFF position	QO1LO	
Handle Blocking Device: Attaches to standard HOM 2P circuit breakers for holding the handle in the OFF position	HOM2HBD	
Handle Padlock Attachment: For padlocking 1P Standard HOM breakers in the ON or OFF position	HOM1PA	
Handle Padlock Attachment: For padlocking 2P Standard HOM circuit breakers in ON or OFF position	15–70 A	HOM2PALA
	80–125 A	HOM2PAHA
Handle Padlock Attachment: For padlocking 1P CAFI, DF, GFI, and EPD HOM breakers in ON or OFF position	HOMELEC1PA	
Handle Padlock Attachment: For padlocking 2P CAFI, GFI, and EPD HOM breakers in ON or OFF position	HOMELEC2PALA	
Handle Padlock Attachment: For padlocking center poles of Homeline Quad breakers in the OFF position	HOMQPA	
Handle Padlock Attachment: For padlocking main circuit breakers in convertible load center in OFF position	50–125 A	QOM1PA [9]
	100–225 A	QOM2PA [9]
Sub-Feed Lugs		
125 A 2P plug-on—2 spaces required	HOML2125	
225 A 2P plug-on—4 spaces required	HOML2225 [10]	

OBS This product is obsolete.

[8] 15–30 A circuit breakers are suitable for use with 60°C or 75°C conductors. 40–125 A circuit breakers are suitable for use with 75°C conductors.

[9] 50–125 A QOM1 frame size; 100–225 A QOM2 frame size.

[10] Requires four spaces (1 AWG–300 kcmil Al/Cu). Use only in 1Ø panel rated 150 A or greater.

HOM Standard Load Center Main Lugs, Fixed Mains
1Ø3W—120/240 Vac Indoor—UL Listed

Table 1.50: Fixed Main Lugs Load Centers (Accepts Only HOM Plug-on Circuit Breakers - Not compatible with HOM Plug-on Neutral Circuit Breakers)

	Mains Rating	Spaces	Max. Single Pole Circuits [1]	Max. Tandem Circuit Breakers	Load Center Box, Interior and Cover [2]	Main Wire Size AWG/kcmil		Bus Rating	Equipment Ground Bar Kit (Order Separately)	Box No. [3]	
						Al	Cu				
INDOOR	Main Lugs—10 kA Short Circuit Current Rating Order HOM Circuit Breakers (See page 1-19) Factory-installed Fixed Main Lugs										
	70 A	2	4	2	HOM24L70F/S[4] [5]	12-3	14-4	70	PK3GTA1	2	
	100 A	6	12	6	HOM612L100F/S[4] [6]	8-1		100	PK7GTA	4	
	125 A	4	8	4	HOM48L125GC	12-2/0	14-2/0	125	PK7GTA Included	21	

HOM Plug-on Neutral Load Center Main Lugs, Convertible Mains
1Ø3W—120/240 Vac Indoor—UL Listed

Table 1.51: Convertible Main Lugs Plug-on Neutral Load Centers (Compatible with HOM Plug-on Circuit Breakers and HOM Plug-on Neutral Circuit Breakers)

	Mains Rating	Spaces	Max. Single Pole Circuits [1]	Max. Tandem Circuit Breakers	Load Center Box, Interior and Cover [2]	Main Wire Size AWG/kcmil		Bus Rating	Equipment Ground Bar Kit (Order Separately)	Box No. [3]	
						Al	Cu				
INDOOR	Convertible Mains—Factory-installed Main Lugs										
	QOM1 Main Frame Size—Convertible to Main Circuit Breaker (See page 1-27)										
	125 A	8	16	8	HOM816L125PC	6-2/0	6-1	125	PK9GTA	6	
		12	24	12	HOM1224L125PC		6-1	125	PK15GTA	6	
		16	32	16	HOM1632L125PC ^{obs}		6-1/0	125	PK15GTA	8	
		20	40	20	HOM2040L125PC		6-1/0	125	PK18GTA	8	
		30	60	30	HOM3060L125PC		6-2/0	125	PK23GTA	10	
	Convertible Mains—Factory-installed Main Lugs										
	QOM2 Main Frame Size—Convertible to Main Circuit Breaker (See page 1-27)										
	225 A	30	60	30	HOM3060L225PC	4-300	4-250	225	PK23GTA	10	
		40	80	40	HOM4080L225PC			225	PK27GTA	12	
		42	84	42	HOM4284L225PC			225	PK27GTA	12	
		60	120	60	HOM60120L225PC			225	PK27GTA	25	
	Convertible Mains—Factory-installed Main Lugs—Ground Bar Included										
	QOM1 Main Frame Size—Convertible to Main Circuit Breaker (See page 1-27)										
	125 A	8	16	8	HOM816L125PGC	6-2/0	6-1	125	PKGTALP1 Included	6	
		12	24	12	HOM1224L125PGC		6-1	125	PKGTALP1 Included	6	
		20	40	20	HOM2040L125PGC		6-1/0	125	PKGTALP1 Included	8	
		24	48	24	HOM2448L125PGC		6-1/0	125	PKGTALP2 Included	8	
	Convertible Mains—Factory-installed Main Lugs—Ground Bar Included										
QOM2 Main Frame Size—Convertible to Main Circuit Breaker (See page 1-27)											
225 A	30	60	30	HOM3060L225PGC	4-300	4-250	225	PKGTALP2 Included	10		
	16	32	16	HOM1632L225PGC ^{obs}			225	PKGTALP1 Included	9		
	20	40	20	HOM2040L225PGC			225	PKGTALP1 Included	9		
	40	80	40	HOM4080L225PGC			225	PKGTALP3 Included	12		
	42	84	42	HOM4284L225PGC			225	PKGTALP3 Included	12		

Above listings through 200 A mains rating meet Federal Specification W-P-115c as Type 1, Class 2.
^{obs} This product is obsolete.

[1] Maximum single pole branch circuits utilizing HOM and/or HOMET circuit breakers.
 [2] C at end of catalog number indicates combination flush/surface cover included with device.
 [3] See page 1-34
 [4] F/S at end of catalog number indicates to order F for flush device or S for surface device. The cover does not have a door.
 [5] HOM-GFI and HOM-AFI branch circuit breakers are limited to number 10 maximum wire.
 [6] 70 A maximum branch circuit breaker, 100 A maximum back feed main circuit breaker.

Field-Installed Main Circuit Breaker Kits, 1Ø

Table 1.52: QOM1 Frame Size—Use with Convertible Main Load Centers Only



QOM1 Frame Size
50–125 Amperes

Main Circuit Breaker Rating [7]	Convertible Load Center Mains Rating	22 k AIR [8]		Lug Wire Size [9] AWG/kcmil
		Main Circuit Breaker		
50 A	100–125	QOM50VH		12–2/0 Al or Cu
60 A	100–125	QOM60VH		
70 A	100–125	QOM70VH		
80 A	100–125	QOM80VH		
90 A	100–125	QOM90VH		
100 A	100–125	QOM100VH		
110 A	125	QOM110VH		
125 A	125	QOM125VH		

Table 1.53: QOM2 Frame Size—Use with Convertible Main Load Centers Only



QOM2 Frame Size
100–225 Amperes

Main Circuit Breaker Rating [7]	Convertible Load Center Mains Rating	22 k AIR [8]		Lug Wire Size [9] AWG/kcmil
		Main Circuit Breaker [10]		
100 A	150–225	QOM2100VH		4–300 Al or Cu
125 A	150–225	QOM2125VH		
150 A	150–225	QOM2150VH		
175 A	200–225	QOM2175VH		
200 A	200–225	QOM2200VH		
225 A	225	QOM2225VH		

[7] Do not exceed the load center mains rating.

[8] 22 k AIR main circuit breaker UL Listed for use ahead of QO, QOT and QO-PL 10 k AIR branch circuit breakers to permit their application on systems with up to 22 kA available fault current.

[9] Wire range listed for QOM circuit breaker kits is the wire range of that circuit breaker. To find out maximum wire size permitted in a particular load center per UL, see Main Wire Size in that load center table.

[10] Add suffix 1021 for 120, 208 or 240 Vac shunt trip.

HOM Plug-on Neutral Load Center Main Breaker, Convertible Mains
1Ø3W—120/240 Vac Indoor—UL Listed

Table 1.54: Convertible Main Breaker Plug-on Neutral Load Centers (Compatible with HOM Plug-on Circuit Breakers and HOM Plug-on Neutral Circuit Breakers)

	Mains Rating	Spaces	Max. Single Pole Circuits [11]	Max. Tandem Circuit Breakers	Load Center Box, Interior and Cover [12]	Main Wire Size AWG/kcmil		Bus Rating	Equipment Ground Bar Kit (Order Separately)	Box No. [13]	
						Al	Cu				
INDOOR	Main Circuit Breaker—22 kA Short Circuit Current Rating										
	Convertible Mains—Factory-installed Main Circuit Breaker										
	QOM1 Main Frame Size—Convertible to Main Lugs or Lower Amperage Main Circuit Breaker (See page 1-27)										
	100 A	8	16	8	HOM816M100PC	6-1	125	PK9GTA	5		
		12	24	12	HOM1224M100PC	6-2/0	125	PK15GTA	6		
		20	40	20	HOM2040M100PC	6-1	125	PK18GTA	7		
		24	48	24	HOM2448M100PC	6-2/0	125	PK23GTA	8		
		30	60	30	HOM3060M100PC	6-2/0	125	PK23GTA	10		
	125 A	24	48	24	HOM2448M125PC	6-2/0	6-1/0	PK23GTA	8		
		30	60	30	HOM3060M125PC		6-2/0	PK23GTA	10		
		Convertible Mains—Factory-installed Main Circuit Breaker									
	QOM2 Main Frame Size—Convertible to Main Lugs or Lower Amperage Main Circuit Breaker (See page 1-27)										
	150 A	30	60	30	HOM3060M150PC	4-250	225	PK23GTA	10		
		20	40	20	HOM2040M200PC		225	PK18GTA	9		
		30	60	30	HOM3060M200PC		225	PK23GTA	10		
		40	80	40	HOM4080M200PC		225	PK27GTA	12		
		42	84	42	HOM4284M200PC		225	PK27GTA	12		
		60	120	60	HOM60120M200PC		225	PK27GTA	25		
		42	84	42	HOM4284M225PC		4-300	4-250	225	PK27GTA	12
	Split Bus Plug-on Neutral Load Center—Manual Transfer for use with Temporary Backup Power Source Applications NEMA 1 (indoor)										
200 A	36	72	36	HOM1428X224M200PC	4-250	—	PK27GTA	12			

Above listings through 200 A mains rating meet Federal Specification W-P-115c as Type 1, Class 2.

1Ø, Field-Installed Mains Kits

Table 1.55: 1Ø Field Installed Main Lug Kits – Use with Convertible Main Load Centers Only



Field-Installed Main Type	Frame Size	Main [14] Ampere Rating	Use on Convertible Load Center with Mains Rating	Cat. No.	Lug Wire Size [15] AWG/kcmil
Main Lugs [16]	—	125 A	100–125 A	QOL125	6-2/0 Al or Cu
		125 A	100–125 A	QOL125VD	6-4/0 Al or Cu
		225 A	150–225 A	QOL225	6-300 Al or Cu
Main Circuit Breaker [17]	QOM1	50 A	100–125 A	QOM50VH	12-2/0 Al or Cu
		60 A	100–125 A	QOM60VH	
		70 A	100–125 A	QOM70VH	
		80 A	100–125 A	QOM80VH	
		90 A	100–125 A	QOM90VH	
		100 A	100–125 A	QOM100VH	
		110 A	125 A	QOM110VH	
		125 A	125 A	QOM125VH	
	QOM2 [18]	100 A	150–225 A	QOM2100VH	4-300 Al or Cu
		125 A	150–225 A	QOM2125VH	
		150 A	150–225 A	QOM2150VH	
		175 A	200–225 A	QOM2175VH	
		200 A	200–225 A	QOM2200VH	
		200 A	200–225 A	QOM2200VH	
		225 A	225 A	QOM2225VH	

[11] Maximum single pole branch circuits utilizing HOM and/or HOMET circuit breakers.
 [12] C at end of catalog number indicates combination flush/surface cover included with device.
 [13] See page 1-34
 [14] Do not exceed the load center mains rating.
 [15] Wire range listed for main device kits is the wire range of that device. To find out maximum wire size permitted in a particular load center per UL, see tables in page 1-8 and page 1-28 under Main Wire Size.
 [16] If main circuit breaker knockout has been removed from the load center's trim, order appropriate filler plate from page 1-29.
 [17] 22 k AIR main circuit breaker UL Listed for use ahead of HOM and HOMET 10 k AIR branch circuit breakers to permit their application on systems with up to 22 kA available fault current.
 [18] Add suffix 1021 for 120, 208, 240 Vac shunt trip.

HOM Plug-on Neutral Load Centers with Qwik-Grip
1Ø3W—120/240 Vac Indoor—UL Listed

The Square D Homeline plug-on neutral load centers with Qwik-Grip simplify rough-in by eliminating the need to remove knockouts, install wire connectors, and blindly pull wire into the load center. A quick bend of the wire using the wire bend guide on the Qwik-Grip insert and the wire slides into the slot. Once inserted, the Qwik-Grip shield snaps on to keep the wire behind the router for a secure, code-compliant installation.



HOM Plug-on Neutral Load Center with Qwik-Grip

Table 1.56: Plug-on Neutral Load Centers with Qwik-Grip (Compatible with HOM Plug-on Circuit Breakers and HOM Plug-on Neutral Circuit Breakers)

Main Ratings	Spaces	Max. 1P Circuits	Max. Tandem Circuit Breakers	Load Center Box, Interior and Cover	Main Wire Size AWG/kcmil		Bus Rating	Equipment Ground Bar Kit	Box No.
					Al	Cu			
125 A	24	48	24	HOM2448L125PQGC	6-2/0	6-1/0	125	PKGTALP2 Included	8Q
	30	60	30	HOM3060L125PQGC	6-2/0	6-2/0	125	PKGTALP2 Included	10Q
Convertible Mains—Factory-Installed Main Lugs, 10 kA Short Circuit Current Rating—QOM2 Main Frame Size, Convertible to Main Circuit Breaker									
225 A	30	60	30	HOM3060L225PQGC	4-250		225	PKGTALP2 Included	10Q
	40	80	40	HOM4080L225PQGC	4-250		225	PKGTALP3 Included	12Q
	42	84	42	HOM4284L225PQGC	4-250		225	PKGTALP3 Included	12Q
Convertible Mains—Factory-Installed Main Circuit Breaker, 22 kA Short Circuit Current Rating—QOM2 Main Circuit Breaker Frame Size, Convertible to Main Lugs or Main Circuit Breaker									
200 A	30	60	30	HOM3060M200PQC	4-250		225	PK23GTA (Order separately)	10Q
	40	80	40	HOM4080M200PQC	4-250		225	PK27GTA (Order separately)	12Q
	42	84	42	HOM4284M200PQC ^{Obs}	4-250		225	PK27GTA (Order separately)	12Q

^{Obs} This product is obsolete.

Homeline Service Upgrade Load Centers
1Ø3W—120/240 Vac Special Applications—UL Listed

Table 1.57: Service Upgrade Load Centers with Removable End Walls (Compatible with HOM Plug-on Circuit Breakers and HOM Plug-on Neutral Circuit Breakers)

Main Ratings	Spaces	Max. 1P Circuits [19]	Max. Tandem Circuit Breakers	Load Center Box and Interior	Extra Long Cover with Door (Order Separately)		Main Wire Size AWG / Kcmil		Bus Rating	Equipment Ground Bar Kit (Order Separately)	Box No. [20]
					Flush	Surface	Al	Cu			
Convertible Mains—Factory-Installed Main Circuit Breaker—22KA QOM2 Main Frame Size—Convertible to Main Lugs or Lower Amperage Main Circuit Breaker (See page 1-19)—Copper Bus [21]											
INDOOR	200 A	30	60	30	HOM3060M200PCEP ^{Obs} [22]	HOMC30UFL	—	4-250	225	PK23GTA	10

^{Obs} This product is obsolete.

[19] Maximum single pole branch circuits utilizing QO and/or QOT circuit breakers.

[20] See page 1-34

[21] 22 k AIR main circuit breaker UL Listed for use ahead of QO, QOT and QO-PL 10 k AIR branch circuit breakers to permit their application on systems with up to 22 kA available fault current.

[22] Ships with standard length cover.

HOM Standard Load Center Main Lugs, Fixed Mains
1Ø3W—120/240 Vac Rainproof—UL Listed

Table 1.58: Fixed Main Lugs Load Centers (Accepts Only HOM Plug-on Circuit Breakers - Not compatible with HOM Plug-on Neutral Circuit Breakers)

	Mains Rating	Spaces	Max. Single Pole Circuits [23]	Max. Tandem Circuit Breakers	Load Center Box, Interior and Cover	Main Wire Size AWG/kcmil		Bus Rating	Equipment Ground Bar Kit (Order Separately)	Box No. [24]	
					Cat. No. (DE3C)	Al	Cu		Cat. No. (DE3A)		
RAI N P R O O F	Main Lugs—10 kA Short Circuit Current Rating Factory-installed Fixed Main Lugs, 10 kA Short Circuit Current Rating										
	70 A	2	4	2	HOM24L70RB [25]	12–3	14–4	70	PK4GTA	1R	
	100 A	6	12	6	HOM612L100RB [26]	8–1		100	PK7GTA	2R	
	125 A	4	8	4	HOM48L125GRB	12–2/0	14–2/0	125	PK7GTA Included	15R	

Above listings through 200 A mains rating meet Federal Specification W-P-115c as Type 1, Class 2.

HOM Plug-on Neutral Load Center Main Lugs, Convertible Mains
1Ø3W—120/240 Vac Rainproof—UL Listed

Table 1.59: Convertible Main Lugs Plug-on Neutral Load Centers (Compatible with HOM Plug-on Circuit Breakers and HOM Plug-on Neutral Circuit Breakers)

	Mains Rating	Bus Rating	Spaces	Max. Single Pole Circuits [23]	Max. Tandem Circuit Breakers	Load Center Box, Interior and Cover	Main Wire Size AWG/kcmil		Bus Rating	Equipment Ground Bar Kit (Order Separately)	Box No. [24]
						Cat. No. (DE3C)	Al	Cu		Cat. No. (DE3A)	
RAI N P R O O F	Convertible Mains with Factory-installed Main Lugs [27], QOM1 Main Frame Size—Convertible to Main Circuit Breaker (See Below)										
	125 A	125	8	16	8	HOM816L125PRB	6–2/0	6–1	125	PK9GTA	3R
		125	12	24	12	HOM1224L125PRB			125	PK15GTA	3R
		125	20	40	20	HOM2040L125PRB			125	PK18GTA	4R
		125	24	48	24	HOM2448L125PRB			125	PK23GTA	6R
	Convertible Mains with Factory-installed Main Lugs [27], QOM2 Main Frame Size—Convertible to Main Circuit Breaker (See Below)										
	225 A	225	12	12	0	HOM12L225PRB	4–300	4–250	225	PK9GTA	5R
		225	16	32	16	HOM1632L225PRB OBS			225	PK15GTA	6R
		225	20	40	20	HOM2040L225PRB			225	PK18GTA	6R
		225	30	60	30	HOM3060L225PRB			225	PK23GTA	7R
		225	40	80	40	HOM4080L225PRB			225	PK27GTA	14R
		225	42	84	42	HOM4284L225PRB			225	PK27GTA	14R

Above listings through 200 A mains rating meet Federal Specification W-P-115c as Type 1, Class 2.

OBS This product is obsolete.

HOM Plug-on Neutral Load Center Main Breaker, Convertible Mains
1Ø3W—120/240 Vac Rainproof—UL Listed

Table 1.60: Convertible Main Breaker Plug-on Neutral Load Centers (Compatible with HOM Plug-on Circuit Breakers and HOM Plug-on Neutral Circuit Breakers)

	Mains Rating	Spaces	Max. Single Pole Circuits [23]	Max. Tandem Circuit Breakers	Load Center Box, Interior and Cover	Main Wire Size AWG/kcmil		Bus Rating	Equipment Ground Bar Kit (Order Separately)	Box No. [24]	
					Cat. No. (DE3C)	Al	Cu		Cat. No. (DE3A)		
RAI N P R O O F	Main Circuit Breaker—22 kA Short Circuit Current Rating Convertible Mains with Factory-Installed Main Circuit Breaker, QOM1 Main Frame Size—Convertible to Main Lugs or Lower Amperage Main Circuit Breaker (See Below) [28]										
	100 A	8	16	8	HOM816M100PRB	6–2/0	6–1	125	PK9GTA	3R	
		12	24	12	HOM1224M100PRB			125	PK15GTA	3R	
		20	40	20	HOM2040M100PRB			125	PK18GTA	4R	
	125 A	8	16	8	HOM816M125PRB OBS	6–2/0	6–1	125	PK9GTA	3R	
		24	48	24	HOM2448M125PRB			125	PK23GTA	6R	
	Convertible Mains with Factory-installed Main Circuit Breaker, QOM2 Main Frame Size—Convertible to Main Lugs or Lower Amperage Main Circuit Breaker (See Below)										
	150 A	30	60	30	HOM3060M150PRB	4–250	4–250	225	PK23GTA	7R	
		12	12	0	HOM12M200PRB			225	PK9GTA	5R	
		20	40	20	HOM2040M200PRB			225	PK18GTA	6R	
		30	60	30	HOM3060M200PRB			225	PK23GTA	7R	
		40	80	40	HOM4080M200PRB			225	PK27GTA	14R	
	Convertible Mains with Factory-installed Main Circuit Breaker with Feed-thru Lugs, QOM2 Main Frame Size—Convertible to Main Lugs or Lower Amperage Main Circuit Breaker (See Below) [27]										
	150 A	8	16	8	HOM816M150PFRB	4–250	4–250	150	PK15GTA	6R	
200 A	8	16	8	HOM816M200PFRB	4–250	4–250	225	PK15GTA	6R		

Above listings through 200 A mains rating meet Federal Specification W-P-115c as Type 1, Class 2.

OBS This product is obsolete.

[23] Maximum single pole branch circuits utilizing HOM and/or HOMT circuit breakers.

[24] See page 1-36

[25] HOM-GFI and HOM-AFI branch circuit breakers are limited to number 10 maximum wire.

[26] 70 A maximum branch circuit breaker, 100 A maximum back feed main circuit breaker.

[27] Side hinge door device allow 1-1/4 in. on left side for door to open.

[28] 22 k AIR main circuit breaker UL Listed for use ahead of HOM and HOMT 10 k AIR branch circuit breakers to permit their application on systems with up to 22 kA available fault current.

Plug-on Neutral Indoor Load Center Value Packs

Table 1.61: Plug-on Neutral Indoor Load Center Value Packs (Compatible with Plug-on and Plug-on Neutral Circuit Breakers)

Mains Rating	Spaces	Max. 1P Circuits [1]	Max. Tandem Circuit Breakers	Load Center Box, Interior, Cover and Branch Circuit Breakers		Equipment Ground Bar Kit (Order Separately) Cat. No.	Main Wire Size AWG/kcmil Al/Cu	Bus Rating	Box No. [2]	
				Cat. No.	Included Load Center/Circuit Breakers					
QO (Accepts Only QO Plug-On Circuit Breakers) QO—Copper Bus; Convertible Mains—Factory-Installed Main Circuit Breaker, 22 kA Short Circuit Current Rating Convertible appropriate to Main Lugs (See page 1-10) or QOM Main Circuit Breaker (See page 1-24)										
125 A	24	34	10	QO124L125PGCVP	(1) QO124L125PGC, (3) QO120, (2) QO230	PK15GTA Included	6-2/0	125	7	
225 A	42	52	10	QO142L225PGCVP OBS	(1) QO142L225PGC, (3) QO120, (2) QO230	PK23GTA Included	4-300	—	11	
Convertible Mains—Factory-Installed Main Circuit Breaker, 22 kA Short Circuit Current Rating Convertible appropriate to Main Lugs or Main Circuit Breaker (See page 1-27)										
100 A	24	34	10	QO124M100PCVP	(1) QO124M100PC, (3) QO120, (2) QO230	PK15GTA	6-2/0	125	7	
	32	38	6	QO132M100PCVP	(1) QO132M100PC, (3) QO120, (2) QO230	PK18GTA	6-2/0	125	8	
200 A	42	52	10	QO142M200PCVP	(1) QO142M200PC, (3) QO120, (2) QO230	PK23GTA	4-300	—	11	
	42	52	10	QO142M200PCAFVP OBS	(1) QO142M200PC, (3) QO120, (2) QO230, (3) QO115PCAFI	PK23GTA				
Homeline (Accepts Only HOM Plug-On Circuit Breakers); Convertible Mains—Factory-Installed Main Lugs, 10 kA Short Circuit Current Rating Convertible to appropriate QOM 22 kA Short Circuit Current Rating Main Circuit Breaker (See page 1-27)										
125 A	12	24	12	HOM1224L125PGCVP	(1) HOM1224L125PGC, (2) HOM120	PKGTLALP1 Included	6-2/0	6-1	125	6
225 A	30	60	30	HOM3060L225PGCVP	(1) HOM3060L225PGC, (3) HOM120, (2) HOM230	PKGTLALP2 Included	4-300	4-250	225	10
Convertible Mains—Factory-Installed Main Circuit Breaker, 22 kA Short Circuit Current Rating Convertible appropriate to Main Lugs or Main Circuit Breaker (See page 1-27)										
100 A	20	40	20	HOM2040M100PCVP	(1) HOM2040M100PC, (2) HOM120, (1) HOM230	PK18GTA	6-1	6-3	125	7
	20	40	20	HOM2040M100PC1AVP	(1) HOM2040M100PC, (2) HOM120, (1) HOM230, (1) HOM115PCAFI	PK18GTA	6-1	6-3	125	7
	24	48	24	HOM2448M100PCVP	(1) HOM2448M100PC, (3) HOM120, (2) HOM230	PK23GTA	6-2/0	6-1/0	125	8
200 A	30	30	30	HOM3060M150PCVP	(1) HOM3060M150PC, (3) HOM120, (2) HOM230	PK23GTA	4-250	—	225	10
	20	40	20	HOM2040M200PCVP	(1) HOM2040M200PC, (3) HOM120, (2) HOM230	PK18GTA				
	30	60	30	HOM3060M200PCVP	(1) HOM3060M200PC, (3) HOM120, (2) HOM230	PK23GTA				
	30	60	30	HOM3060M200PC1AVP	(1) HOM3060M200PC, (3) HOM120, (2) HOM230, (1) HOM115PCAFI	PK23GTA				
	30	60	30	HOM3060M200PCAFVP OBS	(1) HOM3060M200PC, (3) HOM120, (2) HOM230, (3) HOM115PCAFI	PK23GTA				
	40	80	40	HOM4080M200PCVP	(1) HOM4080M200PC, (3) HOM120, (2) HOM230	PK27GTA				
	40	80	40	HOM4080M200PC1AVP	(1) HOM4080M200PC, (3) HOM120, (2) HOM230, (1) HOM115PCAFI	PK27GTA				
	40	80	40	HOM4080M200PCAFVP	(1) HOM4080M200PC, (3) HOM120, (2) HOM230, (3) HOM115PCAFI	PK27GTA				

OBS This product is obsolete.

Table 1.62: Plug-on Neutral with Qwik-Grip Indoor Load Center Value Packs (Compatible with Plug-on and Plug-on Neutral Breakers)

Main Ratings	Spaces	Max. 1P Circuits	Max. Tandem Circuit Breakers	Load Center Box, Interior, Cover and Branch Circuit Breakers		Equipment Ground Bar Kit (Order Separately) Cat. No.	Main Wire Size AWG/kcmil Al/Cu	Bus Rating	Box No. [3]	
				Cat. No.	Included Load Center/Circuit Breakers					
QO Convertible Mains—Factory-Installed Main Lugs, up to 65 kA Short Circuit Current Rating—Copper Bus, QOM1 Main Frame Size, Convertible to Main Circuit Breaker										
125 A	24	34	10	QO124L125PQGCVP OBS	(1) QO124L125PQGC, (3) QO120, (2) QO230 and (1) PKQGA Qwik-Grip assembly kit	PK15GTAL Included	6-2/0	—	7Q	
QO Convertible Mains—Factory-Installed Main Circuit Breaker, 22 kA Short Circuit Current Rating—Copper Bus, QOM2 Main Frame Size, Convertible to Main Lugs or Main Circuit Breaker										
200 A	42	52	10	QO142M200PQCVP	(1) QO142M200PQC, (3) QO120, (2) QO230 and (1) PKQGA Qwik-Grip assembly kit	PK23GTA (Order separately)	4-250	225	11Q	
Homeline Convertible Mains—Factory-Installed Main Circuit Breaker, 22kA Short Circuit Current Rating—Copper Bus, QOM1 Main Frame Size, Convertible to Main Lugs or Main Circuit Breaker										
100 A	20	40	20	HOM2040M100PQCVP	(1) HOM2040M100PQC, (2) HOM120, (1) HOM230 and (1) PKQGA Qwik-Grip assembly kit	PK18GTA (Order separately)	6-2/0	6-1	125	7Q
200 A	30	60	30	HOM3060M200PQCVP	(1) HOM3060M200PQC, (3) HOM120, (2) HOM230 and (1) PKQGA Qwik-Grip assembly kit	PK23GTA (Order separately)	4-250	225	10Q	
	40	80	40	HOM4080M200PQCVP	(1) HOM4080M200PQC, (2) HOM120, (1) HOM230 and (1) PKQGA Qwik-Grip assembly kit	PK27GTA (Order separately)				

OBS This product is obsolete.

Table 1.63: Plug-on Neutral Rainproof Load Center Value Packs (Compatible with Plug-on and Plug-on Neutral Circuit Breakers)

Main Ratings	Spaces	Max. 1P Circuits	Max. Tandem Circuit Breakers	Load Center Box, Interior, Cover and Branch Circuit Breakers		Equipment Ground Bar Kit (Order Separately) Cat. No.	Main Wire Size AWG/kcmil Al/Cu	Bus Rating	Box No. [3]	
				Cat. No.	Included Load Center/Circuit Breakers					
Homeline (Accepts Only HOM Plug-On Circuit Breakers) Convertible Mains—Factory-Installed Main Circuit Breaker, 22 kA Short Circuit Current Rating Convertible to Main Lugs or Lower Amperage QOM2 Main Circuit Breaker (See page 1-27)										
125 A	12	24	12	HOM1224M125PRBVP	(1) HOM1224M125PRB, (3) HOM120, (2) HOM230	PK23GTA	6-2/0	6-1	125	3R
200 A	30	60	30	HOM3060M200PRBVP	(1) HOM3060M200PRB, (3) HOM120, (2) HOM230	PK23GTA	4-250	225	7R	

[1] Maximum single pole branch circuits utilizing QO and/or QOT circuit breakers.

[2] See page 1-34 or page 1-36

[3] See page 1-34

QO Load Center Accessories

Table 1.64: QO Load Center Accessories

Description		Cat. No.	Schedule	
Circuit Identification Stickers	Circuit identification stickers for use on cover directory labels to identify branch circuits	PSDS	DE5	
Cover Sealing Strap	Provides means of sealing trim mounting screws on QO load center covers	QO1SE	DE3A	
Door Lock Kits	Use with QO612L100DF/S, QO612L100DFCU/SCU, QO612L100DTF/S, QO816L100DF/S, QO816L100DFCU/SCU, QO816L100DTF/S, QO48M30DSGP, or QO48M60DSGP	PK8FL [4]	DE3A	
	Use with convertible mains, 1Ø and 3Ø 100–225 A, and fixed mains, 3Ø 125–225 A indoor load centers	PK6FL	DE3A	
	Use with 300 and 400 ampere indoor load centers	PK4FL	PE1A	
Filler Plates	Fills opening in covers if twistout is removed in error	QOFP	DE3A	
	Fills main circuit breaker opening in convertible load center covers 100–125 A	QOM1FP	DE3A	
	Fills main circuit breaker opening in convertible load center covers 150–225 A	QOM2FP	DE3A	
	Fills main circuit breaker opening in 3Ø load center covers (S01 and S02 Series)	KFP OBS	DE3A	
	Fills main circuit breaker opening in "Q" style 3Ø load center covers (S03 Series)	Q2FP	DE3A	
Ground Bar Kits	Ground Bar Assembly—3 connectors	PK3GTA1	DE3A	
	Ground Bar Assembly—4 connectors	PK4GTA	DE3A	
	Ground Bar Assembly—7 connectors	PK7GTA	DE3A	
	Ground Bar Assembly—12 connectors	PK12GTA	DE3A	
	Ground Bar Assembly—15 connectors	PK15GTA	DE3A	
	Ground Bar Assembly—18 connectors	PK18GTA	DE3A	
	Ground Bar Assembly—23 connectors	PK23GTA	DE3A	
	Ground Bar Assembly—27 connectors	PK27GTA	DE3A	
	Ground Bar Assembly—21 connectors. Use in high amperage load centers.	PK15GTA6	DE3A	
	Standard PK15GTA with a 1–4/0 Al/Cu Lug	PK15GTAL	DE3A	
	Standard PK18GTA with a 1–4/0 Al/Cu Lug	PK18GTAL	DE3A	
	Standard PK23GTA with a 1–4/0 Al/Cu Lug	PK23GTAL	DE3A	
	Ground Bar Pack—PK9GTA, PK9GTA, & LK100AN	PKGTALP1	DE3A	
	Ground Bar Pack—PK9GTA, PK18GTA, & LK100AN	PKGTALP2	DE3A	
	Ground Bar Pack—PK15GTA, PK18GTA, & LK100AN	PKGTALP3	DE3A	
Insulator Kit for PK7GTA through PK27GTA	PKGTAB	DE3A		
Handle Padlock Attachments	For padlocking main circuit breakers in convertible load centers OFF	50A–125A	QOM1PA	DE2E
	For padlocking main circuit breakers in convertible load centers OFF	100A–225A	QOM2PA	DE2E
Neutral Bonding Screw	For use on all Homeline and QO 125A convertible main load centers	4028344850K	DE5	
	For use on QO 150A–225A convertible main load centers	4028345850K	DE5	
Neutral / Ground Lugs	Field-installed for 12–2 Al or 14–4 Cu AWG wire	LK70AN	DE3A	
	Field-installed for 6–2/0 Al/Cu AWG wire	LK100AN	DE3A	
	Field-installed for 14–2/0 Al/Cu AWG wire	LK125AN	DE3A	
	Field-installed for 2–3/0 Al/Cu AWG wire	LK150AN	DE3A	
	Field-installed for 4 AWG to 300 kcmil Al/Cu wire. Use in Series S, 150–225A QO load center or S03 and below, 150–225A HOM load center	LK225AN	DE3A	
Replacement Cover Directory Label	1 through 42 numbered universal replacement directory label for load center covers	LSDL	DE5	
Retaining Kit for Breakers Used as Back-fed Mains	Secures circuit breaker to interior when used as a back-fed main. For QO612L100F/S, RB, QO612L100DF/S, QO816L100F/S, RB, QO816L100DF/S and QO148L125GF/S, GRB load centers	PK2MB	DE3A	
	Secures 3P circuit breaker without accessories to left side of interior when used as a back-fed main. For 3Ø load centers	PK3MB	DE3A	
	Secures circuit breaker to interior when used as a back-fed main for 2P QO 150–200 A circuit breakers	PK5RK OBS	DE3A	
	Secures ONE circuit breaker with or without electrical accessories to right side of interior when used as a back-fed main For 1Ø 100–125 ampere convertible main load centers. Series S01 and S02	PK4MB2LA	DE3A	
	Secures ONE circuit breaker with or without electrical accessories to right side of interior when used as a back-fed main For 1Ø 150–225 ampere convertible main load centers. Series S01 and S02	PK4MB2HA	DE3A	
Service Entrance Barriers	QO / Homeline 1Ø 100–125 A QOM1 convertible main load centers	PKSB1LA	DE3A	
	QO / Homeline 1Ø 150–225 A QOM2 convertible main load centers	PKSB1HA	DE3A	
	QO 3Ø convertible main load centers	PKSB3	DE3A	
	QO 1Ø back-fed main breaker applications	PKSB1QOBF	DE3A	
	QO 3Ø back-fed main breaker applications	PKSB3BF	DE3A	
QO Load Center Manual Power Transfer Accessories				
Generator Circuit Breaker Interlock Kit	For use on "G" and "S" Series NEMA 1 and "G", "S1" and "S2" Series NEMA 3R load centers. Interlocks a QOM1 2P main circuit breaker of a load center (100–125 A) with a QO 2P (15–125 A) branch circuit breaker. Includes a retaining kit.	QOCRBGK1C	DE3A	
	For use on "G" and "S" Series NEMA 1 and "G" and "S1" Series NEMA 3R load centers. Interlocks a QOM2 2P main circuit breaker of a load center (150–225 A) with a QO 2P (15–125 A) branch circuit breaker. Includes a retaining kit.	QOCGK2C	DE3A	
	For use on "S2" Series NEMA 3R load centers. Interlocks a QOM2 2P main circuit breaker of a load center (150–225 A) with a QO 2P (15–125 A) branch circuit breaker. Includes a retaining kit.	QORBGK2C	DE3A	
Manual Transfer Equipment Kit	For interlocking the handles of two 2P or one 2P and one 1P QO and Q1 circuit breakers mounted side-by-side so that only one circuit breaker can be "ON" at a time.	QO2DTI	DE2E	
	QO2DTI mechanical interlock attachment with retaining kits for securing two adjacent back-fed circuit breakers in dual power supply applications. Can be used with (2) 2P or (1) 2P and (1) 1P QO circuit breakers in QO816L100 load centers.	QO2DTIM	DE2E	
	Secures two 2P circuit breakers to right side of interior when used as back-fed mains, a QO2DTI Kit included for back-up power supply applications. For 1Ø 100–125 ampere convertible main load centers. Series S01 and S02.	PK4DTIM4LA	DE3A	
	Secures two 2P circuit breakers to right side of interior when used as back-fed mains, a QO2DTI Kit included for back-up power supply applications. For 1Ø 150–225 ampere convertible main load centers. Series S01 and S02.	PK4DTIM4HA	DE3A	
	Secures two 2P circuit breakers to left side of interior when used as back-fed mains, a QO2DTI Kit included for back-up power supply applications. For 1Ø 100–125 ampere convertible main load centers. Series S01 and S02.	PK4DTIM4LAL	DE3A	

OBS This product is obsolete.

[4] QO403L60NF/S does not have provisions for a field-installed lock.

Table 1.65: QO Load Center Accessories

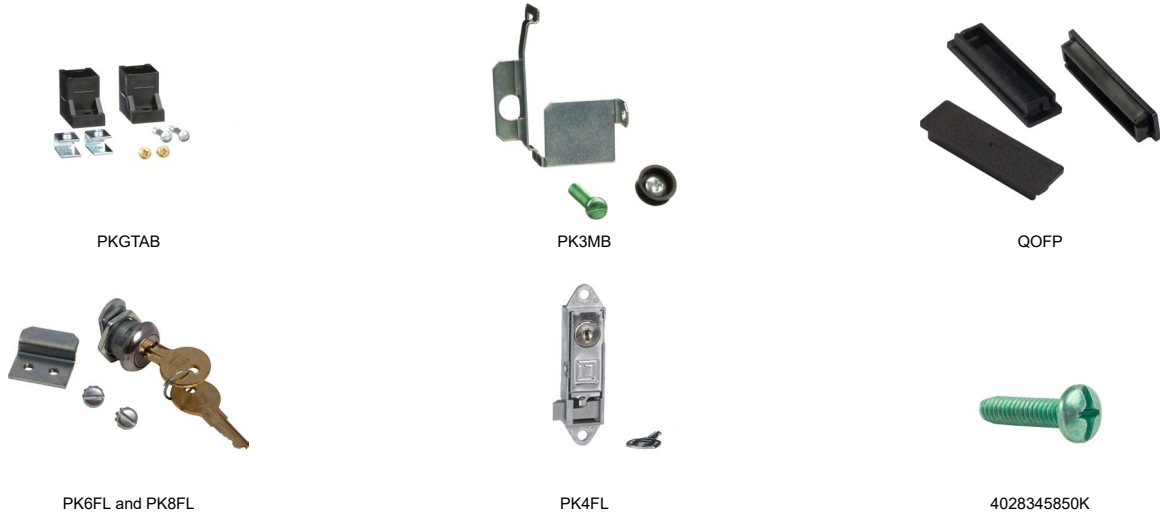

Table 1.66: QO Load Center Covers

Mains Rating	Spaces	QO Standard Covers			QO Mono-Flat Covers	
		Flush	Surface	Flush	Gray Covers	White Covers
		Gray Covers		White Covers	Gray Covers	White Covers
QO 1 Phase Load Center Covers — Convertible Mains						
100 A	12	QOC12UF	QOC12US	—	—	—
	16	QOC20U100F	QOC20U100S	—	—	—
	20	QOC20U100F	QOC20U100S	—	—	—
	24	QOC24UF	QOC24US	QOC24UFW	—	—
125 A	32	QOC32UF	—	QOC32UFW	—	—
	12	QOC16UF	QOC16US	QOC16UFW	—	—
	16	QOC24UF	QOC24US	QOC24UFW	—	—
	20	QOC20U100F	QOC20U100S	—	—	—
	24	QOC24UF	QOC24US	QOC24UFW	—	—
	30	QOC30U125C	—	—	—	—
150 A	32	QOC32UF	—	QOC32UFW	—	—
	20	QOC30UF	QOC30US	QOC30UFW	QOCMF30UC	QOCMF30UCW
	24	QOC30UF	QOC30US	QOC30UFW	QOCMF30UC	QOCMF30UCW
	30	QOC30UF	QOC30US	QOC30UFW	QOCMF30UC	QOCMF30UCW
200 A	32	QOC40UF	QOC40US	QOC40UFW	—	—
	12	QOC30UF	QOC30US	QOC30UFW	QOCMF30UC	QOCMF30UCW
	20	QOC30UF	QOC30US	QOC30UFW	QOCMF30UC	QOCMF30UCW
	24	QOC30UF	QOC30US	QOC30UFW	QOCMF30UC	QOCMF30UCW
	30	QOC30UF	QOC30US	QOC30UFW	QOCMF30UC	QOCMF30UCW
	40	QOC40UF	QOC40US	QOC40UFW	—	—
	42	QOC42UF	QOC42US	QOC42UFW	QOCMF42UC	QOCMF42UCW
225 A	54	QOC54UF	—	QOC54UFW	QOCMF54UC	QOCMF54UCW
	60	—	—	—	QOCMF60UC	QOCMF60UCW
	40	QOC42UF	QOC42US	QOC42UFW	QOCMF42UC	QOCMF42UCW
	42	QOC42UF	QOC42US	QOC42UFW	QOCMF42UC	QOCMF42UCW
	54	QOC54UF	—	QOC54UFW	QOCMF54UC	QOCMF54UCW
QO Rise Panel (Wide Gutter) Covers						
125 A	12	QOC20UFWGW	—	QOC20UFWGW	NQC20FWG ^[5]	NQC20FWGW
	20	QOC20UFWGW	—	QOC20UFWGW	NQC20FWG	NQC20FWGW
200 A	24	QOC30UFWGW	—	QOC30UFWGW	NQC30FWG ^{Obs}	NQC30FWGW
	30	QOC30UFWGW	—	QOC30UFWGW	NQC30FWG	NQC30FWGW
QO 3-Phase Load Center Covers — Fixed Mains						
125 A	12	QOC16UF	QOC16US	QOC16UFW	—	—
	20	QOC24UF	QOC24US	QOC24UFW	—	—
	24	QOC24UF	QOC24US	QOC24UFW	—	—
200 A	18	QOC30UF	QOC30US	QOC30UFW	—	—
	30	QOC30UF	QOC30US	QOC30UFW	—	—
225 A	42	QOC42UF	QOC42US	QOC42UFW	—	—
QO 3-Phase Load Center Covers — Convertible Mains						
100 A	27	QOC30UF	QOC30US	QOC30UFW	—	—
125 A	30	QOC342MQF	QOC342MQS	—	—	—
150 A	30	QOC342MQF	QOC342MQS	—	—	—
	42	QOC342MQF	QOC342MQS	—	—	—
200 A	30	QOC342MQF	QOC342MQS	—	—	—
	42	QOC342MQF	QOC342MQS	—	—	—
225 A	42	QOC342MQF	QOC342MQS	—	—	—

^{Obs} This product is obsolete.

Table 1.67: QO Load Center Covers



Table 1.68: Homeline Load Center Accessories

Description		Cat. No.	Schedule	
Circuit Identification Stickers	Circuit identification stickers for use on cover directory labels to identify branch circuits	PSDS	DE5	
Door Lock Kit	Use with convertible indoor load center covers (Series S-1)	PK6FL	DE3A	
Filler Plates	Fills opening in covers if twistout is removed in error	HOMFP	DE3C	
	Fills main circuit breaker opening in convertible load centers	100–125 A	QOM1FP	DE3A
		150–225 A	QOM2FP	DE3A
Generator Circuit Breaker Interlock Kit	For use on "S" Series NEMA 1 and NEMA 3R load centers. Interlocks a QOM1 2P main circuit breaker of a load center (100–125 A) with a Homeline 2P (15–125 A) branch circuit breaker	HOMCRBGK1C	DE3D	
	For use on "S" Series NEMA 1 and "S1" Series NEMA 3R load centers. Interlocks a QOM2 2P main circuit breaker of a load center (150–225 A) with a Homeline 2P (15–125 A) branch circuit breaker	HOMCGK2C	DE3D	
	For use on "S2" and "S3" Series NEMA 3R QOM2 load centers. Interlocks a QOM2 2P main circuit breaker of a load center (150–225 A) with a Homeline 2P (15–125 A) branch circuit breaker	HOMRBGK2C	DE3D	
Ground Bar Kits	Ground Bar Assembly - 3 connectors	PK3GTA1	DE3A	
	Ground Bar Assembly - 4 connectors	PK4GTA1	DE3A	
	Ground Bar Assembly - 7 connectors	PK7GTA1	DE3A	
	Ground Bar Assembly - 9 connectors	PK9GTA1 ^{obs}	DE3A	
	Ground Bar Assembly - 15 connectors	PK15GTA1	DE3A	
	Ground Bar Assembly - 19 connectors	PK18GTA1	DE3A	
	Ground Bar Assembly - 23 connectors	PK23GTA1	DE3A	
	Ground Bar Assembly - 27 connectors	PK27GTA1	DE3A	
	Standard PK15GTA with a 1–4/0 Al/Cu Lug	PK15GTA	DE3A	
	Standard PK18GTA with a 1–4/0 Al/Cu Lug	PK18GTAL	DE3A	
	Ground Bar Pack - PK9GTA, PK9GTA & Lug	PKGTALP1	DE3A	
	Ground Bar Pack - PK9GTA, PK18GTA & Lug	PKGTALP2	DE3A	
	Ground Bar Pack - PK15GTA, PK18GTA & Lug	PKGTALP3	DE3A	
	Insulator Kit for PK7GTA through PK27GTA	PKGTAB	DE3A	
Handle Padlock Attachment	For padlocking main circuit breakers in convertible load center, "OFF"	50–125 A	QOM1PA	DE2E
		100–225 A	QOM2PA	DE2E
Neutral Bonding Screw	For use on all Homeline and QO 125A convertible main load centers	4028344850K	DE5	
	For use on QO 150A-225A convertible main load centers	4028345850K	DE5	
Neutral / Ground Lugs	Field-installed for 14–2 AWG Al or 14–4 AWG Cu wire	LK70AN	DE3B	
	Field-installed for 6–2/0 AWG Al/Cu wire	LK100AN	DE3B	
	Field-installed for 14–2/0 AWG Al/Cu wire	LK125AN	DE3B	
	Field-installed for 4 AWG to 300 kcmil Al/Cu wire. Use in Series S, 150-225A QO load center or S03 and below, 150-225A HOM load center	LK225AN	DE3A	
	Field-installed for 4 AWG–300 kcmil Al/Cu wire. Use in Series S04, 150–225 A HOM load center	LK225ANHOM ^{obs}	DE3A	
Replacement Cover Directory Label	1 through 42 numbered universal replacement directory label for load center covers	LSDL	DE5	
Retaining Kit for Breakers Used as Back-fed Mains	Secures circuit breaker to interior when used as a back-fed main. For HOM612L100F/S, RB and HOM48L125GC, GRB load centers	HOM1RK	DE3C	
	Secures ONE circuit breaker right side of interior when used as a back-fed main For 100–125 A convertible main load centers, Series S01 and S02	HOM4RK2LA	DE3C	
	Secures ONE circuit breaker right side of interior when used as a back-fed main For 150–225 A convertible main load centers, Series S01 and S02	HOM4RK2HA ^{obs}	DE3C	
	Secures circuit breaker to interior when used as a back-fed main For 2P 150–200 A circuit breakers	HOM5RK	DE3C	
Service Entrance Barriers	QO / Homeline 1Ø 100–125 A QOM1 convertible main load centers	PKSB1LA	DE3A	
	QO / Homeline 1Ø 150–225 A QOM2 convertible main load centers	PKSB1HA	DE3A	
	Homeline back-fed main breaker applications	PKSB1HOMBF	DE3A	

^{obs} This product is obsolete.

Table 1.69: Homeline Load Center Replacement Covers



Mains Rating	Spacers	Homeline Standard Covers		Homeline Mono Flat Covers
		Combination Gray	Combination White	Gray
100 A	8	HOMC8UC ^{obs}	—	—
	12	HOMC12UC ^{obs}	HOMC12UCW ^{obs}	—
	24	HOMC24UC	HOMC24UCW	—
125 A	8	HOMC12UC	HOMC12UCW	—
	16	HOMC24UC	HOMC24UCW	—
	20	HOMC24UC	HOMC24UCW	—
	24	HOMC24UC	HOMC24UCW	—
150 A	16	HOMC20UC	HOMC20UCW	—
	20	HOMC20UC	HOMC20UCW	—
	30	HOMC30UC	HOMC30UCW	—

Table 1.69 Homeline Load Center Replacement Covers (cont'd.)

Mains Rating	Spacers	Homeline Standard Covers		Homeline Mono Flat Covers
		Combination	Combination	Gray
		Gray	White	
200 A	12	HOMC20UC	HOMC20UCW	—
	16	HOMC20UC	HOMC20UCW	—
	20	HOMC20UC	HOMC20UCW	—
	30	HOMC30UC [6]	HOMC30UCW	—
	40	HOMC42UC	—	—
	42	HOMC42UC	—	—
	60	HOMC60UC	—	HOMCMF60UC
225 A	16	HOMC20UC	HOMC20UCW	—
	20	HOMC20UC	HOMC20UCW	—
	30	HOMC30UC	HOMC30UCW	—
	40	HOMC42UC	—	—
	42	HOMC42UC	—	—
	60	HOMC60UC ^{OBS}	—	HOMCMF60UC

^{OBS} This product is obsolete.

QO and Homeline Qwik-Grip Load Center Accessories

Table 1.70: Qwik-Grip Load Center Accessories

Description		Cat. No.	Schedule
Qwik-Grip replacement shield	(1) Qwik-Grip shield	PKQGS	DE3A
Qwik-Grip fillers	(4) Qwik-Grip fillers	PKQGFP	DE3A
Qwik-Grip replacement insert	(1) Qwik-Grip insert	PKQGI	DE3A
Qwik-Grip assembly kit	(4) Qwik-Grip shields, (4) Qwik-Grip fillers	PKQGA	DE3A

[6] Extra long version available HOMC30UFL

Surge Protective Devices (SPD)

Table 1.71: Load Center and CSED Surge Protection Devices

Description	Cat. No.	Description	Surge Current per Phase	Schedule
Surge Protective Devices	QO2175SB	QO Surgebreaker	22.5 kA	DE1B
	HOM2175SB	HOM Surgebreaker	22.5 kA	DE1B
	HEPD25	1Ø3W—120/240 V Compact SPD	25 kA	DE1B
	SDSA2040	3Ø4W—208Y/120 V Compact SPD	40 kA	DE1B
	SDSA2040D	3Ø3W—240 V Compact SPD	40 kA	DE1B
	QO250PSPD	QO Plug-on Neutral SPD	50 kA	DE1B
	HOM250PSPD	HOM Plug-on Neutral SPD	50 kA	DE1B
	HEPD50	SurgeArrest Whole Home Electronic Protection	50 kA	DE1B
	HEPD80	SurgeArrest Whole Home Electronic Protection	80 kA	DE1B
	SDSB80111 OBS	Surgebreaker Plus (all-in-one protection for appliances, ethernet, and telephone)	80 kA	DE1B
Surge Protective Device Mounting Kits	HEPD25MKF	HEPD25 Flush Mount Kit	—	DE1B
	HEPD58MKF	HEPD50 and HEPD80 Flush Mount Kit	—	DE1B

OBS This product is obsolete.



HEPD25



HEPD50



HEPD80



QO250PSPD



HOM250PSPD



QO2175SB



HOM2175SB

Indoor Enclosure Dimensions and Knockout Information

Table 1.72: Enclosure Dimensions

Box No.	Dimensions					
	W		H		D	
	in.	mm	in.	mm	in.	mm
1	3.81	97	6.72	171	3.00	76
2	4.81	122	9.30	236	3.19	81
3	4.81	122	9.30	236	3.19	81
4	8.88	226	12.57	319	3.80	97
5	14.25	362	14.92	379	3.75	95
6	14.25	362	17.92	455	3.75	95
7	14.25	362	20.92	531	3.75	95
8	14.25	362	26.04	661	3.75	95
9	14.25	362	29.86	758	3.75	95
10	14.25	362	33.78	858	3.75	95
11	14.25	362	37.98	965	3.75	95
12	14.25	362	39.37	1000	3.75	95

Table 1.73: Knockout Information

Symbol	Knockouts								
	A	B	C	D	E	F	G	H	I
Conduit Size	1/2	3/4	1	1-1/4	1-1/2	2	2-1/2	3	3-1/2

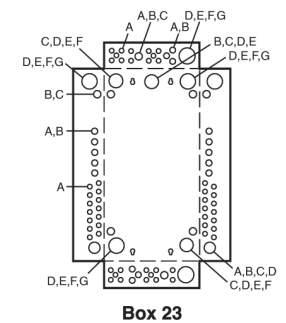
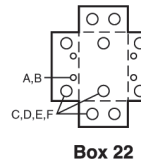
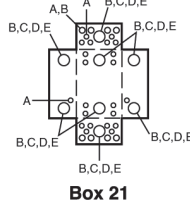
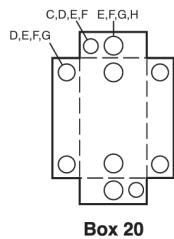
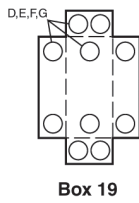
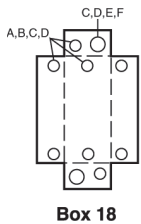
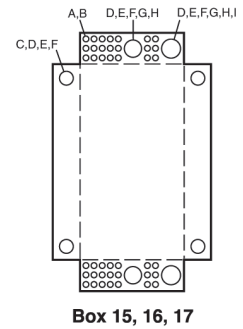
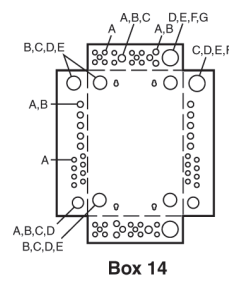
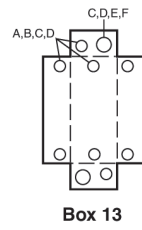
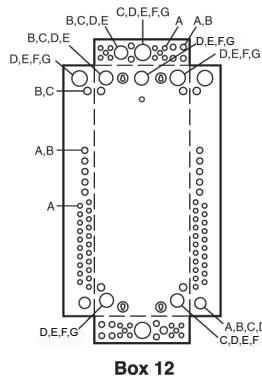
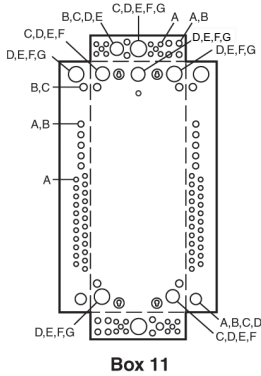
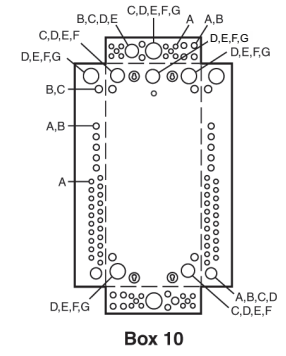
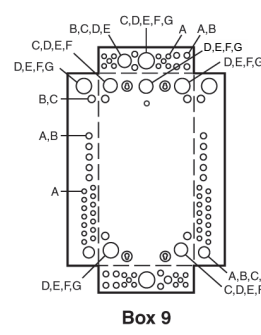
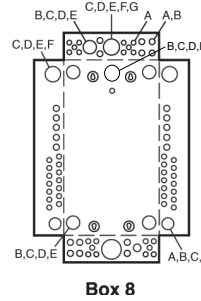
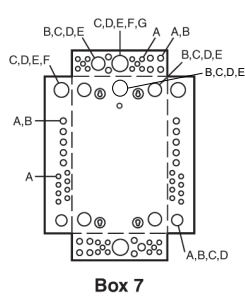
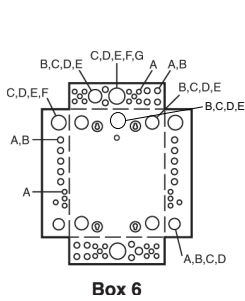
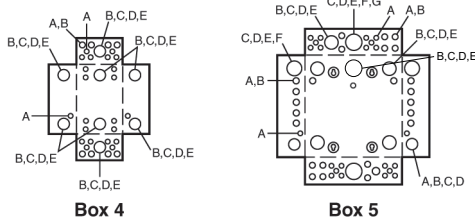
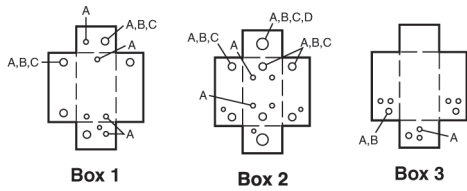
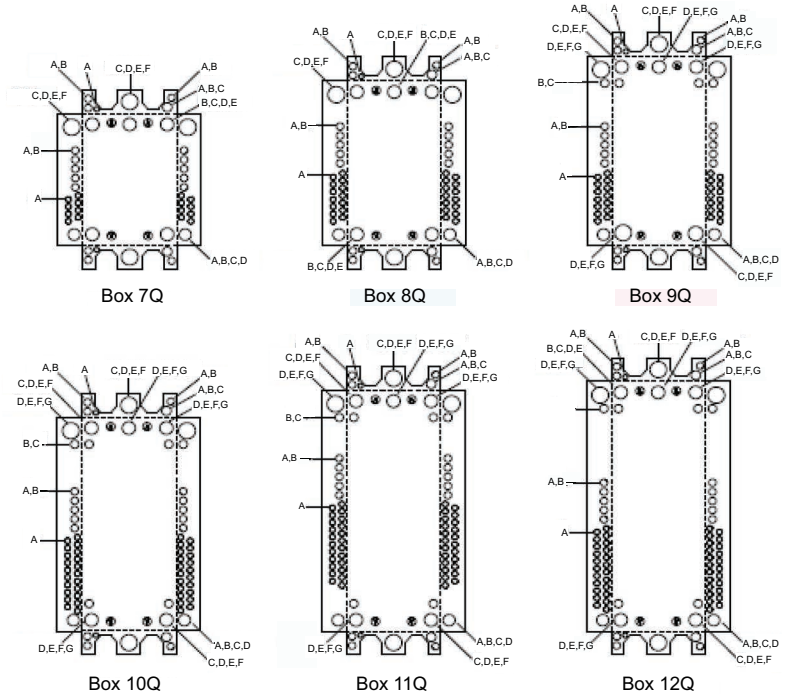
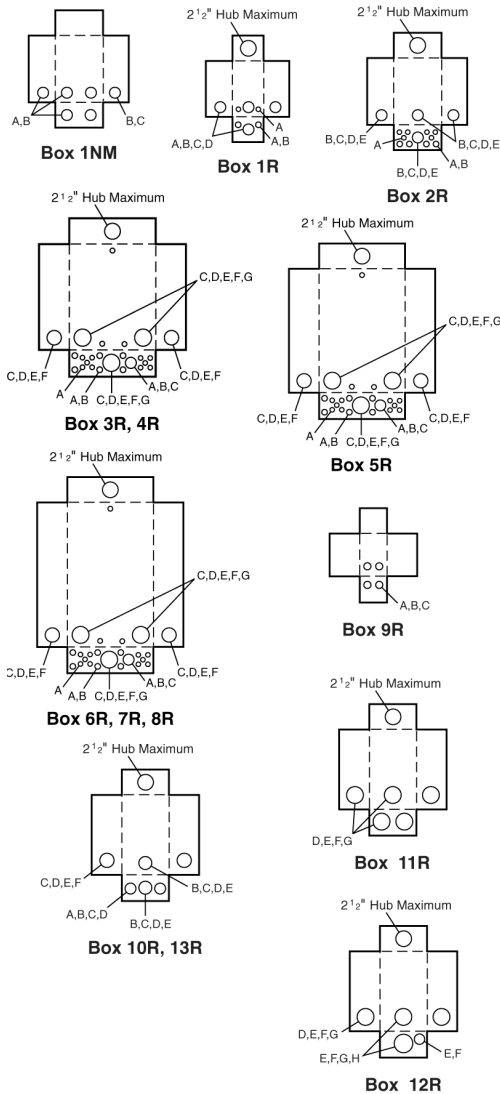

Table 1.74: Indoor Knockout Information and Enclosure Dimensions for Qwik Grip Loadcenters

Box No.	Dimensions					
	W		H		D	
	in.	mm	in.	mm	in.	mm
7Q	14.25	362	20.92	531	3.75	95
8Q	14.25	362	26.04	661	3.75	95
9Q	14.25	362	29.86	758	3.75	95
10Q	14.25	362	33.78	858	3.75	95
11Q	14.25	362	37.98	965	3.75	95
12Q	14.25	362	39.37	1000	3.75	95





Enclosure Dimensions and Knockout Information

Table 1.75: Enclosure Dimensions

Box No.	Dimensions					
	W		H		D	
	in.	mm	in.	mm	in.	mm
1NM	6.52	166	8.79	223	3.90	99
1R [1]	4.88	124	9.38	238	4.00	102
2R	8.88	226	12.65	321	4.27	108
3R	14.75	375	18.92	481	4.52	115
4R	14.75	375	22.06	560	4.52	115
5R	14.75	375	26.04	661	4.52	115
6R	14.75	375	29.86	758	4.52	115
7R	14.75	375	33.78	858	4.52	115
8R	14.75	375	37.98	965	4.52	115
9R	4.56	116	6.50	165	3.88	99
10R	6.92	176	13.18	335	4.12	105
11R	7.56	192	23.24	590	4.75	121
12R	9.62	244	26.24	666	5.50	140
13R	6.92	176	16.18	411	4.12	105
14R	14.75	375	39.37	1000	4.52	115
15R	8.88	226	14.80	376	4.27	108
16R	8.55	217	24.75	629	4.16	106
17R	8.88	226	12.65	321	4.27	108

Table 1.76: Knockout Information

Symbol	Knockouts							
	A	B	C	D	E	F	G	H
Conduit Size	1/2 in.	3/4 in.	1 in.	1-1/4 in.	1-1/2 in.	2 in.	2-1/2 in.	3 in.

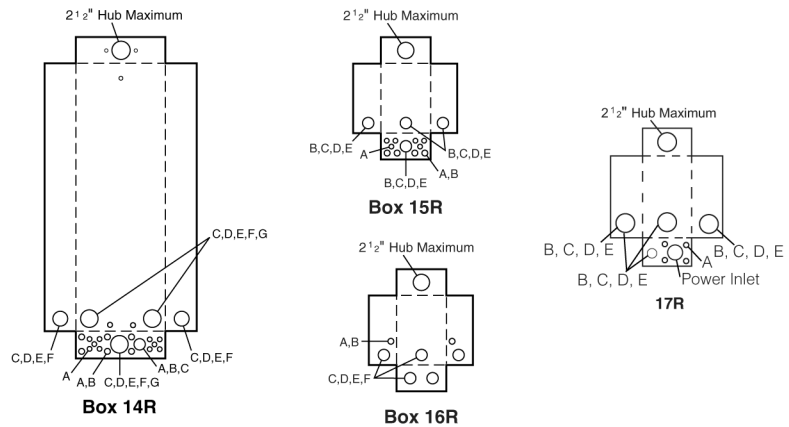

Bolt-On Hubs

Square D equipment with "R" or "RB" suffix, designated NEMA 3R rainproof construction, utilizes bolt-on hubs listed below. "RB" devices will accept 3/4 in. through 2-1/2 in. bolt-on hubs without the use of reducers. Off-center conduit thread openings and elongated mounting holes provide quick and easy adjustment to eliminate costly conduit offsets and bends. Catalog suffix "R" devices require 3 in. through 4 in. field cut opening. Hubs are suitable for use with conduit having ANSI standard taper pipe thread.

Table 1.77: Bolt-On Hubs UL Listed for Rainproof Devices

Conduit Size	3/4 in.	1 in.	1-1/4 in.	1-1/2 in.	2 in.	2-1/2 in.
Hub Cat. No.	B075	B100	B125	B150	B200	B250

NOTE: Closing cap (Cat. No. BCAP) is provided factory-installed on each device having "RB" suffix.

Table 1.78: Bolt-On Hubs UL Listed for Mounting in Field-Cut Opening

Conduit Size	3 in.	4 in.
Hub Cat. No.	B300	B400
	Designed for mounting in field cut opening. Includes gasket and four mounting bolts and nuts.	

[1] HOME250SPA and QO260NATR top endwall has no hub opening.

Catalog Number Logic for CSED

Table 1.79: Catalog Numbers for Combination Service Entrance Devices

Number Segment	Character	Description	R	Q	C	8	16	D	200	C	H	X	S
Socket Type	Q	QO Ringless											
	R	HOM Ringless											
	C	QO Ring type											
	S	HOM Ring type											
Service Disconnect Install	Blank	Field Installed											
	Q	Factory Installed											
Service Feed	Blank	Combination overhead/underground											
	C	Combination overhead/underground											
	O	Overhead only											
	U	Underground only											
	RA	"A" Hub provision in top endwall											
Spaces (Service Discounts or Branches)	#	Maximum # of 1-pole circuits											
	#	Maximum # of 1-pole spaces											
Interior	D	Dual main service disconnects (feed-thru lugs on meter mains only)											
	F	Single main service disconnect with feed-thru lugs											
	L	Main lug interior (service disconnects field installed)											
	M	Single main service disconnect											
Amperage Rating	100	100 A											
	125	125 A											
	150	150 A											
	200	200 A											
	225	225 A											
	400	400 A											
Enclosure Mounting Style	C	Surface mount or convertible to semi-flush (use appropriate flange kit)											
	F	Semi-flush mount only											
	R	Reverse mount only											
	S	Surface mount only											
	PF	Home PoN semi-flush mount device											
	PS	Home PoN surface mount device											
Meter Socket Bypass Type	H	Horn by-pass											
	K	K-4 bolt-on, no by-pass											
	L	Class 320 with lever by-pass											
	N	Class 320, No by-pass											
	B	Class 320 Manual by-pass											
	Blank	No by-pass											
	X	2 piece lever by-pass cover											
Application	S	Solar ready											
	FMG	Florida Meter Group											
	MEG	Meter Equipment Group											

This table is for interpreting existing part number only. All possible combinations are not available.

Table 1.80: Catalog Numbers Square D™ Energy Center

Number Segment	Character	Description	QO	W	C	60	M	200	P	F	Y
Architecture platform	QO	QO architecture platform									
Wiser Energy	W	Wiser Energy									
Socket Type	C	QO Ringless									
Spaces	#	Number of Spaces									
Interior	M	Single main service disconnect									
Amperage Rating	200	200 A									
Plug-on-neutral	P	Plug-on-neutral ready									
Enclosure mounting style	F	Semi-flush mount only									
Application	Y	Universal — compatible with any solar inverter									

Rainproof Meter Mains

Table 1.81: Rainproof Meter Mains

Ampere Rating	Bypass Type	Service (Type of Feed)		Short Circuit Current Rating	Cat. No.	Service Disconnect(s)			Load Center and Branch Circuit Breakers (Order separately [1])				Hub Type (Order separately [2])	Line Side Main Lugs AWG/kcmil (Al/Cu)	Service Ground Lug AWG/kcmil (Al/Cu)	Bus Rating	Weight Each (Lbs) and Pallet Qty.					
		UL	UL and EUSERC			2P Circuits (Max.)	Type (Order separately [3])	Ampere Rating Max.	Max. Quantity		Ampere Rating Max.											
									Spaces	1P Circuits		Tandems										
Ring Type, QO™																						
Surface Mount Only																						
125 A	None	OH/UG	—	10 kA	C125RB	1	QOM1-VH	125 A	—	—	—	—	B	4-1/0	8-1/0	—	15, 54					
		OH/UG	—	22 kA	CM200S	1	QOM2-VH	200 A	—	—	—	—	A	4-250	(2)8-2/0	—	26, 24					
200 A	None	OH/UG	—	22 kA	C2M200S OBS	1	QOM2-VH	200 A	—	—	—	—	A	4-250	(2)8-2/0	—	27, 20					
		OH/UG	—	10 kA	C4L200S OBS	2	QO	100 A	—	—	—	—	A	4-250	(2)8-2/0	—	27, 28					
Ring Type, Homeline™																						
Surface Mount Only																						
125 A	None	OH/UG	OH/UG	10 kA	SC8L125S	4	HOM	125 A	—	—	—	—	A	6-2/0	6-2/0	125	31, 24					
200 A	None	OH/UG	OH/UG	10 kA	SC12L200S OBS	6	HOM	200 A [4]	—	—	—	—	A-L	4-250	8-2/0	200	40, 10					
Semiflush Mount only																						
125 A	None	OH/UG	OH/UG	10 kA	SC8L125F OBS	4	HOM	110 A	—	—	—	—	A or B300	6-2/0	6-2/0	—	37, 20					
200 A	None	OH [5]/UG	OH [5]/UG	10 kA	SC12L200F OBS	6	HOM	200 A [6]	—	—	—	—	A-L	4-250	8-2/0	225	47, 10					
Surface Mount—Supplied with Feed-Thru Lugs and provisions for Branch Circuit Breakers																						
150 A	None	OH/UG	—	10 kA	SC816D150C [7] [8]	1	HOM2150 [9]	150 A	8	16	8	100 A [10]	A or A-L	6-300	8-1/0	200	48, 18					
			UG		SU816D150C [7] [8] OBS	1										50 A		—	—	—	—	—
200 A	None	UG	—	10 kA	SC816D200C [7] [8]	1	HOM2200 [9]	200 A	8	16	8	100 A [10]	A or A-L	6-300	8-1/0	200	48, 18					
			UG		SU816D200C OBS	1										50 A		—	—	—	—	—
Ringless, QO™																						
Surface Mount Only																						
200 A	None	OH/UG	—	10 kA	RC200S [11]	1	QOM2-VH	200 A	—	—	—	—	A	6-350	(2)8-2/0	—	26, 24					
	Lever				RCM200SL [11] [12]	1	QOM2-VH	200 A										A	6-350	8-1/0	—	60 / 14
	None				RC2M200S [11]	1	QOM2-VH	200 A										A	6-350	(2)8-2/0	—	27, 20
	Horn				RC2M200SH OBS [11]	1	QOM2-VH	50 A										A	6-350	(2)8-2/0	—	27, 20
	Lever				RC2M200SL OBS [11]	1	QOM2-VH	200 A										A	6-350	8-1/0	—	60 / 14
					[12]	1	QO-VH	50 A												8-1/0		
	None				QC12L200S OBS [11]	6	QO-VH	200 A										A	6-350	8-2/0	—	43, 21
	None				[12]	6	QO-VH	200 A										A	6-350	12-2/0	200	40, 21
	[6]																					
Surface Mount Only, Supplied with Feed-Thru Lugs and provisions for Branch Circuit Breakers																						
100 A	Horn	OH/UG	—	22 kA	QC816F100CH [7] [11] [12]	1	QOM2100VH [9]	100 A	8	16	8	100	A	6-350	12-2/0	200	40, 21					
125 A	None	OH/UG	—	22 kA	QC816F125S OBS	1	QOM2125VH [9]	125 A	8	16	8	100	A	6-350	8-2/0	—	43, 21					
	None	OH/UG	—	22 kA	QC816F125C [7] [11]	1	QOM2125VH [9]	125 A	8	16	8	100	A	6-350	12-2/0	125	40, 21					
150 A	None	OH/UG	—	22 kA	QC816F150S [7] [11] [12]	1	QOM2150VH [9]	150 A	8	16	8	150 A [13]	A	6-350	8-2/0	200	43, 21					
	None	OH/UG	—	22 kA	QC816F150C [7] [11]	1	QOM2150VH [9]	150 A	8	16	8	150 A [13]	A	6-350	12-2/0	200	40, 21					
	Lever	OH/UG	—	22 kA	QC816F150SL OBS [7] [11] [12]	1	QOM2150VH [9]	200 A	8	16	8	150 A	A	6-350	8-2/0	—	74 / 12					
200 A	None	OH/UG	—	22 kA	QC816F200S OBS [7] [11] [12]	1	QOM2200VH [9]	200 A	8	16	8	200 A [6]	A	6-350	8-2/0	200	43, 21					
	Horn	OH/UG	—	22 kA	QC816F200SH OBS [7] [11] [12]	1	QOM2200VH [9]	200 A	8	16	8	200 A [6]	A	6-350	—	—	—					
	Horn	OH/UG	—	22 kA	QC816F200CH OBS [7] [11]	1	QOM2200VH [9]	200 A	8	16	8	200 A [6]	A	6-350	12-2/0	200	40, 21					
	Lever	OH/UG	—	22 kA	QC816F200SL [7] [11] [12]	1	QOM2200VH [9]	200 A	8	16	8	200 A	A	6-350	8-2/0	200	74 / 12					
Ringless, Homeline™																						
Surface Mount Only																						
125 A	None	OH/UG	—	10 kA	RC8L125S OBS [14]	4	HOM	125 A [15]	—	—	—	—	A	6-2/0	6-2/0	125	27, 32					

[1] To order branch circuit breakers, see QO Plug-On Circuit Breakers, page 1-3
 [2] To order hubs, see Accessories and Hubs for CSEDs, page 1-47
 [3] To order service disconnects, see Circuit Breakers for CSEDs, page 1-46 except as noted)
 [4] Use only 15–110 A and 150–200 A breakers.
 [5] Suitable for OH service with addition of tunnel kit (SCTK20). Order separately.
 [6] Use only 15–100 A and 150–200 A circuit breakers.
 [7] Supplied with load side feed-thru lugs, for 4 AWG–250 kcmil (Al/Cu) conductors.
 [8] Convertible to semiflush with SC200F flange kit (order separately).
 [9] Service disconnect supplied factory-installed.
 [10] A 100 A circuit breaker can be installed in bottom position only, all other positions are limited to 70 A max.
 [11] Device supplied with barrel lock provisions factory-installed.
 [12] 5th jaw factory-installed.
 [13] Use only 15–100 A and 150 A circuit breakers.
 [14] Knockout provided in cover for use with barrel lock kit SCBRLLLOCK (see Accessories).
 [15] 125 A Homeline™ 2P circuit breaker can be installed in top position only. All other positions are limited to 100 A max.

Table 1.81 Rainproof Meter Mains (cont'd.)

Ampere Rating	Bypass Type	Service (Type of Feed)		Short Circuit Current Rating	Cat. No.	Service Disconnect(s)			Load Center and Branch Circuit Breakers (Order separately [16])				Hub Type (Order separately [17])	Line Side Main Lugs AWG/ kcmil (Al/Cu)	Service Ground Lug AWG/ kcmil (Al/Cu)	Bus Rating	Weight Each (Lbs) and Pallet Qty.
		UL	UL and EU-SERC			2P Circuits (Max.)	Type (Order separately [18])	Ampere Rating Max.	Max. Quantity		Ampere Rating Max.						
									Spaces	1P Circuits		Tandems					
200 A	None	OH/UG	—	10 kA	RC12L200S OBS	6	HOM	200 A [19]	—	—	—	—	A	6-350	8-2/0	—	43, 21
200 A	None	OH/UG	—	22 kA	RC12L200C [20]	6	HOM	200 A [19]	—	—	—	—	A	6-350	12-2/0	200	40, 21
Surface Mount Only, Supplied with Feed-Thru Lugs and provisions for Branch Circuit Breakers																	
100 A	Horn	OH/UG	—	22 kA	RC816F100SH OBS [21] [20] [22]	1	QOM2100VH [23]	100 A	8	16	8	100 A	A	6-350	8-2/0	—	43, 21
100 A	Horn	OH/UG	—	22 kA	RC816F125SH OBS [21] [20] [22]	1	QOM2100VH [23]	100 A	8	16	8	100 A			12-2/0	—	40, 21
125 A	Horn	OH/UG	—	22 kA	RC816F125SH OBS [21] [20] [22]	1	QOM2125VH [23]	125 A	8	16	8	100 A			8-2/0	—	43, 21
125 A	Horn	OH/UG	—	22 kA	RC816F125CH [21] [20] [22]	1	QOM2125VH [23]	125 A	8	16	8	100 A			12-2/0	200	40, 21
150 A	None	OH/UG	—	22 kA	RC816F150S OBS [21] [20]	1	QOM2150VH [23]	150 A	8	16	8	150 A [24]			8-2/0	—	43, 21
	None	OH/UG	—	22 kA	RC816F150C [21] [20]	1	QOM2150VH [23]	150 A	8	16	8	150 A [24]			12-2/0	200	40, 21
	Horn	OH/UG	—	22 kA	RC816F150SH OBS [21] [20] [22]	1	QOM2150VH [23]	150 A	8	16	8	150 A [24]			8-2/0	—	43, 21
	Horn	OH/UG	—	22 kA	RC816F150CH [21] [20] [22]	1	QOM2150VH [23]	150 A	8	16	8	150 A [24]			12-2/0	200	40, 21
200 A	Lever	OH/UG	—	22 kA	RC816F150SL OBS [20] [22] [25]	1	QOM2150VH [23]	200 A	8	16	8	150 A			8-2/0	200	72 / 12
	None	OH/UG	—	22 kA	RC816F200S OBS [21] [20] [22]	1	QOM2200VH [23]	200 A	8	16	8	200 A [19]			8-2/0	200	43, 21
	None	OH/UG	—	22 kA	RC816F200C [21] [20]	1	QOM2200VH [23]	200 A	8	16	8	200 A [19]			12-2/0	200 [26]	40, 21
	Horn	OH/UG	—	22 kA	RC816F200SH OBS [21] [20] [22]	1	QOM2200VH [23]	200 A	8	16	8	200 A [19]			8-2/0	—	43, 21
	Horn	OH/UG	—	22 kA	RC816F200CH [21] [20] [22]	1	QOM2200VH [23]	200 A	8	16	8	200 A [19]			12-2/0	200	40, 21
200 A	Lever	OH/UG	—	22 kA	RC816F200SL OBS [21] [20] [22] [25]	1	QOM2200VH [23]	200 A	8	16	8	200 A			8-2/0	200	72 / 12
	Horn	OH/UG	—	10 kA	RC816D200CH [27] [21] [22] [28]	1	HOM2200 [23]	200 A	8	16	8	100 A [29]			6-300	6-1/0	200
								50 A									

OBS This product is obsolete.

[16] To order branch circuit breakers, see [QO Plug-On Circuit Breakers](#), page 1-3
 [17] To order hubs, see [Accessories and Hubs for CSEDs](#), page 1-47
 [18] To order service disconnects, see [Circuit Breakers for CSEDs](#), page 1-46 except as noted
 [19] Use only 15-100 A and 150-200 A circuit breakers.
 [20] Device supplied with barrel lock provisions factory-installed.
 [21] Supplied with load side feed-thru lugs, for 4 AWG-250 kcmil (Al/Cu) conductors.
 [22] 5th jaw factory-installed.
 [23] Service disconnect supplied factory-installed.
 [24] Use only 15-100 A and 150 A circuit breakers.
 [25] Suitable for load wires to exit top endwall with addition of Tunnel Kit OHBL, see [Table 1.89 Accessories](#), page 1-47, check with local utility for approval.
 [26] Not solar ready.
 [27] Convertible to semiflush with SC200F flange kit (order separately).
 [28] Knockout provided in cover for use with barrel lock kit SCBRLLOCK (see Accessories).
 [29] A 100 A circuit breaker can be installed in bottom position only, all other positions are limited to 70 A max.

Meter Mains and All-In-Ones (100 to 225 A Maximum)

- Ring or ringless type meter socket designs available
- UL Listed, suitable only for use as service equipment
- Meets EUSERC standards
- Service disconnect(s) are supplied factory-installed, except where noted
- Semiflush-reverse design available, supplied with load center (indoor access)
- Supplied with 100% branch neutrals, all unused terminals may be used for equipment grounding wires.
- Meets Federal Specification W-P-115c as Type 1, Class 2

Table 1.82: All-In-One Combination Service Entrance Devices

Ampere Rating	Bypass Type	Service (Type of Feed) UL and EUSERC	Short Circuit Current Rating	Cat. No. (DE3A)	Service Disconnect(s)			Load Center and Branch Circuit Breakers (Order separately [30])				Hub Type [37] (Order separately)	Line Side Main Lugs AWG/kcmil (Al/Cu)	Service Grounded Lug AWG/kcmil (Al/Cu)	Bus Rating	Weight Each (Lbs) and Pallet Qty.				
					2P Circuits (Max.)	Type (Factory Installed)	Ampere Rating Max.	Max. Quantity		Ampere Rating Max.										
								Spaces	1P Circuits		Tan-dems									
Ring Type, Homeline™																				
Surface Mount Only																				
100 A	None	OH/UG	10 kA	SC1624M100S	1	HOM2100	100 A	16	24	8	100 A	A	6-2/0	6-2/0	125	32, 24				
125 A	None	OH/UG	10 kA	SC1624M125S	1	HOM2125	125 A	16	24	8	125 A [32]	A	6-2/0	6-2/0	125	32, 24				
200 A	None	OH/UG	10 kA	SC2040M200C [33]	1	HOM2200	200 A	20	40	20	100 A	A or A-L	6-300	8-1/0	200	47, 18				
200 A	None	UG	10 kA	SU2040M200C OBS	1	HOM2200	200 A	20	40	20	100 A	A or A-L	6-300	8-1/0	—	47, 18				
Semiflush Mount Only																				
100 A	None	OH/UG	10 kA	SC1624M100F	1	HOM2100	100 A	16	24	8	100 A	A or B300	6-2/0	6-2/0	125	44, 20				
125 A	None	OH/UG	10 kA	SC1624M125F	1	HOM2125	125 A	16	24	8	110 A	A or B300	6-2/0	6-2/0	125	44, 20				
Surface Mount Only																				
100 A	None	OH[34]	10 kA	SO1020M100S	1	HOM2100	100 A	10	20	10	80 A	A	6-1	8-4	100	20, 42				
200 A	None	OH[34]	22 kA	SO2040M200S	1	QOM2200VH	200 A	20	40	20	200 A	A	6-350	8-2/0	200	43, 21				
REVERSE All-In-One—Semiflush Mount with Service Disconnect (outdoor access) and Load Center (indoor access)																				
200 A	None	UG	10 kA	SU3040M200R OBS	1	QOM2200VH	200 A	30	40	10	200 A [35]	A or B300	6-300	12-1/0	—	60, 15				
225 A	None	UG	10 kA	SU3040M225R OBS	1	QOM2225VH	225 A	30	40	10	200 A [35]	A or B300	6-300	12-1/0	—	60, 15				
Ringless, Homeline																				
Surface Mount Only																				
100 A	None	OH/UG [34]	10 kA	RC1624M100S	1	HOM2100	100 A	16	24	8	100 A	A	6-2/0	6-2/0	125	32, 24				
125 A	None	OH/UG [34]	10 kA	RC1624M125S OBS	1	HOM2125	125 A	16	24	8	125 A [32]				—					
125 A	Horn	OH/UG [34]	22 kA	RC2040M125CH OBS [36][37]	1	QOM2125VH	125 A	20	40	20	125 A				200		40, 21			
150 A	Horn	OH/UG [34]	22 kA	RC2040M150SH [36]	1	QOM2150VH	150 A	20	40	20	150 A				—		43, 21			
	Horn	OH/UG [34]	22 kA	RC2040M150CH [36][37]	1	QOM2150VH	150 A	20	40	20	150 A				200		40, 21			
200 A	Lever	OH/UG [34]	22 kA	RC3040M150SL [38]	1	QOM2150VH [32]	200 A	30	40	10	150 A				200		76 / 12			
	None	OH/UG [34]	22 kA	RC2040M200S [36]	1	QOM2200VH	200 A	20	40	20	200 A				200		43, 21			
	None	OH/UG [34]	22 kA	RC2040M200C [36]	1	QOM2200VH	200 A	20	40	20	200 A				200		40, 21			
	Horn	OH/UG [34]	22 kA	RC2040M200SH OBS	1	QOM2200VH	200 A	20	40	20	200 A				—		43, 21			
	Horn	OH/UG [34]	22 kA	RC2040M200CH [36]	1	QOM2200VH	200 A	20	40	20	200 A				200		40, 21			
	Lever	OH/UG [34]	22 kA	RC3040M200SL [38]	1	QOM2200VH [32]	200 A	30	40	10	200 A				200		76 / 12			
None	OH/UG [34]	22 kA	RC2040M200CGP	1	QOM2200VH	200 A	20	40	20	200 A	200				48 / 21					
Ringless, QO																				
Surface Mount Only																				
150 A	Horn	OH/UG [34]	22 kA	QC2442M150SH OBS	1	QOM2150VH	150 A	24	42	18	150 A	A	6-350	8-2/0	—	43, 21				
200 A	None	OH/UG [34]	22 kA	QC2442M200S OBS	1	QOM2200VH	200 A	24	42	18	200 A				—	43, 21				
	None	OH/UG [34]	22 kA	QC2442M200C [36]	1	QOM2200VH	200 A	24	42	18	200 A				200	40, 21				
	Horn	OH/UG [34]	22 kA	QC2442M200SH [36]	1	QOM2200VH	200 A	24	42	18	200 A				—	43, 21				
	Horn	OH/UG [34]	22 kA	QC2442M200CH OBS [36][37]	1	QOM2200VH	200 A	24	42	18	200 A				—	40, 21				
	None	OH/UG [34]	22 kA	QC3040M200S	1	QOM2200VH	200 A	30	40	10	200 A				200	40, 21				
200 A	Horn	OH/UG [34]	22 kA	QC3040M200SH OBS	1	QOM2200VH	200 A	30	40	10	200 A				—	40, 21				

OBS This product is obsolete.

[30] To order branch circuit breakers, see QO Plug-On Circuit Breakers, page 1-3
 [31] To order hubs, see Accessories and Hubs for CSEDs, page 1-47
 [32] 125 A Homeline™ 2P circuit breaker can be installed in top position only. All other positions are limited to 100 A max.
 [33] Convertible to semiflush with SC200F flange kit (order separately).
 [34] Device does not meet EUSERC Specifications.
 [35] Use only 15-110 A and 150-200 A circuit breakers.
 [36] Device supplied with barrel lock provisions factory-installed.
 [37] 5th jaw factory-installed.
 [38] Suitable for load wires to exit top endwall with addition of Tunnel Kit OHBL, (see Table 1.89 Accessories, page 1-47, check with local utility for approval).

New! Energy Center



QOWC60M200PFY Energy Center



Energy Center with Cover Removed

LOAD CENTERS
1

Ampere Rating	Bypass Type	Service (Type of Feed)		Short Circuit Current Rating	Cat. No.	Service Disconnect(s)			Load Center and Branch Circuit Breakers (Order separately [39])			Hub Type [40] (Order separately)	Line Side Main Lugs AWG/kcmil (Al/Cu)	Service Ground Lug AWG/kcmil (Al/Cu)	Bus Ratings	
		UL	UL and EU-SERC			2P Circuits (Max.)	Type (Order separately [41])	Ampere Rating (Max.)	Max. Quantity							Ampere Rating Max.
									Spaces	Circuits	Tandems					
Square D™ Energy Center																
Semi-flush Mount Only																
200 A	—	UG	—	22 kA	QOWC60M200PFY	—	QOM2 [42]	200 A	60 [43]	61	10	200 A	A300L	6–250	14–2/0	225 A

New! Schneider Pulse CSED



Schneider Pulse smart panel intelligently interconnects a home's various energy sources, optimizes energy usage, extends battery run time, and helps minimize the need for a service level upgrade.

- QO™ product range
- Ringed meter socket, no bypass, meets EUSERC
- Specifications
- Service feed: Overhead / Underground (OH / UG)
- Ampere rating: 200 A Maximum
- Busbar rating: 225 A
- Short-circuit current: 22 KA
- Semiflush mounting (surface mounting to be announced)
- Plug-on neutral connections
- Total spaces: 44 (4 used by submains, 2 used by SPD, 2 used by monitor)
- Usable spaces: 36 (18 top interior, 18 bottom interior)
- Battery charging sources: solar, grid
- Submain rating: 125 A (both top and bottom interiors)
- Max solar back-feed: 145 A
- Factory installed power distribution block
- Backup controller (Microgrid Interconnect Device) available as factory or field installed
- Dimensions (W x H x D): 14.3 x 51.9 x 9.7 in.

Table 1.83: Schneider Pulse CSED

Description	Catalog Number
Schneider Pulse CSED	CC18X18M200PCY
Schneider Pulse CSED with backup controller	CC18X18M200PCZ
Circuit breaker hold down kit (optional)	QOCRBGK2EC

[39] To order branch circuit breakers, see [QO Plug-On Circuit Breakers](#), page 1-3
 [40] To order hubs, see [Accessories and Hubs for CSEDs](#), page 1-47
 [41] To order service disconnects, see [Circuit Breakers for CSEDs](#), page 1-46 except as noted)
 [42] One service disconnect with 2 — 110 A sub-main feeds.
 [43] Nine spaces are used for factory-installed components, leaving 51 available spaces for branch circuits.

Meter Mains and All-in-Ones (300–400 A Devices)

Meter Mains and All-in-Ones

- Ring or ringless type meter socket designs available
- UL Listed, suitable **only** for use as service equipment
- Meets EUSERC standards where indicated.

- Service disconnects are supplied factory-installed, except where noted
- Supplied with 100% branch neutrals; all unused terminals may be used for equipment grounding wires
- Meets Federal Specification W-P-115c as Type 1, Class 2

Meter Mains: Meets Federal Specification W-P-115c as Type 1, Class 2, UL Listed, suitable only for use as service equipment, 120/240 Vac, 1Ø3W, NEMA 3R Enclosure

Table 1.84: Meter Mains

Ampere Rating	Bypass Type	Service (Type of Feed)		Short-Circuit Current Rating	Cat. No.	Service Disconnect(s) [44]			Load Center and Branch Circuit Breakers (Order separately [45])				Hub Type (Order separately [46])	Line Side Main Lugs AWG/kcmil (Al/Cu)	Bus Rating	Service Ground Lug AWG/kcmil (Al/Cu)	Weight Each (Lbs) and Pallet Qty.
		UL	UL and EU-SERC			2P Circuits (Max.)	Type (Order separately [47])	Ampere Rating (Max.)	Max. Quantity		Ampere Rating Max.						
									Spaces	Circuits		Tandems					
Ring Type, QO																	
Surface and Semiflush Mount [44]																	
400 A	None	UG	UG	25 kA	CU12L400CN [48]	1	QDL22200 [49]	200 A	—	—	—	—	A-L	(2) Studs	200	4–250	98, 4
400 A	Class 320 Manual Bypass	UG	—	25 kA	CU12L400CB [48] [50]	1	QDL22200 [49]	200 A	—	—	—	—	A-L	(2) Studs	200	4–250	98, 4
					CU12L400FB OBS	4	QDL, QGL, QJL [51]	200 A	—	—	—	—			—		
400 A	Class 320 Manual Bypass	UG	—	25 kA	CU816D400CN [48] [54]	1	QDL22200 [49]	200 A	8	16	8	200 A	A-L	(2) Studs	200	4–250	98, 4
					CU816D400CB [48] [53] [50]		QDL, QGL, QJL [51]										
400 A	Class 320 Manual Bypass	UG	—	65 kA [44]	CUM400CB [48] [50]	1	LJL36400U31X [49]	400 A	—	2 [55]	—	200 A	A-L	(2) Studs	—	4–250	115, 4
Ringless Type, QO																	
400 A	Class 320 Lever	UG	—	25 kA	QU12L400SL [56] [50]	1	QDL22200 [49]	200 A	—	—	—	—	A-L	(2) Studs	200	4–250	98, 4
						1	QDL, QGL, QJL [51]	200 A	—	—	—						
						4	QO, QO-VH or QOH [52]	125 A [53]	—	—	—						
400 A	Class 320 Lever	OH/UG	—	25 kA	QCD400SL [56]	1	QDL, QGL, QJL [51]	200 A	—	—	—	A-L	(2) Studs	4–600 (2) 1/0–350	—	12–2/0	75, 4
						1	QDL, QGL, QJL [51]	200 A	—	—	—						
Surface Mount Only, Supplied with Feed-Thru Lugs and Provisions for Branch Circuit Breakers																	
400 A	[57]	UG	—	25 kA	QU816D400SL [53] [56] [50]	1	QDL22200 [49]	200 A	8	16	8	200 A	A-L	(2) Studs	200	4–250	98, 4
				QU816D400CK OBS [54] [50]	QDL, QGL, QJL [51]		200 A										
400 A	Class 320 Lever	OH/UG	—	25 kA	QC816D400SL [53] [54] [56]	1	QDL22200 [49]	200 A	8	16	8	200 A	A-L	(2) Studs	200	12–2/0	77, 4
						1	QDL, QGL, QJL [51]	200 A									
Surface and Semiflush Mount [44]																	
400 A	Class 320 Lever	UG	—	25 kA	QU12L400CL OBS [56] [58] [50]	1	QDL22200 [49]	200 A	—	—	—	—	A-L	(2) Studs	200	4–250	98, 4
						1	QDL, QGL, QJL [51]	200 A	—	—	—						
						4	QO, QO-VH or QOH [52]	125 A [53]	—	—	—						
400 A	Class 320 Lever	UG	—	25 kA	QU816D400CL [56] [53] [58] [50]	1	QDL22200 [49]	200 A	8	16	8	200 A	A-L	(2) Studs	200	4–250	98, 4
					QU816D400FL OBS	1	QDL, QGL, QJL [51]								—		
400 A	Class 320 Lever	UG	—	65 kA [44]	QUM400CL [56] [50]	1	LJL36400U31X [49]	400 A	—	2 [55]	—	200 A	A-L	(2) Studs	—	4–250	120, 4
400 A	K-4 Bolt-On None	UG	—	65kA [44]	QUM400CK OBS	1	LJL36400U31X [49]	400 A	—	2 [55]	—	200 A	A-L	(2) Studs	—	4–250	123, 4
Ringless Type, Homeline																	
Surface Mount Only, Supplied with Feed-Thru Lugs and Provisions for Branch Circuit Breakers																	

[44] UL short circuit current rating is equal to the lowest interrupting rating of any circuit breaker installed.
 [45] To order branch circuit breakers, see QO Plug-On Circuit Breakers, page 1-3
 [46] To order hubs, see Accessories and Hubs for CSEDs, page 1-47
 [47] To order service disconnects, see Circuit Breakers for CSEDs, page 1-46 except as noted)
 [48] For use only on 120/240 Vac 1Ø3W system (4-jaw meter socket).
 [49] Service disconnect supplied factory-installed.
 [50] Device configuration is not included in EUSERC standards. Consult applicable utility for acceptance.
 [51] Additional service disconnect for field-installation: order prefix QBL at 10 kA, QDL at 25 kA, QGL at 65 kA, or QJL at 100 kA. Order separately. For complete circuit breaker catalog number, see Digest Section 7.
 [52] Order two pole circuit breakers for field installation: order catalog designation QO for 10 kA, QO-VH for 22 kA or QOH for 42 kA short circuit current rating. See Table 1.1 Plug-On Circuit Breakers, page 1-3 or Table 1.88 Circuit Breakers for use with Meter Mains and All-In-One Devices, page 1-46.
 [53] QO panel is rated 200 A maximum.
 [54] Supplied with load side feed-thru lugs for 6 AWG–250 kcmil (Al/Cu) conductors.
 [55] Option for field installation of two Q-frame, 200 A max. 2-pole branch circuit breakers used as mains for two downstream load centers. Purchase installation kit BMK2Q400 and two Q-frame circuit breakers separately. Order QBL prefix at 10 kA, QDL prefix at 25 kA, or QGL prefix at 65 kA.
 [56] Fifth jaw factory-installed.
 [57] Device with suffix L has Class 320 lever bypass and device with suffix K has a K-4 bolt-on, no bypass.
 [58] Knockout provided in cover for use with barrel lock kit SCBRLOCK (see Table 1.89 Accessories, page 1-47).

Table 1.84 Meter Mains (cont'd.)

Ampere Rating	Bypass Type	Service (Type of Feed)		Short-Circuit Current Rating	Cat. No.	Service Disconnect(s) [59]			Load Center and Branch Circuit Breakers (Order separately [60])				Hub Type (Order separately [61])	Line Side Main Lugs AWG/kcmil (Al/Cu)	Bus Rating	Service Ground Lug AWG/kcmil (Al/Cu)	Weight Each (Lbs) and Pallet Qty.
		UL	UL and EU-SERC			2P Circuits (Max.)	Type (Order separately [62])	Ampere Rating (Max.)	Max. Quantity		Ampere Rating Max.						
									Spaces	Circuits		Tandems					
400 A	Class 320 Lever	OH/UG	—	25 kA	RC816D400SL [63] [64]	1	QDL22200 [65]	200 A	8	16	8	200 A	A-L	4-600 (2) 1/0-350	200	12-2/0	77, 4
						1	QDL, QGL, QJL [66]										

OBS This product is obsolete.

Table 1.85: All-in-One Combination Service Entrance Devices

Surface and Semiflush Mount[59]																	
Ring Type, Homeline																	
300 A	Class 320 Manual	UG	—	25 kA	SU3040D300CB [67][68][69]	1	QDL22200 [70] QDL, QGL, QJL [71]	200 A 100 A	30	40	10	200 A	A-L	(2) Studs	200	4-250	100, 4
					SU3040D300FB [67] [68][69]	1											
400 A	None	UG	UG	25 kA	SU3040D400CN [67] [68]	1	QDL22200 [70] QDL, QGL, QJL [71]	200 A 200 A	30	40	10	200 A	A-L	(2) Studs	200	4-250	100, 4
					SU3040D400FN [67] [68]	1									200		
400 A	Class 320 Manual	UG	—	25 kA	SU3040D400CB [67] [68][69]	1	QDL22200 [70]	200 A	30	40	10	200 A	A-L	(2) Studs	200	4-250	100, 4
					SU3040D400FB [67] [68][69]	1	QDL, QGL, QJL [71]								200 A		
Ringless, Homeline																	
400 A	Class 320 Lever	UG	—	25 kA	RU3040D400CL [68] [72][69]	1	QDL22200 [70]	200 A	30	40	10	200 A	A-L	(2) Studs	200	4-250	100, 4
					RU3040D400FL [68] [72][69]	1	QDL, QGL, QJL [71]								200 A		
400 A	K-4 Bolt-on	UG	—	25 kA	RU3040D400CK [68][69]	1	QDL22200 [70] QDL, QGL, QJL [71]	200 A 200 A	30	40	10	200 A	A-L	(2) Studs	—	4-250	100, 4
					RU3040D400FK [68][69]	1	—								—		

OBS This product is obsolete.

[59] UL short circuit current rating is equal to the lowest interrupting rating of any circuit breaker installed.

[60] To order branch circuit breakers, see QO Plug-On Circuit Breakers, page 1-3

[61] To order hubs, see Accessories and Hubs for CSEDs, page 1-47

[62] To order service disconnects, see Circuit Breakers for CSEDs, page 1-46 except as noted

[63] Supplied with load side feed-thru lugs for 6 AWG–250 kcmil (Al/Cu) conductors.

[64] Fifth jaw factory-installed.

[65] Service disconnect supplied factory-installed.

[66] Additional service disconnect for field-installation: order prefix QBL at 10 kA, QDL at 25 kA, QGL at 65 kA, or QJL at 100 kA. Order separately. For complete circuit breaker catalog number, see Digest Section 7.

[67] For use only on 120/240 Vac 1Ø3W system (4-jaw meter socket).

[68] Knockout provided in cover for use with barrel lock kit SCBRLLLOCK (see Accessories).

[69] Device configuration is not included in EUSERC standards. Consult applicable utility for acceptance.

[70] Service disconnect supplied factory-installed.

[71] Additional service disconnect for field-installation: order prefix QBL at 10 kA, QDL at 25 kA, QGL at 65 kA, or QJL at 100 kA. Order separately. For complete circuit breaker catalog number, see Digest Section 7.

[72] 5th jaw factory-installed.

Dimensions for CSEDs

Table 1.86: Knockouts

Symbol	A	B	C	D	E	F	G	H	I	J
Conduit Size (in.)	1/2	3/4	1	1-1/4	1-1/2	2	2-1/2	3	3-1/2	4

- ▲ Drip hood supplied factory-installed and is required for surface mount installation. For semi-flush installation, remove drip hood and install flange kit SC200F (order separately).
- Unit supplied with blank top endwall (factory-installed) for surface mount installation. For semi-flush installation, install flange kit FK400 (order separately). Kit includes replacement top endwall (with knockouts) and flanges.
- ◆ Unit supplied with semi-flush top endwall factory installed and semi-flush flanges factory included.

LOAD CENTERS

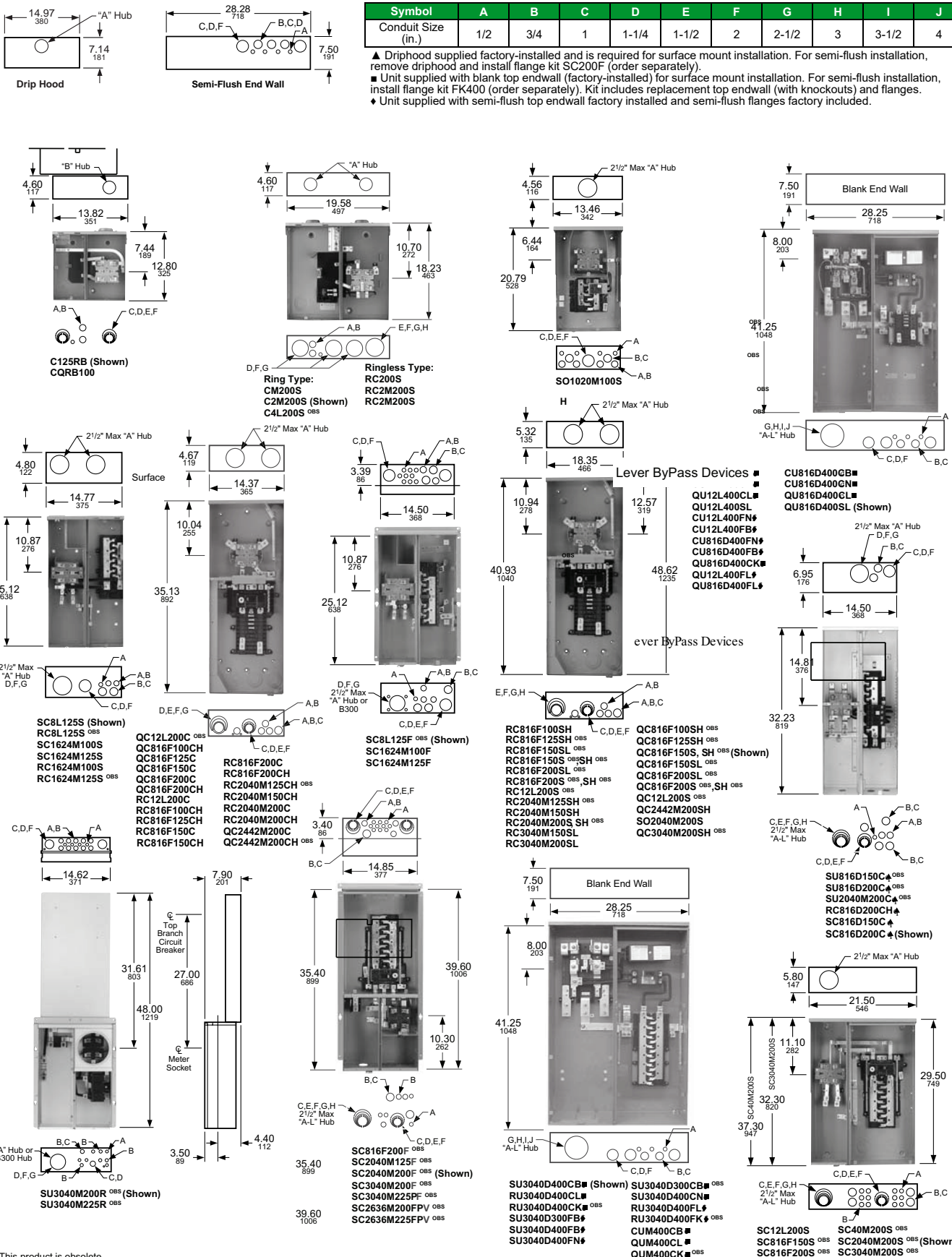

obs This product is obsolete.

Solar Ready PoN CSEDs

- Ring or ringless type meter socket designs available
- UL Listed, suitable only for use as service equipment
- Service disconnect(s) are supplied factory-installed, except where noted
- Interiors accept plug-on neutral and pigtail style branch circuit breakers
- Supplied with a fully distributed neutral bar, all unused terminals may be used for equipment grounding wires
- Meets Federal Specification W-P-115c as Type 1, Class 2
- Solar ready kits for line side tap available, see accessories table
- All devices have a 3" KO in the bottom endwall
- Provisions for field installed CTs on All devices

Amperage Rating	Bus Bar Amperage Rating	Bypass type	Service (Type of Feed)	Short Circuit Current Rating	Cat. No.	Service Disconnect(s)		Load Center and Branch Circuit Breakers (Order separately pages....)				Bus Rating	Hub Type	Line Side Main Lugs	Service Ground Lug
						2P Circuits	Type (Factory installed except where noted)	Spaces	Circuits	Tandems	Ampere Rating Max.				
Ring Type, QO															
Surface Mount Only															
100 A	225 A	None	UG	22 kA	CU816F100PS ^{[1][2]}	1	QOM2100VH	8	16	8	70 A	—	A-L	4-250	14-2/0 CU 12-2/0 AL
200 A		None	UG	22 kA	CU48F200PS ^{[1][2]}	1	QOM2200VH	4	8	4	110 A	—			
200 A		None	UG	22 kA	CU816F200PS ^{[1][2]}	1	QOM2200VH	8	16	8	110 A	—			
Ring Type, Homeline															
Surface Mount Only															
100 A	225 A	None	UG	22 kA	SU816F100PS ^{[1][2]}	1	QOM2100VH	8	16	8	70 A	—	A-L	4-250	14-2/0 CU 12-2/0 AL
200 A		None	UG	22 kA	SU48F200PS ^{[1][2]}	1	QOM2200VH	4	8	4	110 A	—			
200 A		None	UG	22 kA	SU816F200PS ^{[1][2]}	1	QOM2200VH	8	16	8	110 A	—			
150 A		None	OH/UG	22 kA	SC816F150PS ^{[1][2]}	1	QOM2150VH	8	16	8	150 A	225			8-2/0
200 A		None	OH/UG	22 kA	SC816F200PS ^{[1][2]}	1	QOM2200VH	8	16	8	200 A	225			
200 A		None	OH/UG	22 kA	SC2040M200PS ^[2]	1	QOM2200VH	20	40	20	200 A	225			
200 A		None	OH/UG	22 kA	SC3042M200PS ^[2]	1	QOM2200VH	30	42	12	200 A	225			
200 A		None	OH/UG	22 kA	SC42M200PS ^[2]	1	QOM2200VH	42	42	0	200 A	225			
200 A		None	OH/UG	22 kA	SC816F200PF ^{[1][2]}	1	QOM2200VH	8	16	8	200 A	225			
125 A	225 A	None	OH ^[3] /UG	22 kA	SC2040M125PF ^[2]	1	QOM2125VH	20	40	20	110 A	225	A-L	4-250	8-2/0
200 A		None	OH ^[3] /UG	22 kA	SC2040M200PF ^[2]	1	QOM2200VH	20	40	20	200 A	225			
200 A		None	OH ^[4] /UG	22 kA	SC3042M200PF ^[2]	1	QOM2200VH	30	42	12	200 A	225			
225 A		None	OH ^[4] /UG	22 kA	SC3042M225PF ^[2]	1	QOM2225VH	30	42	12	200 A	225			
Ringless, QO															
Surface Mount Only															
100 A	225 A	None	UG	22 kA	QU48F100PS ^[1]	1	QOM2100VH	4	8	4	70 A	—	A-L	4-250	14-2/0 CU 12-2/0 AL
100 A		Lever	UG	22 kA	QU48F100PSL ^[1]	1	QOM2100VH	4	8	4	70 A	—			
125 A		None	UG	22 kA	QU48F125PS ^[1]	1	QOM2125VH	4	8	4	70 A	—			
150 A		None	UG	22 kA	QU48F150PS ^[1]	1	QOM2150VH	4	8	4	110 A	—			
200 A		None	UG	22 kA	QU48F200PS ^[1]	1	QOM2200VH	4	8	4	110 A	—			
150 A		None	UG	22 kA	QU816F150PS ^[1]	1	QOM2150VH	8	16	8	110 A	—			
200 A		None	UG	22 kA	QU816F200PS ^[1]	1	QOM2200VH	8	16	8	110 A	—			
200 A		Lever	UG	22 kA	QU816F200PSL ^[1]	1	QOM2200VH	8	16	8	110 A	—			
200 A		None	UG	22 kA	QU816M200PS	1	QOM2200VH	8	16	8	110 A	—			
200 A		None	UG	22 kA	QU816M200PS	1	QOM2200VH	8	16	8	110 A	—			
Ringless, Homeline															
Surface Mount Only															
100 A	225 A	None	UG	22 kA	RU48F100PS ^[1]	1	QOM2100VH	4	8	4	70 A	—	A-L	4-250	14-2/0 CU 12-2/0 AL
100 A		Lever	UG	22 kA	RU48F100PSL ^[1]	1	QOM2100VH	4	8	4	70 A	—			
125 A		None	UG	22 kA	RU48F125PS ^[1]	1	QOM2125VH	4	8	4	70 A	—			
150 A		None	UG	22 kA	RU48F150PS ^[1]	1	QOM2150VH	4	8	4	110 A	—			
200 A		None	UG	22 kA	RU48F200PS ^[1]	1	QOM2200VH	4	8	4	110 A	—			
150 A		None	UG	22 kA	RU816F150PS ^[1]	1	QOM2150VH	8	16	8	110 A	—			
200 A		None	UG	22 kA	RU816F200PS ^[1]	1	QOM2200VH	8	16	8	110 A	—			
200 A		Horn	UG	22 kA	RU816F200PSH ^[1]	1	QOM2200VH	8	16	8	110 A	—			
200 A		Lever	UG	22 kA	RU816F200PSL ^[1]	1	QOM2200VH	8	16	8	110 A	—			
200 A		None	UG	22 kA	RU816M200PS	1	QOM2200VH	8	16	8	110 A	—			

Table 1.87: Knockouts

Symbol	A	B	C	D	E	F	G	H	I	J
Conduit Size (in.)	1/2	3/4	1	1-1/4	1-1/2	2	2-1/2	3	3-1/2	4

[1] Supplied with load side feed-thru lugs, for 4AWG-250 kcmil Al/Cu conductors.
 [2] Meets EUSERC requirements.
 [3] Suitable for OH service with addition of tunnel kit (SCTKP20). Check with local utility for approval and order separately.
 [4] Suitable for OH service with addition of tunnel kit (SCTKP30). Check with local utility for approval and order separately.

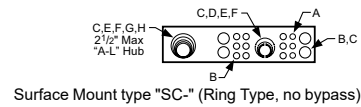
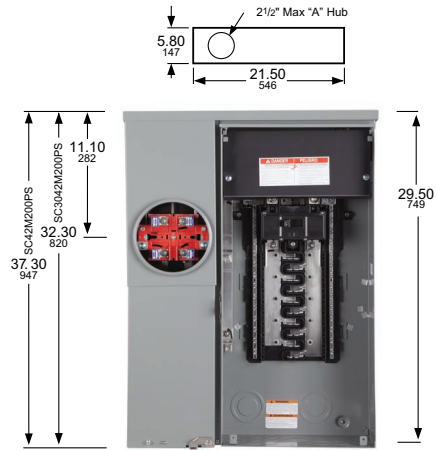
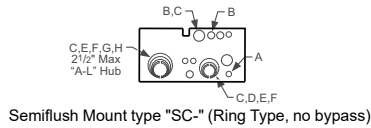
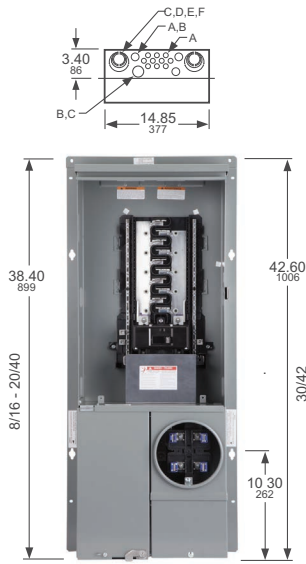

NOTE: See each catalog number's associated technical drawing online for additional dimensions and enclosure details.

Circuit Breakers for CSEDs

Table 1.88: Circuit Breakers for use with Meter Mains and All-In-One Devices

Ampere Rating [1]	Type: HOM, 1P	Type: HOM, 2P	Type: QO, 1P	Type: QO, 2P	Type: QO-VH, 1P	Type: QO-VH, 2P
	Cat. No. (DE3D)	Cat. No. (DE3D)	Cat. No. (DE2A)	Cat. No. (DE2A)	Cat. No. (DE2A)	Cat. No. (DE2A)
10	—	—	QO110	—	—	—
15	HOM115	—	QO115	—	QO115VH	—
20	HOM120	—	QO120	—	QO120VH	—
25	HOM125	—	QO125	—	QO125VH ^{OBS}	—
30	HOM130	HOM230	QO130	QO230	QO130VH	QO230VH
35	—	HOM235	QO135	QO235	—	—
40	HOM140	HOM240	QO140	QO240	—	QO240VH
45	—	HOM245	QO145 ^{OBS}	QO245	—	—
50	HOM150	HOM250	QO150	QO250	—	QO250VH
60	—	HOM260	QO160	QO260	—	QO260VH
70	—	HOM270	QO170	QO270	—	QO270VH
80	—	HOM280	—	QO280	—	QO280VH
90	—	HOM290	—	QO290	—	QO290VH
100	—	HOM2100	—	QO2100	—	QO2100VH
110	—	HOM2110	—	QO2110	—	QO2110VH
125	—	HOM2125	—	QO2125	—	QO2125VH
150	—	HOM2150BB	—	QO2150	—	QO2150VH
175	—	HOM2175BB	—	QO2175	—	QO2175VH ^{OBS}
200	—	HOM2200BB	—	QO2200	—	QO2200VH

^{OBS} This product is obsolete.

Ampere Rating [1]	Type: QOM1-VH, 2P	Type: QOM2-VH, 2P	Type: QDL, 2P [2]
	Cat. No. (DE3D)	Cat. No. (DE3D)	Cat. No. (DE2A)
50	QOM50VH [3]	—	—
60	QOM60VH	—	—
70	QOM70VH	—	QDL22070
80	QOM80VH	—	QDL22080
90	QOM90VH	—	QDL22090
100	QOM100VH	QOM2100VH	QDL22100
110	QOM110VH	—	QDL22110
125	QOM125VH	QOM2125VH	QDL22125
150	—	QOM2150VH	QDL22150
175	—	QOM2175VH	QDL22175
200	—	QOM2200VH	QDL22200
225	—	QOM2225VH	—

[1] Do not exceed mains rating of device

[2] For additional interrupting rating circuit breakers, order circuit breaker prefix QBL at 10 kA, QGL at 65 kA or QJL at 100 kA.

[3] Reference National Electrical Code Article 230-79.

Accessories and Hubs for CSEDs

Table 1.89: Accessories

Description		Cat. No.
Generator Kit: Interlocks main service disconnect and generator circuit breaker (order separately). For : Homeline™ CSED Devices RC816F-, RC2040M-, SO2040M- containing suffix -C or -CH QO CSED Devices QC816F-, QC2442M- containing suffix -C or -CH		RCGK2 QCGK3
Backfed inverter circuit breaker retaining kit for SC2636M225FPV		PK2SCPV ^{OBS}
Fifth Jaw Kit for:	Meter Main Types: C, RC, SC, QC All-In-One Types: SC, SU (100–225 A), QC, RC, SO	5J
Bypass (Horn Type) for Ringless Type Meter Mains and All-In-Ones (100–200 A) (except for RC8L125S, RC1624M100S and RC1624M125S—use RCHB).		MMHB
Lexan Meter Socket Cover Plate for: Ring and Ringless Type Meter Mains Ring and Ringless Type All-In-Ones		29007
Meter Socket Sealing Rings for Ring Type Meter Mains and All-In-Ones: Snap Type Aluminum (Std.) Screw Type Aluminum Snap Type Stainless Steel		2920910001 29008W ARP00026
Anti-Inversion Kit . For use ONLY on 400 A Meter Mains and All-In-Ones with lever bypass.		MMLRK
Trim Kit for 2 in. X 6 in. stud wall, used with Reverse All-In-Ones, SU3040M200R, and SU3040M225R		SU2X6TRIM
Barrel Lock Kit (Barrel Lock not included), supplied with bracket and mounting screw, refer to listings for where used.		SCBRLLOCK ^{OBS}
Semiflush Flange Kit for:	Meter Mains: SC816D150/200C and RC816D200CH All-In-Ones: SC2040M200C	SC200F
Semiflush Flange Kit for ring- and ringless-type Meter Mains and All-In-Ones (400 A Only)		FK400
Lug Kit includes (4) lugs, for use with 2 AWG–600 kcmil Al/Cu conductors. Lugs are for standard 2-Hole mounting. Meter Main and All-In-One units supplied with (2) studs per phase and neutral will accept one lug per phase and neutral. Not for use on 400 A devices with "K" suffix.		C MELK4
Branch Circuit Breaker Field Installation Kit for two Q-Frame Circuit Breakers (QBL, QDL, or QGL, order separately). For CUM400CB, QUM400CL or QUM400CK - includes (2) mounting pans, (4) wires.		BMK2Q400
Overhead Feed Trough for 400 A ring- and ringless-type Meter Mains and All-In-Ones.		O CK400
Touch-Up Paint (ASA49 Gray)		PK49SP
Ground Bar Kit, Meter Mains and All-In-Ones QC, RC, and SC (100–225 A)		PK15GTA
Filler Plate for:	Meter Main Types: QC, CU All-In-One Types: QC	QOFP
Filler Plate for:	Meter Main Types: RC, SC All-In-One Types: SC, RC, SU	HOMFP
Neutral Lug (6-2/0 AWG) for:	Meter Main Types: RC, SC, QC All-In-One Types: SC, SU, QC, RC	LK100AN
Overhead Barrier Tunnel Kit for Ringless & Horn Bypass in RC/QC Devices		OHBS ^{OBS}
Overhead Barrier Tunnel Kit for Lever Bypass RC/QC Devices		OHBL
Solar Ready Kit for Type SC Semiflush Mounted Solar Ready Devices (includes lugs and replacement UL67 barrier)		SR69064AF
Solar Ready Kit for Type SC Surface Mounted Solar Ready Devices (includes lugs and replacement UL67 barrier)		SR69064AS
Energy Center Manual Transfer Kit		QO2DTEC
Energy Center Hold-Down Bracket Kit		QOCRBGK2EC
Solar Ready Kit for UG 200 A Max Meter Mains		SRKUGMM
Generator Kit for RU/SU/QU/CU- 200 A Max Meter Mains		SRUGK

^{OBS} This product is obsolete.

Table 1.90: Hubs and Closing Plates

Hub Series	Conduit Size (inches)	Cat. No.	Disc. Sch.
Closing Plate for "A" Hub opening			
A	1.00	A100	DE4
	1.25	A125	DE4
	1.50	A150	DE4
	2.00	A200	DE4
	2.50	A250	DE4
Adapter plate to allow use of "A" Hubs on "A-L" size hub openings		AAP	DE4
Closing Plate for "A-L" Hub opening			
A-L	2.00	A200L [1]	DE4
	2.50	A250L	DE4
	3.00	A300L	DE4
	3.50	A350L	DE4
	4.00	A400L	DE4
Closing Plate for "B" Hub opening			
B	0.75	B075	DE1A
	1.00	B100	DE1A
	1.25	B125	DE1A
	1.50	B150	DE1A
	2.00	B200	DE1A
	2.50	B250	DE1A
B300	3.00	B300	DE1A

[1] Supplied with AAP adapter plate and "A" hub.

New!

Schneider Energy Monitor

The Schneider Energy Monitor (formerly Wiser Energy) helps manage electricity usage, from the circuit to the plug level with an easy-to-use app. This gives meaningful insight to take control of energy usage and reduce electric bills.

- Monitor what is powered on in the home
- Reduce electric bills with 24/7 real time tracking of home energy usage.
- Easy installation to home electrical panel.
- Circuit-level control using Control Relays for backup power and advanced load management.
- * Integrate the Schneider Inverter, Boost battery, and Connected Devices with the Schneider Home app.

More information can be found at:

<https://www.se.com/us/en/home/offers/connected-home/>

Table 1.91: Schneider Energy Monitor (formerly Wiser Energy)

Description	Contents	CT Rating	Catalog Number
Schneider Energy Monitor (formerly Wiser Energy) is intended for installation in new or existing 120 V split-phase residential panels; cETLus listed			
Schneider Energy Monitor	Monitoring hub, Main CTS	200 A	WISEREMZ
Schneider Energy Monitor Solar version	Monitoring hub, Main CTS, Solar CTS		WISEREMPVZ
* Schneider Energy Monitor Solar version with PoE	Monitoring hub, Main CTS, Solar CTS, PoE		SEMONITOR
Schneider Energy Monitor Solar add-on CT Kit	Solar CTS (hub purchased separately)		WISERCTPV
Schneider Energy Monitor CT extension cable - 4 ft.	Solar CTS (hub purchased separately)	N/A	WISEREMCTEXT4
Schneider Energy Monitor CT extension cable - 12 ft.			WISEREMCTEXT12
Schneider Energy Monitor CT extension cable - 25 ft.			WISEREMCTEXT25
Schneider Energy Monitor CT extension cable - 40 ft.			WISEREMCTEXT40

New!

Schneider Boost and Inverter

Schneider Boost and Inverter provide an easier solution for the increasingly complex needs of solar and battery installations. With fewer steps of power conversion, Boost battery can charge more efficiently from solar for maximum electricity bill savings. When installed with Schneider Pulse, Boost and Inverter provide backup power to protect the home from outages.



Description	Catalog Number
Inverter, 7.7 kW for Residential Solar and Battery	HY8K1NA1
Home Battery, Boost, 10 kWh, LFP	BAT10K1
Backup Controller, Pulse, 120/240 Vac, 200 A, MID, 12 space QO breaker panel	BC200A1NAWM
Battery accessories for 2-stack installation	BA10KNA2S
Battery accessories for 3-stack installation	BA10KNA3S

Visit [Schneider Home Solar and Energy Storage](https://www.se.com/us/en/home/solar-and-energy-storage/) on www.se.com/us.

New!

Square D™ Control Relays

Management and control at the circuit level.

Pair the Schneider Energy Monitor with Square D Control Relays to turn any of our QO™ load panels into a smart, connected panel, providing enhanced home automation and control over individual circuits.

- Smart: Schedule, monitor, and manage energy usage on each circuit
- Flexible: Modular and scalable load control can be added at any time to any circuit
- Easy to Maintain: Easily replace the impacted relay with minimal rewiring.



Table 1.92: Square D Control Relays

Description	Catalog Number	Spaces	Circuits	Voltage	Works With	Cert.	Requires	W x H x D (mm)	W x H x D in.	A (Max)
Square D Control Relay 120 V Dual Relay	QO200PWX120	2	2	120/60 Hz	Wiser Home App*	cULus	WISEREMPVZ WISEREMZ	127 x 36 x 66	5 x 1.4 x 2.6	20
	QO200PWX240									30
Square D Control Relay 240 V	QO260PWX240	4	1	240/60 Hz	Wiser Home App*	cULus	WISEREMPVZ WISEREMZ	127 x 73 x 66	5 x 2.8 x 2.6	60
	QO260PWX240									60

* WISEREMZ and WISEREMPVZ compatible with the Wiser Energy app until Fall 2024.



Dimmers, Switches, and Outlets

Management and control at the device level.

Square D X Series Wiring Devices

X Series connected products include outlets (receptacles).

With Matter compliance and intelligent connectivity, the new X Series connected wiring devices can be controlled through any major smart home platform such as Amazon, Alexa, Google Home, and Apple HomeKit.

This next chapter of X Series wiring devices offers the same stylish design and color selection as our non-connected X Series devices.

View the X Series products at <https://www.se.com/us/en/product-range/26420638> or scan the QR code.



Table 1.93: Square D X Series Wiring Devices

Description	Catalog Number	Gang	Tech	Amp. Rating (A)	Voltage Rating (Vac)	No. of Poles	Device Type	Nominal Load 1 (W)	Load Type 1	Nominal Load 2 (W)	Load Type 2
Switch, X Series, single pole, 3 way, WiFi, Matter, white, matte finish, neutral required	SQR141U1WHWM	1	2.4 GHz Wi-Fi	15	120	1	Multi-way	600	Halogen, Incandescent	-	-
Switch, X Series, single pole, 3 way, WiFi, Matter, black, matte finish, neutral required	SQR141U1BKWM	1	2.4 GHz Wi-Fi	15	120	1	Multi-way	600	Halogen, Incandescent	-	-
Switch, X Series, single pole, 3 way, WiFi, Matter, light almond, matte finish, neutral required	SQR141U1LAWM	1	2.4 GHz Wi-Fi	15	120	1	Multi-way	600	Halogen, Incandescent	-	-
Switch, X Series, single pole, 3 way, WiFi, Matter, grey, matte finish, neutral required	SQR141U1GYWM	1	2.4 GHz Wi-Fi	15	120	1	Multi-way	600	Halogen, Incandescent	-	-
Dimmer, X Series, rocker, 600W, single pole, 3 way, WiFi, Matter, white, matte finish, neutral required	SQR226U1WHWM	1	2.4 GHz Wi-Fi	15	120	1	Multi-way	600	Halogen, Incandescent	150	Dimmable LED
Dimmer, X Series, rocker, 600W, single pole, 3 way, WiFi, Matter, black, matte finish, neutral required	SQR226U1BKWM	1	2.4 GHz Wi-Fi	15	120	1	Multi-way	600	Halogen, Incandescent	150	Dimmable LED
Dimmer, X Series, rocker, 600W, single pole, 3 way, WiFi, Matter, light almond, matte finish, neutral required	SQR226U1LAWM	1	2.4 GHz Wi-Fi	15	120	1	Multi-way	600	Halogen, Incandescent	150	Dimmable LED
Dimmer, X Series, rocker, 600W, single pole, 3 way, WiFi, Matter, Grey, matte finish, neutral required	SQR226U1GYWM	1	2.4 GHz Wi-Fi	15	120	1	Multi-way	600	Halogen, Incandescent	150	Dimmable LED
Socket-outlet, X Series, 15A, decorator, tamper resistant, WiFi, Matter, white, matte finish, neutral required	SQR441U1WHWM	1	2.4 GHz Wi-Fi	15	125	2	Duplex	-	-	-	-
Socket-outlet, X Series, 15A, decorator, tamper resistant, WiFi, Matter, black, matte finish, neutral required	SQR441U1BKWM	1	2.4 GHz Wi-Fi	15	125	2	Duplex	-	-	-	-
Socket-outlet, X Series, 15A, decorator, tamper resistant, WiFi, Matter, light almond, matte finish, neutral required	SQR441U1LAWM	1	2.4 GHz Wi-Fi	15	125	2	Duplex	-	-	-	-
Socket-outlet, X Series, 15A, decorator, tamper resistant, WiFi, Matter, Grey, matte finish, neutral required	SQR441U1GYWM	1	2.4 GHz Wi-Fi	15	125	2	Duplex	-	-	-	-
Dimmer, X Series, rocker, 600W, single pole, 3 way, WiFi, Matter, white, matte finish, wall plate, neutral required	SQR226U1WHWMP	1	2.4 GHz Wi-Fi	15	125	1	Multi-way	600	Halogen, Incandescent	150	Dimmable LED
Socket-outlet, X Series, 15A, decorator, tamper resistant, WiFi, Matter, white, matte finish, wall plate, neutral required	SQR441U1WHWMP	1	2.4 GHz Wi-Fi	15	125	2	Duplex	-	-	-	-
Switch, X Series, single pole, 3 way, WiFi, Matter, white, matte finish, wall plate, neutral required	SQR141U1WHWMP	1	2.4 GHz Wi-Fi	15	120	1	Multi-way	600	Halogen, Incandescent	-	-

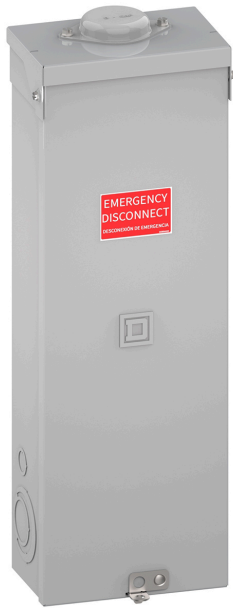

Enclosure



PowerPact Q-Frame
Molded Case Circuit Breaker

Service Entrance Devices

Table 1.94: Residential Enclosed Circuit Breakers with PowerPact Q Frame MCBs

Enclosure	Mains Rating	Short Circuit Rating	Commercial Reference	Included in Package
Rainproof NEMA 3R	150 A	25 kA	Q2150MRBE	Factory Installed: (1) QDL22150, (1) service entrance barrier, (1) emergency disconnect label & (1) service disconnect label
Rainproof NEMA 3R	200 A	25 kA	Q2200MRBE	Factory Installed: (1) QDL22200, (1) service entrance barrier, (1) emergency disconnect label & (1) service disconnect label
Rainproof NEMA 3R	70-200 A	10-100 kA	Q2200RBE [1]	Factory Installed: (1) emergency disconnect label & (1) service disconnect label Factory Included: (1) service entrance barrier[2]

Table 1.95: Replacement Kit for Residential Enclosed Circuit Breakers with PowerPact Q Frame

Mains Rating	Short Circuit Rating	Commercial Reference	Included in Package
70 -200 A	10-100 kA	PKSB1Q2	(1) Service entrance barrier & (1) emergency disconnect label.[3]

Table 1.96: PowerPact Q-Frame Molded Case Circuit Breakers for Residential Enclosed Circuit Breakers

Service	Type 3R — Rainproof Circuit Breaker not included	Ampere rating	Short Circuit Rating			
			10 k AIR	25 k AIR	65 k AIR	100 k AIR
2P 240 Vac Maximum	Q2200RBE	70 A	QBL22070	QDL22070	QGL22070	QJL22070
		80 A	QBL22080	QDL22080	QGL22080	QJL22080
		90 A	QBL22090	QDL22090	QGL22090	QJL22090
		100 A	QBL22100	QDL22100	QGL22100	QJL22100
		110 A	QBL22110	QDL22110	QGL22110	QJL22110
		125 A	QBL22125	QDL22125	QGL22125	QJL22125
		150 A	QBL22150	QDL22150	QGL22150	QJL22150
		175 A	QBL22175	QDL22175	QGL22175	QJL22175
		200 A	QBL22200	QDL22200	QGL22200	QJL22200

[1] Suitable ONLY for breakers from 70A-200A. Not compatible with 225A breakers.

[2] Suitable only for 2P Q Frame MCBs only.

[3] Suitable ONLY for breakers from 70A-200A. Not compatible with 225A breakers

Non-Service Entrance Enclosed Devices
1Ø3W—120/240 Vac—240 Vac—UL Listed

Table 1.97: Enclosed Molded Case Switch, Switch Included, Does NOT provide overcurrent protection

Service	Ampere Rating	General Purpose	Rainproof	Box No. [4]
240 Vac	60 A[5][6]	QO260NATS	QO200TR	2, 9R[7]
			QO200TRNM	1NM
			QO260NATR	1R
120/240 Vac	100 A[8]	QO2000NS	QO2000NRB	13, 10R



QO200TRNM



QO3100BNF
With Cover Removed

Table 1.98: Enclosed GFCI Circuit Breakers, GFCI Circuit Breaker Included—10 kA Short Circuit Current Rating

Service	Ampere Rating	Type 3R—Rainproof Circuit Breaker Included	Circuit Breaker Only	Box No. [4]
120/240 Vac	50 A	QOE250GFINM	QO250GFI	1NM (Non-metallic) 1R (Metallic)
		HOME250SPA	HOM250GFI	
		QOE260GFINM	QO260GFI3W	
	60 A			

Table 1.99: 2-Pole Circuit Breaker Enclosures—22 kA Short Circuit Current Rating

Service [9]	Ampere Rating	General Purpose [10]	Rainproof	Box No. [4]
120/240 Vac	100 A 125 A	QO2100BNF/S QO2125BNF ^{OBS} QO2125BNS	QO2100BNRB	13, 10R
			QO2125BNRB	18, 13R
240 Vac	100 A	QO3100BNF/S	QO3100BNRB	13, 10R
60A Max. Circuit Breaker Enclosures—10 kA Short Circuit Current Rating Circuit breaker not included. Order separately from QO Plug-On Circuit Breakers, page 1-3. Will not accept QO-GFI circuit breaker nor QO circuit breakers with factory-installed accessories.				
240 Vac	60 A[5]	—	QO2TR	9R[7]

^{OBS} This product is obsolete.

Table 1.100: Q Frame Enclosures and Q Frame Circuit Breakers

Service	Enclosure Only [11]			Circuit Breaker (Order Separately)				
	Type 1—General Purpose [10]	Type 3R—Rainproof	Box No. [4]	Ampere Rating	10 k AIR	25 k AIR	65 k AIR	100 k AIR
 2P 240 Vac Maximum	Q22200NS [12] or Q23225NF/S	Q22200NRB [12] or Q23225NRB	19, 11R 20, 12R	70 A	QBL22070	QDL22070	QGL22070	QJL22070
				80 A	QBL22080	QDL22080	QGL22080	QJL22080
				90 A	QBL22090	QDL22090	QGL22090	QJL22090
				100 A	QBL22100	QDL22100	QGL22100	QJL22100
				110 A	QBL22110	QDL22110	QGL22110	QJL22110
				125 A	QBL22125	QDL22125	QGL22125	QJL22125
				150 A	QBL22150	QDL22150	QGL22150	QJL22150
				175 A	QBL22175	QDL22175	QGL22175	QJL22175
				200 A	QBL22200	QDL22200	QGL22200	QJL22200
				225 A	QBL22225	QDL22225	QGL22225	QJL22225
 3P 240 Vac	Q23225NF/S	Q23225NRB	20, 12R	70 A	QBL32070	QDL32070	QGL32070	QJL32070 [13]
				80 A	QBL32080	QDL32080	QGL32080	QJL32080 [13]
				90 A	QBL32090	QDL32090	QGL32090	QJL32090 [13]
				100 A	QBL32100	QDL32100	QGL32100	QJL32100 [13]
				110 A	QBL32110	QDL32110	QGL32110	QJL32110 [13]
				125 A	QBL32125	QDL32125	QGL32125	QJL32125 [13]
				150 A	QBL32150	QDL32150	QGL32150	QJL32150 [13]
				175 A	QBL32175	QDL32175	QGL32175	QJL32175 [13]
				200 A	QBL32200	QDL32200	QGL32200	QJL32200 [13]
				225 A	QBL32225	QDL32225	QGL32225	QJL32225 [13]

[4] See Table 1.73 Knockout Information, page 1-34

[5] Not suitable for service equipment.

[6] Maximum 10 hp 240 Vac.

[7] Top endwall has no hub opening.

[8] Maximum 20 hp 240 Vac.

[9] Not for use with one pole QO circuit breakers. Circuit breakers not included. Order QO type circuit breakers separately from pages 1-2 and 1-3. Accepts QO circuit breakers with factory-installed accessories. Order equipment ground bar PKOGTA2, if required.

[10] Order F for flush, S for surface.

[11] Factory-installed groundable neutral assembly includes (2) ground lugs and (2) neutral lugs. Equipment ground kit PKOGTA2 also included.

[12] Accepts 200 A max. 2P Q Frame circuit breakers.

[13] Equipment ground bar kit PKOGTA2 factory-included.

Table 1.101: QOM2 Enclosures and QOM2 Circuit Breakers

Service	Enclosure Only [14]			QOM2 Circuit Breaker (Order Separately) [15]	
	Type 1 General Purpose [16]	Type 3R Rainproof	Box No. [17]	Ampere Rating	22 k AIR
	Cat. No.	Cat. No.			Cat. No. [18]
 2P 240 Vac Maximum	QOM22225NF/S	QOM22225NRB	22, 16R	100 A	QOM2100VH
				125 A	QOM2125VH
				150 A	QOM2150VH
				175 A	QOM2175VH
				200 A	QOM2200VH
				225 A	QOM2225VH



QOM22225NS
With Cover Removed



Q22200NS
With Cover Removed



Q23225NF

(Order Q-Frame circuit breaker separately)

[14] Equipment ground bar kit PKOGTA2 factory-included.

[15] Add suffix 1021 for 120, 208 or 240 Vac shunt trip.

[16] Order F for flush, S for surface.

[17] See Table 1.73 Knockout Information, page 1-34

[18] DE3A Discount Schedule.