

I-Line™ Circuit Breaker Panelboards

Class 2110

Catalog

2110CT9701
R03/2023



Legal Information

The information provided in this document contains general descriptions, technical characteristics and/or recommendations related to products/solutions.

This document is not intended as a substitute for a detailed study or operational and site-specific development or schematic plan. It is not to be used for determining suitability or reliability of the products/solutions for specific user applications. It is the duty of any such user to perform or have any professional expert of its choice (integrator, specifier or the like) perform the appropriate and comprehensive risk analysis, evaluation and testing of the products/solutions with respect to the relevant specific application or use thereof.

The Schneider Electric brand and any trademarks of Schneider Electric SE and its subsidiaries referred to in this document are the property of Schneider Electric SE or its subsidiaries. All other brands may be trademarks of their respective owner.

This document and its content are protected under applicable copyright laws and provided for informative use only. No part of this document may be reproduced or transmitted in any form or by any means (electronic, mechanical, photocopying, recording, or otherwise), for any purpose, without the prior written permission of Schneider Electric.

Schneider Electric does not grant any right or license for commercial use of the document or its content, except for a non-exclusive and personal license to consult it on an "as is" basis.

Schneider Electric reserves the right to make changes or updates with respect to or in the content of this document or the format thereof, at any time without notice.

To the extent permitted by applicable law, no responsibility or liability is assumed by Schneider Electric and its subsidiaries for any errors or omissions in the informational content of this document, as well as any non-intended use or misuse of the content thereof.

Table of Contents

Product Description	5
Standards	5
Service	6
Panelboard Types	7
Enclosure Types.....	8
Main Circuit Breaker Panelboards.....	9
Main Lugs Only Panelboards.....	9
Universal Mains Panelboards	9
Solid Neutral	10
Features and Benefits	11
Circuit Breakers.....	11
Circuit Breaker Mounting	11
Push-to-Trip	11
Blow-On Connections	12
Short Circuit Current Rating (SCCR)	12
I-Line Plug-on Unit with Surgelocic™ SPD	12
Accessories	13
Equipment Ground Bars.....	13
Box Extensions	13
Blank Fillers/Extensions	14
Service Entrance Barriers	14
Drip Hoods.....	14
General and Application Information	15
Circuit Breaker Types.....	15
Wire Range Information.....	18
Branch or Group Mounted Main Circuit Breaker Terminal Data	19
Plug-On Lugs Terminal Data	20
Circuit Breaker Accessories	20
Plug-On QO™ Distribution Panel (Catalog No. HQO306).....	21
QO Distribution Panel Branch Circuit Breakers.....	21
I-Line Enable Modules	22
Product Description.....	23
Features	23
Protection Modules	24
Communication Modules	29
EcoStruxure Panel Server Module	33
Metering Modules	35
Power Meters	36
Dimensions for Standard NEMA Type 1 Enclosures	41
Type HCJ—800 A Maximum Main Lugs	41
Type HCJ 400 A Maximum Main Circuit Breaker	42
Type HCJ—800 A Maximum Main Circuit Breaker.....	43
Type HCP—800 A Maximum Main Lugs	44
Type HCP—1200 A Maximum Main Lugs	45
Type HCP—800 A Maximum Main Circuit Breaker	46
Type HCP-SU—800 A Maximum Main Circuit Breaker	47
Type HCR-U—1200 A Main Lugs or Main Circuit Breaker	48

I-Line Panelboard Estimated Weights	49
Appendix—Merchandise Unit Catalog Numbers	51
Glossary	53

Product Description

**Type HCR-U—
1200 A Main
Circuit Breaker**



Square D™-brand I-Line™ circuit breaker power distribution panelboards are for use on AC or DC systems. The panels, labeled cULus (compliance to UL and CSA standards certified by UL) are also Underwriters Laboratories® (UL®) Listed under File E33139. The following are suitable for use as service entrance equipment:

- All main circuit breaker panelboards. **Note:** Panelboards for US UL Service Entrance with vertical main circuit breaker must be factory-assembled only.
- All main lugs panelboards with branch-mounted, or group-mounted main circuit breaker. (For Canadian MLO service entrance, use HCP-SU and HCR-U only).
- All main lugs panelboards with six disconnects or less.
- A solid neutral that is insulated, but may be bonded to the box with a grounding strap.
- Service entrance panelboards meeting the requirements of CSA are available in Canada factory-assembled only.

I-Line circuit breaker panelboards are available as 400–1200 A main lugs only and 100–1200 A main circuit breakers. I-Line panelboards are designed to accept the following circuit breakers: BD, BG, BJ, BK, HD, HG, HJ, HL, HR, QB, QD, QG, QJ, JD, JG, JJ, JL, JR, LA, LG, LJ, LH, LL, LR, MG, MJ, PG, PJ, PK, PL, RG, RJ, RK, and RL.

Standards

**Type HCR-U—
1200 A
Main Circuit Breaker**



I-Line circuit breaker panelboards are designed, manufactured, and tested to comply with the following standards:

Standard	Description
UL 50	Standard for enclosures for electrical equipment
UL 67	Standard for panelboards
CSA C22.2, Nos. 29 and 94—1989	Standard for panelboards and enclosed panelboards
NFPA 70	National Electrical Code (NEC)
NEMA PB 1	Standard for panelboards
W-P 115C Type 1 Class 1	Specification for circuit breaker panelboards
IBC	US standard for seismic requirements
NBCC	Canadian standard for seismic requirements

Service

I-Line circuit breaker panelboards can be used on the following system voltages:

- 120/240 Vac; 1-phase, 3-wire, 60 Hz
- 240 Vac; 1-phase, 2-wire, 60 Hz
- 240/120 Vac; 3-phase, 4-wire, 60 Hz
- 240 Vac; 3-phase, 3-wire, 60 Hz
- 240 Vac Ground, B-phase; 3-phase, 3-wire, 60 Hz
- 208Y/120 Vac; 3-phase, 4-wire, 60 Hz
- 480Y/277 Vac; 3-phase, 4-wire, 60 Hz
- 480Y/277 Vac; 1-phase, 3-wire, 60 Hz
- 480 Vac; 3-phase, 3-wire, 60 Hz
- 600Y/347 Vac; 3-phase, 4-wire, 60 Hz
- 600 Vac; 1-phase, 2-wire, 60 Hz
- 600 Vac; 3-phase, 3-wire, 60 Hz
- 125/250 Vdc; 3-wire
- 48 Vdc; 2-wire
- 125 Vdc; 2-wire
- 250 Vdc; 2-wire
- International Voltages:
 - 220/110 Vac; 3-phase, 4-wire, 50/60 Hz
 - 220Y/127 Vac; 3-phase, 4-wire, 50/60 Hz
 - 230/115 Vac; 3-phase, 4-wire, 50/60 Hz
 - 380Y/220 Vac; 3-phase, 4-wire, 50/60Hz
 - 400Y/230 Vac; 3-phase, 4-wire, 50/60Hz
 - 415Y/240 Vac; 3-phase, 4-wire, 50/60 Hz
 - 480Y/277 Vac; 3-phase, 4-wire, 50 Hz
 - 600 Vac; 3-phase, 3-wire, 50 Hz
 - 600Y/347 Vac; 3-phase, 4-wire, 50 Hz
 - 110/220 Vac; 1-phase, 3-wire, 50/60 Hz
 - 115/230 Vac; 1-phase, 3-wire, 50/60 Hz
 - 127/220 Vac; 1-phase, 3-wire, 50/50 Hz

Panelboard Types

**Type HCP—600 A
Main Circuit Breaker**



Panel-board Type	Maximum Mains Ampacity		Maximum Branch Circuit Breaker Frame Size ¹		Enclosure Dimensions (NEMA Type 1) ²			
	Main Lugs	Main Circuit Breakers	Left	Right	Width		Depth [#]	
					in.	mm	in	mm
HCJ	800 A	800 A	JD	JD	32.00	813	9.50	241
HCP-SU	800 A	800 A ³	MG, PG	None	26.00	600	9.50	241
HCP	1200 A	800 A	MG, PG	JD	42.00	1067	9.50	241
HCR-U	1200 A	1200 A ³	RG	JD	44.00	1118	9.50	241

**Type HCR-U—
1200A Main Lugs**



**Type HCP-SU 800
A Main Circuit
Breaker**



Type HCJ—400 A Main Lugs



1. For a complete listing of applicable circuit breaker types, refer to Dimensions for Standard NEMA Type 1 Enclosures, page 41.
 2. Refer to Dimensions for Standard NEMA Type 1 Enclosures, page 41 for standard panelboard heights.
 3. Available as a main circuit breaker panelboard when provided with a group-mounted (back-fed) main circuit breaker.

Enclosure Types

Types 1 Enclosure with Optional Door



Flush Lock used on HCJ, and HCP-SU Types 1 and 2 Fronts (Catalog No. PK4FL)



Sliding Vault Lock used on HCP, and HCR-U Types 1 and 2 Fronts (Catalog No. PK5FL)



Types	Environments	Provides Protection Against
Type 1	Indoor	Contact with the enclosed equipment
Type 2	Indoor	Falling water and dirt
Type 3R	Outdoor	Falling rain, sleet; undamaged by ice
Type 4/4X Stainless	Indoor/Outdoor	Corrosion, hose-directed water, dust
Type 5	Indoor	Settling dust, falling dirt, dripping liquids
Type 12	Indoor	Circulating dust, falling dirt, dripping liquids

Type 1 and 2⁴ Enclosures	Fronts:	HCJ, HCP, HCP-SU, and HCR-U surface and flush trims available as four-piece construction, standard (door not included). An optional four-piece trim with door is also available. An optional hinged trim with door is also available.
		Finished with gray-baked enamel electrodeposited over cleaned phosphatized steel (ANSI 49).
		Directory card holders provided with all fronts.
	Boxes:	Galvanized steel in 26, 32, 42, and 44-inch (660, 813, 1067, and 1118 mm) widths.
		Removable endwalls without knockouts.
Type 3R, 5, and 12 Enclosures		Gasketed door with vault handle and directory card holder.
		Three-point latching.
		End and side gutter trim.
		No knockouts.
		Removable drain screw for Type 3R.
		Finished with gray-baked enamel electrodeposited over cleaned phosphatized steel (ANSI 49).
Type 4X Enclosures (Factory-Assembled Only)		Corrosion-resistant, stainless steel (available in Type 304 or 316L stainless steel).
		Watertight and dusttight.
		Gasketed door.
		Directory card located on inside of door.

Type 3R, 5, and 12 Enclosures



Type 3R, 5, and 12 Enclosures



Vault Handle used on all Type 3R, 5, and 12 Enclosures (Catalog No. PK4NVL)



4. Type 2 includes an optional drip hood.

Main Circuit Breaker Panelboards

Main Circuit Breaker and Solid Neutral Compartment (Canada service entrance not shown)



- Accept a maximum 1200 A, 80% or 100% rated main breaker.
- Available factory-assembled or merchandised.
- Factory-assembled main circuit breaker interiors are available bottom-feed or top-feed.
- Suitable for use as service entrance equipment with appropriate barriers, US and Canada. (**Note:** Available as be factory-assembled only)
- Accepts mechanically restrained I-Line circuit breakers.
- Available with a short circuit current rating (SCCR) up to 200 kA maximum (100 kA @ 600 Vac) when supplied by an I-Limiter™ circuit breaker.
- Standard bus is tin plated copper (800 A and above) or tin plated aluminum (600 A and below). Options for silver plating and copper bus below 800 A are available.
- Solid neutral is mounted in the mains compartment with the main circuit breaker.
- Merchandised panelboards are provided as bottom-feed.

Main Lugs Only Panelboards

Main Lug and Solid Neutral Compartment



- Available with main lug only interiors rated up to 1200 A.
- Available factory-assembled or merchandised.
- Suitable for use as service entrance equipment when provided with a main circuit breaker, US and Canada.
- Accepts mechanically restrained I-Line circuit breakers.
- Available with a short circuit current rating (SCCR) up to 200 kA maximum (100 kA @ 600 Vac) when supplied by an I-Limiter circuit breaker.
- Standard bus is tin plated copper (800A and above) or tin plated aluminum (600 A and below). Options for silver plating and copper bus below 800 A are available.
- Solid neutral is mounted in the mains compartment with the main lugs.
- Hinged cover, isolated main lugs compartment.
- Main lug interiors are available as top-feed or bottom-feed.

Universal Mains Panelboards



- Universal mains utilize a group mounted circuit breaker or sub feed lug as a main incoming device
- Available up to 1200 A.
- Available factory-assembled or merchandised.
- Available with US or Canadian Service Entrance barriers.
- Accepts mechanically restrained I-Line circuit breakers.
- Available with a short circuit current rating (SCCR) up to 200 kA maximum (100 kA @ 600 Vac) when supplied by an I-Limiter circuit breaker.
- Standard bus is tin plated copper. Option for silver plating is available.
- Solid neutral is available.
- Available as top-feed or bottom-feed by locating the main at top or bottom of the bus stack.

Solid Neutral

- Mounts in main lug or main circuit breaker compartment.
- Does not take up interior circuit breaker mounting space.
- UL/CSA Listed for use with Al or Cu conductors.
- Copper or aluminum neutral available.
- 200% rated neutral available as a factory-assembled option.
- Expanded neutral capacity is available to accommodate more neutral terminals and sizes. Available in Al or Cu. The number of neutral terminations are expanded as needed on factory assembled panelboards, based on circuit breaker type and count. Expanded neutrals are also available as merchandise kits (see Digest section 9).

Typical Solid Neutral

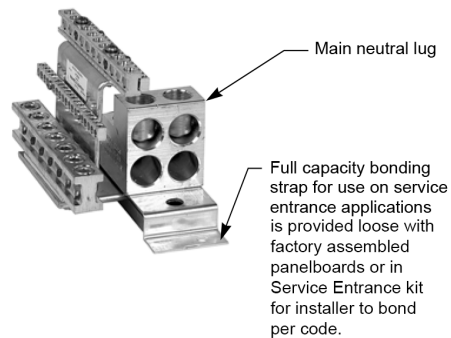

Typical Solid Neutral with Neutral Current Transformer for Ground Fault Protection



Features and Benefits

Featured below are just a few of the many features and benefits of Square D™ brand I-Line™ circuit breaker panelboards.

Circuit Breakers

I-Line circuit breakers, with their exclusive bus connection design, provide superior reliability and performance advantages.

Circuit Breaker Mounting

Ratchet-Type Mounting

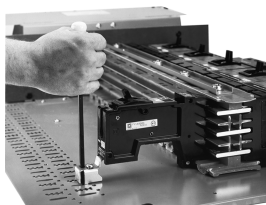

- 15–1200 A frame circuit breakers require only a screwdriver and are firmly attached to the bus stack and mechanically attached to the interior assembly.
- The connectors are an integral part of the I-Line circuit breaker—eliminating the assembly of connectors to the bus bar.
- Pre-assembled hardware means reduced installation time.
- The unique line side connection requires no routine maintenance.

I-Line Bus Structure and Circuit Breaker Mounting

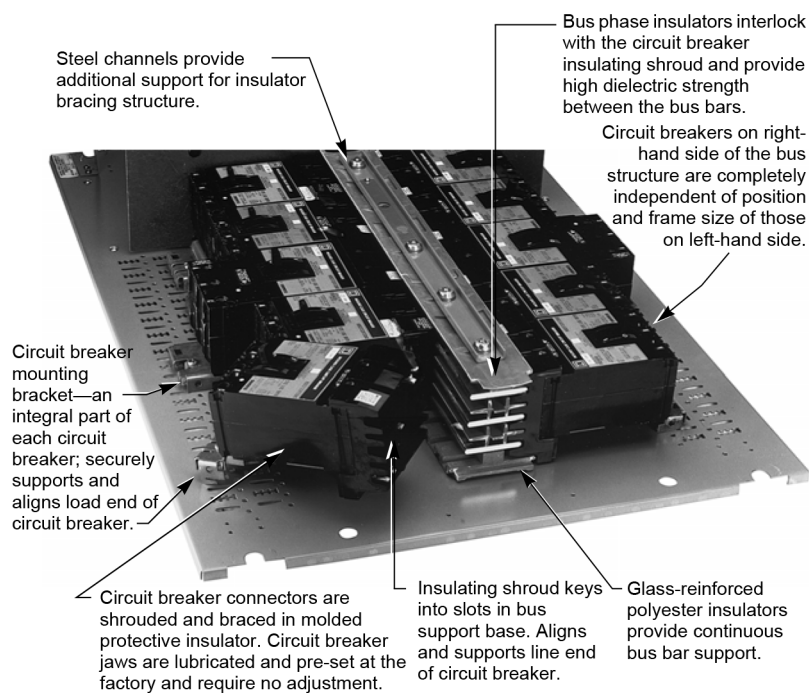

Push-to-Trip

Push-to-trip is a standard feature on all I-Line circuit breakers. It is useful for checking circuit breaker operation and for testing auxiliary devices. The circuit breaker is mechanically tripped by pressing the push-to-trip button in the circuit breaker case.

Blow-On Connections

Blow-On Connections

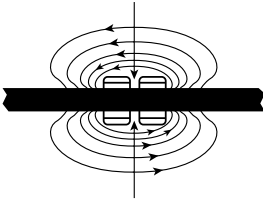

All circuit breaker connections are “blow-on” type. Under high-level short circuit conditions, the magnetic forces developed tend to draw the connector jaws together, gripping the I-Line bus bar more firmly.

Short Circuit Current Rating (SCCR)

- SCCR is equal to the lowest interrupting capacity of a branch or main circuit breaker installed in the panelboard.
- I-Line panelboards, with branch circuit breakers installed, are short-circuit tested as complete units.
- All tests are conducted in accordance with UL 67 and CSA C22.2 (Standards for Panelboards).

With I-Limiter main circuit breaker, I-Line main circuit breaker panelboards are UL/CSA Listed for use on systems with up to a 200,000 maximum RMS symmetrical amperes available fault current (100 kA @ 600 Vac).

I-Line Plug-on Unit with Surgeologic™ SPD

I-Line Plug-On Unit with Surgeologic SPD



- SPD requires no wiring or conduit, saving labor time and materials.
- Bus-connected design enhances performance.
- Meets the requirements of UL and CSA for retrofit applications in existing I-Line panelboards and switchboards.
- Integrated and circuit breaker disconnects feature compact design, requiring only 13.50 inches (343 mm) of branch mounting space.
- SCCR up to 200 kA rating (100 kA @ 600 Vac) meets a wide variety of customer applications.
- SPD Surge Current ratings from 100 kA to 240 kA are available.
- Audible alarm with enable/disable switch, dry contacts and surge counter standard
- Indicator LEDs
- EMI/RFI filtering

Accessories

A wide variety of accessories are available for field or factory installation of I-Line panelboards.

Equipment Ground Bars

Equipment Ground Bar
(Catalog No.
PK32DGTA)

Equipment ground bars mount in the panelboard box to provide convenient termination of equipment grounding conductors. They are available in copper or aluminum.

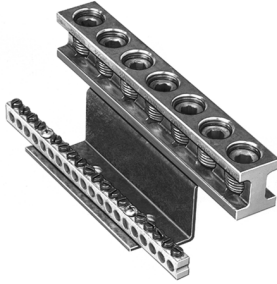

Box Extensions

Typical Box Extensions

Box extensions provide additional end gutter for feeding cables into the end of the cabinet; they are UL/CSA Listed. Several extension heights are available as add-on kits in the field as shown below. In addition custom extensions are available in Factory Assembled panelboards.



Interior Type	Extension
HCP-SU	9 in.
HCJ	9 in.
HCP	12 in.
HCR-U	6 in.
HCR-U	12 in.

Blank Fillers/Extensions

Blank Fillers (Catalog Nos.

HNM4BL Qty. 5 per box
and HNM1BL Qty. 3 per
box)



Blank fillers are required to cover unused mounting space in I-Line panelboards. Blank Extensions are used to fill the gap between the filler or circuit breaker and the panelboard deadfront.

Blank Extensions



Service Entrance Barriers

Panelboards are suitable for use as service equipment if equipped with an integral main circuit breaker and service entrance barrier kit. Vertical mains or group mounted mains can be a service entrance main circuit breaker. There are separate Service Entrance Barrier versions available for US and Canada. In the US, under the 2017 UL67 and NFPA70 standards there is an exception when not more than six main disconnecting means are provided and the panelboard is not used as a lighting and appliance branch circuit panelboard that service entrance barriers are not required. The 2020 edition of the US National Electrical Code (NEC) no longer allows two to six service disconnecting means to be in the same panelboard enclosure thereby eliminating the above exception for states that have adopted the 2020 NEC.

Note: Service Entrance option for Canada must be installed in the SE factory per Canadian Codes.

Drip Hoods

Drip Hood



Primarily used for NEMA 2 applications in Canada these hoods are intended for use on surface mounted boxes only. The Drip Hoods are designed to fit on the outside of the boxes. The Drip Hood will increase the enclosure rating of the box from Type 1 to Type 2. Reference Instruction Bulletin 80043-401-03.

General and Application Information

Circuit Breaker Types

BD, BG, BJ, BK
1-, 2-, and 3-Pole; 15–125 A
(BK is 15–30 A)



QB, QD, QG, QJ
2- and 3-Pole; 70–225 A



HD, HG, HJ, HL
2- and 3-Pole; 15–150 A



JD, JG, JJ, JL
2- and 3-Pole; 150–250 A



MG, MJ
2- and 3-Pole; 300–800 A



PG, PJ, PK, PL
2- and 3-Pole; 250–1200 A



RG, RJ, RK, RL
2- and 3-Pole; 1000–1200 A



Circuit Breaker Frame Type	Maximum Voltage Rating	Number of Poles	Cont. Ampere Rating	UL/CSA Interrupting Rating—RMS Amperes (Symmetrical)					
				AC Volts, 50/60 Hz				DC Volts	
				120	240	480	600	125	250
BD	600 Y	1, 2, 3	15–125	25 K	25 K	18 K	14 K	—	—
BG	600 Y	1, 2, 3	15–125	65 K	65 K	35 K	18 K	—	—
BJ	600 Y	1, 2, 3	15–125	100 K	100 K	65 K	25 K	—	—
BK	600 Y	1, 2	15–30	100 K	100 K	65 K	65 K	—	—
HD	600	2, 3	15–150	25 K	25 K	18 K	14 K	20 K	20 K
HG	600	2, 3	15–150	65 K	65 K	35 K	18 K	20 K	20 K
HJ	600	2, 3	15–150	100 K	100 K	65 K	25 K	20 K	20 K
HL	600	2, 3	15–150	125 K	125 K	100 K	50 K	20 K	20 K
HR	600	3	15–150	200 K	200 K	200 K	100 K	—	—
QB	240	2, 3	70–225	10 K	10 K	—	—	—	—
QD	240	2, 3	70–225	25 K	25 K	—	—	—	—
QG	240	2, 3	70–225	65 K	65 K	—	—	—	—
QJ ⁵	240	2, 3	70–225	100 K	100 K	—	—	—	—
JD	600	2, 3	150–250	25 K	25 K	18 K	14 K	20 K	20 K
JG	600	2, 3	150–250	65 K	65 K	35 K	18 K	20 K	20 K
JJ	600	2, 3	150–250	100 K	100 K	65 K	25 K	20 K	20 K
JL	600	2, 3	150–250	125 K	125 K	100 K	50 K	20 K	20 K
JR	600	2, 3	150–250	200 K	200 K	200 K	100 K	—	—
LA	600	2, 3	125–400	42 K	42 K	30 K	22 K	10 K	10 K
LH ⁶	600	2, 3	125–400	65 K	65 K	35 K	25 K	—	50 K
LG	600	2, 3	250–600	65 K	65 K	35 K	18 K	—	20 K
LJ	600	2, 3	250–600	100 K	100 K	65 K	25 K	—	—
LL	600	2, 3	250–600	125 K	125 K	100 K	50 K	—	20 K
LR	600	2, 3	250–600	200 K	200 K	200 K	100 K	—	—
MG	600	2, 3	300–800	65 K	65 K	35 K	18 K	—	—
MJ	600	2, 3	300–800	100 K	100 K	65 K	25 K	—	—
PG	600	2, 3	600–1200	65 K	65 K	35 K	18 K	—	—
PJ	600	2, 3	600–1200	100 K	100 K	65 K	25 K	—	—
PK ⁷	600	2, 3	600–1200	65 K	65 K	50 K	50 K	—	—
PL	480	2, 3	600–1200	125 K	125 K	100 K	25 K	—	—
RG	600	2, 3	1000–1200	65 K	65 K	35 K	18 K	—	—
RJ	600	2, 3	1000–1200	100 K	100 K	65 K	25 K	—	—
RK ⁷	600	2, 3	1000–1200	65 K	65 K	65 K	65 K	—	—
RL	600	2, 3	1000–1200	125 K	125 K	100 K	50 K	—	—

Full circuit breaker ratings can be found in the following breaker catalogs:

B-Frame—0611CT1603

H/J/L- Frame—0611CT1001

M/P/R-Frame—0612CT0101

5. QJ 3-pole is rated 100 KA@208Y/120 Vac.
 6. Separate UL rating available for 240 V and 480 V grounded B phase systems. Circuit breakers must be ordered with 5861 suffix.
 7. For use in Canada Only

Q-Frame—0734CT0201

Please refer to Digest Section 9 for further circuit breaker selection information and catalog numbers.

Wire Range Information

Table 1 - Main Lug and Vertical Main Circuit Breaker Lug Quantities and Sizes (Standard Mechanical Lugs)

Mains Ampere Rating	Main Lugs		Vertically Mounted Main Circuit Breaker	
	Actual Lug Size ⁸	Maximum Allowed Cable Size Per UL/CSA Wire Bending Space	Actual Lug Size ⁸	Maximum Allowed Cable Size Per UL/CSA Wire Bending Space
Mechanical Lug Sizes				
100	—	—	(1) #14-1/0 Al/Cu	(1) #14-#1 Al/Cu
225	(1) #6-300 kcmil Al/Cu	(1) #6-300 kcmil Al/Cu	(1) #4-300 kcmil Al/Cu	(1) #4-300 kcmil Al/Cu
400	(2) #2-600 kcmil Al/Cu	(1) #2-600 kcmil Cu or (2) #2-500 kcmil Al/Cu	(1) #1-600 kcmil Al/Cu (2) #1-250 kcmil Al/Cu	(1) #1-600 kcmil Cu or (2) #1-250 kcmil Al/Cu
600	(2) #2-600 kcmil Al/Cu	(2) #2-500 kcmil Al/Cu	(3) 3/0-500 kcmil Al/Cu	(3) 3/0-500 kcmil Al/Cu
800	(4) 3/0-750 kcmil Al/Cu	(3) 3/0-500 kcmil Al/Cu	(4) 3/0-500 kcmil Al/Cu	(3) 3/0-500 kcmil Al/Cu
1200	(4) 3/0-750 kcmil Al/Cu	(4) 3/0-500 kcmil Al/Cu	(4) 3/0-600 kcmil Al/Cu	(4) 3/0-500 kcmil Al/Cu
Compression Lug Sizes				
225	(1) #4-300 kcmil Al/Cu	(1) #4-300 kcmil Al/Cu	(1) #4-300 kcmil Al/Cu	(1) #4-300 kcmil Al/Cu
400	(1) 2/0-500 kcmil Al/Cu or (1) 500-750 kcmil Al or (2) #4-300 kcmil Al/Cu	(1) 2/0-500 kcmil Al/Cu or (1) 500-750 kcmil Al or (2) #4-250 kcmil Al/Cu	(1) 500 kcmil Cu or (1) 500-750 kcmil Al	(1) 500 kcmil Cu or (1) 500-750 kcmil Al
600	(2) 2/0-500 kcmil Al/Cu	(2) 2/0-500 kcmil Al/Cu	(2) 2/0-500 kcmil Al/Cu	(2) 2/0-500 kcmil Al/Cu
800	(3) 2/0-500 kcmil Al/Cu	(3) 2/0-500 kcmil Al/Cu	(2) 500 kcmil Cu or (2) 500-750 kcmil Al	(2) 500 kcmil Cu or (2) 500-750 kcmil Al
1200	(4) 500 kcmil Cu or (4) 500-750 kcmil Al	(4) 500 kcmil Cu or (4) 600 kcmil Al	—	—

NOTE: All lugs are suitable for 75°C wire. Torque values are included on the neutral diagram.

Solid Neutral, Standard and Expanded Lug Quantities and Sizes (Standard Mechanical Lugs)

Panel Type	Amps	Solid Neutral Assembly Terminal Wire Range
HCJ	225	(1) 6 - 300, (9) #1/0 - 14, (45) #4 - 14
	400	(7) 6 - 350, (45) #4 - 14
	600	(7) 6 - 350, (9) #1/0 - 14, (28) #4 - 14
	800	(7) 6 - 350, (9) #1/0 - 14, (34) #4 - 14
HCP	400	(2) 4 - 600, (7) 6 - 350, (45) #4 - 14
	600	(4) 3/0 - 750, (7) 6 - 350, (9) #1/0 - 14, (34) #4 - 14
	800	(4) 3/0 - 750, (7) 6 - 350, (9) #1/0 - 14, (34) #4 - 14
	1200	(4) 3/0 - 750, (7) 6 - 350, (9) #1/0 - 14, (34) #4 - 14
HCP-SU	800	(4) 3/0 - 750, (7) 6 - 350, (9) #1/0 - 14, (34) #4 - 14
HCR-U	1200	(4) 3/0 - 750, (7) 6 - 350, (9) #1/0 - 14, (34) #4 - 14
	1200	(7) 6 - 350, (9) #1/0 - 14, (34) #4 - 14

8. These wire ranges may require a box extension to meet UL/CSA wire bending requirements. Do not use for standard panelboard purposes. Only the wires sizes and counts as shown in the column immediately to the right are available in the standard dimensioned panelboard. Contact factory any time cable requirements do not match standard panelboard to determine box size needed.

Branch or Group Mounted Main Circuit Breaker Terminal Data

Circuit Breaker	Frame Size	Ampere Rating	Terminal Lug Wire Size
BD, BG, BJ	125 A	15–125	#14–2/0 Al/Cu
BK	125 A	15–30	#14–2/0 Al/Cu
HD, HG, HJ, HL, HR	150 A	15–150	#14–3/0 Al/Cu
QB, QD, QG, QJ	225 A	70–225	#4–300 kcmil Al/Cu
JD, JG, JJ, JL	250 A	150–175	#4–4/0 Al/Cu
JD, JG, JJ, JL, JR	250 A	200–250	#3/0–350 kcmil Al/Cu
LA, LH	400 A	125–400	(1) #1–600 kcmil or (2) #1–250 kcmil Al/Cu
LG, LJ, LL, LR	400 A	250	(1) #2–600 kcmil CU or (1) #2–500 kcmil AL
LG, LJ, LL, LR	600 A	400–600	(2) #2–500kcmil AL/CU
MG, MJ	800 A	300–800	(3) 3/0–500 kcmil Al/Cu ⁹
PG, PJ, PK ¹⁰ , PL	1200 A	250–800	(3) 3/0–500 kcmil Al/Cu ⁹
PG, PJ, PK ¹⁰ , PL	1200 A	1000–1200	(4) 3/0–500 kcmil Al/Cu
RG, RJ, RK ¹⁰ , RL	1200 A	1000–1200	(4) 3/0–600 kcmil Al/Cu

NOTE: Lugs are rated for 75°C wire. Torque values are listed on the circuit breaker faceplate tables.

9. On HCP/HCP-SU type interiors a Side Extension is required for the optional (4) 3/0 -500 kcmil or (2) 3/0 -750kcmil lug sizes. Contact factory.
 10. For use in Canada Only

Plug-On Lugs Terminal Data

(used as either a subfeed lug or on Universal Panelboards as a back fed main lug)

Plug-On Lugs

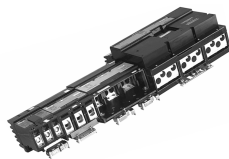

Amperage Rating	Frame Size	Catalog No.	Terminal Lug Wire Size
250 A	250 A	SL250	(1) #4-300 kcmil Al/Cu
400 A	400 A	SL400	(1) #1-600 kcmil Al/Cu or (2) #1-250 kcmil Al/Cu
800 A	800 A	SL800M5	(3) 3/0 AWG-500 kcmil
1200 A	1200 A	SL1200P5	(4) 3/0 AWG-500 kcmil
1200 A	1200 A	SL1200P6	(3) 350-600 kcmil
1200 A	1200 A	SL1200P7	(3) 3/0 AWG-750 kcmil (750 kcmil: Compact Al only)
1200 A ¹¹	1200 A	S33930	(4) 3/0-600 kcmil Al/Cu

Circuit Breaker Accessories

- Shunt trip
- Undervoltage trip
- Alarm switch
- Auxiliary contacts
- Ground-fault shunt trip

NOTE: All accessories, except for the Ground-fault shunt trip are field installable for LA, LH circuit breakers.

For detailed information on circuit breakers and accessories, refer to the Digest.

Circuit Breaker	Digest Table Number
HD, HG, HJ, HL	7.99, 7.100
QB, QD, QG, QJ	7.100
JD, JG, JJ, JL	7.99, 7.100
LA, LH	7.61
LG, LJ, LL, LR	7.99, 7.100
MG, MJ	7.99, 7.100
PG, PJ, PK ¹² , PL	7.99, 7.100
RG, RJ, RK ¹² , RL	7.99, 7.100

11. For 100% rated applications ("R" frame breakers).
 12. For use in Canada Only

Plug-On QO™ Distribution Panel (Catalog No. HQO306)

QO with Visi-Trip™ Indicator 1-, 2-, and 3-Pole



- Six-pole, 240 Vac maximum
- Use with QO, QO-H, QO-VH, QH, and Qwik-Gard™ plug-on circuit breakers through 30 A. For detailed information, refer to DP Catalog Class 730 and 910.
- Mounts in all I-Line panelboards.

QO Distribution Panel Branch Circuit Breakers

Qwik-Gard Circuit Breaker with Ground Fault Circuit Interrupter



Distribution Channel Type	Number of Poles & Amperages
10 k AIR, QO	1-Pole 10–30 A
	2-Pole 10–30 A
	3-Pole 10–30 A
10 k AIR, QO-GFI	1-Pole 15–30 A ¹³
	2-Pole 15–30 A ¹³
22 k AIR, QO-VH	1-Pole 15–30 A
	2-Pole 15–30 A
	3-Pole 15–30 A
22 k AIR, QO-VHGFI	1-Pole 15–30 A ¹³
65 k AIR, QH	1-Pole 15–30 A
	2-Pole 15–30 A
	3-Pole 15–30 A

13. Maximum of three GFI-suffix circuit breakers can be installed.

I-Line Enable Modules

I-Line Enable Modules (formerly known as Smart Cells) are a space-saving module for value-added digital solutions. The self-contained unit fits onto the I-Line bus taking up only a 6-inch circuit breaker mounting space and using the same mounting as a circuit breaker. This allows the I-Line panelboard to be transformed into a digital communication or metered electrical distribution solution with enhanced protection now or in the future.

I-Line Enable modules are available for:

- IFM Modbus serial network communications interface
- Energy Reduction Maintenance Setting (ERMS)
- Maintenance Mode Switch (MMS)
- PM5563 or PM8244 meter with or without communications
- Universal Panel Server Gateway & Data Logger for Ethernet networking or cloud-based solutions

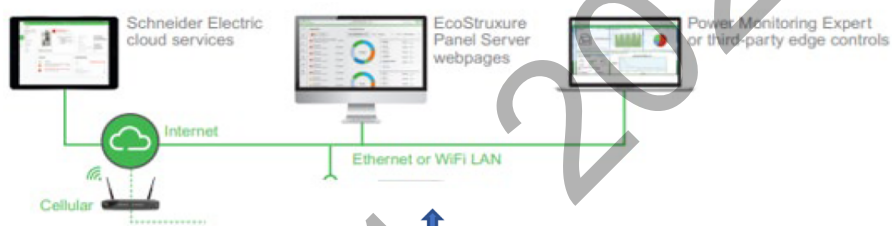

Enable Connectivity

- Modbus Serial Communication to breakers
- Ethernet TCP/IP Communication to network
- Universal Panel Server Gateway & Data Logger to network/cloud

Enable Protection

- Maintenance Mode Switch (MMS)
- Energy Reducing Maintenance Switch (ERMS)

Enable Metering/Monitoring

- PM5563 Basic, Multifunction Meter
- PM8244 Multifunction, Advance Power Quality Meter



Product Description

I-Line Enable modules are compact, self-contained plug-on devices intended for installation on I-Line panelboard bus. Each module includes I-Line stab power connections for module functions as well as 24Vdc connections for trip units of connected circuit breakers. A main power disconnect with fuses is provided to de-energize main power and for short circuit protection of the unit. An interface is provided on the front of some of the units for an RJ45 Ethernet programming (Meters/U-PaS) via connected computer.

Narrow side I-Line Enable modules can only be installed on the narrow side of HCJ, HCP, and HCR I-Line Panelboards, as well as Switchboard QED2 I-Line Distribution Section. Wide side I-Line Enable modules can be installed on the wide side of HCP, HCPSU, HCR I-Line Panelboards, as well as Switchboard QED2 I-Line Distribution Section. I-Line Enable module placement in the Panelboard is typically directly above the related MAIN or feeder circuit breaker.

The I-Line Enable modules can be included in Square D I-Line factory assembled equipment or ordered individually for field installations such as Retrofit or RTI. For more information refer to Handout (998-22301121_US) or User Guide (JYT97577).

Typical Layout for I-Line Enable module (U-PaS for Wide Side Left shown)

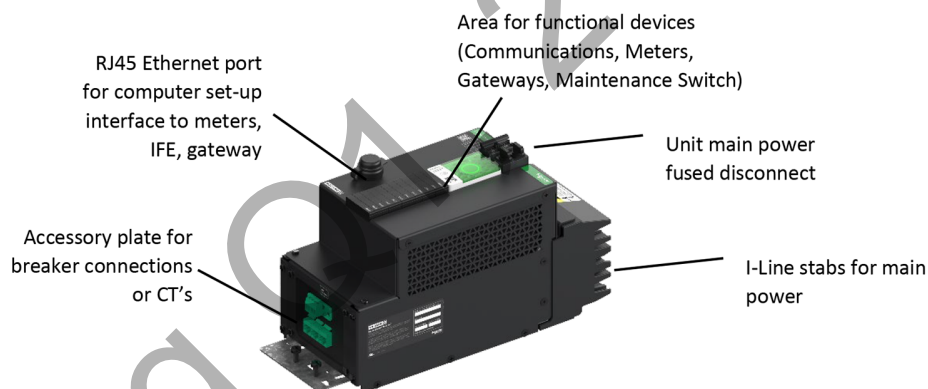

Features

Modular design

- Space-saving design significantly reduces carbon footprint and fits onto the I-Line bus in place of a circuit breaker; eliminating the need for an I-Line panelboard box extension
- Easy to install; a screwdriver is all that's needed to mount I-Line Enable Module; mounts firmly onto the bus stack and fastens with captive retaining screws
- Minimizes impact of project changes, allowing customers to add components to an I-Line panelboard after shipment or for future upgrade.
- I-Line Enable Module is available in factory-assembled panelboards as well as ready-to-install (RTI) for new and retrofit applications

Reduced exposure

- On models with Ethernet communications, front access makes checking breaker meter values and maintenance details quicker and safer than ever
- On meter models, branch level metering is integrated into the panelboard, no need to remove trim to access meter points

Integration of value-added devices

- Easily integrate digital solutions without increasing equipment footprint

- Reduce retrofit installation costs with a quick install I-Line Enable Module meter options

NOTE: Uses 6 inches of bus space, the same as an L-frame circuit breaker.

Protection Modules

Energy Reduction Maintenance Setting (ERMS) meets NEC 2014 code (Section 240.87) requirements and reduces arc energy during maintenance to improve electrical personnel safety. ERMS trip setting offers electronic adjustability for coordination (factory-assembled only). Consists of two-position ON-Off selector switch and I/O module of interface with P/R frame circuit breakers equipped with Micrologic 5.0 or higher P or H trip units. 24 Vdc power supply for I/O module and breaker trip unit is provided for customer to wire. Several versions are available and include Ethernet Modbus TCP/IP communications connections or Modbus Serial communications connections. See table below for standard number of connections and additional connections available with field additions.

ERMS module shown, Wide Left



Catalog Number	Voltage Vac	Features	Number of circuit breakers unit will communication to as standard	Additional number of circuit breakers unit can communicate to with Field Kit* added	Total possible number of communicating circuit breakers per module
ICWL2222ERMS	120-240	For Mounting on Wide Side, when Wide side of I-Line panelboard is mounted on Left, ERMS - Ethernet communications	1	0	1
ICWR2222ERMS	120-240	For Mounting on Wide Side, when Wide side of I-Line panelboard is mounted on Right, ERMS - Ethernet communications	1	0	1
ICWL2422ERMS	277-480	For Mounting on Wide Side, when Wide side of I-Line panelboard is mounted on Left, ERMS - Ethernet communications	1	0	1
ICWR2422ERMS	277-480	For Mounting on Wide Side, when Wide side of I-Line panelboard is mounted on Right, ERMS - Ethernet communications	1	0	1
ICWL2222ERM2	120-240	For Mounting on Wide Side, when Wide side of I-Line panelboard is mounted on Left, ERMS - Modbus communications	2	2 (IFMs)	4
ICWR2222ERM2	120-240	For Mounting on Wide Side, when Wide side of I-Line panelboard is mounted on Right, ERMS - Modbus communications	2	2 (IFMs)	4
ICWL2422ERM2	277-480	For Mounting on Wide Side, when Wide side of I-Line panelboard is mounted on Left, ERMS - Modbus communications	2	2 (IFMs)	4
ICWR2422ERM2	277-480	For Mounting on Wide Side, when Wide side of I-Line panelboard is mounted on Right, ERMS - Modbus communications	2	2 (IFMs)	4

Catalog Number	Voltage Vac	Features	Number of circuit breakers unit will communication to as standard	Additional number of circuit breakers unit can communicate to with Field Kit* added	Total possible number of communicating circuit breakers per module
ICWL2622ERM2	600	For Mounting on Wide Side, when Wide side of I-Line panelboard is mounted on Left, ERMS - Modbus communications	1	0	1
ICWR2622ERM2	600	For Mounting on Wide Side, when Wide side of I-Line panelboard is mounted on Right, ERMS - Modbus communications	1	0	1

***Kits for IFM Install**

(Refer to Instruction Bulletin JYT97577 for details regarding expanding the module using IFM Kits)

Part Number	Description
ICIFM1	IFM Kit (Qty 1)
ICIFM5	IFM Kit (Qty 5)

NOTES:

- When ERMS is installed, Zone Selective Interlocking (ZSI) cannot be used on the same breaker.
- The P/R frame circuit breakers should be equipped with LSI or LSI^G features and Micrologic trip units 5.0/6.0, P/H.
- MMS or ERMS/ERM2 is required per NEC for a Panelboard that utilizes a 1200 A Main circuit breaker or larger. It is optional on circuit breakers smaller than 1200 A.
- ERMS is not available with H/J/L frame circuit breakers.
- ERMS can be applied to back-fed main breakers and branch breakers.
- Each P/R frame circuit breaker to be used with the ERMS Smart Cell will require the suffix E1.
- Each breaker to be communicated with will require an NSX Cord and BSCM communication module. See schematic below.
 - □ P/R NSX Cord (0.35m) = LV434195
 - □ P/R NSX Cord (1.35m) = LV434196
 - □ P/R NSX Cord (3.00m) = LV434197
 - □ P/R Breaker BSCM (replacement unit) =S64205
- ERM2 modules contains two IFMs for 480 V or less versions and one IFM for 600 V versions. One of the IFMs is used to communicate to the MAIN breaker that is utilizing the ERMS functionality. The second IFM and any additional IFMs added by Field Kits is for communication to additional circuit breakers, preferably an H/J/L Frame version.
- I-Line Enable Communication modules from Communication Modules section below can be added to the panel to provide space for more circuit breaker communication connections.

ERMS Communication Schematic Diagram

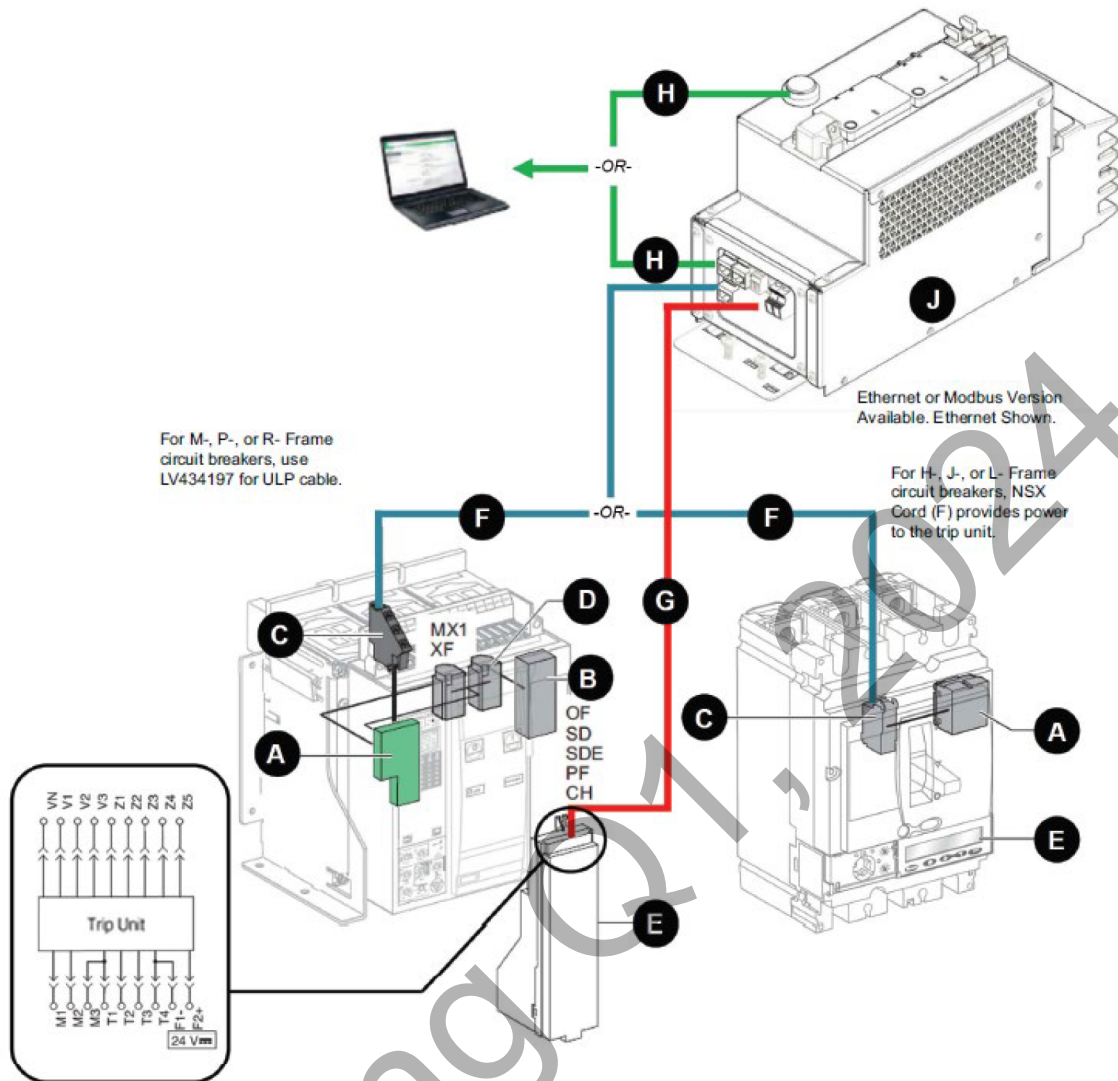

Maintenance Mode Setting (MMS) switch can be used to temporarily reduce the short-time delay setting of a Powerpact P/R-frame circuit breaker. MMS meets the National Electrical Code (NEC) 240.87 requirements for arc flash reduction. The switch can reduce a short-time delay (STD) setting from 0.3 seconds to 0.08 seconds or less. For an MMS-controlled circuit breaker to be effective for arc-flash reduction, the circuit breaker short-time current pickup setting (considering positive tolerance) must be set below 85% of the minimum arcing current at the system location where it is expected to provide "fast" interruption (considering all fault current scenarios in an arc flash study).



Catalog Number	Voltage Vac	Features
ICNL2222MMS	120–240	For Mounting on Narrow Side, when Narrow side of I-Line panelboard is mounted on Left, Maintenance Mode Switch
ICNR2222MMS	120–240	For Mounting on Narrow Side, when Narrow side of I-Line panelboard is mounted on Right, Maintenance Mode Switch
ICNL2422MMS	277–480	For Mounting on Narrow Side, when Narrow side of I-Line panelboard is mounted on Left, Maintenance Mode Switch
ICNR2422MMS	277–480	For Mounting on Narrow Side, when Narrow side of I-Line panelboard is mounted on Right, Maintenance Mode Switch
ICWL2222MMS	120–240	For Mounting on Wide Side, when Wide side of I-Line panelboard is mounted on Left, Maintenance Mode Switch
ICWR2222MMS	120–240	For Mounting on Wide Side, when Wide side of I-Line panelboard is mounted on Right, Maintenance Mode Switch
ICWL2422MMS	277–480	For Mounting on Wide Side, when Wide side of I-Line panelboard is mounted on Left, Maintenance Mode Switch
ICWR2422MMS	277–480	For Mounting on Wide Side, when Wide side of I-Line panelboard is mounted on Right, Maintenance Mode Switch
ICWL2622MMS	600	For Mounting on Wide Side, when Wide side of I-Line panelboard is mounted on Left, Maintenance Mode Switch
ICWR2622MMS	600	For Mounting on Wide Side, when Wide side of I-Line panelboard is mounted on Right, Maintenance Mode Switch

- MMS only available on PowerPact P/R frame circuit breakers equipped with Micrologic 5.0/6.0 A, P or H trip units.
- When MMS is installed, Zone Selective Interlocking (ZSI) cannot be used on the same circuit breaker.
- MMS or ERMS/ERM2 is required for a Panelboard that utilizes a 1200 A Main circuit breaker. It is optional on circuit breakers smaller than 1200 A.
- MMS is not available on H/J/L frame circuit breakers.
- MMS can be applied to back-fed main circuit breakers and branch circuit breakers.
- Refer to MFR70008 – Maintenance Mode Switch (MMS) Installation Instructions.

MMS Communication Schematic Diagram

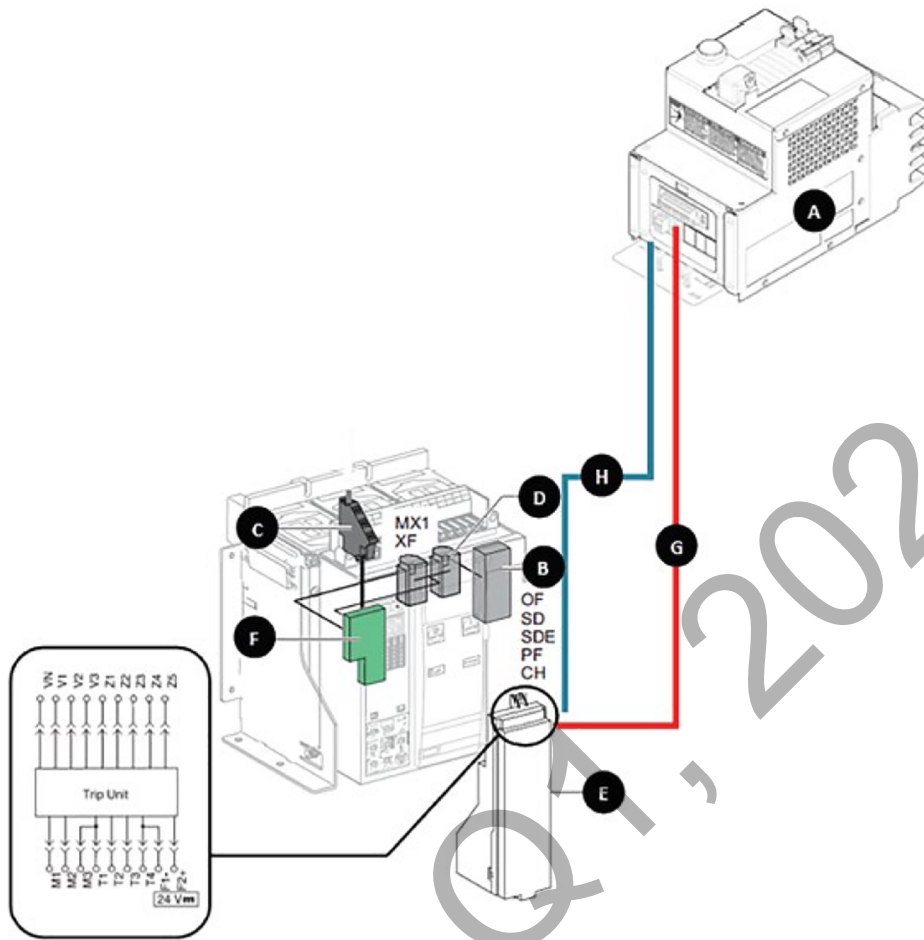

Communication Modules

I-Line Enable Communications Modules facilitate Ethernet connected electrical distribution devices to help customers reduce downtime, manage energy use, and improve operational efficiency. Modules feature real-time monitoring of Square D PowerPact with Micrologic circuit breakers, as well as a variety of other power distribution and monitoring devices. The solution collects data in real time and can send configurable email alerts to allow remote monitoring. The data can be used to pinpoint and immediately address troublesome areas and help facilitate a predictive maintenance program.

The modules consist of a 24 Vdc power supply with main power disconnect, communication device (IFM for Modbus Serial or both). For 600 V modules, a step-down transformer, and an additional Isolation module, mandatory to ensure data integrity on the ULP network is included. The accessory plate (see Figure MMS Communication Schematic Diagram) has available RJ45 ports for a certain number of circuit breakers to be communicated with as standard with room for expansion to additional breakers by adding parts in the field (see Catalog Number table below).

IFM module, Right
120-480 V

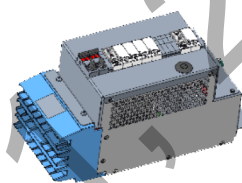

Catalog Number	Voltage Vac	Features	Number of circuit breakers unit will communication to as standard	Additional number of circuit breakers unit can communicate to with Field Kit* added	Total possible number of communicating circuit breakers per module
ICWL2222M01	120-240	For Mounting on Wide Side, when Wide side of I-Line panelboard is mounted on Left, IFM, Interface for Modbus-SL communications.	1	8	9
ICWR2222M01	120-240	For Mounting on Wide Side, when Wide side of I-Line panelboard is mounted on Right, IFM, Interface for Modbus-SL communications.	1	6	7
ICWL2422M01	277-480	For Mounting on Wide Side, when Wide side of I-Line panelboard is mounted on Left, IFM, Interface for Modbus-SL communications.	1	8	9
ICWR2422M01	277-480	For Mounting on Wide Side, when Wide side of I-Line panelboard is mounted on Right, IFM, Interface for Modbus-SL communications.	1	6	7
ICWL2622M01	600	For Mounting on Wide Side, when Wide side of I-Line panelboard is mounted on Left, IFM, Interface for Modbus-SL communications.	1	2	3
ICWR2622M01.	600	For Mounting on Wide Side, when Wide side of I-Line panelboard is mounted on Right, IFM, Interface for Modbus-SL communications.	1	2	3
ICNL2222M01	120-240	For Mounting on Narrow Side, when Narrow side of I-Line panelboard is mounted on Left, IFM, Interface for Modbus-SL communications.	1	3	4
ICNR2222M01.	120-240	For Mounting on Narrow Side, when Narrow side of I-Line panelboard is mounted on Right, IFM, Interface for Modbus-SL communications.	1	2	3

Catalog Number	Voltage Vac	Features	Number of circuit breakers unit will communication to as standard	Additional number of circuit breakers unit can communicate to with Field Kit* added	Total possible number of communicating circuit breakers per module
ICNL2422M01	277-480	For Mounting on Narrow Side, when Narrow side of I-Line panelboard is mounted on Left, IFM, Interface for Modbus-SL communications.	1	3	4
ICNR2422M01	277-480	For Mounting on Narrow Side, when Narrow side of I-Line panelboard is mounted on Right, IFM, Interface for Modbus-SL communications.	1	2	3

Coming Q1, 2024

***Kits for IFM Install**

(Refer to Instruction Bulletin JYT97577 for details regarding expanding the module using IFM Kits)

Part Number	Description
ICIFM1	IFM Kit (Qty 1)
ICIFM5	IFM Kit (Qty 5)

NOTES:

- Narrow Side units are not available for greater than 480 Vac.
- Maximum of 11 IFM interfaces can be physically connected to one UPaS Interface. This can be used for applications that have the lowest performance requirement and are recommended for simple applications.
- Maximum of eight UPaS interfaces should be used for applications that require regular access via the IFE web pages or that have other primaries communicating, such as FDM128 display. This normally provides a reasonable response time for up to three primaries.
- Each circuit breaker communications application will require an NSX Cord and BSCM communication module.
- H-/J-/L- frame breakers will require the suffix EH or EL.
- Each P-/R- frame circuit breaker to be used for communications will require the suffix E1.
- P-/R- Frame Circuit breakers require that the trip unit be powered externally when the breaker is in the "OFF" position. This may be accomplished by utilizing the external 24 Vdc power source provided by the IFM version of the Wide Side communicating versions of I-Line Enable module or a Narrow Side Power Supply Only version may be utilized. No other power source would be required. The U-PaS units do not include a 24 Vdc output.
- H-/J-/L- Frame circuit breakers are powered via the ULP Connections. No other external power supply sources are required for these breakers when utilizing any Communication I-Line Enable module version (Wide Side or Narrow Side).
- When adding IFMs to the I-Line Enable modules, count the number of communicating circuit breakers, "X+". For IFM I-Line Enable modules, catalog numbers ICW*2*22M01, the additional number of IFMs would be X-1. Refer to Instruction Bulletin, JYT97577 for additional components required for each additional IFM.
- For each additional IFM for 600 V systems it will require qty. 1 of 600 V Isolation Module and Comms Cord.

Multiple Communication Modules (IFM) can be connected to UPaS to provide a serial network of breakers to an Ethernet network as shown below, respecting limits noted above.

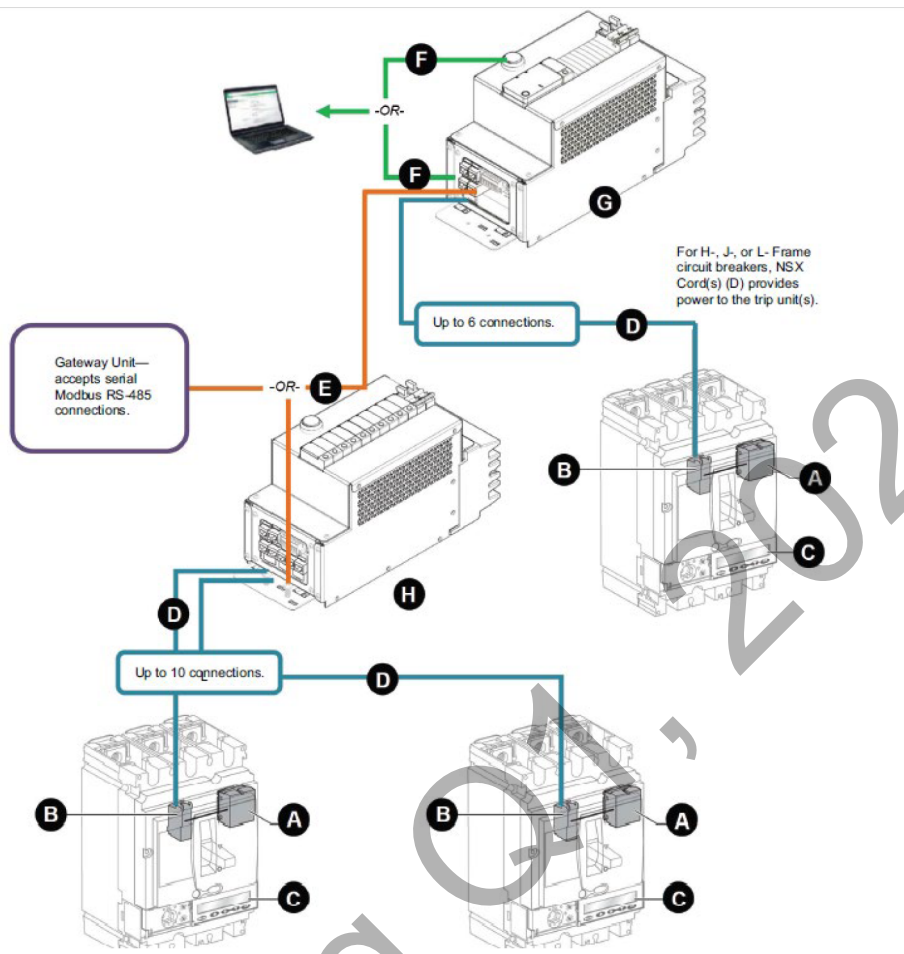

EcoStruxure Panel Server Module

EcoStruxure Panel Server is a gateway, providing connection of wired smart IoT devices to edge control software or cloud application. Connect most of Modbus/RS485 and Modbus/TCP devices from the market including Power Meters and Protection devices from Schneider Electric. User friendly web pages offer first-level of monitoring of measurements of all the connected devices including log of all alarms. Simple troubleshooting of the system through embedded web pages with advanced diagnostic information and logs. Easy commissioning through embedded web pages or with EcoStruxure Power Commission software that will offer commissioning reports and advanced features. Refer to Ecostruxure Panel Server Technical Leaflet (PLSED310196EN) for more information.

The modules consist of a 24 Vdc power supply with main power disconnect and Ethernet Gateway/Cloud Server (catalog # PAS600L) communication device. For 600 V modules, a step-down transformer is included. Two Ethernet ports are provided for networking: one for customer SCADA system and one for possible daisy-chaining of other I-Line Enable modules or Ethernet communicating equipment. In addition, a front bulkhead connector for computer software programming and access to the U-PaS panel server component.

Ecostruxure Panel Server I-Line Enable Module



Catalog Number	Voltage Vac	Features
ICWL222XUPAS	120–240	For Mounting on Wide Side, when Wide side of I-Line panelboard is mounted on Left, Universal Panel Server
ICWR222XUPAS	120–240	For Mounting on Wide Side, when Wide side of I-Line panelboard is mounted on Right, Universal Panel Server
ICWL242XUPAS	277–480	For Mounting on Wide Side, when Wide side of I-Line panelboard is mounted on Left, Universal Panel Server
ICWR242XUPAS	277–480	For Mounting on Wide Side, when Wide side of I-Line panelboard is mounted on Right, Universal Panel Server
ICWL262XUPAS	600	For Mounting on Wide Side, when Wide side of I-Line panelboard is mounted on Left, Universal Panel Server
ICWR262XUPAS	600	For Mounting on Wide Side, when Wide side of I-Line panelboard is mounted on Right, Universal Panel Server
ICNL222XUPAS	120–240	For Mounting on Narrow Side, when Narrow side of I-Line panelboard is mounted on Left, Universal Panel Server
ICNR222XUPAS	120–240	For Mounting on Narrow Side, when Narrow side of I-Line panelboard is mounted on Right, Universal Panel Server
ICNL242XUPAS	277–480	For Mounting on Narrow Side, when Narrow side of I-Line panelboard is mounted on Left, Universal Panel Server
ICNR242XUPAS	277–480	For Mounting on Narrow Side, when Narrow side of I-Line panelboard is mounted on Right, Universal Panel Server

NOTES:

- Connect U-PaS to either a Modbus communicating device or a Communicating I-Line Enable module (IFM Only Version) via RS-485 port (2-wire Modbus). See diagram below.
- U-PaS I-Line Enable module can be connected to either an Ethernet communicating device or an Ethernet network via the dual Ethernet ports, ETHER 1 or ETHER 2. See diagram below. Daisy-chaining of multiple Ecostruxure Panel Server I-Line Enable modules is also possible via the dual Ethernet ports.
- Ecostruxure Panel Server I-Line Enable modules do not have space to add IFM devices nor do they have a 24 Vdc output. It is intended to connect to downstream IFM I-Line Enable modules.
- Two digital outputs (dry contact type) are standard and can be re-configured via Ecostruxure Power Commission (EPC) software as pulse type inputs, used to count pulses delivered by as WAGES (Water, Air, Gas, Electricity, Steam) metering device.

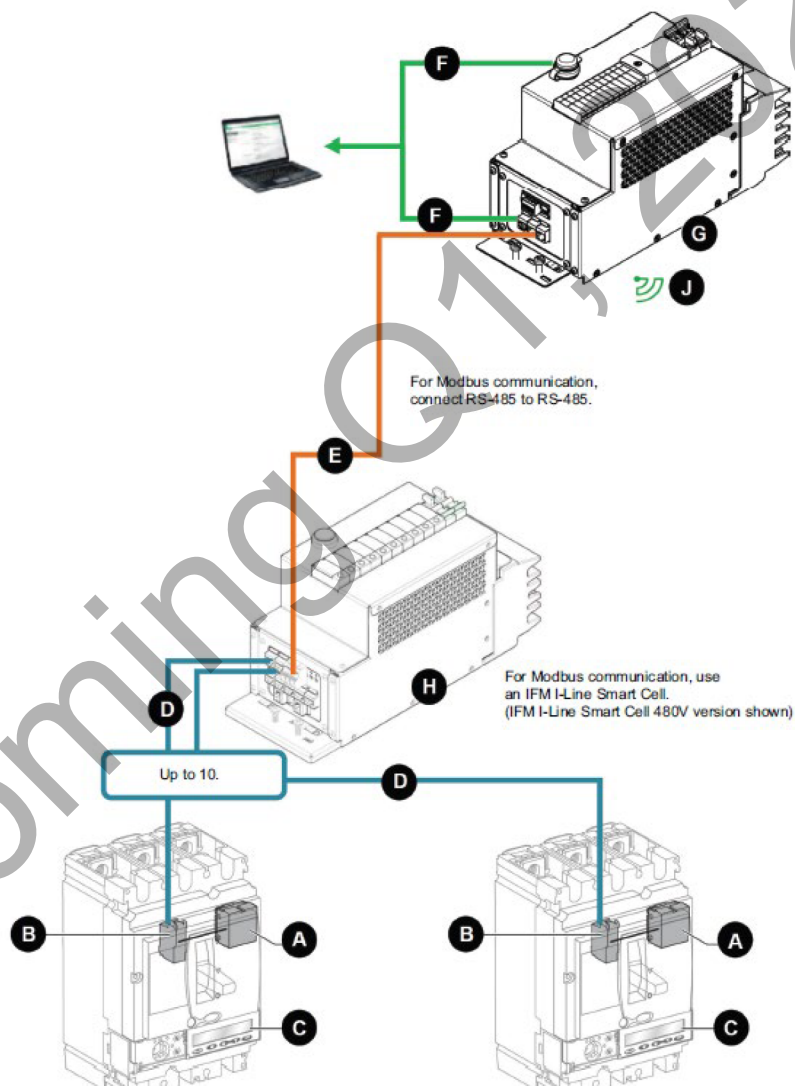

Metering Modules

I-Line Enable Metering modules are available for various voltage systems. Below is a chart for which meter packages are available for the various voltage configurations offered.

Applicable Voltage System	Metering System Available	
	PM5563	PM8244
208Y/120 3P4W	X	X
480Y/277 3P4W	X	X*
240/120 3P4W	X	X
240 3P3W	X	X
240 3P3W GND B	—	—
480 3P3W	X	—
480 3P3W GND B	—	—
600 3P3W	—	—
600Y/347 3P4W	X*	X*
120/240 1P3W	X*	X*
480Y/227 1P3W	X*	X*
240 1P2W	X*	X*
600 1P2W	X*	X*
220Y/110 3P4W	X	X
230Y/115 3P4W	X	X
380Y/220 3P4W	X	X
415Y/240 3P4W	X	X
110/220 1P3W	X*	X*
115/230 1P3W	X*	X*
127/220 1P3W	X*	X*

*Requires Neutral Connection to I-Line Enable module

Power Meters

PM5563 is a basic, multi-function meter with a backlit LCD remote display. The meter provides Class 0.2S accuracy per IEC 62053-22 standard and 128 samples per cycle. The meter will measure Energy, Active and Reactive Power, Voltage, Current, Frequency, Power Factor and up to the 63rd Harmonic. Include 1.1 Megabytes of memory for up to 14 selectable parameters with configurable interval and duration. Communication protocols are Modbus RTU and ASCII two wires with RS485 port support plus Modbus TCP/IP, Ethernet/IP and BACnet/IP based on 10/100 Mbit/s, daisy chain Ethernet with RJ45 port support. The embedded communication capabilities allow the support of the DNP 3.0 protocol, the access to an onboard web server. The meter also has four digital inputs with WAGES support and two digital outputs.

These modules contain a 3-pole main fused disconnect to remove power from the inside of the unit while installed on the I-Line bus stack, meter device, CT (Split Core Current Transformer) connection terminals, front local Ethernet bulkhead connector for meter programming, two Ethernet ports networking: one for customer SCADA system and one for possible daisy-chaining of other I-Line Enable modules or Ethernet communicating equipment, two digital inputs and two digital outputs for customer alarms.

Power Meter Series I-Line Enable Module

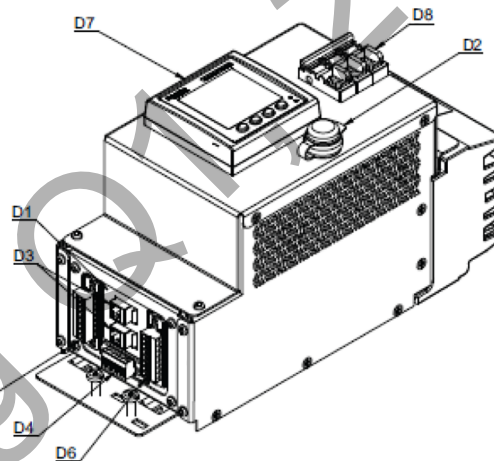

Table 2 - Power Meter 5563 Series Catalog Numbers

Catalog Number	Voltage Vac	Features
ICWL243X5563	120–480	For Mounting on Wide Side, when Wide side of I-Line panelboard is mounted on Left, PM5563 meter
ICWR243X5563	120–480	For Mounting on Wide Side, when Wide side of I-Line panelboard is mounted on Right, PM5563 meter
ICWL263X5563	600	For Mounting on Wide Side, when Wide side of I-Line panelboard is mounted on Left, PM5563 meter
ICWR263X5563	600	For Mounting on Wide Side, when Wide side of I-Line panelboard is mounted on Right, PM5563 meter

NOTES:

- Power Meter 5563 series I-Line Enable modules require a set of iron core current transducers (CTs) be installed by the customer or factory installed on fully assembled I-Line panelboards. Select transducer kits from the following list based on the specific amperage rating:

100 A	3090SCCT022
150 A	3090SCCT032
250 A	3090SCCT043
400 A	3090SCCT063
600 A	3090SCCT083
800 A	3090SCCT084
1200 A	3090SCCT124

- Power Meter 5563 Series I-Line Enable modules include a Shorting Block Kit to be installed prior to installing the module in the panelboard according to the instructions packaged with the kit.
- See PowerLogic Catalog (PLSED309005EN) for more information.

The Power Meter 5563 Series I-Line Enable module can be connected to a Communications I-Line Enable module with UPaS gateway, by connecting the RS-485 2-wire Modbus connection. It is also possible to daisy chain the Power Meter I-line Enable module Cell via Ethernet connections. See diagram below.

Power Meter Series Communication Schematic Diagram

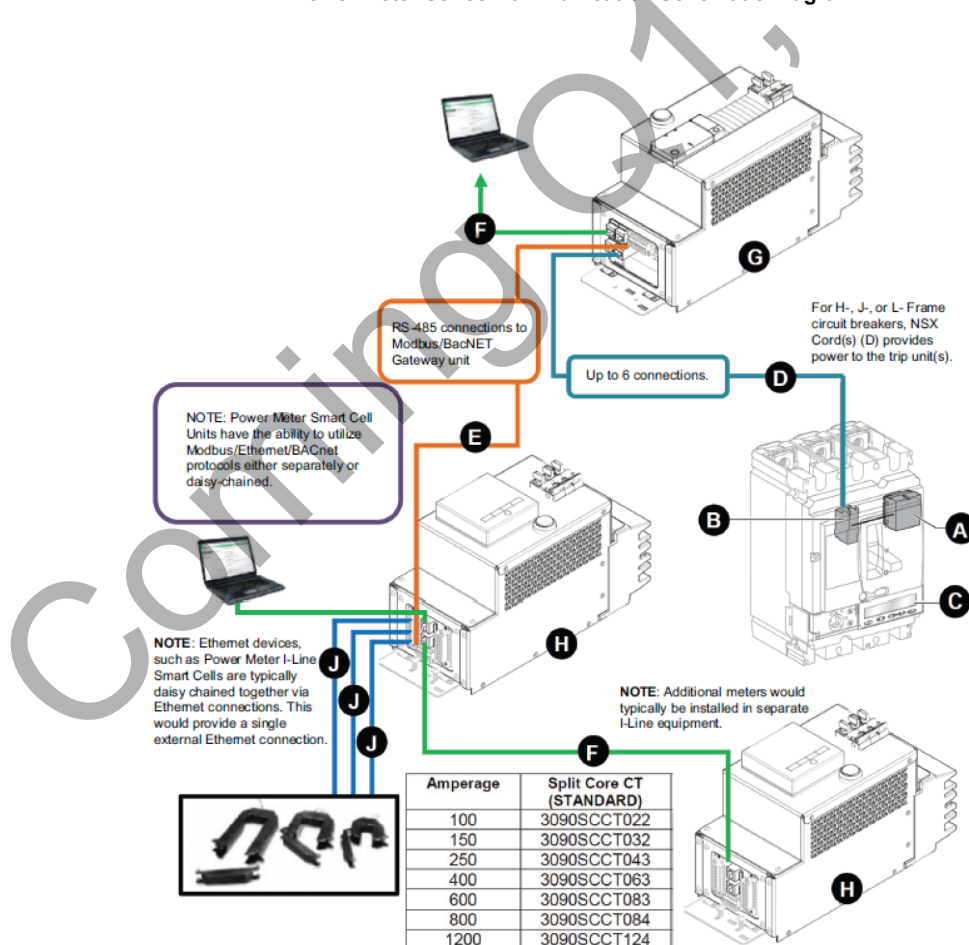

PowerLogic PM8244 meters are compact, cost-effective multifunction advanced power quality meters that will help you ensure reliability and efficiency of your power-critical facility. They reveal and provide understanding of complex power quality conditions enabling action to be taken to mitigate issues. With patented Disturbance Direction Detection, revenue grade accuracy, multiple communication ports, onboard power quality analysis, web interface and a color graphical display.

These modules contain a 3-pole main fused disconnect to remove power from the inside of the unit while installed on the I-Line bus stack, meter device, CT (Split Core Current Transformer) connection terminals, front local Ethernet bulkhead connector for meter programming, 2 Ethernet ports networking: 1 for customer SCADA system and 1 for possible daisy-chaining of other I-Line Enable modules or Ethernet communicating equipment, 2 digital inputs & 2 digital outputs for customer alarms.

Power Meter Series I-Line Enable Module

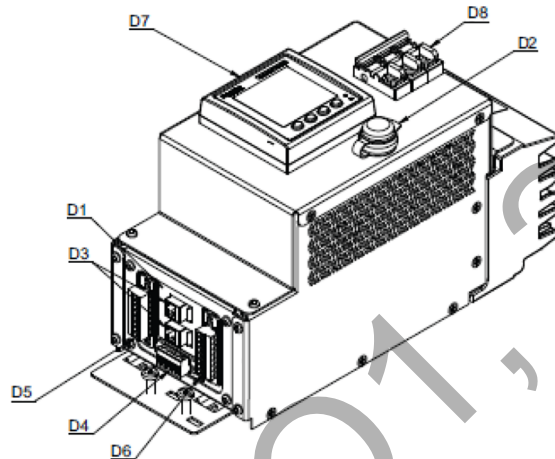

Table 3 - Power Meter 8244 Series Catalog Numbers

Catalog Number	Voltage Vac	Features
ICWL243X8244	120–480	For Mounting on Wide Side, when Wide side of I-Line panelboard is mounted on Left, PM8244 meter
ICWR243X8244	120–480	For Mounting on Wide Side, when Wide side of I-Line panelboard is mounted on Right, PM8244 meter
ICWL263X8244	600	For Mounting on Wide Side, when Wide side of I-Line panelboard is mounted on Left, PM8244 meter
ICWR263X8244	600	For Mounting on Wide Side, when Wide side of I-Line panelboard is mounted on Right, PM8244 meter

NOTES:

- Power Meter 8244 series I-Line Enable modules require a set of iron core current transducers (CTs) be installed by the customer or factory installed on fully assembled I-Line panelboards. Select transducer kits from the following list based on the specific amperage rating:

100 A	3090SCCT022
150 A	3090SCCT032
250 A	3090SCCT043
400 A	3090SCCT063
600 A	3090SCCT083
800 A	3090SCCT084
1200 A	3090SCCT124

- Power Meter 8244 Series I-Line Enable modules include a Shorting Block Kit to be installed prior to installing the module in the panelboard according to the instructions packaged with the kit.
- See PowerLogic Catalog (PLSED309005EN) for more information.

The Power Meter 8244 Series I-Line Enable module can be connected to a Communications I-Line Enable module with UPaS gateway, by connecting the RS-485 2-wire Modbus connection. It is also possible to daisy chain the Power Meter I-line Enable module Cell via Ethernet connections. See diagram below.

Power Meter Series Communication Schematic Diagram

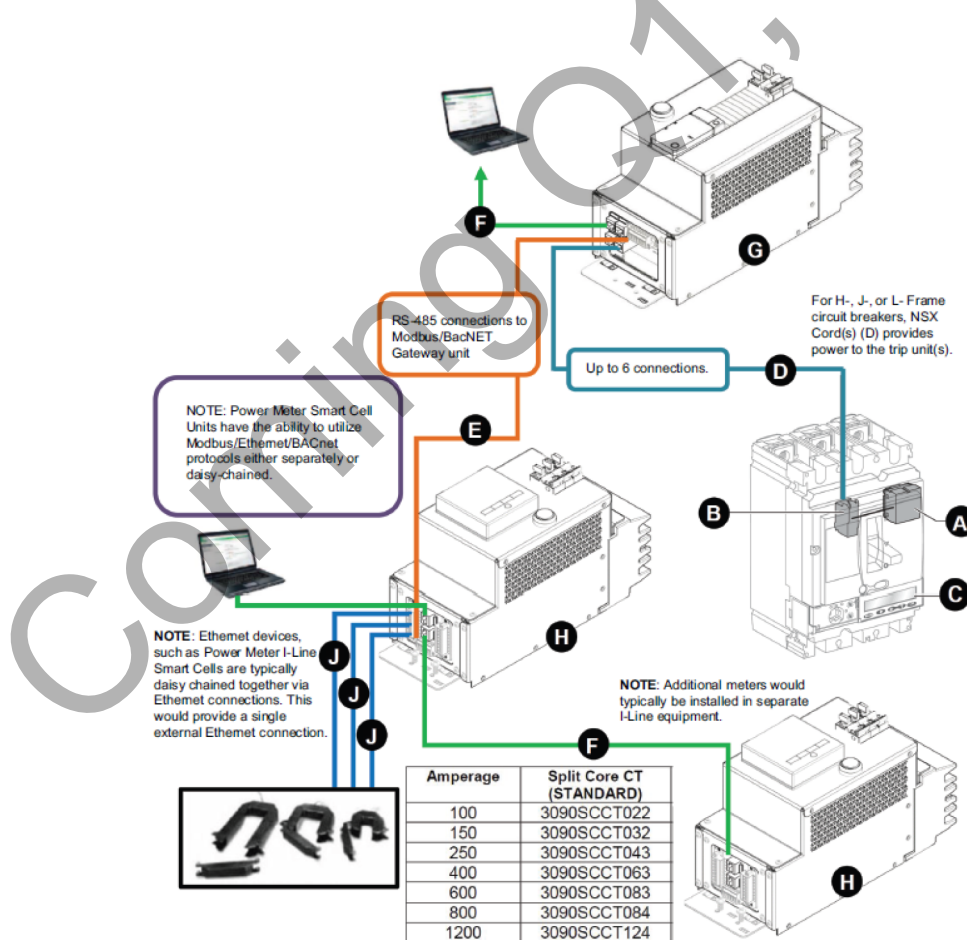

I-Line Enable modules provided with Power Meter 5563 or 8244 require different numbers of CTs based on the Voltage and Wiring configurations. Refer to the chart below for the number of CTs required.

Applicable Voltage System	Qty of CTs Required (minimum)
208Y/120 3P4W	4
480Y/277 3P4W	4
240/120 3P4W	4
240 3P3W	3
240 3P3W GND B	3
480 3P3W	3
480 3P3W GND B	3
600 3P3W	3
600Y/347 3P4W	4
120/240 1P3W	2
480Y/227 1P3W	2
240 1P2W	1
600 1P2W	1
220Y/110 3P4W	4
230Y/115 3P4W	4
380Y/220 3P4W	4
415Y/240 3P4W	4
110/220 1P3W	2
115/230 1P3W	2
127/220 1P3W	2

Dimensions for Standard NEMA Type 1 Enclosures

Type HCJ—800 A Maximum Main Lugs

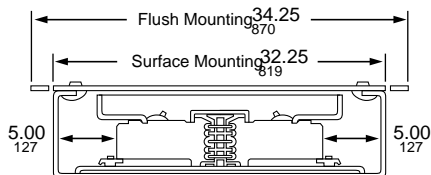
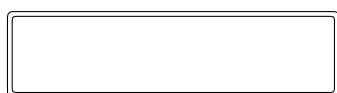
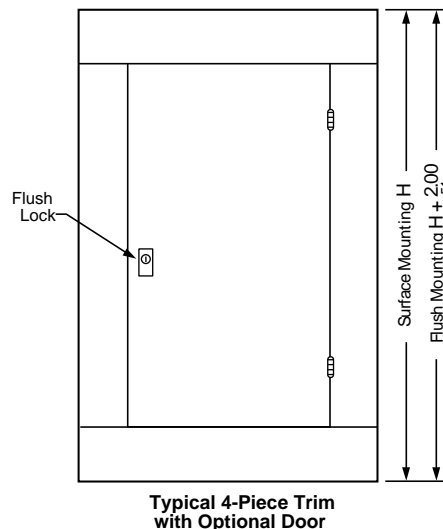
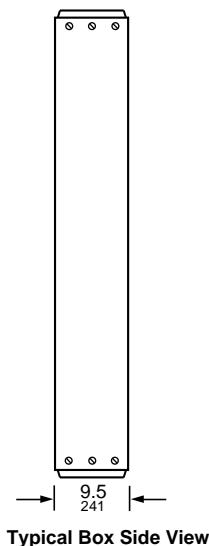
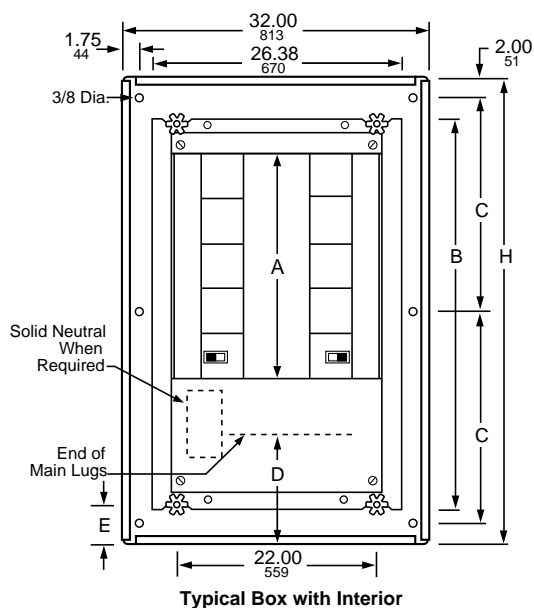

Typical Mounting of BD, BG, BJ, BK, HD, HG, HJ, HL, HR, JD, JG, JJ, JL, JR, QB, QD, QG, QJ Circuit Breakers

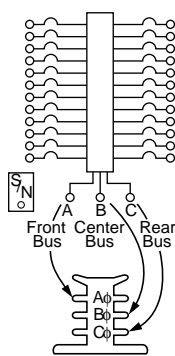

Typical Wiring Diagram
Branch connection phasing is determined by circuit breaker selection.

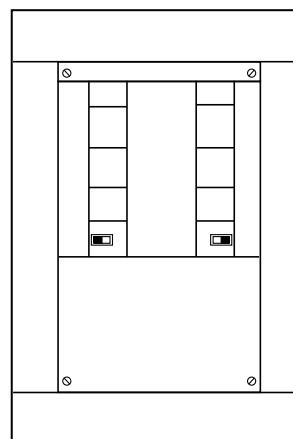

Main Lugs Ampere Rating	H		A		B		C		D		E	
	in.	mm	in.	mm	in.	mm	in.	mm	in.	mm	in.	mm
400–800	48	1219	13.5	343	30	762	21.85	555	14.9	378	9.3	236
	73	1854	31.5	800	48	1219	22.9	582	18.4	467	12.8	325
	91	2311	49.5	1257	66	1676	28.9	734	18.4	467	12.8	325

H = Box height for surface mount panel

A = Circuit breaker mounting space (x2 for double row)

B = Total height of interior

C = Height between box mounting holes center to center

D = Distance between end of panel and end of main lugs or main circuit breaker lugs

E = Distance between end of panel and interior mounting studs.

Type HCJ 400 A Maximum Main Circuit Breaker

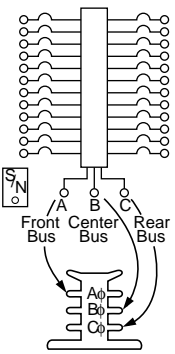
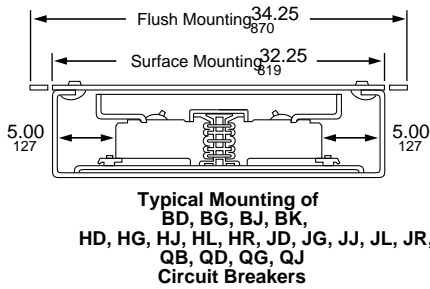
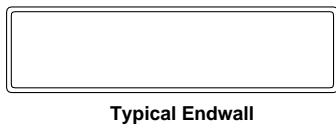
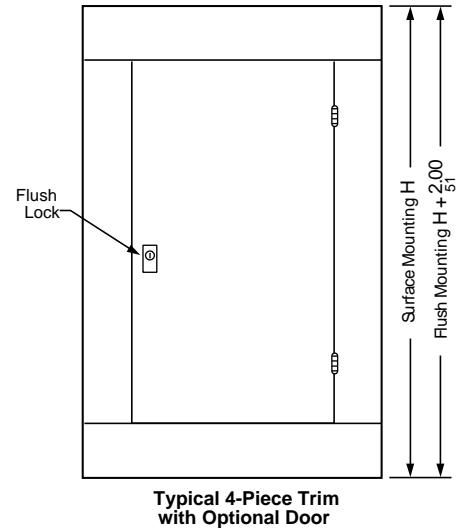
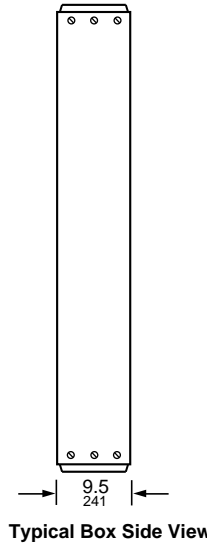
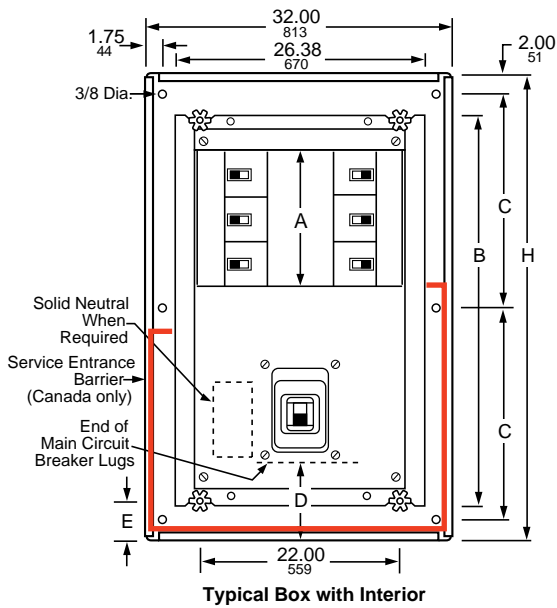

Branch connection phasing is determined by circuit breaker selection.

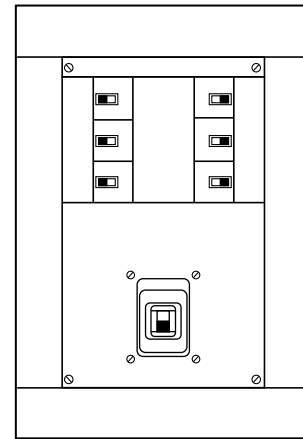

Main Circuit Breaker Ampere Rating	H		A		B		C		D		E	
	in.	mm	in.	mm	in.	mm	in.	mm	in.	mm	in.	mm
400	64	1626	13.5	343	48	1219	22.9	582	16.96	431	12.8	325
	73	1854	22.5	572	48	1219	22.9	582	16.96	431	12.8	325
	91	2311	40.5	1029	66	1676	28.9	734	16.96	431	12.8	325

- H = Box height for surface mount panel
- A = Circuit breaker mounting space (x2 for double row)
- B = Total height of interior
- C = Height between box mounting holes center to center
- D = Distance between end of panel and end of main lugs or main circuit breaker lugs
- E = Distance between end of panel and interior mounting studs.

Type HCJ—800 A Maximum Main Circuit Breaker

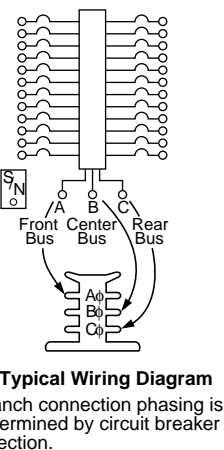
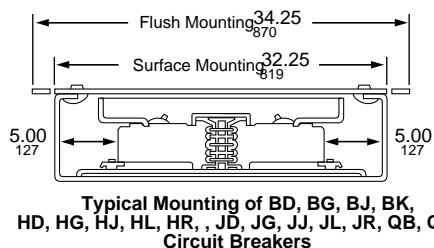
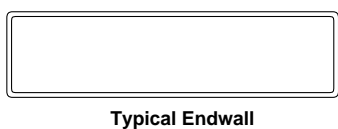
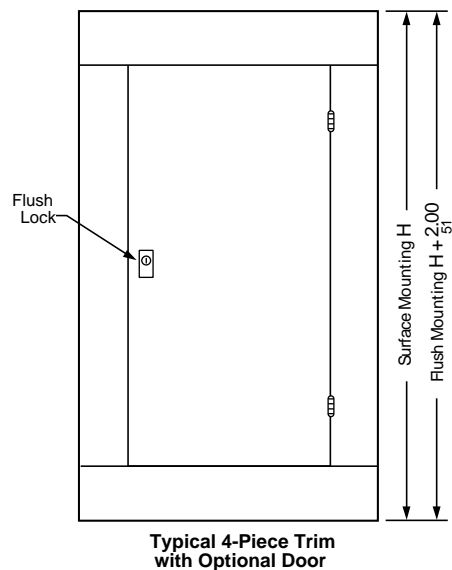
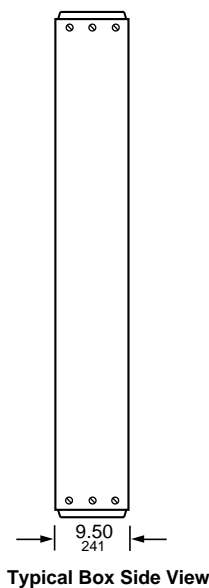
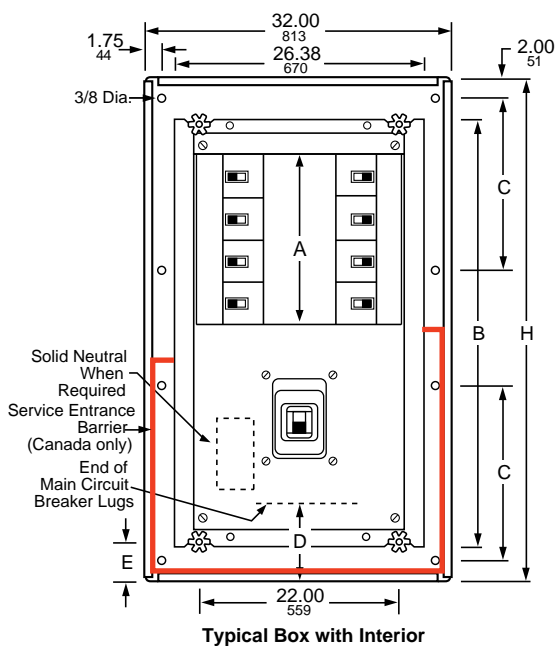

Branch connection phasing is determined by circuit breaker selection.

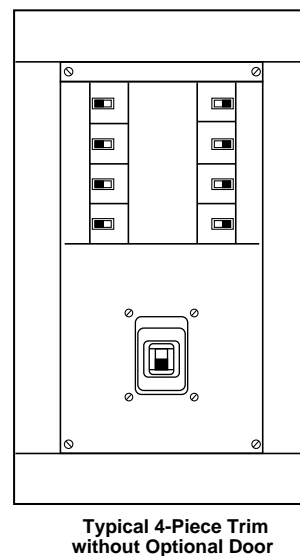

Main Circuit Breaker Ampere Rating	H		A		B		C		D		E	
	in.	mm	in.	mm	in.	mm	in.	mm	in.	mm	in.	mm
600–800	73	1854	18	457	48	1219	22.9	582	18.68	474	12.8	325
	91	2311	36	914	66	1676	28.9	734	18.68	474	12.8	325

H = Box height for surface mount panel

A = Circuit breaker mounting space (x2 for double row)

B = Total height of interior

C = Height between box mounting holes center to center

D = Distance between end of panel and end of main lugs or main circuit breaker lugs

E = Distance between end of panel and interior mounting studs.

Type HCP—800 A Maximum Main Lugs

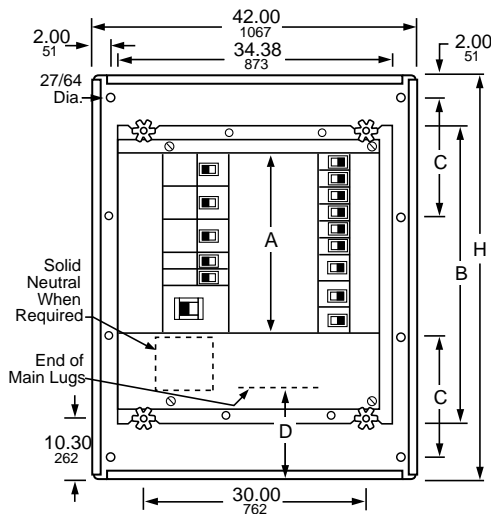

Typical Box with Interior

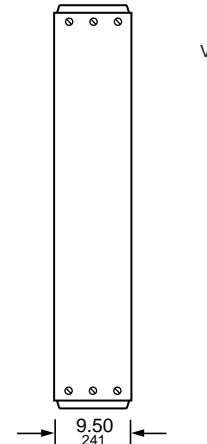

Typical Box Side View

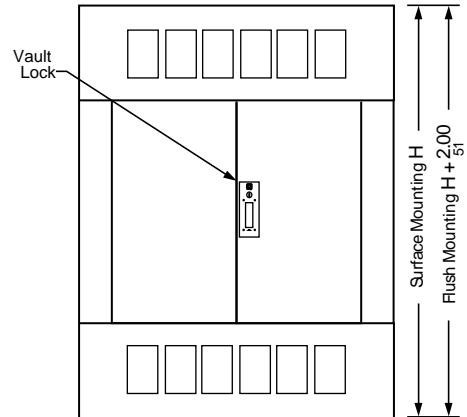

Typical 4-Piece Trim with Optional Door

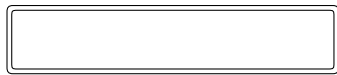

Typical Endwall

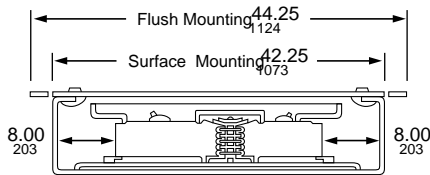

Typical Mounting of BD, BG, BJ, BK, HD, HG, HJ, HL, JD, JG, JJ, JL, LA, LJ, LL, LR, MG, MJ, PG, PJ, PK, PL, QB, QD, QG, QJ Circuit Breakers

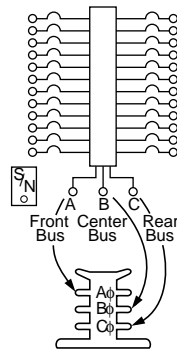

Typical Wiring Diagram
Branch connection phasing is determined by circuit breaker selection.

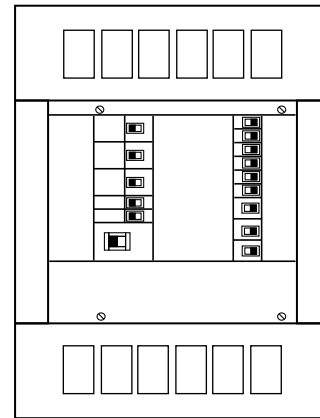

Typical 4-Piece Trim without Optional Door

Main Lugs Ampere Rating	H		A		B		C		D	
	in.	mm	in.	mm	in.	mm	in.	mm	in.	mm
400-800	50	1270	13.5	343	30	762	22.85	580	17.5 ¹⁴	445 ¹⁴
	59	1499	22.5	572	39	991	27.35	695	17.5 ¹⁴	445 ¹⁴
	68	1727	31.5	800	48	1219	31.85	809	17.5 ¹⁴	445 ¹⁴
	86	2184	49.5	1257	66	1676	27.23	692	17.5 ¹⁴	445 ¹⁴

H = Box height for surface mount panel

A = Circuit breaker mounting space (x2 for double row)

B = Total height of interior

C = Height between box mounting holes center to center

D = Distance between end of panel and end of main lugs or main circuit breaker lugs

E = Distance between end of panel and interior mounting studs.

14. For 800 A dimension D = 16.32 in, or 415 mm)

Type HCP—1200 A Maximum Main Lugs

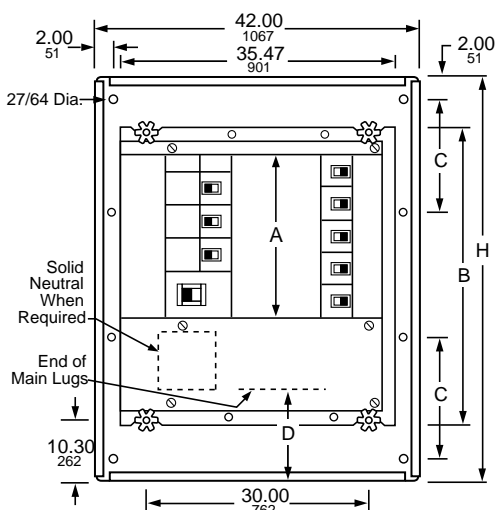

Typical Box with Interior

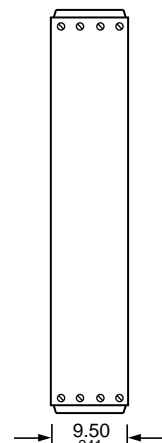

Typical Box Side View

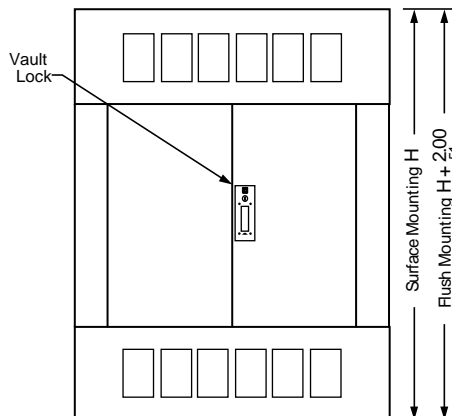

Typical 4-Piece Trim with Optional Door

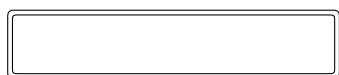

Typical Endwall

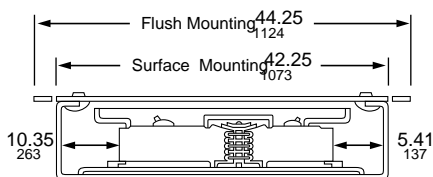

Typical Mounting of
BD, BG, BJ, BK,
HD, HG, HJ, HL, JD, JG, JJ, JL,
LA, LD, LJ, LL, LR,
MG, MJ, PG, PJ, PK, PL, QB, QD, QG, QJ
Circuit Breakers

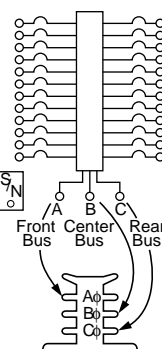

Typical Wiring Diagram
Branch connection phasing is determined by circuit breaker selection.

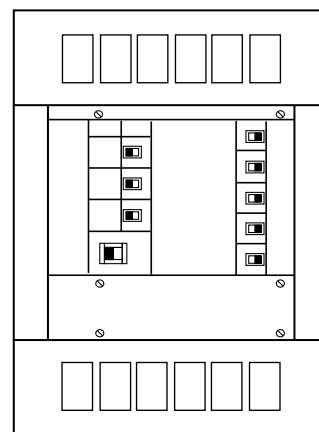

Typical 4-Piece Trim without Optional Door

Main Lugs Ampere Rating	H		A		B		C		D	
	in.	mm	in.	mm	in.	mm	in.	mm	in.	mm
1200	50	1270	13.5	343	30	762	22.85	580	16.32	415
	59	1499	22.5	572	39	991	27.35	695	17.5	445
	68	1727	31.5	800	48	1219	31.85	809	17.5	445
	86	2184	49.5	1257	66	1676	27.23	692	17.5	445

H = Box height for surface mount panel

A = Circuit breaker mounting space (x2 for double row)

B = Total height of interior

C = Height between box mounting holes center to center

D = Distance between end of panel and end of main lugs or main circuit breaker lugs

E = Distance between end of panel and interior mounting studs.

Type HCP—800 A Maximum Main Circuit Breaker

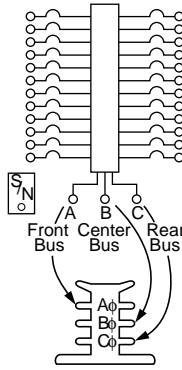
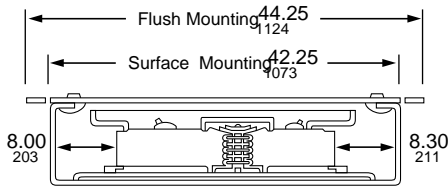
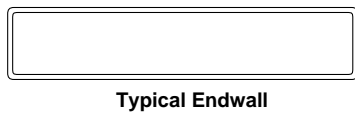
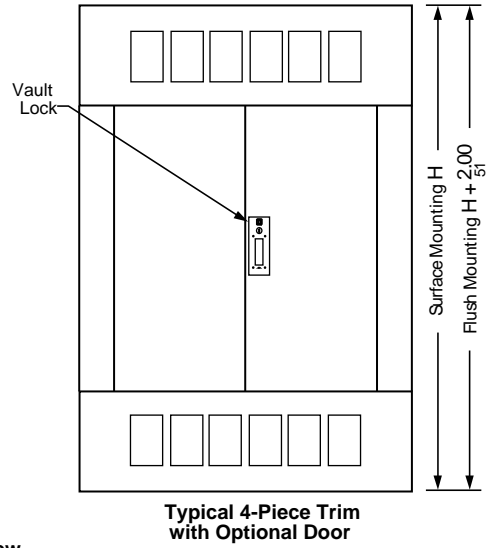
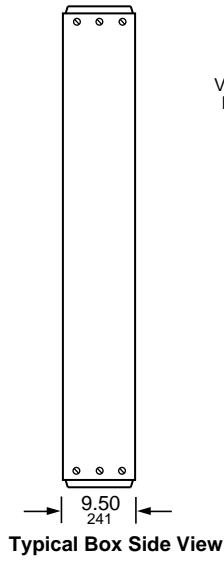
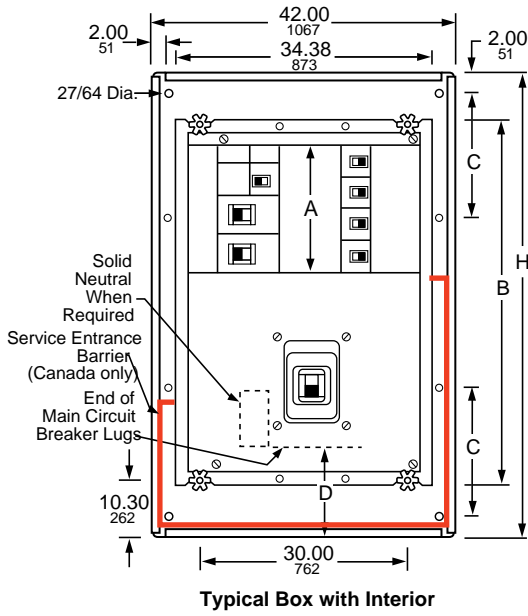

Branch connection phasing is determined by circuit breaker selection.

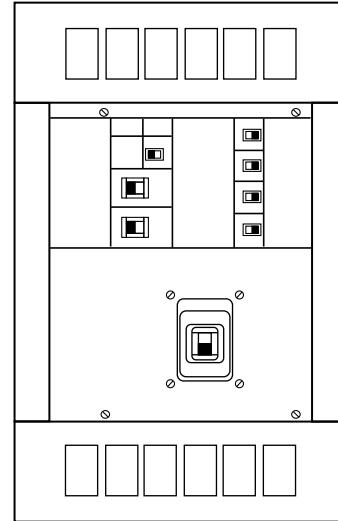

Main Circuit Breaker Ampere Rating	H		A		B		C		D	
	in.	mm	in.	mm	in.	mm	in.	mm	in.	mm
600–800	68	1727	18	457	48	1219	31.85	809	18.68	474
	86	2184	36	914	66	1676	27.23	692	18.68	474

H = Box height for surface mount panel

A = Circuit breaker mounting space (x2 for double row)

B = Total height of interior

C = Height between box mounting holes center to center

D = Distance between end of panel and end of main lugs or main circuit breaker lugs

E = Distance between end of panel and interior mounting studs.

Type HCP-SU—800 A Maximum Main Circuit Breaker

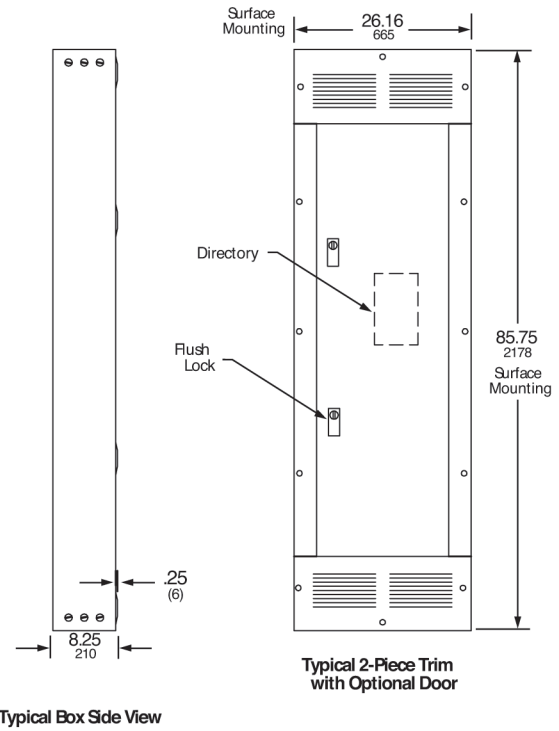
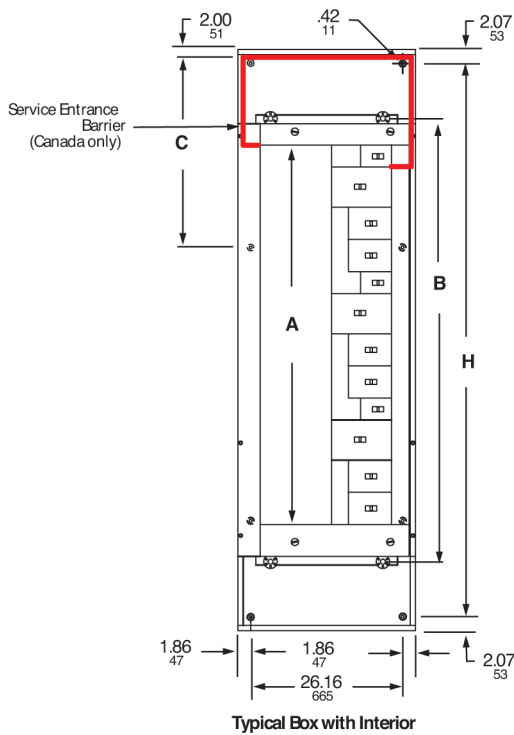

Typical Mounting of BD, BG, BJ, BK, HD, HG, HJ, HL, JD, JG, JJ, JL, LA, LG, LJ, LL, LR, MG, MJ, PG, PJ, PK, PL, QB, QD, QG, QJ Circuit Breakers

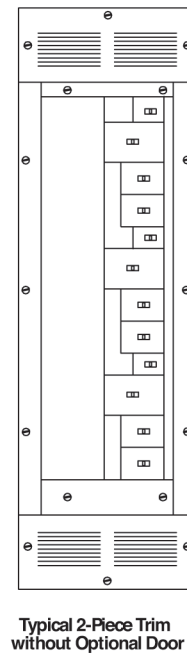
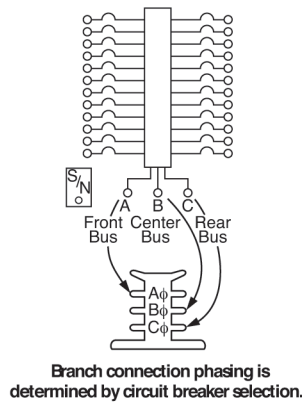

Main Circuit Breaker Ampere Rating	H		A		B		C	
	in.	mm	in.	mm	in.	mm	in.	mm
800	86	2184	54	1372	65.4	1661	27.23	692

- H = Box height for surface mount panel
- A = Circuit breaker mounting space
- B = Total height of interior
- C = Height between box mounting holes center to center

Type HCR-U—1200 A Main Lugs or Main Circuit Breaker

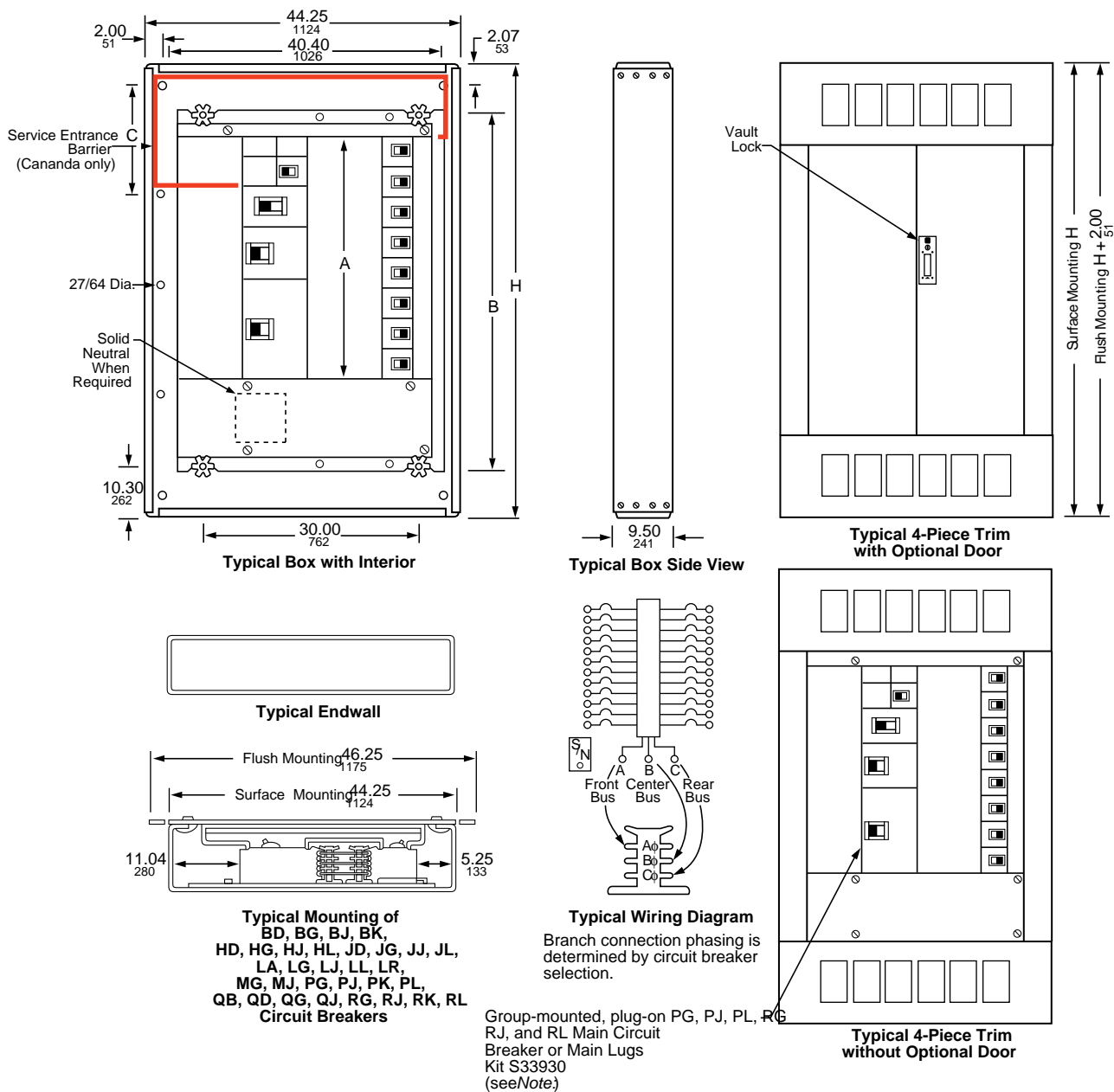

Main Lugs or Main Circuit Breaker Ampere Rating	H		A		B		C	
	in.	mm	in.	mm	in.	mm	in.	mm
1200	86	2184	54	1372	65.1	1654	18	457

H = Box height for surface mount panel

A = Circuit breaker mounting space

B = Total height of interior

C = Height between box mounting holes center to center

I-Line Panelboard Estimated Weights

I-Line MLO Panelboard—Type 1

Ampere Rating	I-Line Interior	Total Circuit Breaker Mounting Height	Interior Weight ¹⁵	Box Weight	4 Piece Trim Weight	Neutral	Ground Bar	Total PB less C/B's
800A	HCJ	27	94	78	22	5	1	200
		45	115	99	27			247
		63	140	111	32			289
		99	190	135	37			368
800A	HCP-SU	54	180	140	32	9		362
1200A	HCP	27	140	104	39	10		294
		45	175	121	39			346
		63	206	136	41			394
		99	268	167	45			491
1200A	HCR-U	108	215	185	49	10		460

I-Line MLO Panelboard—Type 1 with door

Ampere Rating	I-Line Interior	Total Circuit Breaker Mounting Height	Interior Weight ¹⁵	Box Weight	Trim with door weight	Neutral	Ground Bar	Total PB less C/B's
800A	HCJ	27	94	78	45	5	1	223
		45	115	99	59			279
		63	140	111	67			324
		99	190	135	83			414
800A	HCP-SU	54	180	140	92	9		422
1200A	HCP	27	140	104	68	10		323
		45	175	121	78			385
		63	206	136	92			445
		99	268	167	108			554
1200A	HCR-U	108	215	185	110	10		521

I-Line MLO Panelboard—Type 3R

Ampere Rating	I-Line Interior	Total Circuit Breaker Mounting Height	Interior Weight ¹⁵	Type 3R Box & Trim Weight	Neutral	Ground Bar	Total PB less C/B's
800A	HCJ	27	94	250	5	1	350
		45	115	268			389
		63	140	278			424
		99	190	338			534
800A	HCP-SU	54	180	352	9		542
1200A	HCP	27	140	270	10		421
		45	175	305			491
		63	206	340			557

15. All of the interior weights include copper bus.

		99	268	419		698
1200A	HCR-U	108	215	492	10	718

	Weight
Copper neutral	2
100 A Sub Feed Lugs	5
250 A Sub Feed Lugs	6
400 A Sub Feed Lugs	10
800 A Sub Feed Lugs	17
1200 A Sub Feed Lugs, 9"	28
1200 A Sub Feed Lugs, 15"	42
I-Line SPD	23

NOTE: For all panelboards, add all circuit breaker weights from circuit breaker catalog. For Main Circuit Breaker panelboards, use MLO Panelboard weight and add main breaker weight from circuit breaker catalog.

Appendix—Merchandise Unit Catalog Numbers

Table 4 - Interiors, Boxes and Fronts

Total Circuit Breaker Mounting Space (In.)	Mains Ampere Rating	Interior Assembly (Less Branch Circuit Breakers)	Front ¹⁶		Box ¹⁷		Box Height (In.)
			4 Piece Trim Without Door	Trim With Door ¹⁷	Type 1	NEMA 3R/5/12 ¹⁸ (Includes Front)	
			Catalog Number	Catalog Number	Catalog Number	Catalog Number	
HCJ Main Lugs Only 3-pole—Suitable for use as service equipment when provided with a main circuit breaker and service barrier kit.							
27	400 A	HCJ14484	HCM48T()	HCM48T()D	HC3248DB9	HCJ3248WP	48
		HCJ14484CU					
	600 A	HCJ14486					
		HCJ14486CU					
800 A	HCJ14488						
45	400 A	HCJ23734	HCM73T()	HCM73T()D	HC3273DB9	HCJ3273WP	73
	600 A	HCJ23736					
	800 A	HCJ23738					
63	400 A	HCJ32734	HCM91T()	HCM91T()D	HC3291DB9	HCJ3291WP	91
		HCJ32734CU					
	600 A	HCJ32736					
		HCJ32736CU					
800 A	HCJ32738						
99	400 A	HCJ50914	HCM91T()	HCM91T()D	HC3291DB9	HCJ3291WP	91
	600 A	HCJ50916					
	800 A	HCJ50918					
HCJ Main Circuit Breaker ¹⁹, Includes 3-pole, vertically mounted main circuit breaker							
27	400 A	HCJ14734M	HCM73T()	HCM73T()D	HC3273DB9	HCJ3273WP	73
36	600 A	HCJ18736MP					
	800 A	HCJ18738MP					
45	400 A	HCJ23734M	HCM91T()	HCM91T()D	HC3291DB9	HCJ3291WP	91
72	600 A	HCJ36916MP					
81	400 A	HCJ41914MCU					
		HCJ41914M					
	800 A	HCJ36918MP					
HCP-SU ²⁰ Universal Single Row Main Lugs or Main Circuit Breaker 3-pole—Suitable for use as service equipment when provided with a main circuit breaker and service barrier kit. For main circuit breaker panel, order plug-on I-Line type PG, PJ, PL, MG, or MJ circuit breakers from through and backfeed as the main breaker (order solid neutral from).							
54	800	HCP54868SU	HC2686T()4P	HC2686T()HR ²¹	HC2686DB	HC2886WP	86

16. Add "F" for flush mount, "S" for surface mount.

17. For Type 1 applications, order interior, front, and box. For Type 3R/5/12 applications, order interior and box only. The front is included with the box.

18. Remove drain screws for Type 3R rating.

19. Bottom feed standard.

20. For main lugs panel, order sub-feed lug kit and back-feed as main lugs.

21. Hinged trim with door.

Table 5 - (1200 A Interiors Include solid neutral, all others without solid neutral) ²²

Total Circuit Breaker Mtg. Space (In.)	Mains Amp. Rating	Max. No. of MJ, PL, RL Circuit Breakers	Interior Assembly (Less Branch Circuit Breakers) Catalog Number	Front ²³		Box ²⁴ Catalog Number	Box Height (In.)
				4 Piece Trim Without Door ²⁵	Trim With Door		
HCP Main Lugs Only—3-pole							
Suitable for use as service equipment when provided with a main circuit breaker and service barrier kit.							
27	400	1PL	HCP14504	HCW50T()	HCW50T()D	HC4250D-B	50
	600		HCP14506				
	800		HCP14508				
	1200		HCP145012N				
45	400	2PL	HCP23594	HCW59T()	HCW59T()D	HC4259D-B	59
	600		HCP23596				
	800		HCP23598				
	1200		HCP235912N				
63	400	3PL	HCP32684	HCW68T()	HCW68T()D	HC4268D-B	68
	600		HCP32686				
	800		HCP32688				
	1200		HCP326812N				
99	400	5PL	HCP50864	HCW86T()	HCW86T()D	HC4286D-B	86
	600		HCP50866				
	800		HCP50868				
	1200		HCP508612N				
HCP Main Circuit Breaker—Includes 3-pole							
Vertically mounted main circuit breaker							
36	600	2LC	HCP18686M	HCW68T()	HCW68T()D	HC4268D-B	68
	800		HCP18688M				
72	600	4LC	HCP36866M	HCW86T()	HCW86T()D	HC4286D-B	86
	800		HCP36868M				
HCR-U Universal Main Lugs or Main Circuit Breaker²⁶—3-pole							
Suitable for use as service equipment when provided with a main circuit breaker and service barrier kit.							
For Main Lugs panel, order sub-feed lug kit catalog number S33930 and back feed as main lugs.							
For Main Circuit Breaker panel, order plug-on I-Line type PG, PJ, PL, RGC, RJC, or RLC ²⁷ circuit breakers from and , and back feed as the main circuit breaker. (Order solid neutral separately)							
108 ²⁸	1200	6PL or 3RLC	HCR548612U	HCR86T() ²⁹	HCR86T()D	HC4486D-B	86

22. Order solid neutral separately for 800 A and below.

23. Add "F" for flush mount, "S" for surface mount.

24. For 42 in. wide weatherproof enclosures, replace "DB" suffix with "WP" Type 3R/5/12 Enclosures

25. Add-on door kit available. Example: For HCW50TS trim kit, order HCW50D door kit.

26. When RL main circuit breakers with equipment ground fault are applied on a 3Ø4W system, order solid neutral catalog number HCR12SNCT. The HCR12SNCT includes a neutral current transformer.

27. When RL main circuit breakers with equipment ground fault are applied on a 3Ø4W system, order solid neutral catalog number HCR12SNCT.

The HCR12SNCT includes a neutral current transformer.

28. 15 in. of mounting space is taken up by the back fed main lug kit or RG, RJ, RL main circuit breaker, leaving 93 in. of branch circuit breaker mounting space.

29. Add-on door kit available. Example: For HCR86TS trim kit, order HCW86D door kit.

Glossary

C

Circuit Breaker Communication Module (BSM or BSCM):

A module which, when installed in a circuit breaker, receives and transmits information on the communication network.

Com'X:

A compact plug and play gateway and data logger and is an essential part of an entry level energy management system.

E

EcoStruxure Panel Server Universal (U-PaS):

A Wireless Concentrator, Modbus Gateway, and Energy Server.

Energy Reduction Maintenance Setting (ERMS):

Square D brand PowerPacT P-, R-Frame, and MasterPacT circuit breakers, manufactured by Schneider Electric, provide arc flash protection characteristics. Additional components can be integrated to increase the options available to reduce the arc flash incident energy (AFIE).

L

Low Voltage Current Transducer (LVCT):

The PowerLogic LVCTxxx series of 1 or 0.333 volt split-core current transducers provide secondary voltage AC proportional to the primary (sensed) current.

M

Maintenance Mode Switch (MMS):

A switch that is used to reduce the typical short-time delay (STD) from 0.30 seconds to 0.08 seconds or less. Used only in conjunction with trip units that have the Short-time Zone Selective Interlocking (ST-ZSI) capability.

MicroLogic:

The family of electronic trip systems available on molded case circuit breakers, insulated case circuit breakers, and low-voltage power circuit breakers.

Modbus Communication Interface Module (IFM):

This module, required for connection to the network, contains the Modbus address (1 to 99) declared by the user using the two rotary switches on the front of the unit. It automatically adapts (baud rate, parity) to the Modbus network in which it is installed.

N

NSX Cord:

A shielded communication cable consisting of two twisted pairs of stranded wire that is typically black/red and blue/white color. The NSX Cord has an RJ45 jack at one end, and four wires terminated into a small terminal block on the other end. This is used with PowerPacT H, J, or L breakers. If the terminal block is not needed, it can be removed.

U

Universal Logic Plug (ULP) Cable:

The Circuit Breaker ULP Cord has an RJ45 jack at one end, and at the other end, the four wires are ready to be connected into screw terminals of an accessory such

as a communication module. This is used with PowerPacT P, R, and MasterpacT NT and NW breakers to connect the BCM to the communication network.

Schneider Electric
1415 S. Roselle Road
Palatine, IL 60067
USA

888-778-2733

www.se.com

As standards, specifications, and design change from time to time,
please ask for confirmation of the information given in this publication.

© 1998 – 2023 Schneider Electric. All rights reserved.

2110CT9701