

Ground Fault Products
Portable GFCI Line Cords
Industrial Grade, Automatic and Manual
Set

HUBBELL

Features

- Unit must be reset by pushing the reset button upon plug in and after loss of primary power
- After a ground fault condition, unit must be reset by pushing the reset button
- Ideal for applications where operator injury might occur if equipment were to restart after a power failure



Ordering Information

Description	Length	UPC	Catalog Number
Circuit Guard® manual set portable GFCI line cord, 15A 120V AC	25' (762.0 cm)	783585690391	GFP25C15M

Listings

UL Listed
CSA Certified
IP21 Suitability

Specifications

Housing	PVC
Plug	PVC
Connector	PVC
Buttons	Rubber

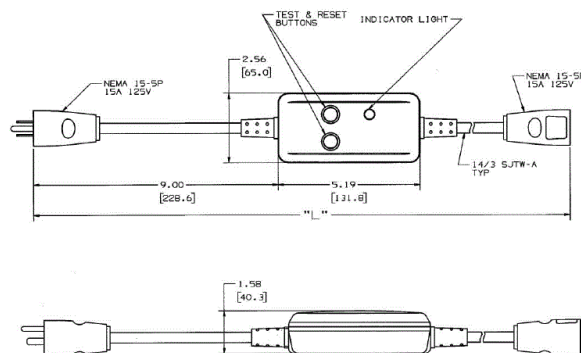

Online Resources

Customer Use Drawing
eCatalog
Installation Instructions

Dimensions in Inches (mm)

Hubbell Wiring Device-Kellems • Hubbell Incorporated (Delaware) • 40 Waterview Drive • Shelton, CT 06484

Phone (800) 288-6000 • Fax (800) 255-1031 • Specifications subject to change without notice.

