

FEED-THROUGH WIREWAY, NEMA TYPE 12

APPLICATION

With a variety of fittings and brackets, this traditional-design wireway is suitable for a broad range of industrial applications.

FEATURES

- Seams continuously welded and ground smooth
- No holes or knockouts
- Smooth, rounded edges on all sections and fittings
- Heavy butt hinges and external screw clamps
- Oil-resistant gasket and adhesive

SPECIFICATIONS

- 14 gauge steel covers and bodies
- 10 gauge steel end flanges

FINISH

ANSI 61 gray polyester powder finish inside and out over pretreated surfaces. Box connector is gray ANSI 61. Clamps and screws are plated.

INDUSTRY STANDARDS

UL 870; File No. E27524

NEMA/EEMAC Type 12

JIC standards EGP-1-1967 and EMP-1-1967

CSA, File No. 42184, Type 1

IEC 60529, IP54

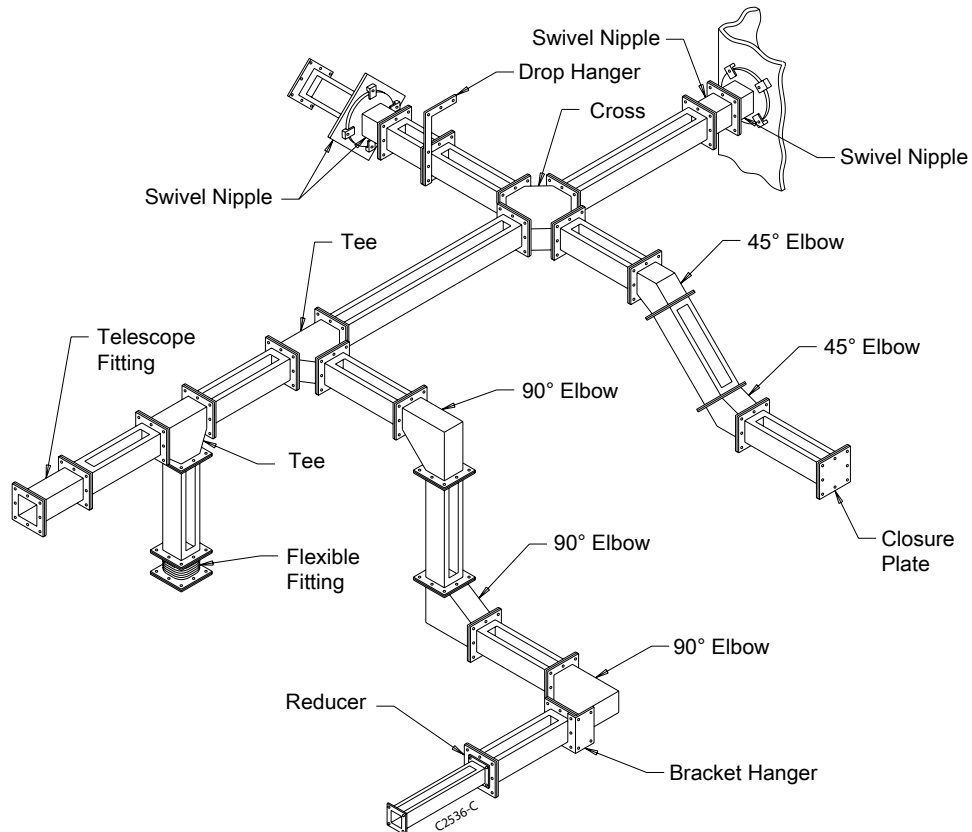

Standard Product Selection Matrix

Description	2.50 x 2.50 in. (64 x 64 mm)	4.00 x 4.00 in. (102 x 102 mm)	6.00 x 6.00 in. (152 x 152 mm)	8.00 x 8.00 in. (203 x 203 mm)
12.00-in. (305-mm) Straight Section	F22W12 ^{c,d}	F44W12 ^{c,d}	F66W12 ^{c,d}	F88W12 ^{c,d}
24.00-in. (610-mm) Straight Section	F22W24 ^{c,d}	F44W24 ^{c,d}	F66W24 ^{c,d}	F88W24 ^{c,d}
36.00-in. (914-mm) Straight Section	F22W36 ^{c,d}	F44W36 ^{c,d}	F66W36 ^{c,d}	F88W36 ^{c,d}
48.00-in. (1219-mm) Straight Section	F22W48 ^{c,d}	F44W48 ^{c,d}	F66W48 ^{c,d}	F88W48 ^{c,d}
60.00-in. (1524-mm) Straight Section	F22W60 ^{c,d}	F44W60 ^{c,d}	F66W60 ^{c,d}	F88W60 ^{c,d}
120.00-in. (3048-mm) Straight Section	F22W120 ^{c,d}	F44W120 ^{c,d}	F66W120 ^{c,d}	F88W120 ^{c,d}
90° Elbow	F22WE90 ^{c,d}	F44WE90 ^{c,d}	F66WE90 ^{c,d}	F88WE90 ^{c,d}
45° Elbow	F22WE45 ^{c,d}	F44WE45 ^{c,d}	F66WE45 ^{c,d}	F88WE45 ^{c,d}
22.50° Elbow	F22WE225 ^{c,d}	F44WE225 ^{c,d}	F66WE225 ^{c,d}	F88WE225 ^{c,d}
Cross	F22WC ^{c,d}	F44WC ^{c,d}	F66WC ^{c,d}	F88WC ^{c,d}
Closure Plate	F22WP ^c	F44WP ^c	F66WP ^c	F88WP ^c
Tee	F22WT ^{c,d}	F44WT ^{c,d}	F66WT ^{c,d}	F88WT ^{c,d}
Telescope Fitting	F22WA	F44WA	F66WA	F88WA
Cutoff Fitting	F22WX	F44WX	F66WX	F88WX
Swivel Nipple (Box Entry)	F22WSA ^{c,d}	F44WSA ^{c,d}	F66WSA ^{c,d}	F88WSA ^{c,d}
Swivel Nipple (Regular)	F22WSC ^{c,d}	F44WSC ^{c,d}	F66WSC ^{c,d}	F88WSC ^{c,d}
1.00-in. (25-mm) Nipple	F22WN1 ^{c,d}	F44WN1 ^{c,d}	F66WN1 ^{c,d}	F88WN1 ^{c,d}
2.00-in. (51-mm) Nipple	F22WN2 ^{c,d}	F44WN2 ^{c,d}	F66WN2 ^{c,d}	F88WN2 ^{c,d}
3.00-in. (76-mm) Nipple	F22WN3 ^{c,d}	F44WN3 ^{c,d}	F66WN3 ^{c,d}	F88WN3 ^{c,d}
6.00-in. (152-mm) Nipple	F22WN6 ^{c,d}	F44WN6 ^{c,d}	F66WN6 ^{c,d}	F88WN6 ^{c,d}
Box Connector	F22WB	F44WB	F66WB	F88WB
Flexible Fitting	F22WFF	F44WFF	F66WFF	F88WFF
Reducer Bushings: 4.00-in. (102-mm) to 2.50-in. (64-mm) Center Hole	—	F44WR22 ^{c,d}	—	—
Reducer Bushings: 4.00-in. (102-mm) to 2.50-in. (64-mm) Edge Hole	—	F44WRE22 ^{c,d}	—	—
Reducer Bushings: 6.00-in. (152-mm) to 4.00-in. (102-mm) Center Hole	—	—	F66WR44 ^{c,d}	—
Reducer Bushings: 6.00-in. (152-mm) to 4.00-in. (102-mm) Edge Hole	—	—	F66WRE44 ^{c,d}	—
Reducer Bushings: 8.00-in. (203-mm) to 6.00-in. (152-mm) Center Hole	—	—	—	F88WR66 ^{c,d}
8.00-in. (203-mm) to 6.00-in. (152-mm) Edge Hole	—	—	—	F88WRE66 ^{c,d}
Reducer Bushings: 8.00-in. (203-mm) to 4.00-in. (102-mm) Center Hole	—	—	—	F88WR44 ^{c,d}
Reducer Bushings: 8.00-in. (203-mm) to 4.00-in. (102-mm) Edge Hole	—	—	—	F88WRE44 ^{c,d}
Drop Hanger	F22HD	F44HD	F66HD	F88HD
Bracket Hanger	F22HB	F44HB	F66HB	F88HB
Barrier Kit, bolton barrier 60.00 in. (1524 mm)	—	F44BK60	F66BK60	F88BK60
Barrier, bracketmounted Each barrier 60.00 in. (1524 mm) ^a	—	F44B360	F66B560	—
Barrier Brackets, 2 compartment ^a	—	F44BB2C	F66BB2C	—
Barrier Brackets, 3 compartment ^a	—	F44BB3C	F66BB3C	—
Gasket and Screws ^b	F22WG	F44WG	F66WG	F88WG

^a Package consists of five barriers or five barrier brackets. Each barrier is 60-in. long.

^b Standard packages of wireway contain one gasket and one set of screws to join sections, except "Cross" fittings which contain three of each, "Tee" fittings which contain two of each and Telescope" fittings which contain none. Additional gasket and screw sets may be ordered by catalog number.

^c Certified by Canadian Standards Association.

^d UL 870

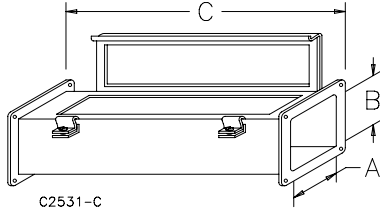
STRAIGHT SECTION

C2531-C

Available in lengths from 12.00 in. (305 mm) to 120.00 in. (3048 mm).

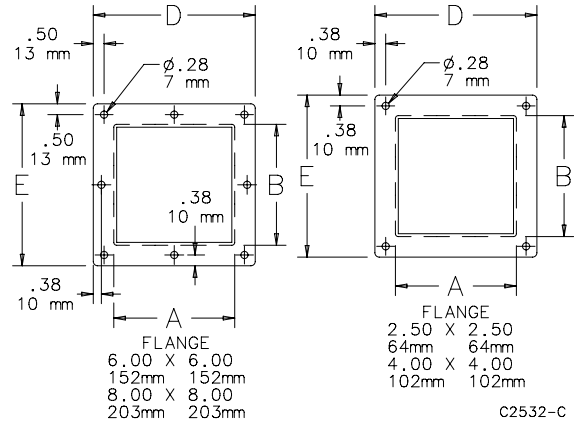
BULLETIN: F20

C2532-C

Straight Section

Catalog Number	AxBxC in.	AxBxC mm	D (in.)	D (mm)	E (in.)	E (mm)
F22W12	2.50 x 2.50 x 12.00	64 x 64 x 305	3.88	99	3.88	99
F22W24	2.50 x 2.50 x 24.00	64 x 64 x 610	3.88	99	3.88	99
F22W36	2.50 x 2.50 x 36.00	64 x 64 x 914	3.88	99	3.88	99
F22W48	2.50 x 2.50 x 48.00	64 x 64 x 1219	3.88	99	3.88	99
F22W60	2.50 x 2.50 x 60.00	64 x 64 x 1524	3.88	99	3.88	99
F22W120	2.50 x 2.50 x 120.00	64 x 64 x 3048	3.88	99	3.88	99
F44W12	4.00 x 4.00 x 12.00	102 x 102 x 305	5.38	137	5.38	137
F44W24	4.00 x 4.00 x 24.00	102 x 102 x 610	5.38	137	5.38	137
F44W36	4.00 x 4.00 x 36.00	102 x 102 x 914	5.38	137	5.38	137
F44W48	4.00 x 4.00 x 48.00	102 x 102 x 1219	5.38	137	5.38	137
F44W60	4.00 x 4.00 x 60.00	102 x 102 x 1524	5.38	137	5.38	137
F44W120	4.00 x 4.00 x 120.00	102 x 102 x 3048	5.38	137	5.38	137
F66W12	6.00 x 6.00 x 12.00	152 x 152 x 305	7.62	194	7.62	194
F66W24	6.00 x 6.00 x 24.00	152 x 152 x 610	7.62	194	7.62	194
F66W36	6.00 x 6.00 x 36.00	152 x 152 x 914	7.62	194	7.62	194
F66W48	6.00 x 6.00 x 48.00	152 x 152 x 1219	7.62	194	7.62	194
F66W60	6.00 x 6.00 x 60.00	152 x 152 x 1524	7.62	194	7.62	194
F66W120	6.00 x 6.00 x 120.00	152 x 152 x 3048	7.62	194	7.62	194
F88W12	8.00 x 8.00 x 12.00	203 x 203 x 305	9.62	244	9.62	244
F88W24	8.00 x 8.00 x 24.00	203 x 203 x 610	9.62	244	9.62	244
F88W36	8.00 x 8.00 x 36.00	203 x 203 x 914	9.62	244	9.62	244
F88W48	8.00 x 8.00 x 48.00	203 x 203 x 1219	9.62	244	9.62	244
F88W60	8.00 x 8.00 x 60.00	203 x 203 x 1524	9.62	244	9.62	244
F88W120	8.00 x 8.00 x 120.00	203 x 203 x 3048	9.62	244	9.62	244

All dimensions are to outside surfaces. Allow .12 in. (3 mm) additional for gasket at joints.

Certified by Canadian Standards Association.

FLEXIBLE FITTING

Isolates a wireway run from shock and vibration. Compensates for misalignment. Used where an odd angle is required (but not to exceed 90 degrees). Permits movement of a machine or control station connected to a wireway run. Hypalon bellow with steel flanges.

BULLETIN: F20

Catalog Number	AxB in./mm
F22WFF	2.50 x 2.50 64 x 64
F44WFF	4.00 x 4.00 102 x 102
F66WFF	6.00 x 6.00 152 x 152
F88WFF	8.00 x 8.00 203 x 203

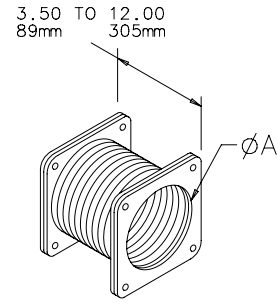

87797188

TELESCOPE FITTING

Length is easily adjustable from 1.50 in. (38 mm) to 13.50 in. (343 mm). No cutting or welding required.

BULLETIN: F20

Catalog Number	AxB in./mm
F22WA	2.50 x 2.50 64 x 64
F44WA	4.00 x 4.00 102 x 102
F66WA	6.00 x 6.00 152 x 152
F88WA	8.00 x 8.00 203 x 203

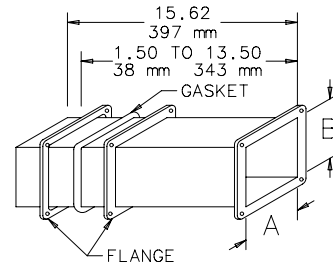

87797176

All dimensions are to outside surfaces. Allow .12 in. (3 mm) additional for gasket at joints.

CUT-OFF FITTING

For lengths up to 12.00 in. (305 mm). Shorten body to desired length and weld on flange.

BULLETIN: F20

Catalog Number	AxB in./mm
F22WX	2.50 x 2.50 64 x 64
F44WX	4.00 x 4.00 102 x 102
F66WX	6.00 x 6.00 152 x 152
F88WX	8.00 x 8.00 203 x 203

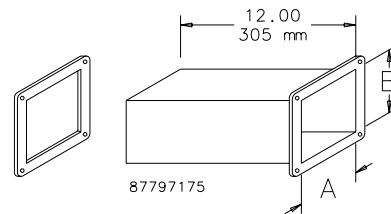

87797175

All dimensions are to outside surfaces. Allow .12 in. (3 mm) additional for gasket at joints.

CROSS

BULLETIN: F20

Catalog Number	AxB in./mm	G in./mm	K in./mm
F22WC	2.50 x 2.50 64 x 64	8.50 216	4.25 108
F44WC	4.00 x 4.00 102 x 102	10.00 254	5.00 127
F66WC	6.00 x 6.00 152 x 152	12.00 305	6.00 152
F88WC	8.00 x 8.00 203 x 203	14.00 356	7.00 178

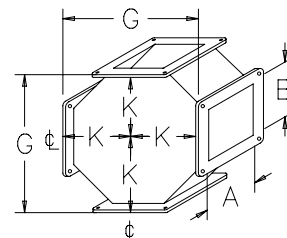

87797183

All dimensions are to outside surfaces. Allow .12 in. (3 mm) additional for gasket at joints. Dimension K are from intersection of center lines.

Certified by Canadian Standards Association.

22.50-DEGREE ELBOW

BULLETIN: F20

Catalog Number	AxB in./mm	H in./mm
F22WE225	2.50 x 2.50 64 x 64	3.26 83
F44WE225	4.00 x 4.00 102 x 102	4.13 105
F66WE225	6.00 x 6.00 152 x 152	5.15 131
F88WE225	8.00 x 8.00 203 x 203	6.35 161

All dimensions are to outside surfaces. Allow .12 in. (3 mm) additional for gasket at joints.
Certified by Canadian Standards Association.

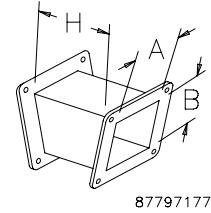

87797177

45-DEGREE ELBOW

BULLETIN: F20

Catalog Number	AxB in./mm	H in./mm	J in./mm
F22WE45	2.50 x 2.50 64 x 64	2.50 64	2.00 51
F44WE45	4.00 x 4.00 102 x 102	3.25 83	2.44 62
F66WE45	6.00 x 6.00 152 x 152	4.25 108	3.00 76
F88WE45	8.00 x 8.00 203 x 203	5.25 133	3.62 92

All dimensions are to outside surfaces. Allow .12 in. (3 mm) additional for gasket at joints. Dimension J is from intersection of center lines.
Certified by Canadian Standards Association.

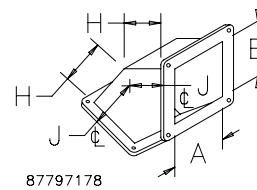

87797178

90-DEGREE ELBOW

BULLETIN: F20

Catalog Number	AxB in./mm	F in./mm	K in./mm
F22WE90	2.50 x 2.50 64 x 64	5.50 140	4.25 108
F44WE90	4.00 x 4.00 102 x 102	7.00 178	5.00 127
F66WE90	6.00 x 6.00 152 x 152	9.00 229	6.00 152
F88WE90	8.00 x 8.00 203 x 203	11.00 279	7.00 178

All dimensions are to outside surfaces. Allow .12 in. (3 mm) additional for gasket at joints. Dimension K is from intersection of center lines.
Certified by Canadian Standards Association.

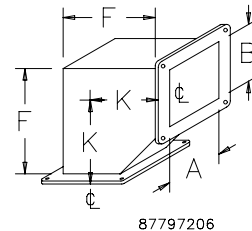

87797206

TEE

BULLETIN: F20

Catalog Number	AxB in./mm	F in./mm	G in./mm	K in./mm
F22WT	2.50 x 2.50 64 x 64	5.50 140	8.50 216	4.25 108
F44WT	4.00 x 4.00 102 x 102	7.00 178	10.00 254	5.00 127
F66WT	6.00 x 6.00 152 x 152	9.00 229	12.00 305	6.00 152
F88WT	8.00 x 8.00 203 x 203	11.00 279	14.00 356	7.00 178

All dimensions are to outside surfaces. Allow .12 in. (3 mm) additional for gasket at joints. Dimension K is from intersection of center lines.
Certified by Canadian Standards Association.

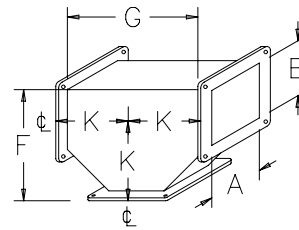

87797182

CLOSURE PLATE

Used to seal the end on a wireway section or run.

BULLETIN: F20

Catalog Number	D in./mm	E in./mm
F22WP	3.88 99	3.88 99
F44WP	5.38 137	5.38 137
F66WP	7.62 194	7.62 194
F88WP	9.62 244	9.62 244

All dimensions are to outside surfaces. Allow .12 in. (3 mm) additional for gasket at joints.

Certified by Canadian Standards Association.

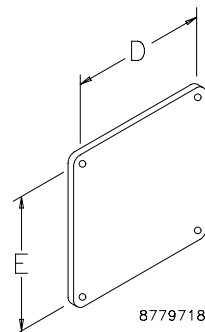

REDUCER BUSHINGS

Used to reduce to a smaller wireway size. The center hole bushing centers the two wireway sizes relative to each other while the edge hole bushing keeps the top surfaces even.

BULLETIN: F20

Center Hole

Catalog Number	AxB in.	AxB mm	D (in.)	D (mm)	E (in.)	E (mm)
F44WR22	2.00 x 2.00	51 x 51	5.38	137	5.38	137
F66WR44	4.00 x 4.00	102 x 102	7.62	194	7.62	194
F88WR44	4.00 x 4.00	102 x 102	9.62	244	9.62	244
F88WR66	6.00 x 6.00	152 x 152	9.62	244	9.62	244

All dimensions are to outside surfaces. Allow .12 in. (3 mm) additional for gasket at joints.

Certified by Canadian Standards Association.

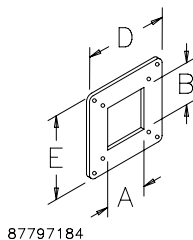

Edge Hole

Catalog Number	AxB in.	AxB mm	D (in.)	D (mm)	E (in.)	E (mm)
F44WRE22	2.00 x 2.00	51 x 51	5.38	137	5.38	137
F66WRE44	4.00 x 4.00	102 x 102	7.62	194	7.62	194
F88WRE44	4.00 x 4.00	102 x 102	9.62	244	9.62	244
F88WRE66	6.00 x 6.00	152 x 152	9.62	244	9.62	244

All dimensions are to outside surfaces. Allow .12 in. (3 mm) additional for gasket at joints.

Certified by Canadian Standards Association.

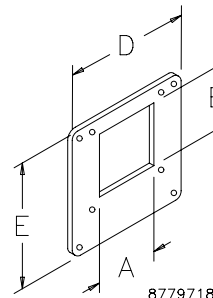

NIPPLE

BULLETIN: F20

Catalog Number	AxBxC in.	AxBxC mm
F22WN1	2.50 x 2.50 x 1.00	64 x 64 x 25
F22WN2	2.50 x 2.50 x 2.00	64 x 64 x 51
F22WN3	2.50 x 2.50 x 3.00	64 x 64 x 76
F22WN6	2.50 x 2.50 x 6.00	64 x 64 x 152
F44WN1	4.00 x 4.00 x 1.00	102 x 102 x 25
F44WN2	4.00 x 4.00 x 2.00	102 x 102 x 51
F44WN3	4.00 x 4.00 x 3.00	102 x 102 x 76
F44WN6	4.00 x 4.00 x 6.00	102 x 102 x 152
F66WN1	6.00 x 6.00 x 1.00	152 x 152 x 25
F66WN2	6.00 x 6.00 x 2.00	152 x 152 x 51
F66WN3	6.00 x 6.00 x 3.00	152 x 152 x 76
F66WN6	6.00 x 6.00 x 6.00	152 x 152 x 152
F88WN1	8.00 x 8.00 x 1.00	203 x 203 x 25
F88WN2	8.00 x 8.00 x 2.00	203 x 203 x 51
F88WN3	8.00 x 8.00 x 3.00	203 x 203 x 76
F88WN6	8.00 x 8.00 x 6.00	203 x 203 x 152

Certified by Canadian Standards Association.

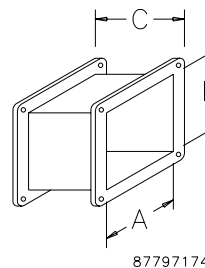

SWIVEL NIPPLES

Allows wireway run to be adjusted to any angle. Regular type is used between adjacent wireway sections or fittings while the box entry type is used when entering an enclosure.

BULLETIN: F20

Regular

Catalog Number	AxB in.	AxB mm
F22WSC	2.50 x 2.50	64 x 64
F44WSC	4.00 x 4.00	102 x 102
F66WSC	6.00 x 6.00	152 x 152
F88WSC	8.00 x 8.00	203 x 203

All dimensions are to outside surfaces. Allow .12 in. (3 mm) additional for gasket at joints.

Certified by Canadian Standards Association.

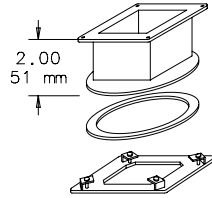

87797186

Box Entry

Catalog Number	AxB in.	AxB mm
F22WSA	2.50 x 2.50	64 x 64
F44WSA	4.00 x 4.00	102 x 102
F66WSA	6.00 x 6.00	152 x 152
F88WSA	8.00 x 8.00	203 x 203

All dimensions are to outside surfaces. Allow .12 in. (3 mm) additional for gasket at joints.

Certified by Canadian Standards Association.

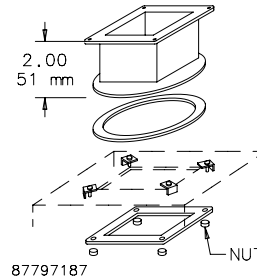

87797187

HANGERS

Hangers are used to support a wireway run. The drop hanger is normally attached to an overhead beam or ceiling while the bracket hanger can be used for wall, floor or ceiling installations.

BULLETIN: F20

Drop Hanger

Catalog Number	S (in.)	S (mm)	T (in.)	T (mm)
F22HD	9.25	235	4.50	114
F44HD	11.75	298	6.00	152
F66HD	15.25	387	8.12	206
F88HD	20.56	522	12.12	308

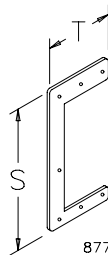

87797192

Bracket Hanger

Catalog Number	P (in.)	P (mm)	R (in.)	R (mm)	U (in.)	U (mm)
F22HB	4.62	117	3.62	92	4.38	111
F44HB	6.12	155	3.62	92	5.88	149
F66HB	8.25	210	3.62	92	7.88	200
F88HB	10.25	260	3.62	92	11.25	286

All dimensions are to outside surfaces. Allow .12 in. (3 mm) additional for gasket at joints.

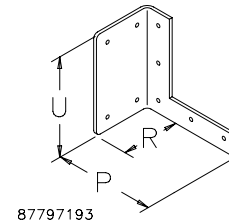

87797193

BOX CONNECTOR

When wireway enters an enclosure, a box connector should be used on the inside of the enclosure to ensure a tight and stable seal.

BULLETIN: F20

Catalog Number	D in./mm	E in./mm
F22WB	3.88 99	3.88 99
F44WB	5.38 137	5.38 137
F66WB	7.62 194	7.62 194
F88WB	9.62 244	9.62 244

All dimensions are to outside surfaces. Allow .12 in. (3 mm) additional for gasket at joints.

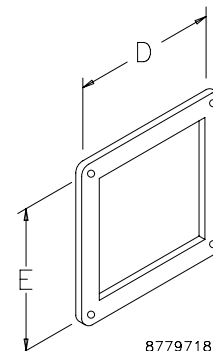

87797180

BARRIER KITS

Divides wireway into two or three compartments. Plated spring steel brackets hold barriers in place by friction fit inside wireway. Order barrier and bracket separately. Recommended spacing increments of 3 ft.

W = 3.00 in. (76 mm) for 4.00 x 4.00 in. (102 x 102 mm)
 W = 4.50 in. (114 mm) for 6.00 x 6.00 in. (152 x 152 mm)

BULLETIN: F10, F20

Compartment Barriers

Catalog Number	W (in.)	W (mm)
F44B360	3.00	76
F66B560	4.50	114

All dimensions are to outside surfaces. Allow .12 in. (3 mm) additional for gasket at joints.

Package consists of five barriers

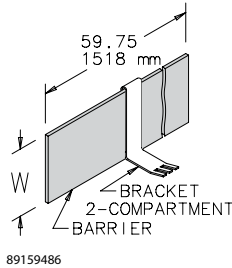

Two-Compartment Brackets

Catalog Number	W (in.)	W (mm)
F44BB2C	3.00	76
F66BB2C	4.50	114

All dimensions are to outside surfaces. Allow .12 in. (3 mm) additional for gasket at joints.

Package consists of five barrier brackets.

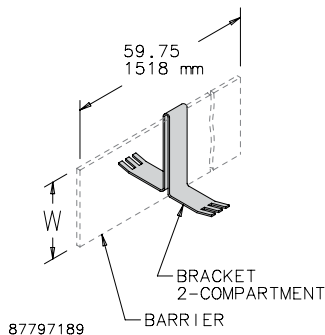

Three-Compartment Brackets

Catalog Number	W (in.)	W (mm)
F44BB3C	3.00	76
F66BB3C	4.50	114

All dimensions are to outside surfaces. Allow .12 in. (3 mm) additional for gasket at joints.

Package consists of five barrier brackets.

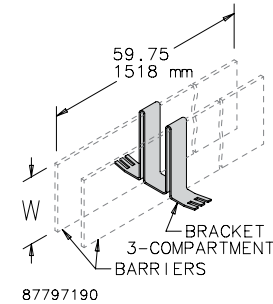

Bolt-On Barriers

Catalog Number	W (in.)	W (mm)
F44BK60	3.00	76
F66BK60	4.50	114
F88BK60	6.00	152

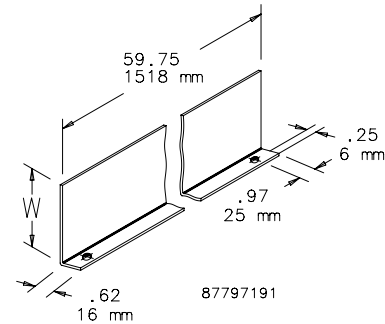

GASKET AND SCREWS

Standard packages of wireway contain one gasket and one set of screws to join sections, except Cross Fittings which contain three of each, Tee Fittings which contain two of each and Telescope Fittings which contain none. Additional gasket and screw sets may be ordered by catalog number.

BULLETIN: F20

Catalog Number	AxB in./mm
F22WG	2.50 x 2.50 64 x 64
F44WG	4.00 x 4.00 102 x 102
F66WG	6.00 x 6.00 152 x 152
F88WG	8.00 x 8.00 203 x 203