

# Square D General Purpose Relays

Class 8501R miniature control relays

- 8501RS14 standard
- 8501RS24 low level
- 8501RS34 hermetically sealed

Catalog  
**2014**



 **SQUARE D**™

by Schneider Electric

---

■ Specifications . . . . .	3
■ References . . . . .	5
■ Dimensions . . . . .	7
■ Wiring diagrams . . . . .	8

### General Specifications

<b>Conforming to standards</b>		IEC/EN 61810-1, UL 508, CSA C22-2 n° 14
<b>Product certifications</b>	8501RS(D)14●●●	cULus File E3190 CCN NLDX, NLDX7; cURus File E3190 CCN NLDX2, NLDX8; CSA; CE; RoHS compliant
	8501RS(D)24●●●	
	8501RS(D)34●●●	
<b>Ambient air temperature</b> around the device	Storage	°C (F) - 40 to + 85 (-40 to +185)
	Operation	°C (F) - 40 to + 55 (-40 to +131)
<b>Vibration resistance</b> conforming to IEC/EN 60068-2-6	In operation	3 gn (35 to 150 Hz) and ± 1 mm (10 to 35 Hz) with and without retention clip
	Not operating	5 gn (35 to 150 Hz) and ± 1 mm (10 to 35 Hz) with and without retention clip
<b>Degree of protection</b>	Conforming to IEC/EN 60529	8501RS(D)14●●●, 8501RS(D)24●●●: IP40
	Per ISA 12.12.01	8501RS(D)34●●●: Hermetically sealed
<b>Shock resistance</b> conforming to IEC/EN 60068-2-27	In operation	10 gn (11 ms)
	Not operating	30 gn (11 ms)
<b>Protection category</b>		8501RS(D)14●●●, 8501RS(D)24●●●: RT I
		8501RS(D)34●●●: RT V
<b>Mounting position</b>		Any

### Insulation Specifications

<b>Rated insulation voltage (Ui)</b>	V	250 (IEC), 300 (UL, CSA)	
<b>Rated impulse withstand voltage (Uimp)</b>	kV	2.5 (1.2/50 μs)	
<b>Dielectric strength</b> (rms voltage)	Between coil and contact	Vac	2000
	Between poles	Vac	2000
	Between contacts	Vac	1300

### Contact Specifications

Relay type		8501RS14●●● 8501RSD14●●●	8501RS24●●● 8501RSD24●●●	8501RS34●●● 8501RSD34●●●		
<b>Number and type of contacts</b>		4 C/O	4 C/O low level - bifurcated	4 C/O		
<b>Contact materials</b>		Ag alloy with Au flash	Ag with Au flash -bifurcated	Ag Alloy		
<b>Conventional thermal current (Ith)</b>	For ambient temperature ≤ 55°C	A	6	3	5	
<b>Rated operational current</b>	Conforming to IEC in utilization categories AC-1 and DC-1	NO	A	6 at 250 Vac / 28 Vdc	2 at 250 Vac / 28 Vdc	–
		NC	A	3 at 250 Vac / 28 Vdc	1 at 250 Vac / 28 Vdc	–
	Conforming to UL	Resistive	A	6 at 277 Vac (200k cycles) 8 at 120 Vac (200k cycles) 8 at 30 Vdc (200k cycles)	3 at 277 Vac (100k cycles) <sup>(1)</sup> 3 at 120 Vdc (100k cycles) <sup>(1)</sup> 3 at 30 Vdc (100k cycles) <sup>(1)</sup>	5 at 240 Vac (100k cycles) 5 at 120 Vac (100k cycles) 5 at 30 Vdc (100k cycles)
		Motor	HP	1/3 at 120 Vac (6k cycles) 1/2 at 277 Vac (6k cycles)	1/16 at 120 Vac (6k cycles) <sup>(1)</sup> 2.8 A FLA at 120 Vac	–
	Pilot Duty		B300	5 A make, 0.5 A break, 3 A continuous at 120 Vac <sup>(1)</sup>	–	
<b>Minimum switching requirement</b>		mA	10 at 17 Vdc	3 at 5 Vdc	100 at 5 Vdc	
<b>Maximum switching voltage</b>		V	250 Vac / 28 Vdc (IEC); 300 Vac / 30 Vdc (UL)	240 Vac / 30 Vdc (UL)		
<b>Switching capacity</b>	Maximum	Vac	VA	1500	750	1200
		Vdc	W	168	84	150
	Minimum	mW	170	15	500	
<b>Maximum operating rate</b>			18,000			
In operating cycles/hour	No-load		1200			
	Under load					
<b>Utilization coefficient</b>			20%			
<b>Mechanical durability</b>		Cycles	10,000,000			
<b>Electrical durability</b>	Resistive load		100,000 (unless otherwise specified)			
	Inductive load		See curve below			

(1) When mounted horizontally

### Performance curves (for 8501RS(D)14●●● and 8501RS(D)24●●● only)

**Electrical durability of contacts**  
Resistive load (AC)

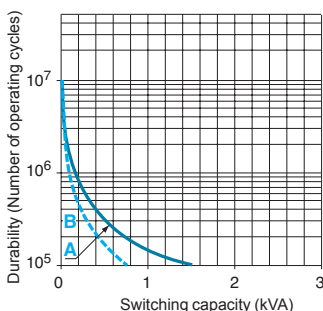

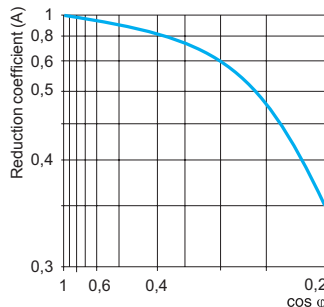

Reduction coefficient for inductive load (AC)  
(depending on power factor cos φ)

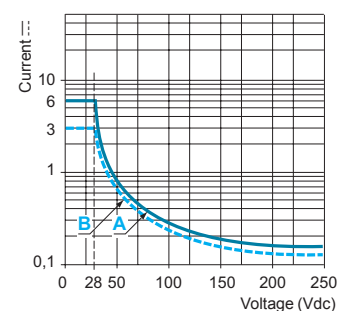

Maximum switching capacity on resistive load (DC)

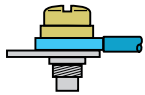

A 8501RS(D)14●●● B 8501RS(D)24●●● Durability (inductive load) = durability (resistive load) x reduction coefficient.

Coil specifications			8501RS14●●●, 8501RS24●●●, 8501RSD14●●●, 8501RSD24●●●								8501RS34●●●, 8501RSD34●●●								
Average consumption	AC	VA	0.9–1.2								0.9–1.2								
	DC	W	0.8–1.1								0.8–1.1								
Drop-out voltage threshold	AC		≥ 0.15 U <sub>c</sub>								≥ 0.3 U <sub>c</sub>								
	DC		≥ 0.1 U <sub>c</sub>								≥ 0.1 U <sub>c</sub>								
Response time Operate time	AC	ms	20 (max.)								20 (max.)								
	DC	ms	20 (max.)								20 (max.)								
	Release time	AC	ms	20 (max.)								20 (max.)							
		DC	ms	20 (max.)								20 (max.)							
Control circuit voltage U <sub>c</sub>	V		6	12	24	48	110	120	240	6	12	24	48	110	120	240			
Relay control voltage codes			–	V51	V53	V56	V60	–	–	V50	V51	V53	V56	V60	–	–			
DC supply	Average resistance at 20 °C ± 10%	Ω	–	160	650	2560	13440	–	–	40	160	650	2600	11000	–	–			
		Operating voltage limits	Min.	Vdc	–	9.6	19.2	38.4	88	–	–	4.5	9	18	36	82.5	–	–	
			Max.	Vdc	–	13.2	26.4	52.8	121	–	–	6.6	13.2	26.4	52.8	121	–	–	
Relay control voltage codes			–	–	V14	V17	–	V20	V24	V35	V36	V14	V17	–	V20	V24			
AC supply	Average resistance at 20 °C ± 15%	Ω	–	–	177	708	–	3630	17720	10.5	43	160	668	–	3900	9100			
		Operating voltage limits	Min.	Vac	–	–	19.2	38.4	–	96	192	4.8	9.6	19.2	38.4	–	96	192	
			Max.	Vac	–	–	26.4	52.8	–	132	264	6.6	13.2	26.4	52.8	–	132	264	
Socket specifications			8501NR45								RXZE2S114S								
Socket type			8501NR45								RXZE2S114S								
Relay types used			8501RS(D)14●●● 8501RS(D)24●●● 8501RS(D)34●●●								8501RS(D)14●●● 8501RS(D)24●●● 8501RS(D)34●●●								
Contact terminal arrangement			Separate																
Wire connection method			Screw clamp terminals								Spring clamp terminals								
Product certifications			cURus File E66924 CCN SWIV2, SWIV8; CSA; CE; RoHS compliant								cURus File E172326 CCN SWIV2, SWIV8; CSA; CE; RoHS compliant								
Conforming to standards			IEC 61984, UL 508, CSA 22.2 No. 14																
Electrical specifications																			
Conventional thermal current (I <sub>th</sub> )	A		10 at 300 Vac (UL)								6 at 250 Vac (UL / IEC)								
Insulation specifications																			
Between adjacent output contacts	Vrms		2000								2500								
Between input and output contacts	Vrms		2000								2500								
Between contacts and DIN rail	Vrms		2000								2500								
General specifications																			
Ambient air temperature around the device	Storage	°C (°F)	- 40 to + 85 (- 40 to + 185)																
	Operation	°C (°F)	- 40 to + 55 (- 40 to + 131)																
Degree of protection	Conforming to IEC/EN 60529		IP 20																
Connection	Solid wire without cable end	1 conductor	0.5 to 2.5 mm <sup>2</sup> - AWG 20 to AWG 14								0.5 to 1.5 mm <sup>2</sup> AWG 20 to AWG 16								
		2 conductors	0.5 to 2.5 mm <sup>2</sup> - AWG 20 to AWG 14																
	Flexible wire with cable end	1 conductor	0.5 to 2.5 mm <sup>2</sup> - AWG 20 to AWG 14								0.5 to 1.5 mm <sup>2</sup> AWG 20 to AWG 16								
		2 conductors	0.5 to 2.5 mm <sup>2</sup> - AWG 20 to AWG 14								0.5 to 1.5 mm <sup>2</sup> AWG 20 to AWG 16								
Maximum tightening torque / Screw size	Lb-ft (N•m)		0.6-0.7 (0.8-1) / M3 screw								–								
Mounting			On 35 mm DIN rail / on panel																
Mounting on DIN rail			By plastic clip								By metal compression spring								
Terminal referencing			IEC, NEMA																
Compatible with hold down clip			Yes								No								
Compatible with restraining strap			Yes								No								
Wire connection method			Screw clamp terminals								Spring clamp terminals								
																			

# Square D General Purpose Relays

## Class 8501R miniature control relays



8501RS14V20



8501RSD24P14V60



8501RS34V20

References					
Control circuit voltage	Number and type of contacts - Thermal current (Ith)				
	4 C/O - 6 A		4 C/O - 3 A		
	Unit reference	Weight kg/lb	Unit reference	Weight kg/lb	
<b>Miniature control relays with standard cover (sold in lots of 1)</b>					
12 Vdc	8501RSD14V51	0.037/0.082	8501RSD24V51	0.037/0.082	
24 Vdc	8501RSD14V53	0.037/0.082	8501RSD24V53	0.037/0.082	
48 Vdc	8501RSD14V56	0.037/0.082	8501RSD24V56	0.037/0.082	
110 Vdc	8501RSD14V60	0.037/0.082	8501RSD24V60	0.037/0.082	
24 Vac	8501RS14V14	0.037/0.082	8501RS24V14	0.037/0.082	
120 Vac	8501RS14V20	0.037/0.082	8501RS24V20	0.037/0.082	
240 Vac	8501RS14V24	0.037/0.082	8501RS24V24	0.037/0.082	
<b>Miniature control relays with standard cover and LED (sold in lots of 1)</b>					
12 Vdc	8501RSD14P14V51	0.037/0.082	8501RSD24P14V51	0.037/0.082	
24 Vdc	8501RSD14P14V53	0.037/0.082	8501RSD24P14V53	0.037/0.082	
48 Vdc	8501RSD14P14V56	0.037/0.082	8501RSD24P14V56	0.037/0.082	
110 Vdc	8501RSD14P14V60	0.037/0.082	8501RSD24P14V60	0.037/0.082	
24 Vac	8501RS14P14V14	0.037/0.082	8501RS24P14V14	0.037/0.082	
120 Vac	8501RS14P14V20	0.037/0.082	8501RS24P14V20	0.037/0.082	
240 Vac	8501RS14P14V24	0.037/0.082	8501RS24P14V24	0.037/0.082	
Control circuit voltage	Number and type of contacts - Thermal current (Ith)				
	4 C/O - 5 A				
	Unit reference			Weight kg/lb	
<b>Hermetically sealed miniature control relays (sold in lots of 1)</b>					
6 Vdc	8501RSD34V50			0.045/0.099	
12 Vdc	8501RSD34V51			0.045/0.099	
24 Vdc	8501RSD34V53			0.045/0.099	
48 Vdc	8501RSD34V56			0.045/0.099	
110 Vdc	8501RSD34V60			0.045/0.099	
6 Vac	8501RS34V35			0.045/0.099	
12 Vac	8501RS34V36			0.045/0.099	
24 Vac	8501RS34V14			0.045/0.099	
48 Vac	8501RS34V17			0.045/0.099	
110 Vac	8501RS34V20			0.045/0.099	
240 Vac	8501RS34V24			0.045/0.099	



8501NR45 +  
Relay 8501RS14V20



8501NR45 +  
Relay 8501RSD24P14V60



8501NH45

### References (continued)

#### Sockets

Contact terminal arrangement	Connection	Relay type	Sold in lots of	Unit reference	Weight kg/lb
Separate	Screw clamp terminals	8501RS(D)14●●●●	1	8501NR45	0.050/0.110
		8501RS(D)24●●●●			
		8501RS(D)34●●●●			
	Spring clamp terminals	8501RS(D)14●●●●	10	8501NR45B <sup>(1)</sup>	0.050/0.110
		8501RS(D)24●●●●			
		8501RS(D)34●●●●			

(1) Please note that the "B" suffix only designates quantities of 10 and is not printed on the socket.

#### Accessories

Description	For use with	Sold in lots of	Unit reference	Weight kg/lb
Metal hold-down clip	8501NR45 socket	10	8501NH45	0.001/0.002
Clip-in ID tags	RXZE2S114S socket	10	RSZL300	0.001/0.002

**Dimensions: inches (mm)**

Miniature control relays

8501RS(D)14●●● / 8501RS(D)24●●●

8501RS(D)34●●●

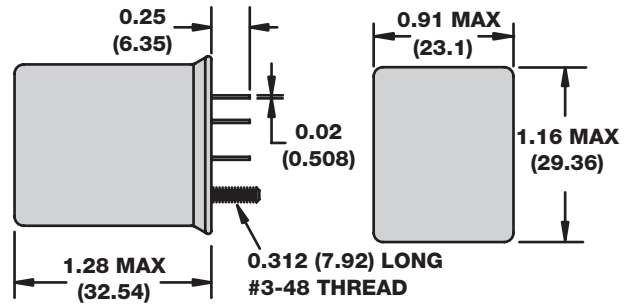
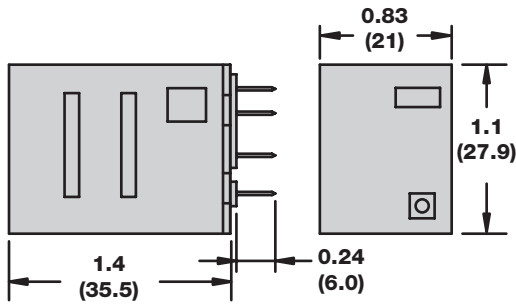

**Sockets**

8501NR45

RXZE2S114S

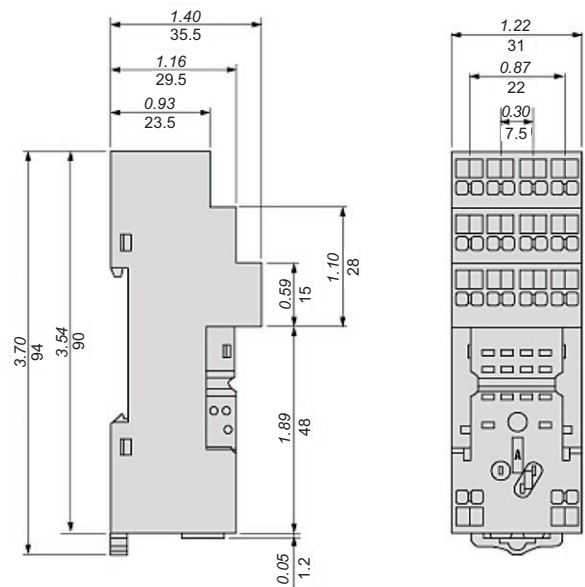
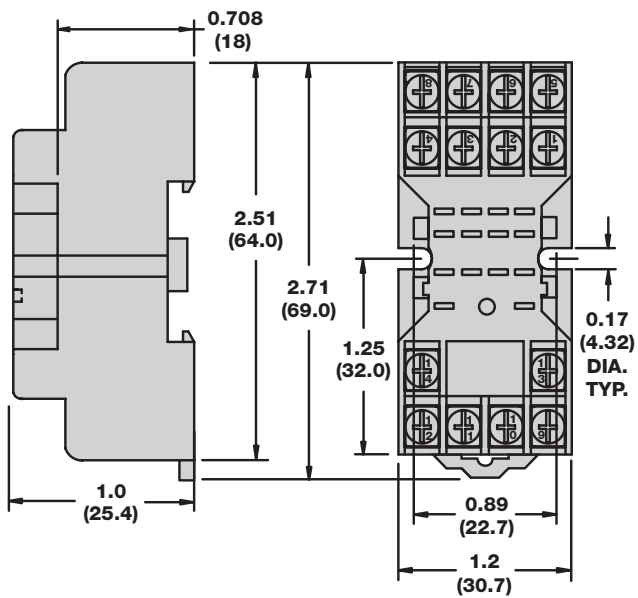

## Wiring diagrams

### Miniature control relays

8501RS(D)14... / 8501RS(D)24...

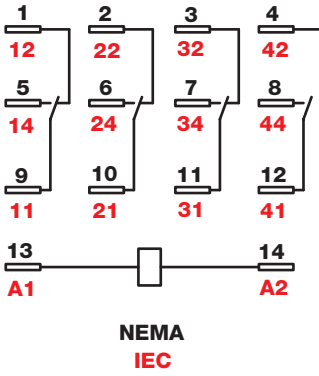

8501RS(D)34...

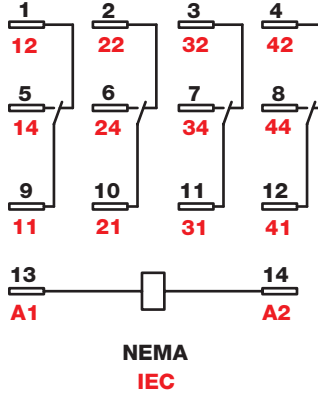

### Sockets

8501NR45

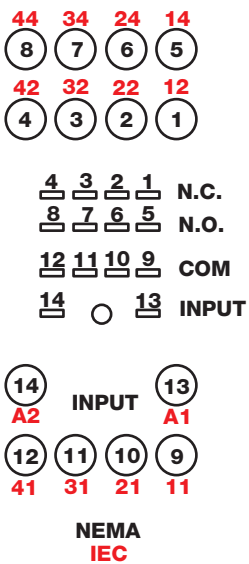

RXZE2S114S

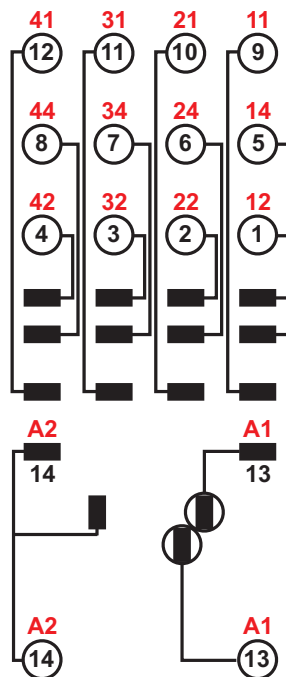





**Schneider Electric USA, Inc.**

8001 Knightdale Blvd.  
Knightdale, NC 27545  
Tel: 888-778-2733  
[www.schneider-electric.com](http://www.schneider-electric.com)

Electrical equipment should be installed, operated, serviced, and maintained only by qualified personnel. No responsibility is assumed by Schneider Electric for any consequences arising out of the use of this material.

© 2014 Schneider Electric. All Rights Reserved.

Schneider Electric and Square D are trademarks owned by Schneider Electric Industries SAS or its affiliated companies. All other trademarks are the property of their respective owners.

8501CT1407, 09/2014

Replaces 8501CT0301R07/08, 08/2008