

GV2, GV3, and GV7

Manual Motor Starters, Controllers, and Protectors

Catalog
2520CT0001R04/09
2010
Class 2520



Table of Contents

INTRODUCTION	5
STANDARD FEATURES	5
SHORT-CIRCUIT CURRENT RATINGS	7
UL 508 Type E	7
UL 508 Type F	8
UL 508 Group Motor Installations	9
SPECIFICATIONS AND OPERATING CURVES	10
GV2 Specifications	10
GV2 Operating Curves	15
GV3 Specifications	21
GV3 Auxiliary Contact Specifications	23
GV3 Operating Curves	24
GV7 Specifications	27
GV7 Auxiliary Contact Specifications	29
GV7 Operating Curves	30
SELECTION.....	37
Fuse and Circuit Breaker Selection	37
GV2 and GV3 Selection	38
GV7 Selection	39
GV2 and GV3 Accessories	40
GV7 Accessories	49
MOUNTING DIMENSIONS AND WIRING DIAGRAMS	54
GV2 Mounting Dimensions	54
GV3 Mounting Dimensions	58
GV7 Mounting Dimensions	59
GV2 Wiring Diagrams	62

GV2, GV3, and GV7 Manual Motor Starters, Controllers, and Protectors

Introduction

Schneider Electric offers a complete line of products for the manual control and protection of motors. This catalog covers those devices designed to meet IEC standards for protection and control.¹

The GV2 and GV3 manual starters and protectors provide manual isolation, manual motor control, and overcurrent protection in one compact unit. Schneider Electric offers four different products that make up the GV product family:

- The GV2ME manual starter controls motors with full-load currents up to 32 A.
- The GV2P high-performance manual starter offers a higher withstand rating and visible trip indication.
- The GV3P controls larger motors with full-load currents up to 65 A.
- The GV7 controls and protects motors with full-load currents up to 220 A.

These devices are UL Listed as manual motor controllers. The GV2 and GV3 manual starters and protectors are also UL Listed for group installation applications.

In many European applications, the GV devices are used as motor circuit breakers because they meet the requirements of IEC 60947-2 for motor circuit breakers. However, the GV starter does not meet North American circuit breaker standards, such as those of UL, the National Electrical Code (NEC), or CSA.

Standard Features

The GV family standard features include the following:

- UL 508 Listed, IEC/EN 60947-1, 60947-2, 60947-4-1, CSA C 22.2 n° 14-05 type ECSA Certified, and CE Marked
- UL Listed for group motor applications (for more details, see page 9)
- Overload relay
 - Class 10, ambient-compensated, bimetallic (GV2, GV3)
 - Class 10, solid state (GV7)
- Single-phase sensitivity
- Magnetic, instantaneous short-circuit protection
- Test-trip mechanism
- Provision for padlocking in the Off position
 - Standard for GV2, GV3
 - Requires an attachment for GV7 (see Table 66 on page 53)
- Finger-safe terminals meet IP20 standards and IEC 60529
- North American and European terminal markings







¹ Related catalogs cover the products used in conjunction with manual motor protectors:
IEC Style Contactors and Starters, catalog number 8502CT9901R9/02.
Wiring, Communication and Busbar System, catalog number 8502CT0101.
Manual Starters and Switches, catalog number 2510CT9701.

GV2, GV3, and GV7 Manual Motor Starters, Controllers, and Protectors

Standard Features

Table 1: Standard Features

	 GV2ME 0.1 to 32 A Up to 20 hp @ 460 V 10 kA SCCR @ 480 V Push Button Operator	 GV2P 0.1 to 30 A Up to 15 hp @ 460 V 50 kA SCCR @ 480 V Rotary Handle Operator Visible Trip Indication	 GV3P 9 to 65 A Up to 40 hp @ 460 V GV3P13–GV3P32 rated 100 kA SCCR @ 480 V GV3P40–GV3P65 rated 65 kA SCCR @ 480 V Rotary Handle	 GV7RE/GV7RS 25 to 220 A Up to 150 hp @ 460 V 25 kA SCCR @ 480 V Toggle Operator
Protection	Thermal-magnetic (overload relays are bimetallic—Class 10)			Solid-state overload relay—magnetic short circuit (Class 10)
Mounting	<ul style="list-style-type: none"> Clip-on mounting on 35 mm DIN rail. Unclips without the use of a tool. Panel mounts using a metal adapter plate. 	<ul style="list-style-type: none"> Clip-on mounting on 35 mm DIN rail. Unclips without the use of a tool. Panel mounts directly. 	<ul style="list-style-type: none"> Clip-on mounting on 35 mm DIN rail. Unclips without the use of a tool. Panel mounts directly. 	Panel mounts directly
Connection	Screw terminals using cross-head, captive screws. Cross-head screws used for connections on GV2 starters and their add-on blocks.		Uses an Allen wrench.	Clip-on connectors (sold separately)
Marking	Using the marker holder supplied with each unit.			
Trip test	Using a fine-blade screwdriver on the front face of the product.			—
Signaling on the front face				
Manual control device	On or Off state	<ul style="list-style-type: none"> On or Off state Trip on overload, short circuit, undervoltage, or shunt trip. 	<ul style="list-style-type: none"> On or Off state Trip on overload, short circuit, undervoltage, or shunt trip. 	On or Off state
Mechanical flag indicator	—	Trips on short circuit	Trips on short circuit	Trip on overload or short circuit
Padlocking	Padlocks in the Off position using the system incorporated into the manual control device. (Padlocks are supplied by the customer.)			Padlockable when used with a door-mounted rotary handle or with a separate locking device
Tamper-proof current dial	—	The thermal-current setting dial is covered by a transparent cover, which can be sealed.	—	—
Accessories				
Front-mounting accessories	Instantaneous contact blocks—either N.C., N.O., N.O. + N.O., or N.O. + N.C.—which do not increase the width of the product.			Front accessible, internally mounted:
Side-mounting accessories (snap onto the starters without the use of a tool)	On the left side, contact blocks which provide the following: <ul style="list-style-type: none"> N.O. + N.O. or N.O. + N.C. instantaneous contacts N.O. or N.C. trip signaling contact incorporating a mechanical flag indicator and an N.O. or N.C. instantaneous contact C/O magnetic trip signaling contact, associated with a mechanical flag indicator, used for reset. On the right side: <ul style="list-style-type: none"> Shunt trip or undervoltage trip 			<ul style="list-style-type: none"> Auxiliary contacts Trip indication contacts Shunt trip Undervoltage trip Rotary Handles
Other accessories	<ul style="list-style-type: none"> Combination block for use with TeSys® contactor Bus bars and connectors 	<ul style="list-style-type: none"> Visible isolation block, mounting on the incoming terminals of the device Door interlock mechanism 	—	
Selection	Page 38	Page 38	Page 38	Page 39

GV2, GV3, and GV7 Manual Motor Starters, Controllers, and Protectors Short-Circuit Current Ratings

Short-Circuit Current Ratings

UL 508 Type E

Manual Self-Protected Combination Motor Controller, TeSys® GV

Manual Self-Protected Combination Starter Meeting UL 508 Type E, UL File E164871

Table 2: TeSys GV2P Horsepower and SCCR Ratings

In combination with line spacer GV2GH7 (stand-alone starters) or GV1G09 terminal and GV2G busbars (multiple starters)

Standard Motor Ratings @ 50/60 Hz (hp)						Associated Cable, AWG 75 °C, Cu	Manual Self-Protected Starter	Overload Trip Range (A)	SCCR (kA) 480Y/277V
1 Ø		3 Ø							
120 V	240 V	200 V	240 V	480 V	600 V				
						10	GV2P01	0.1–0.16	100
						10	GV2P02	0.16–0.25	100
						10	GV2P03	0.25–0.4	100
						10	GV2P04	0.4–0.63	100
				0.5		10	GV2P05	0.63–1	100
				0.75		10	GV2P06	1–1.6	100
		0.5	0.5	1		10	GV2P07	1.6–2.5	100
		0.75	1	2		10	GV2P08	2.5–4	100
		1.5	1.5	4		10	GV2P10	4–6.3	100
0.5	1	2	3	5	7.5	10	GV2P14	6–10	100
1	2	3	3	10	10	8	GV2P16	9–14	10
1	3	5	5	10	15	8	GV2P20	13–18	10
2	3	5	7.5	15	20	6	GV2P21	17–23	10
2	3	5	7.5	15	20	6	GV2P22	20–25	10

Table 3: TeSys GV3P Horsepower and SCCR Ratings

In combination with line spacer GV3G66 and magnetic trip unit GVAM11 for stand-alone starters

Standard Motor Ratings @ 50/60 Hz (hp)						Associated Cable, AWG 75 °C, Cu	Manual Self-Protected Starter	Overload Trip Range (A)	SCCR (kA)	
1 Ø		3 Ø							480Y/277 V	600Y/347 V
120 V	240 V	200 V	240 V	480 V	600 V					
1	2	3	3	7.5	10	8	GV3P13	9–13	100	25
1	3	3	5	7.5	10	8	GV3P18	12–18	100	25
2	3	5	7.5	15	20	6	GV3P25	17–25	100	25
2	3	7.5	7.5	20	25	6	GV3P32	23–32	100	25
3	5	10	10	25	30	3	GV3P40	30–40	65	25
3	7.5	10	10	30	40	3	GV3P50	37–50	65	25
5	10	15	15	40	50	3	GV3P65	48–65	65	25

GV2, GV3, and GV7 Manual Motor Starters, Controllers, and Protectors

Short-Circuit Current Ratings

UL 508 Type F

Combination Motor Controller, TeSys® GV

Manual Self-Protected Combination Starter Meeting UL 508 Type F, UL File E164871

Table 4: TeSys GV2P Horsepower and SCCR Ratings

In combination with line spacer GV2GH7 (stand-alone starters) or GV1G09 terminal and GV2G busbars (multiple starters)

Standard Motor Ratings @ 50/60 Hz (hp)						Associated Cable, AWG 75 °C, Cu	Manual Self-Protected Starter	Overload Trip Range (A)	Type of Contactor Required	SCCR (kA) 480Y/277 V
1 Ø		3 Ø								
120 V	240 V	200 V	240 V	480 V	600 V					
						10	GV2P01	0.1–0.16	LC1D09 or D12	100
						10	GV2P02	0.16–0.25	LC1D09 or D12	100
						10	GV2P03	0.25–0.4	LC1D09 or D12	100
						10	GV2P04	0.4–0.63	LC1D09 or D12	100
				0.5		10	GV2P05	0.63– 1	LC1D09 or D12	100
				0.75		10	GV2P06	1–1.6	LC1D09 or D12	100
		0.5	0.5	1		10	GV2P07	1.6–2.5	LC1D09 or D12	100
		0.75	1	2		10	GV2P08	2.5– 4	LC1D09 or D12	100
		1.5	1.5	4		10	GV2P10	4–6.3	LC1D09 or D12	100
0.5	1	2	3	5	7.5	10	GV2P14	6–10	LC1D09 or D12	100
1	2	3	3	10	10	8	GV2P16	9–14	LC1D12 or D18	42
1	3	5	5	10	15	8	GV2P20	13–18	LC1D12 or D18	42
2	3	5	7.5	15	20	6	GV2P21	17–23	LC1D25 or D32	42
2	3	5	7.5	15	20	6	GV2P22	20–25	LC1D25 or D32	42

Table 5: TeSys GV3P Horsepower and SCCR Ratings

In combination with line spacer GV3G66 and magnetic trip unit GVAM11 for stand-alone starters

Standard Motor Ratings @ 50/60 Hz (hp)						Associated Cable, AWG 75 °C, Cu	Manual Self-Protected Starter	Overload Trip Range (A)	Type of Contactor Required	SCCR (kA)	
1 Ø		3 Ø								480Y/ 277 V	600Y/ 347 V
120 V	240 V	200 V	240 V	480 V	600 V						
1	2	3	3	7.5	10	8	GV3P13	9–13	LC1D18	65	25
1	3	3	5	7.5	10	8	GV3P18	12–18	LC1D18	65	25
2	3	5	7.5	15	20	6	GV3P25	17–25	LC1D25	65	25
2	3	7.5	7.5	20	25	6	GV3P32	23–32	LC1D32	65	25
3	5	10	10	25	30	3	GV3P40	30–40	LC1D40A/ 50A/65A	65	25
3	7.5	10	10	30	40	3	GV3P50	37–50	LC1D50A/65A	65	25
5	10	15	15	40	50	3	GV3P65	48–65	LC1D65A/80	65	25

GV2, GV3, and GV7 Manual Motor Starters, Controllers, and Protectors Short-Circuit Current Ratings

UL 508 Group Motor Installations

Manual Combination Motor Controller, TeSys® GV
GV2ME: UL File E164864
(MC 164581, Report 1012350, Project 2152063)

Table 6: TeSys GV2ME Horsepower and SCCR Ratings

In association with LC1D contactors, suitable for group installation when protected by fuses or an inverse-time circuit breaker (when used with GV1G09 terminal or GV2G05 blocks plus GV2G busbars)

Standard Motor Ratings @ 50/60 Hz (hp)						Associated Cable, AWG 75 °C, Cu	Manual Motor Starter	Overload Trip Range (A)	Contactor	SCCR (kA)				
1 Ø		3 Ø								240/480 V	600Y/347 V	480 V with GV1L3 Limiter	Contactor	600 V with LA9LB920 Limiter
120 V	240 V	200 V	240 V	480 V	600 V									
						10	GV2ME01	0.1–0.16	LC1D09 or D12	65	42	65	LC1D09 or D12	42
						10	GV2ME02	0.16–0.25	LC1D09 or D12	65	42	65	LC1D09 or D12	42
						10	GV2ME03	0.25–0.4	LC1D09 or D12	65	42	65	LC1D09 or D12	42
						10	GV2ME04	0.4–0.63	LC1D09 or D12	65	42	65	LC1D09 or D12	42
				0.5		10	GV2ME05	0.63–1	LC1D09 or D12	65	42	65	LC1D09 or D12	42
				0.75		10	GV2ME06	1–1.6	LC1D09 or D12	65	42	65	LC1D09 or D12	42
		0.5	0.5	1		10	GV2ME07	1.6–2.5	LC1D09 or D12	65	42	65	LC1D09 or D12	42
		0.75	1	2		10	GV2ME08	2.5–4	LC1D09 or D12	65	42	65	LC1D09 or D12	42
		1.5	1.5	4		10	GV2ME10	4–6.3	LC1D09 or D12	65	42	65	LC1D09 or D12	42
0.5	1	2	3	5	7.5	10	GV2ME14	6–10	LC1D09 or D12	65	42	65	LC1D09 or D12	42
1	2	3	3	10	10	8	GV2ME16	9–14	LC1D12 or D18	22	10	65	LC1D32 or D38	42
1	3	5	5	10	15	8	GV2ME20	13–18	LC1D12 or D18	22	10	65	LC1D32 or D38	42
2	3	5	7.5	15	20	6	GV2ME21	17–23	LC1D25 or D32	10	10	65	LC1D32 or D38	42
2	3	5	7.5	15	20	6	GV2ME22	20–25	LC1D25 or D32	10	10	65	LC1D32 or D38	42
2	5	10	10	20	30	6	GV2ME32	24–32	LC1D25 or D32	5	5	65	LC1D32 or D38	42

GV2, GV3, and GV7 Manual Motor Starters, Controllers, and Protectors

Specifications and Operating Curves

Specifications and Operating Curves

GV2 Specifications

Table 7: Environment

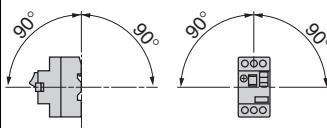
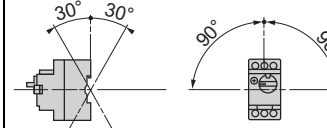
Type	GV2ME	GV2P	LS1D30, LS1D303	LS1D32, LS1D323		
Conforming to standards	IEC 60947-1, 60947-2, 60947-4-1, EN 60204, BS 4752, BS 4941, UL 508, CSA C22.2 No. 14, NF C 63-650, NFC63-120, 79-130, VDE 0113, 0660.					
Product approvals	DEMKO, NEMKO, SEMKO, CSA, UL, BV, GL, LROS, DNV, PTB	CSA, UL, PTB	UL, CSA	BV		
UL File Number	File E164864, CCN NLRV		File E197164 CCN IZLT	File E197164 CCN IZLT2		
CSA File Number	File LR 81630, Class 3211 05		File 222370, Class 6225-01			
Protective treatment	—	—	"TH"	"TH"		
Degree of protection Conforming to IEC 60529	GV2ME01 enclosure: IP41 GV2ME02 enclosure: IP55	—	—	—		
Shock resistance Conforming to IEC 60068-2-27	30 g	30 g	—	—		
Vibration resistance Conforming to IEC 60068-2-6	5 to 150 Hz (5 g)	5 to 150 Hz (5 g)	—	—		
Ambient air temperature						
Storage	-40 to +176 °F (-40 to +80 °C)	-40 to +176 °F (-40 to +80 °C)	—	—		
Operation	Open: -4 to +140 °F (-20 to +60 °C) Enclosed: -4 to 104 °F (-20 to 40 °C)	-4 to +140 °F (-20 to +60 °C)	-58 to +158 °F (-50 to +70 °C)	-58 to +158 °F (-50 to +70 °C)		
Temperature compensation	Open: -4 to +140 °F (-20 to +60 °C) Enclosed: -4 to 104 °F (-20 to 40 °C)	-4 to +140 °F (-20 to +60 °C)	—	—		
Flame resistance Conforming to IEC 60695-2-1	1760 °F (960 °C)					
Maximum operating altitude	6562 ft (2000 m)	6562 ft (2000 m)	—	—		
Operating positions in relation to the normal vertical mounting position					± 23 °	
Wiring Number of conductors and wire size	Maximum	Minimum	Maximum	Minimum	Maximum	Minimum
Solid cable	2 x 8 AWG (2 x 6 mm ²)	2 x 16 AWG (2 x 1 mm ²)	2 x 8 AWG (2 x 6 mm ²)	2 x 16 AWG (2 x 1 mm ²)	2 x 8 AWG (2 x 6 mm ²)	2 x 16 AWG (2 x 1 mm ²)
Flexible cable without cable end	2 x 8 AWG (2 x 6 mm ²)	2 x 14 AWG (2 x 1 mm ²)	2 x 8 AWG (2 x 6 mm ²)	2 x 14 AWG (2 x 1 mm ²)	2 x 8 AWG (2 x 6 mm ²)	2 x 14 AWG (2 x 1 mm ²)
Flexible cable with cable end	2 x 10 AWG (2 x 4 mm ²)	2 x 16 AWG (2 x 1 mm ²)	2 x 10 AWG (2 x 4 mm ²)	2 x 16 AWG (2 x 1 mm ²)	2 x 10 AWG (2 x 4 mm ²)	2 x 16 AWG (2 x 1 mm ²)
Suitable for isolation Conforming to IEC 60947-1 / 60947-1-6	Yes		Yes		—	—
Tightening torque	15 lb-in (1.7 N·m)					
Resistance to mechanical impact	0.5 J		0.5 J			
Sensitivity to phase failure	Conforming to IEC 60947-4-1, paragraph 7-2-1-5-2			—	—	

GV2, GV3, and GV7 Manual Motor Starters, Controllers, and Protectors Specifications and Operating Curves

Table 8: Technical Characteristics

Type		GV2ME	GV2P	LS1D30, LS1D303	LS1D32, LS1D323 ^[1]
Utilization category	Conforming to IEC 60947-2	A	A	—	AC 20B#
	Conforming to IEC 60947-4-1	AC-3	AC-3		
Rated operational voltage (Ue)	Conforming to IEC 60947-2	690 V	690 V	690 V	690 V
Rated insulation voltage (Ui)	Conforming to IEC 60947-2	690 V	690 V	—	690 V
	Conforming to CSA C22.2 No. 14 and UL 508	600 V	600 V		
Rated operational frequency	Conforming to IEC 60947-2	50/60 Hz	50/60 Hz	50/60 Hz	50/60 Hz
Rated impulse withstand voltage (U imp)	Conforming to IEC 60947-2	6 kV	6 kV	—	—
Total power dissipated per pole (W)		2.5 W	2.5 W	3.2 W	3.2 W
Mechanical life (close-open operations) (varies with conditions)		100,000	—	—	—
Electrical life (close-open operations) (for AC-3 duty)		100,000	100,000	—	—
Duty class (close-open operations/hr) (maximum operating rate)		25	25	—	—
Rated duty	Conforming to IEC 60947-4-1	—	Continuous duty	—	—

¹ Conforming to IEC 60947-3

Table 9: GV2 Trip Module Specifications

Type		GV2AU	GV2AS
Rated insulation voltage (Ui)	Conforming to IEC 60947-1	690 V	690 V
Operational voltage (Ue)	Conforming to IEC 60947-1	0.85-1.1 V	0.7-1.1 V
Drop-out voltage (Ue)		0.35-0.7 V	0.2-0.75 V
Inrush consumption		12 VA	14 VA
		8 W	10.5 W
Sealed consumption		3.5 VA	5 VA
		1.1 W	1.6 W
Operating time (ms)	Conforming to IEC 60947-1	From the moment the voltage reaches its operational value until opening of the GV2•• 10–15 ms	
On-load factor		100%	
Wiring		Minimum	Maximum
Number of conductors and wire size	Solid cable	1 x 16–12 AWG (1-2.5 mm ²)	2 x 16–12 AWG (1–2.5 mm ²)
	Flexible cable <i>without</i> cable end	1 x 18–12 AWG (0.75-2.5 mm ²)	2 x 18–12 AWG (0.75–2.5 mm ²)
	Flexible cable <i>with</i> cable end	1 x 18–14 AWG (0.75-1.5 mm ²)	2 x 18–14 AWG (0.75–1.5 mm ²)
Tightening torque		12 lb-in (1.4 N•m) maximum	

GV2, GV3, and GV7 Manual Motor Starters, Controllers, and Protectors

Specifications and Operating Curves

Table 10: GV Auxiliary and Fault Signaling Contact Specifications

Type	Instantaneous Auxiliary Contacts GVAN, GVAD							Fault Signaling Contacts GV2AD, GV2AM11			
Rated insulation voltage (Ui) (associated insulation coordination) Conforming to IEC 60947-1	690 V							690 V			
Conforming to CSA C22.2 No. 14 and UL 508	600 V							300 V			
Conventional rated thermal current (Ith) Conforming to IEC 60947-5-1	6 A							2.5 A			
Conforming to CSA C22.2 No. 14 and UL 508	5 A							1 A			
Operational power and current— AC operation Conforming to IEC 60947-5-1	AC-15/100,000 close–open operations							AC-14/1000 close–open operations			
Rated operational voltage (Ue)	48 V	110 V 127 V	230 V 240 V	380 V 415 V	440 V	500 V	690 V	24 V	48 V	110 V 127 V	230 V 240 V
Operational power, normal conditions	300 VA	500 VA	720 VA	850 VA	650 VA	500 VA	400 VA	36 VA	48 VA	72 VA	72 VA
Occasional breaking and making capacities, abnormal conditions	3000 VA	7000 VA	13,000 VA	15,000 VA	13,000 VA	12,000 VA	9000 VA	220 VA	300 VA	450 VA	450 VA
Rated operational current (Ie)	6 A	4.5 A	3.3 A	2.2 A	1.5 A	1 A	0.6 A	1.5 A	1 A	0.5 A	0.3 A
Operational power and current— DC operation Conforming to IEC 60947-5-1	DC-13/100,000 close–open operations							DC-13/1000 close–open operations			
Rated operational voltage (Ue)	24 V	48 V	60 V	110 V	240 V ^[1]	—	—	24 V	48 V	60 V	—
Operational power, normal conditions	140 W	240 W	180 W	140 W	120 W	—	—	24 W	15 W	9 W	—
Occasional breaking and making capacities, abnormal conditions	240 W	360 W	240 W	210 W	180 W	—	—	100 W	50 W	50 W	—
Rated operational current (Ie)	6 A	5 A	3 A	1.3 A	0.5 A	—	—	1 A	0.3 A	0.15 A	—
Low-level switching contact reliability	Number of faults for <i>n</i> million operating cycles (17 V, 5 mA): = 10 ⁻⁶										
Short-circuit protection	GB2CB** control circuit protector or control circuit fuse gG 10 A maximum (or equivalent).										
Wiring (screw clamp)	Minimum							Maximum			
Number of conductors and wire size											
Solid cable	1 x 16–12 AWG (1–2.5 mm ²)							2 x 16–12 AWG (1–2.5 mm ²)			
Flexible cable <i>without</i> cable end	1 x 18–12 AWG (0.75–2.5 mm ²)							2 x 18–12 AWG (0.75–2.5 mm ²)			
Flexible cable <i>with</i> cable end	1 x 18–14 AWG (0.75–1.5 mm ²)							2 x 18–14 AWG (0.75–1.5 mm ²)			
Wiring (spring terminal)	Minimum (GVAN only)							Maximum (GVAN only)			
Flexible cable <i>without</i> cable end	1 x 18–12 AWG (0.75–2.5 mm ²)							2 x 18–12 AWG (0.75–2.5 mm ²)			
Tightening torque	12 lb-in (1.4 N•m) maximum										

¹ Add an RC circuit, Type LA4D, to the load terminals. Consult the *Digest*.

GV2, GV3, and GV7 Manual Motor Starters, Controllers, and Protectors Specifications and Operating Curves

Table 11: GV2AE Auxiliary Contact Specifications

Type	Instantaneous Auxiliary Contacts GV2AE																																																																											
Rated insulation voltage (Ui) (associated insulation coordination) Conforming to IEC 60947-1	250 V (690 V with respect to main circuit)																																																																											
Conforming to CSA C22.2 No. 14 and UL 508	300 V																																																																											
Conventional rated thermal current (Ith) Conforming to IEC 60947-5-1	2.5 A																																																																											
Conforming to CSA C22.2 No. 14 and UL 508	1 A																																																																											
Operational power and current AC operation Conforming to IEC 60947-5-1	AC-15/100,000 close–open operations																																																																											
Rated operational voltage (Ue)	24 V	48 V	110 V 127 V	230 V 240 V																																																																								
Operational power, normal conditions	48 VA	60 VA	120 VA	120 VA																																																																								
Occasional breaking and making capacities, abnormal conditions	480 VA	600 VA	1270 VA	2400 VA																																																																								
Rated operational current (Ie)	2 A	1.25 A	1 A	0.5 A																																																																								
Operational power and current DC operation Conforming to IEC 60947-5-1	DC-13/100,000 close–open operations																																																																											
Rated operational voltage (Ue)	24 V	48 V	60 V	—																																																																								
Operational power, normal conditions	24 W	15 W	9 W	—																																																																								
Occasional breaking and making capacities, abnormal conditions	100 W	50 W	50 W	—																																																																								
Rated operational current (Ie)	1 A	0.3 A	0.15 A	—																																																																								
Low-level switching contact reliability	Number of faults for <i>n</i> million operating cycles (17 V, 5 mA): = 10 ⁻⁶																																																																											
Short-circuit protection	GB2CB ** control circuit protector or control circuit fuse gG 10 A maximum (or equivalent).																																																																											
Wiring (screw clamp)	Minimum		Maximum																																																																									
Number of conductors and wire size																																																																												
Solid cable	1 x 16–12 AWG (1–2.5 mm ²)		2 x 16–12 AWG (1–2.5 mm ²)																																																																									
Flexible cable <i>without</i> cable end	1 x 18–12 AWG (0.75–2.5 mm ²)		2 x 18–12 AWG (0.75–2.5 mm ²)																																																																									
Flexible cable <i>with</i> cable end	1 x 18–14 AWG (0.75–1.5 mm ²)		2 x 18–14 AWG (0.75–1.5 mm ²)																																																																									
Wiring (spring terminal)	Minimum (GVAN only)		Maximum																																																																									
Flexible cable <i>without</i> cable end	1 x 18–12 AWG (0.75–2.5 mm ²)		2 x 18–12 AWG (0.75–2.5 mm ²)																																																																									
Tightening torque	12 lb-in (1.4 N•m) maximum																																																																											
Contact operation instantaneous auxiliary contacts	<div style="display: flex; align-items: flex-start;"> <div style="flex: 1;"> <p style="text-align: center;">Power Pole 0 1</p> <table style="width: 100%; border-collapse: collapse;"> <tr> <td style="width: 10%;"></td> <td style="width: 10%; text-align: center;">0</td> <td style="width: 10%; text-align: center;">1</td> <td style="width: 10%;"></td> <td style="width: 10%;"></td> <td style="width: 10%;"></td> <td style="width: 10%;"></td> <td style="width: 10%;"></td> </tr> <tr> <td></td> <td style="text-align: center;">N.O.</td> <td style="text-align: center;">N.O.</td> <td style="text-align: center;">N.O.</td> <td style="text-align: center;">N.C.</td> <td style="text-align: center;">N.O.</td> <td style="text-align: center;">N.O.</td> <td style="text-align: center;">N.C.</td> </tr> <tr> <td>GVAN20</td> <td style="text-align: center;">N.O.</td> <td style="text-align: center;">N.O.</td> <td style="text-align: center;">N.O.</td> <td style="text-align: center;">N.C.</td> <td style="text-align: center;">N.O.</td> <td style="text-align: center;">N.O.</td> <td style="text-align: center;">N.C.</td> </tr> <tr> <td>GVAN11</td> <td style="text-align: center;">N.O.</td> <td style="text-align: center;">N.C.</td> <td style="text-align: center;">N.O.</td> <td style="text-align: center;">N.C.</td> <td style="text-align: center;">N.O.</td> <td style="text-align: center;">N.O.</td> <td style="text-align: center;">N.C.</td> </tr> <tr> <td>GVAE1</td> <td style="text-align: center;">N.O.</td> <td style="text-align: center;">N.C.</td> <td style="text-align: center;">N.O.</td> <td style="text-align: center;">N.C.</td> <td style="text-align: center;">N.O.</td> <td style="text-align: center;">N.O.</td> <td style="text-align: center;">N.C.</td> </tr> <tr> <td>GVAE20</td> <td style="text-align: center;">N.O.</td> <td style="text-align: center;">N.O.</td> <td style="text-align: center;">N.O.</td> <td style="text-align: center;">N.C.</td> <td style="text-align: center;">N.O.</td> <td style="text-align: center;">N.O.</td> <td style="text-align: center;">N.C.</td> </tr> <tr> <td>GVAE11</td> <td style="text-align: center;">N.O.</td> <td style="text-align: center;">N.C.</td> <td style="text-align: center;">N.O.</td> <td style="text-align: center;">N.C.</td> <td style="text-align: center;">N.O.</td> <td style="text-align: center;">N.O.</td> <td style="text-align: center;">N.C.</td> </tr> <tr> <td>GVAD**10</td> <td style="text-align: center;">N.O.</td> <td style="text-align: center;">N.O.</td> <td style="text-align: center;">N.O.</td> <td style="text-align: center;">N.C.</td> <td style="text-align: center;">N.O.</td> <td style="text-align: center;">N.O.</td> <td style="text-align: center;">N.C.</td> </tr> <tr> <td>GVAD**01</td> <td style="text-align: center;">N.C.</td> <td style="text-align: center;">N.O.</td> <td style="text-align: center;">N.O.</td> <td style="text-align: center;">N.C.</td> <td style="text-align: center;">N.O.</td> <td style="text-align: center;">N.O.</td> <td style="text-align: center;">N.C.</td> </tr> </table> </div> <div style="flex: 1; padding-left: 10px;"> <p>□ Contact Open</p> <p>■ Contact Closed</p> <p>Operation of fault signaling contacts</p> <p>GV2AM11 Change of state following trip on short circuit.</p> <p>GV2AD10 and AD01 Change of state following trip on short circuit, overload or undervoltage.</p> </div> </div>					0	1							N.O.	N.O.	N.O.	N.C.	N.O.	N.O.	N.C.	GVAN20	N.O.	N.O.	N.O.	N.C.	N.O.	N.O.	N.C.	GVAN11	N.O.	N.C.	N.O.	N.C.	N.O.	N.O.	N.C.	GVAE1	N.O.	N.C.	N.O.	N.C.	N.O.	N.O.	N.C.	GVAE20	N.O.	N.O.	N.O.	N.C.	N.O.	N.O.	N.C.	GVAE11	N.O.	N.C.	N.O.	N.C.	N.O.	N.O.	N.C.	GVAD**10	N.O.	N.O.	N.O.	N.C.	N.O.	N.O.	N.C.	GVAD**01	N.C.	N.O.	N.O.	N.C.	N.O.	N.O.	N.C.
	0	1																																																																										
	N.O.	N.O.	N.O.	N.C.	N.O.	N.O.	N.C.																																																																					
GVAN20	N.O.	N.O.	N.O.	N.C.	N.O.	N.O.	N.C.																																																																					
GVAN11	N.O.	N.C.	N.O.	N.C.	N.O.	N.O.	N.C.																																																																					
GVAE1	N.O.	N.C.	N.O.	N.C.	N.O.	N.O.	N.C.																																																																					
GVAE20	N.O.	N.O.	N.O.	N.C.	N.O.	N.O.	N.C.																																																																					
GVAE11	N.O.	N.C.	N.O.	N.C.	N.O.	N.O.	N.C.																																																																					
GVAD**10	N.O.	N.O.	N.O.	N.C.	N.O.	N.O.	N.C.																																																																					
GVAD**01	N.C.	N.O.	N.O.	N.C.	N.O.	N.O.	N.C.																																																																					

GV2, GV3, and GV7 Manual Motor Starters, Controllers, and Protectors Specifications and Operating Curves

Table 12: GV2 Accessory Specifications

3-Pole Busbars GV2G•		
Rated insulation voltage (Ui)	Conforming to IEC 60947-1	690 V
Conventional rated thermal current (Ith)	Conforming to IEC 60439-1	63 A
Permissible peak current (I peak)		11 kA
Permissible thermal limit (I ² t)		104 kA ² s
Degree of protection	Conforming to IEC 60529	IP20
Terminal Blocks GV2G05 and GV1G09		
Rated insulation voltage (Ui)	Conforming to IEC 60947-1	690 V
Conventional rated thermal current (Ith)	Conforming to IEC 60439-1	63 A
Degree of protection	Conforming to IEC 60529	IP20
Wiring	Solid cable	1 x 14–2 AWG (1.5–25 mm ²) conductor or 2 x 14–6 AWG (1.5–10 mm ²) conductors
	Flexible cable <i>without</i> cable end	1 x 14–2 AWG (1.5–25 mm ²) conductor or 2 x 12–6 AWG (2.5–10 mm ²) conductors
	Flexible cable <i>with</i> cable end	1 x 14–4 AWG (1.5–16 mm ²) conductor or 2 x 14–10 AWG (1.5–4 mm ²) conductors
Tightening torque	Connector	20 lb-in (2.2 N•m)
	Screw clamp	15 lb-in (1.7 N•m)
Current Limiter GV1L3 (European applications only)		
Rated insulation voltage (Ui)	Conforming to IEC 60947-1	690 V
Conventional rated thermal current (Ith)	Conforming to IEC 60947-1	63 A
Operating threshold	rms current	1500 A (non adjustable threshold)
Wiring	Solid cable	1 x 14–2 AWG (1.5–25 mm ²) conductor or 2 x 14–6 AWG (1.5–10 mm ²) conductors
	Flexible cable <i>without</i> cable end	1 x 14–2 AWG (1.5–25 mm ²) conductor or 2 x 12–6 AWG (2.5–10 mm ²) conductors
	Flexible cable <i>with</i> cable end	1 x 14–4 AWG (1.5–16 mm ²) conductor or 2 x 14–10 AWG (1.5–4 mm ²) conductors
Tightening torque		20 lb-in (2.2 N•m)

GV2, GV3, and GV7 Manual Motor Starters, Controllers, and Protectors Specifications and Operating Curves

GV2 Operating Curves

Table 13: Thermal-Magnetic Trip Curves for GV2ME and GV2P

Average operating time at 68 °F (20 °C) as a function of multiples of the setting current

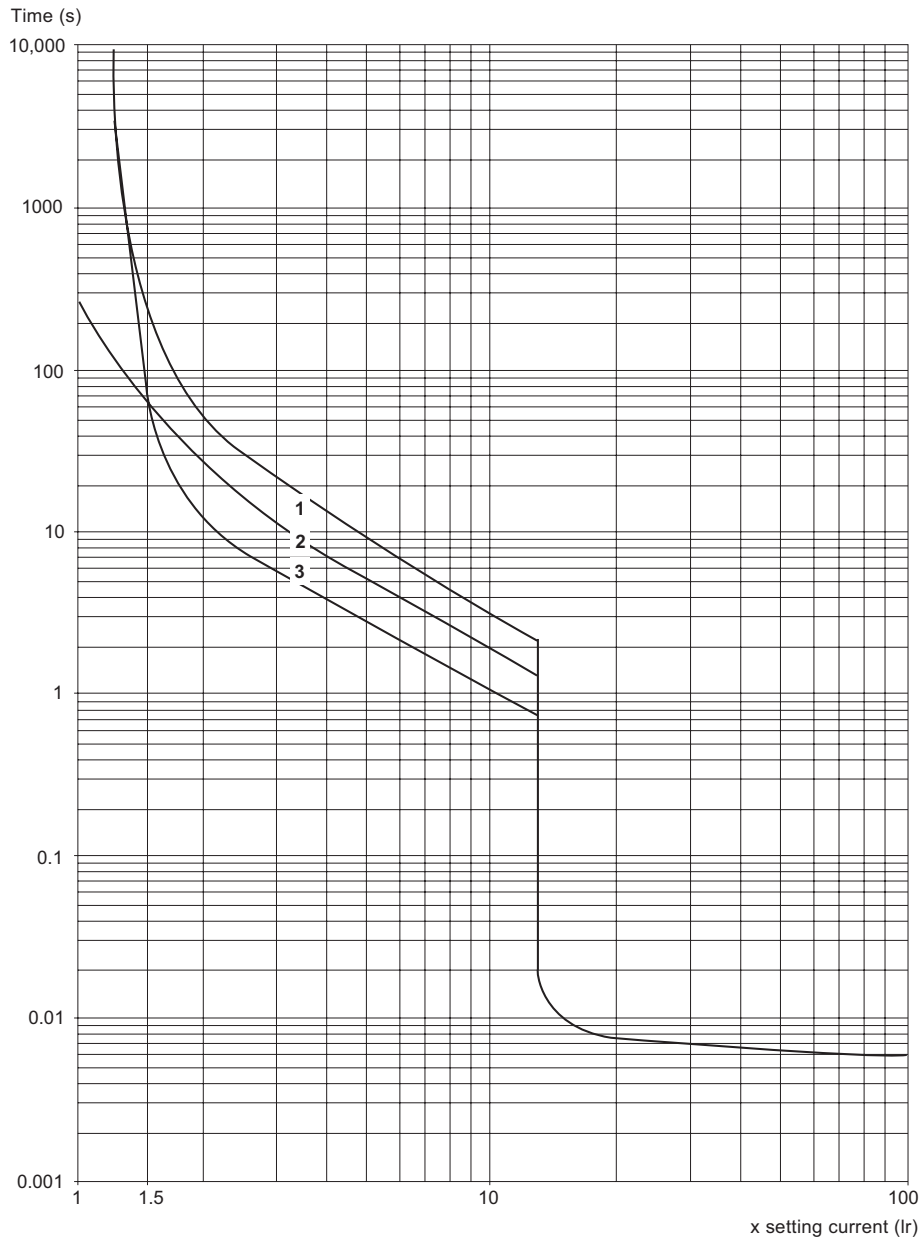

1. 3 poles from cold state
2. 2 poles from cold state
3. 3 poles from hot state

GV2, GV3, and GV7 Manual Motor Starters, Controllers, and Protectors Specifications and Operating Curves

Table 14: Current Limitation on Short Circuit

For GV2M and GV2P
3Ø, 400/415 V

Dynamic stress

1 peak = f (prospective I_{sc}) at 1.05 U_e = 435 V

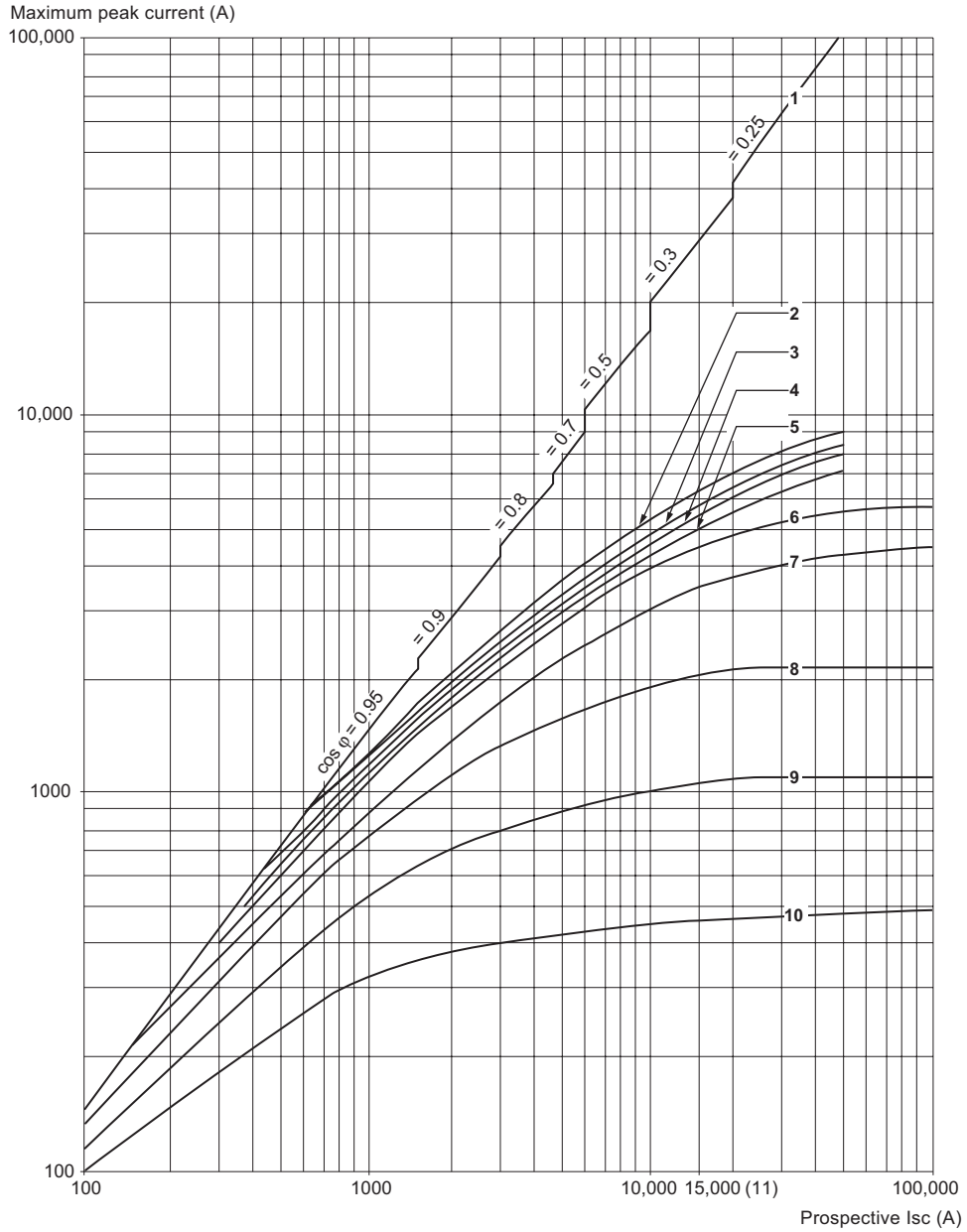

- | | |
|-------------------|---|
| 1. I peak maximum | 7. 4–6.3 A |
| 2. 20–25 A | 8. 2.5–4 A |
| 3. 17–23 A | 9. 1.6–2.5 A |
| 4. 13–18 A | 10. 1–1.6 A |
| 5. 9–14 A | 11. Limit of rated ultimate breaking capacity on short circuit of GV2M (14, 18, 23, and 25 A ratings) |
| 6. 6–10 A | |

GV2, GV3, and GV7 Manual Motor Starters, Controllers, and Protectors Specifications and Operating Curves

Table 15: Thermal Limit on Short Circuit for GV2ME

Thermal limit in kA^2s in the magnetic operating zone
Sum of $I^2dt = f(\text{prospective } I_{sc})$ at $1.05 U_e = 435 V$

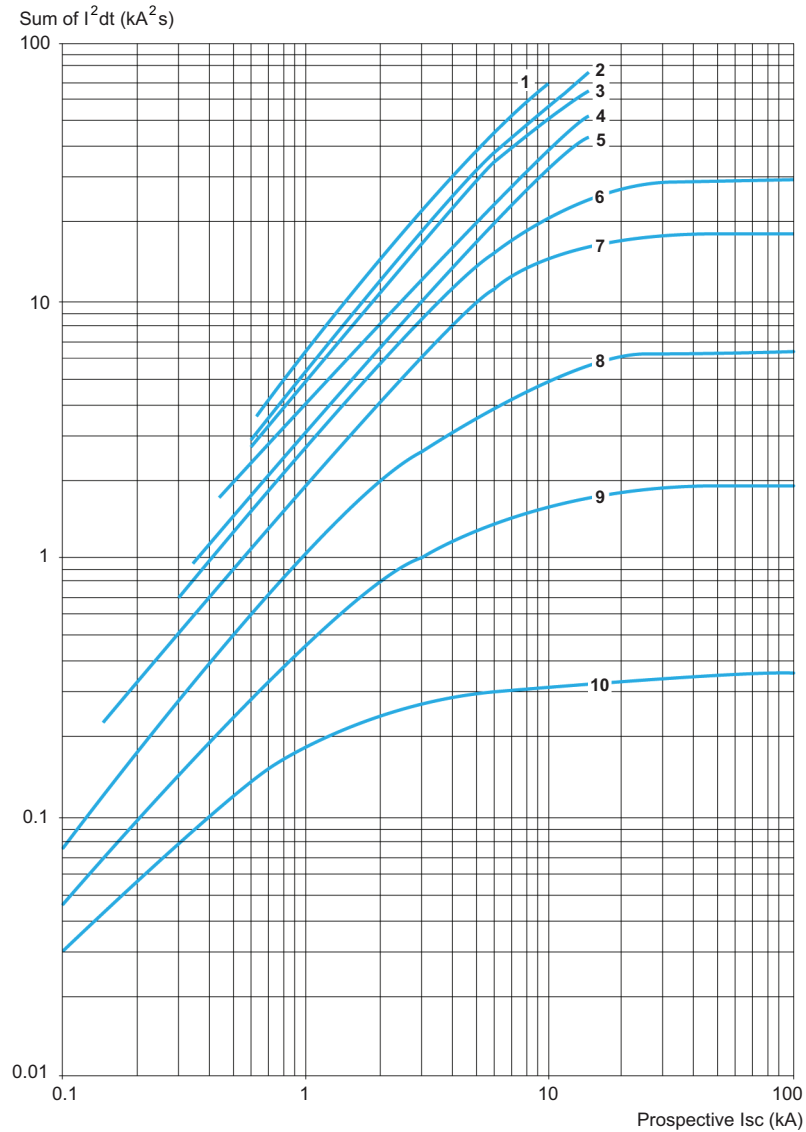

- | | |
|------------|--------------|
| 1. 24–32 A | 6. 6–10 A |
| 2. 20–25 A | 7. 4–6.3 A |
| 3. 17–23 A | 8. 2.5–4 A |
| 4. 13–18 A | 9. 1.6–2.5 A |
| 5. 9–14 A | 10. 1–1.6 A |

GV2, GV3, and GV7 Manual Motor Starters, Controllers, and Protectors Specifications and Operating Curves

Table 16: Thermal Limit on Short Circuit for GV2P

Thermal limit in kA²s in the magnetic operating zone

Sum of I²dt = f (prospective I_{sc}) at 1.05 U_e = 435 V

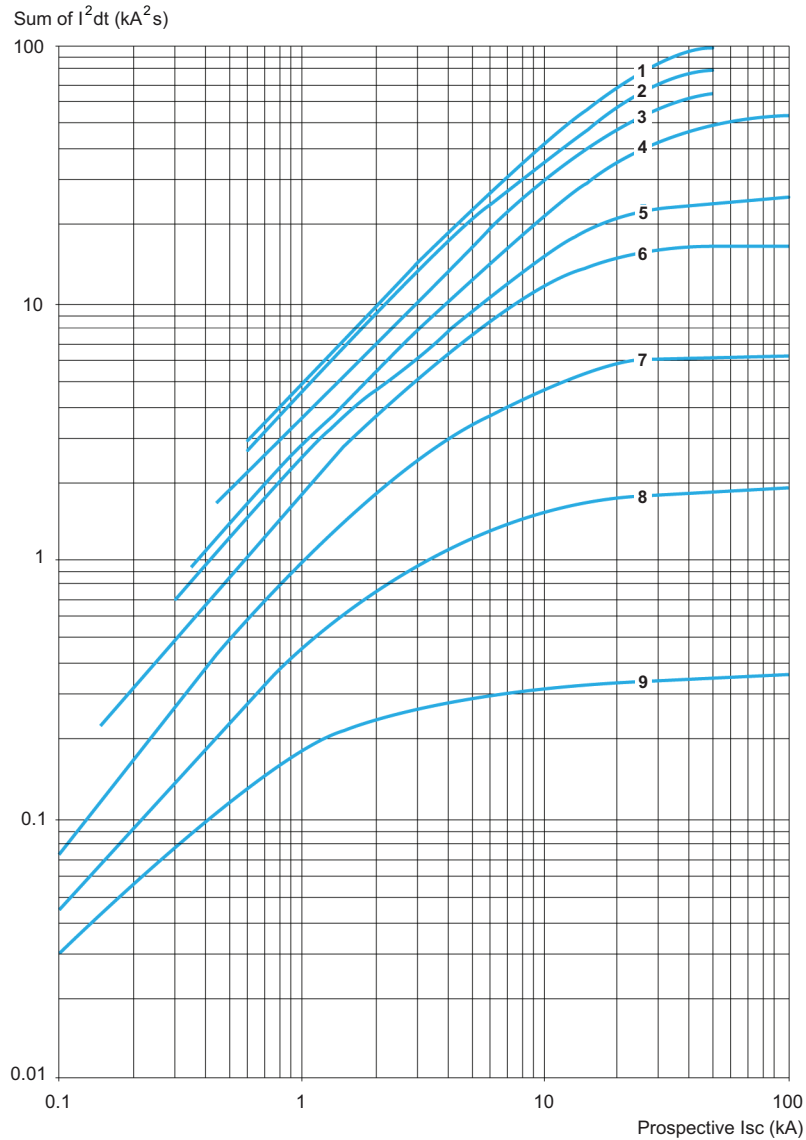

- | | |
|------------|--------------|
| 1. 24–32 A | 6. 6–10 A |
| 2. 20–25 A | 7. 4–6.3 A |
| 3. 17–23 A | 8. 2.5–4 A |
| 4. 13–18 A | 9. 1.6–2.5 A |
| 5. 9–14 A | 10. 1–1.6 A |

GV2, GV3, and GV7 Manual Motor Starters, Controllers, and Protectors Specifications and Operating Curves

Table 17: GV2ME Breaking Capacity for European Applications

Type		Units	Catalog Number Suffix (GV2ME)										
			01-06	07	08	10	14	16	20	21	22		
Rating ^[1]		A	0.1-1.6	2.5	4	6.3	10	14	18	23	25		
Breaking capacity conforming to IEC 60947-2	230/240 V	Icu	kA	>100 kA							50	50	
			%	>100 kA							100	100	
	400/415 V	Icu	kA	>100 kA					15	15	15	15	
			%	>100 kA					50	50	40	40	
	440 V	Icu	kA	>100 kA			50	15	8	8	6	6	
			%	>100 kA			100	100	50	50	50	50	
	500 V	Icu	kA	>100 kA			50	10	6	6	4	4	
			%	>100 kA			100	100	75	75	75	75	
	690 V	Icu	kA	>100 kA	3	3	3	3	3	3	3	3	
			%	>100 kA	75	75	75	75	75	75	75	75	
	Associated fuses (if required) if I _{sc} > breaking capacity I _{cu} conforming to IEC 60947-2	230/240 V	A	Ics	>100 kA							80	80
					>100 kA							100	100
400/415 V		A	Ics	>100 kA					63	63	80	80	
				>100 kA					80	80	100	100	
440 V		A	Ics	>100 kA			50	50	50	50	63	63	
				>100 kA			63	63	63	63	80	80	
500 V		A	Ics	>100 kA			50	50	50	50	50	50	
				>100 kA			63	63	63	63	63	63	
690 V		A	Ics	>100 kA	16	25	32	32	40	40	40	40	
				>100 kA	20	32	40	40	50	50	50	50	

¹ I_{cs} = % of I_{cu}.

Table 18: GV2P Breaking Capacity for European Applications

Type		Units	Catalog Number Suffix (GV2P)										
			01-06	07	08	10	14	16	20	21 & 22	32		
Rating ^[1]		A	0.1-1.6	2.5	4	6.3	10	14	18	23 & 25	32		
Breaking capacity conforming to IEC 60947-2	230/240 V	Ics	kA	>100 kA									
			%	>100 kA									
	400/415 V	Ics	kA	>100 kA					50	50	50		
			%	>100 kA					50	50	50		
	440 V	Ics	kA	>100 kA			50	20	20	20	20		
			%	>100 kA			75	75	75	75			
	500 V	Ics	kA	>100 kA			50	42	10	10	10		
			%	>100 kA			100	75	75	75	75		
	690 V	Ics	kA	>100 kA	8	8	6	6	6	4	4		
			%	>100 kA	100	100	100	100	100	100	100		
	Associated fuses (if required) if I _{sc} > breaking capacity I _{cu} conforming to IEC 60947-2	230/240 V	A	Ics	>100 kA								
					>100 kA							100	100
400/415 V		A	Ics	>100 kA					125	125	125		
				>100 kA					50	63	80	80	
440 V		A	Ics	>100 kA			63	80	100	100			
				>100 kA			50	50	50	50	50		
500 V		A	Ics	>100 kA			63	63	63	63	63		
				>100 kA			50	50	50	50	50		
690 V		A	Ics	>100 kA	20	25	40	40	50	50	50		
				>100 kA	25	32	50	50	63	63	63		

¹ I_{cs} = % of I_{cu}.

GV2, GV3, and GV7 Manual Motor Starters, Controllers, and Protectors Specifications and Operating Curves

Table 19: GV2P Breaking Capacity for European Applications When Used with Current Limiter GV1L3**

Type		Units	Catalog Number Suffix (GV2P**)									
			01-06	07	08	10	14	16	20	21 & 25	32	
Rating ^[1]		A	0.1-1.6	2.5	4	6.3	10	14	18	21 & 23	32	
Breaking capacity conforming to IEC 60947-2	230/240 V	lcs	kA	>100 kA								
			%									
	400/415 V		kA	>100 kA								
			%									
	440 V		kA	>100 kA						100		
			%	>100 kA						50		
	500 V		kA	>100 kA					100			
			%	>100 kA					50			

¹ lcs = % of lcu.

Table 20: GV2ME Breaking Capacity for European Applications When Used with Current Limiter GV1L3**

Type		Units	Catalog Number Suffix (GV2ME**)										
			01 to 06	07	08	10	14	16	20	21	22		
Rating ^[1]		A	0.1-1.6	2.5	4	6.3	10	14	18	23	25		
Breaking capacity conforming to IEC 60947-2	230/240 V	lcs	kA	>100 kA									
			%										
	400/415 V		kA	>100 kA						100	100	100	100
			%	>100 kA						50	50	40	40
	440 V		kA	>100 kA						50	20	20	20
			%	>100 kA						75	75	75	75
	500 V		kA	>100 kA					50	42	10	10	10
			%	>100 kA					100	100	75	75	75
Rating		A	0.1-1.6	2.5	4	6.3	10	14	18	23	25		

¹ lcs = % of lcu.

GV2, GV3, and GV7 Manual Motor Starters, Controllers, and Protectors

Specifications and Operating Curves

GV3 Specifications

Table 21: Environment

Conforming to standards		IEC, NF C, BS, IEC, VDE
Approvals		ASE, CSA, UL, LROS, ÖVE
UL File Number		File E164864, CCN NLRV
CSA File Number		File LR 81630, Class 3211 05
Protective treatment		"TC"
Degree of protection	Conforming to IEC 60529	Open GV3P: IP20
Shock resistance	Conforming to IEC 68-2-27	On: 15 gn - 11 ms Off: 30 gn - 11 ms
Vibration resistance	Conforming to IEC 68-2-6	4 gn (5...300 Hz)
Ambient air temperature	Storage	-40 to +176 °F (-40 to +80 °C)
	Operation	Open: -4 to +140 °F (-20 to +60 °C); Enclosed: -4 to +104 °F (-20 to +40 °C)
Temperature compensation	Conforming to IEC 60157-1	Open: -4 to +140 °F (-20 to +60 °C); Enclosed: -4 to +104 °F (-20 to +40 °C)
Flame resistance	Conforming to IEC 60695-2-1	Conforms for 1760 °F (960 °C)
Maximum operating altitude	Without derating	9843 ft. (3000 m)

Table 22: Technical Characteristics, GV3P13–65

Type	GV3P13–65			
Operating position				
Wiring Number of conductors and c.s.a.	Minimum		Maximum	
Solid cable				
Flexible cable <i>without</i> cable end	1 x 16–2 AWG	2 x 1 mm ²	1 x 16–4 AWG + 1 x 2 AWG	1 x 25 mm ² and 1 x 35 mm ²
Flexible cable <i>with</i> cable end				
Tightening torque	44.25 lb-in	5 N•m	44.25 lb-in for 25 mm ² 70.81 lb-in for 35 mm ²	5 N•m for 25 mm ² 8 N•m for 35 mm ²

Table 23: Technical Characteristics, GV3P13–P65

Type	GV3P13–P65	
Rated insulation voltage (UI)	Conforming to IEC 60947-2	690 V
	Conforming to CSA C 22.2 No. 14 and UL 508	600 (B600) V
Maximum conventional rated thermal current (Ith)	Conforming to IEC 60947-4-1	65 A
Mechanical life (varies with conditions)		50,000 close–open operations
Electrical life	AC-3 duty	50,000 operating cycles
Maximum operating rate		25 operating cycles/h
Sensitivity to phase failure		Conforming to IEC 60947-4-1 Sec 7-2-1-5-2

GV2, GV3, and GV7 Manual Motor Starters, Controllers, and Protectors Specifications and Operating Curves

Table 24: Characteristics of Electrical Trip Units

Manual Starter and Protector Type		GV2ME, GV2P, and GV3P		GV2ME only	GV7R		
Catalog number suffix		GVAU	GVAS	GVAX ^[1]	GV7AU	GV7AS	
Rated insulation voltage (Ui)	Conforming to IEC 60947-1	690 V	690 V	500 V	690 V	690 V	
	Conforming to CSA C22-2 n° 14, UL 508	600 V	600 V	—	600 V	600 V	
Operational voltage (Un)	Conforming to IEC 60947-1	0.85–1.1 V	0.7–1.1 V	0.85–1.1 V	0.85–1.1 V	0.7–1.1 V	
Drop-out voltage (V)		0.7–0.35 Un	0.75–0.2 Un	0.7–0.35 Un	0.35–0.7 Ue	0.2–0.75 Ue	
Inrush consumption	AC	12 VA	14 VA	12 VA	< 10 VA		
	DC	8 W	10.5 W	8 W	< 5 W		
Sealed consumption	AC	3.5 VA	5 VA	3.5 VA	< 5 VA		
	DC	1.1 W	1.6 W	1.1 W	< 5 W		
Operating time	Conforming to IEC 60947-1	10–15 ms				< 50 ms	
	From the moment the voltage reaches its operational value until the manual starter and protector opens.						
On-load factor		100%			100%		
Cabling	Number of conductors	2 or 4			1		
	Solid cable	1–2.5 mm ²			1.5 mm ²		
	Flexible cable <i>without</i> cable end	0.75–2.5 mm ²			1.5 mm ²		
	Flexible cable <i>with</i> cable end	0.75–1.5 mm ²			1 mm ²		
Tightening torque		1.4 maximum N•m			1.2 N•m		

¹ For the wiring diagram of the undervoltage trip unit for dangerous machines (conforming to INRS) on **GV2ME** only, see page 62

GV2, GV3, and GV7 Manual Motor Starters, Controllers, and Protectors Specifications and Operating Curves

GV3 Auxiliary Contact Specifications

Table 25: Auxiliary Contacts for GV2 and GV3P Manual Motor Starters, Controllers, and Protectors

Type of contacts		Units	Instantaneous auxiliary GVAN, GVAD							Fault signaling GVAD, GVAM11				Instantaneous auxiliary GVAE			
Rated insulation voltage (Ui) (associated insulation coordination)	Conforming to IEC 60947-1	V	690							690				250 (690 in relation to main circuit)			
	Conforming to CSA C22-2 n° 14 and UL 508	V	600							300				300			
Conventional thermal current (Ith)	Conforming to IEC 60947-5-1	A	6							2.5				2.5			
	Conforming to CSA C22-2 n° 14 and UL 508	A	5							1				1			
Operational power and current— AC operation Conforming to IEC 60947-5-1	Rated operational voltage (Ue)	V	AC-15/100,000 C.O. [1] 48 110 230 380 440 500 690 127 240 415							AC-14/1000 C.O. [1] 24 48 110 230 127 240				AC-15/100,000 C.O. [1] 24 48 110 230 127 240			
	Operational power, normal conditions	VA	300	500	720	850	650	500	400	36	48	72	72	48	60	120	120
	Occasional breaking and making capacities, abnormal conditions	kVA	3	7	13	15	13	12	9	0.22	0.3	0.45	0.45	0.48	0.6	1.27	2.4
	Rated operational current (Ie)	A	6	4.5	3.3	2.2	1.5	1	0.6	1.5	1	0.5	0.3	2	1.25	1	0.5
Operational power and current— DC operation Conforming to IEC 60947-5-1	Rated operational voltage (Ue)	V	DC-13/100,000 C.O. [1] 24 48 60 110 240 [2] — —							DC-13/1000 C.O. [1] 24 48 60 —				DC-13/100,000 C.O. [1] 24 48 60 —			
	Operational power, normal conditions	W	140	240	180	140	120	—	—	24	15	9	—	24	15	9	—
	Occasional breaking and making capacities, abnormal conditions	W	240	360	240	210	180	—	—	100	50	50	—	100	50	50	—
	Rated operational current (Ie)	A	6	5	3	1.3	0.5	—	—	1	0.3	0.15	—	1	0.3	0.15	—
Low power switching reliability of contact (varies with conditions)			GVAE: Number of failures for <i>n</i> million operating cycles (17 V, 5 mA): = 10 ⁻⁶														
Minimum operational conditions— DC operation		V	17														
		mA	5														
Short-circuit protection			GB2CB ** circuit breaker (rated according to operational current for Ue < 415 V) or via gG fuse 10 A maximum										GB2CB06 or gG fuse 10 A maximum				
Cabling, screw clamp terminals	Number of conductors		1			2											
	Solid cable	mm ²	1–2.5			1–2.5											
	Flexible cable <i>without</i> cable end	mm ²	0.75–2.5			0.75–2.5											
	Flexible cable <i>with</i> cable end	mm ²	0.75–1.5			0.75–1.5											
	Tightening torque	N•m	1.4 maximum			1.4 maximum											
Cabling, spring terminal connections			GVAN only							—				—			
	Flexible cable <i>without</i> cable end	mm ²	0.75–2.5			0.75–2.5				—				0.75–1.5			
Operation of instantaneous auxiliary contacts			<p>Power poles: 0 1</p> <p>GVAN20 N.O. [Closed at 0, Open at 1] GVAN11 N.O. [Closed at 0, Open at 1] GVAE1 N.O. [Closed at 0, Open at 1] GVAE1 N.C. [Open at 0, Closed at 1] GVAE20 N.O. [Closed at 0, Open at 1] GVAE20 N.O. [Closed at 0, Open at 1] GVAE11 N.O. [Closed at 0, Open at 1] GVAE11 N.C. [Open at 0, Closed at 1] GVAD**10 N.O. [Closed at 0, Open at 1] GVAD**01 N.C. [Open at 0, Closed at 1]</p> <p>Legend: Contact open Contact closed</p>														
			<p>Operation of fault signaling contacts</p> <p>GVAM11 Change of state following trip on short circuit.</p> <p>GVAD10** and GVAD01** Change of state following trip on short circuit, overload, or undervoltage.</p>														

¹ C.O. = close–open operations.

² Add an RC circuit type LA4 D to the load terminals. Consult the *Digest*.

GV2, GV3, and GV7 Manual Motor Starters, Controllers, and Protectors Specifications and Operating Curves

GV3 Operating Curves

Table 26: Thermal-Magnetic Trip Curves for GV3P

Average operating times at 68 °F (20 °C) related to multiples of the setting current
NOTE: GV3ME is not available in the USA.

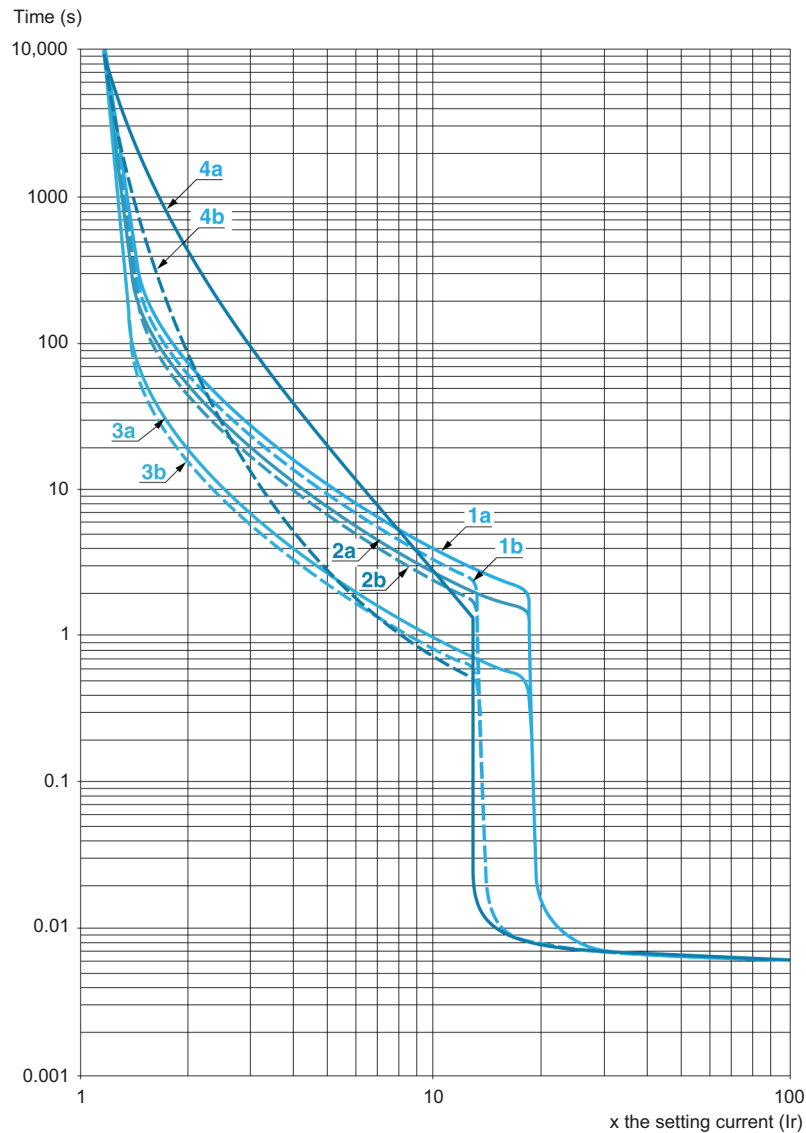

- 1a. 3 poles from cold state (Ir minimum): GV3 P
- 1b. 3 poles from cold state (Ir maximum): GV3 P
- 2a. 2 poles from cold state (Ir minimum): GV3 P
- 2b. 2 poles from cold state (Ir maximum): GV3 P
- 3a. 3 poles from hot state (Ir minimum): GV3 P
- 3b. 3 poles from hot state (Ir maximum): GV3 P
- 4a. 3 poles from hot state (Ir minimum): GV3 ME80
- 4b. 3 poles from hot state (Ir maximum): GV3 ME80

GV2, GV3, and GV7 Manual Motor Starters, Controllers, and Protectors Specifications and Operating Curves

Table 27: Current Limitation on Short Circuit for GV3P

Dynamic stress

$I_{peak} = f(\text{prospective } I_{sc}) \text{ at } 1.05 U_e = 435 \text{ V}$

NOTE: GV3ME is not available in the USA.

Limited peak current (kA)

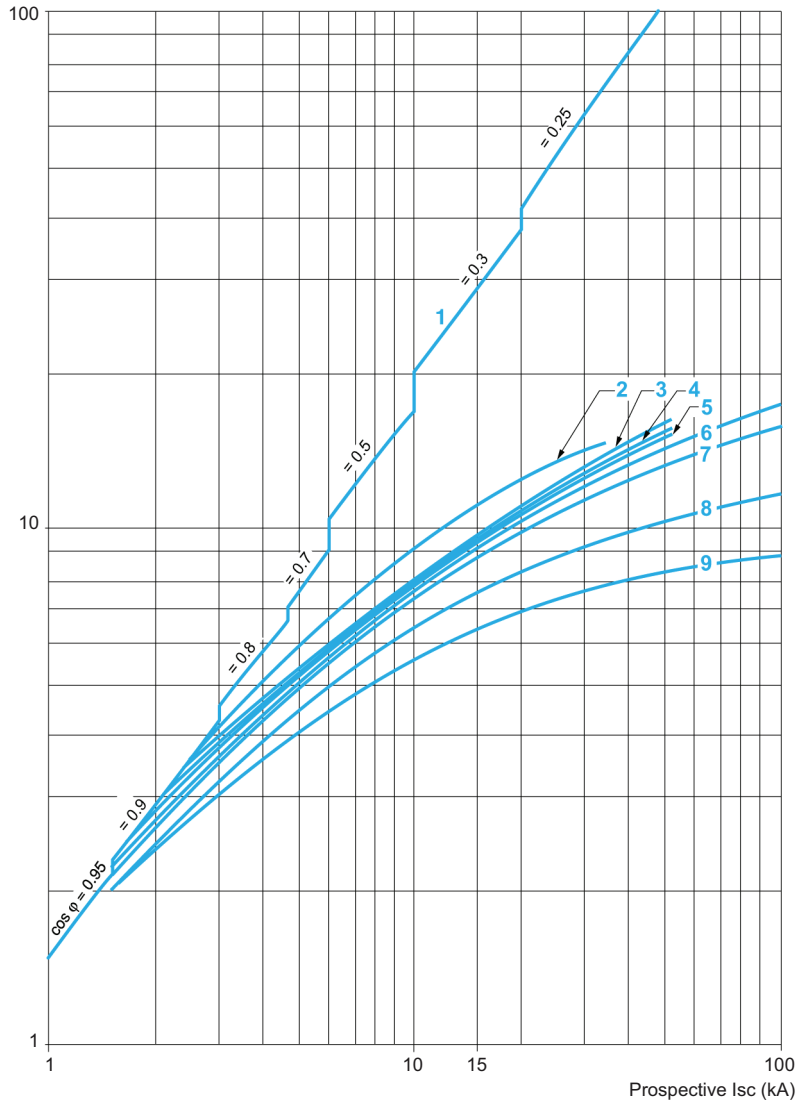

- | | |
|-------------------------|------------|
| 1. Maximum peak current | 6. 23–32 A |
| 2. 56–80 A | 7. 17–25 A |
| 3. 48–65 A | 8. 12–18 A |
| 4. 37–50 A | 9. 9–13 A |
| 5. 30–40 A | |

GV2, GV3, and GV7 Manual Motor Starters, Controllers, and Protectors Specifications and Operating Curves

Table 28: Thermal Limit on Short Circuit for GV3P

Thermal limit in kA²s in the magnetic operating zone
 Sum of I²dt = f (prospective I_{sc}) at 1.05 U_e = 435 V
 GV3ME is not available in the USA.

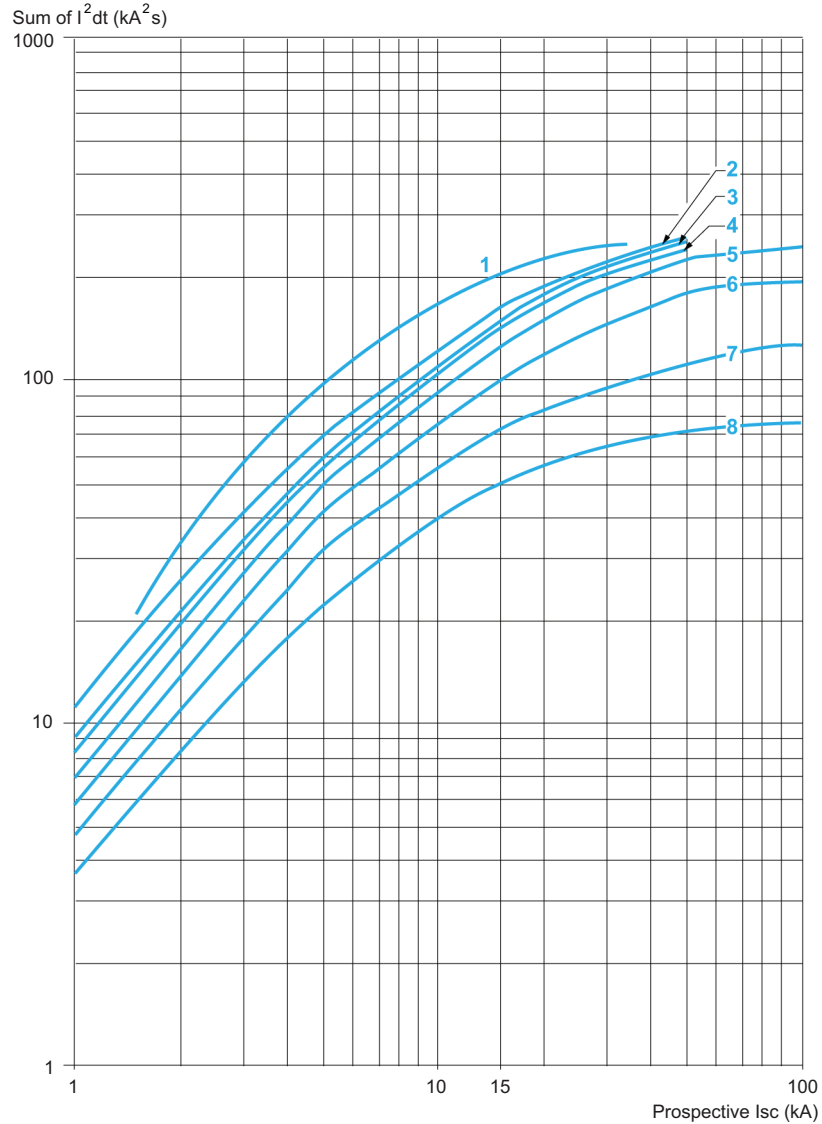

- | | |
|-----------------------|----------------------|
| 1. 56–80 A (GV3 ME80) | 5. 23–32 A (GV3 P32) |
| 2. 48–65 A (GV3 P65) | 6. 17–25 A (GV3 P25) |
| 3. 37–50 A (GV3 P50) | 7. 12–18 A (GV3 P18) |
| 4. 30–40 V (GV3 P40) | 8. 9–13 A (GV3 P13) |

GV2, GV3, and GV7 Manual Motor Starters, Controllers, and Protectors

Specifications and Operating Curves

GV7 Specifications

Table 29: Environment

Conforming to standards		IEC 60947-1, 60947-2, 60947-4-1, EN 60947-1, 60947-2, 60947-4-1, NF C 63-650, 63-120, 79-130, VDE 0113, UL 508, CSA C22.2 No.14
Approvals		UL File E 164864 CCN NLRV CSA File LR 81630 Class 3211 05
Protective treatment		"TC"
Degree of protection Conforming to IEC 60529		IP405 with terminal shields
Ambient air temperature	Storage	-68 °F to +203 °F (-55 °C to +95 °C)
	Operation	-13 °F to +158 °F (-25 °C to +70 °C)
Temperature compensation		-13 °F to +130 °F (-25 °C to +55 °C) For use up to +158 °F (70 °C), consult your local sales office.
Maximum operating altitude		6562 ft. (2000 m)
Operating position		
Suitability for isolation Conforming to IEC 60947-1 7-1-6		Yes
Vibration resistance		2.5 g _n at 25 Hz
Phase loss sensitivity		Conforming to IEC 60947-4-1, 7-2-1-5-2

Table 30: Cabling Characteristics

Type		Connection by bars or cables		
		GV7R•40–R•100	GV7R•150	GV7R•220
Pitch	Without spreaders	1.4 in. (35 mm)		
	With spreaders	1.8 in. (45 mm)		
Bars or cables with lugs	e	0.24 in. (≤6 mm)		
	L	1 in. (≤25 mm)		
	d	0.39 in. (≤10mm)		
Screws	Size	M6	M8	
	Tightening torque	7.5 lb-ft (10 N•m)	11.3 lb-ft (15 N•m)	
Bare cables (copper or aluminum) with connectors	Height	0.78 in. (20 mm)		
	Wire size	16 AWG (1.5 mm ²)	16–3/0 AWG (1.5–95 mm ²)	16 AWG–350 mcm (1.5–185 mm ²)
	Tightening torque	11.3 lb-ft (15 N•m)		

GV2, GV3, and GV7 Manual Motor Starters, Controllers, and Protectors Specifications and Operating Curves

Table 31: Technical Characteristics

Type			GV7									
			RE20-RE100	RS40-RS100	RE150	RS150	RE220	RS220				
Utilization category	Conforming to IEC 60947-2		A		A		A					
	Conforming to IEC 60947-4-1		AC-3		AC-3		AC-3					
Rated operational voltage (Ue) conforming to IEC 60947-2			690 V		690 V		690 V					
Rated insulation voltage (Ui) conforming to IEC 60947-2			750 V		750 V		750 V					
Rated voltage conforming to CSA C22.2 No. 14, UL 508			600 V		600 V		600 V					
Rated operational frequency ^[1] conforming to IEC 60947-2			50/60 Hz		50/60 Hz		50/60 Hz					
Rated impulse withstand voltage (U imp) conforming to IEC 60947-2			8 kV		8 kV		8 kV					
Total power dissipated per pole			5 W		8.7 W		14.5 W					
Electrical durability (C.O. = close-open cycles)	440 V	In/2	50,000 C.O.		40,000 C.O.		20,000 C.O.					
	440 V	In	30,000 C.O.		20,000 C.O.		10,000 C.O.					
Rated duty, conforming to IEC 60947-4-1			Continuous duty		Continuous duty		Continuous duty					
Type			GV7									
			RE40-RE100	RS40-RS100	RE150	RS150	RE220	RS220				
Rating			25-40 A to 60-100 A		90-150 A		90-150 A		132-220 A		132-220 A	
Breaking capacity conforming to IEC 60947-2	230/240 V	Icu ^[2]	85 kA	100 kA	85 kA	100 kA	85 kA	100 kA	85 kA	100 kA		
		Ics% ^[3]	100%	100%	100%	100%	100%	100%	100%	100%		
	400/415 V	Icu ^[2]	25 kA	70 kA	35 kA	70 kA	35 kA	70 kA	35 kA	70 kA		
		Ics% ^[3]	100%	100%	100%	100%	100%	100%	100%	100%		
	440 V	Icu ^[2]	25 kA	65 kA	35 kA	65 kA	35 kA	65 kA	35 kA	65 kA		
		Ics% ^[3]	100%	100%	100%	100%	100%	100%	100%	100%		
	500 V	Icu ^[2]	18 kA	50 kA	30 kA	50 kA	30 kA	50 kA	30 kA	50 kA		
		Ics% ^[3]	100%	100%	100%	100%	100%	100%	100%	100%		
	690 V	Icu ^[2]	8 kA	10 kA	8 kA	10 kA	8 kA	10 kA	8 kA	10 kA		
		Ics% ^[3]	100%	100%	100%	100%	100%	100%	100%	100%		

¹ GV7R motor controllers and protectors are not recommended for use with variable speed controllers or soft start units in applications under 40 Hz.

² Icu = interrupting capacity at full voltage.

³ Ics = short-circuit interrupting capacity as a percentage of Icu.

Table 32: UL Maximum SCCR (rms) (kA) ^[1, 2]

Type	Range	SCCR		
		240 V ^[3]	480 V ^[3]	600 V ^[3]
GV7RE40	25-40 A	25	25	10
GV7RE50	30-50 A	25	25	10
GV7RE80	48-80 A	25	25	10
GV7RE100	60-100 A	25	25	10
GV7RE150	90-150 A	25	25	10
GV7RE220	132-220 A	25	25	10
GV7RS40	25-40 A	65	65	10
GV7RS50	30-50 A	65	65	10
GV7RS80	48-80 A	65	65	10
GV7RS100	60-100 A	65	65	10
GV7RS150	90-150 A	65	65	10
GV7RS220	132-220 A	65	65	10

¹ Group Installation: Maximum NTD fuse size: 1200 A. Maximum manual starter and protector rating: 1200 A.

² Suitable for use on a circuit with an available SCCR no greater than the SCCR of the manual motor controller or manual starter and protector, whichever is less.

³ Nominal system voltage.

GV2, GV3, and GV7 Manual Motor Starters, Controllers, and Protectors Specifications and Operating Curves

GV7 Auxiliary Contact Specifications

Table 33: Auxiliary Contact Characteristics

Type of contacts			GV7AE11							GV7AB11							
Rated insulation voltage (Ui) (associated insulation coordination)	Conforming to IEC 60947-1 from CSA C22.2 No. 14 and UL 508	V	690							690							
Conventional thermal current (Ith)	Conforming to IEC 60947-5-1 from CSA C22.2 No. 14 and UL 508	A	6							6							
Mechanical durability (C.O.: Close - Open)		C.O.	50 000							50 000							
Operational current—AC operation Conforming to IEC 60947-5-1	Rated operational voltage (Ue)	V	AC-12 or AC-15. 50,000 C.O.							AC-12 or AC-15. 50,000 C.O.							
			24	48	110	230/240	380/415	440	690	24	48	110	230/240	380/415	440	690	
	Rated operational current (Ie)	AC-12	A	6	6	6	6	6	6	6	5	5	5	5	5	5	
		AC-15	A	6	6	5	4	3	3	0.1	5	5	4	3	2.5	2.5	0.1
Operational current—DC operation Conforming to IEC 60947-5-1	Rated operational voltage (Ue)	V	DC-12 or DC-14. 50,000 C.O.							DC-12 or DC-14. 50,000 C.O.							
			24	48	110	250	24	48	110	250							
	Rated operational current (Ie)	DC-12	A	2.5	2.5	0.8	0.3	2	2	0.5	—						
		DC-14	A	1	0.2	0.5	0.03	0.5	0.1	0.25	—						
Minimum operational conditions—DC operation		V	17							12							
		mA	5							5							
Short-circuit protection			GB2CB** circuit breaker (rating according to operational current for Ue ≤ 415 V) or gG fuse, 10 A maximum.														
Cabling	Solid cable	mm ²	1 x 1.5 conductor (1 x 16 AWG)							1 x 1.5 conductor (1 x 16 AWG)							
	Flexible cable <i>without</i> cable end	mm ²	1 x 1.5 conductor (1 x 16 AWG)							1 x 1.5 conductor (1 x 16 AWG)							
	Flexible cable <i>with</i> cable end	mm ²	1 x 1.5 conductor (1 x 16 AWG)							1 x 1.5 conductor (1 x 16 AWG)							

Table 34: Electrical Characteristics

Type	GV7AU or GV7AS
Rated insulation voltage (Ui) conforming to IEC 60947-1	690 V
Operational voltage conforming to IEC 60947-1	0.85–1.1 Ue (V)
Drop-out voltage	0.35–0.7 Ue (V)
Inrush consumption	<10 VA
	<5 W
Sealed consumption	<5 VA
	<5 W
Operating time conforming to IEC 60947-1	<50 ms
On-load factor	100%
Cabling, solid or flexible cable	2 x 16 AWG (2 x 1.5 mm ²) maximum

GV2, GV3, and GV7 Manual Motor Starters, Controllers, and Protectors Specifications and Operating Curves

GV7 Operating Curves

The current limiting capacity of the motor starter and protector is expressed by two curves that illustrate the following, as a function of the prospective short-circuit current (the current that would flow if no protection devices were installed):

- The actual peak current (limited)
- The thermal stress (in A^2s), that is, the energy dissipated by the short-circuit in a conductor with a resistance of 1Ω

Example—The actual peak value of a 70 kA prospective short-circuit current limited by a **GV7RS220** is 20 kA. See page 32.

Table 35: Permissible Thermal Stresses for Cables (A^2s)

S (mm ²)	1.5	2.5	4	6	10	16	25	35	50	
AWG	16	14	12	10	8	6	4	2	1	
PVC Insulation	Cu	2.97×10^4	8.26×10^4	2.12×10^5	4.76×10^5	1.32×10^6	3.4×10^6	8.26×10^6	1.62×10^7	3.31×10^7
	Al	—	—	5.41×10^5	1.39×10^6	3.38×10^6	6.64×10^6	1.35×10^7	—	—
PRC [1]	Cu	4.10×10^4	1.39×10^5	2.92×10^5	6.56×10^5	1.82×10^6	4.69×10^6	1.39×10^7	2.23×10^7	4.56×10^7
	Al	—	—	7.52×10^5	1.93×10^6	4.70×10^6	9.23×10^6	1.88×10^7	—	—

¹ PRC = Cross-linked polyethylene

Example—For a **GV7RS220**, the peak value is limited to 20 kA for a prospective I_{sc} of 40 kA.

Example—For a **GV7RS220**, and with a prospective I_{sc} of 40 kA, an I^2t of $7.5 \times 10^5 A^2s$ is obtained, which requires the use of a PVC insulated copper cable with a wire size of 10 mm² (8 AWG).

GV2, GV3, and GV7 Manual Motor Starters, Controllers, and Protectors Specifications and Operating Curves

Table 36: Thermal-Magnetic Trip Curves for GV7R

Average operating time at 68 °F (20 °C) as a function of multiples of the setting current

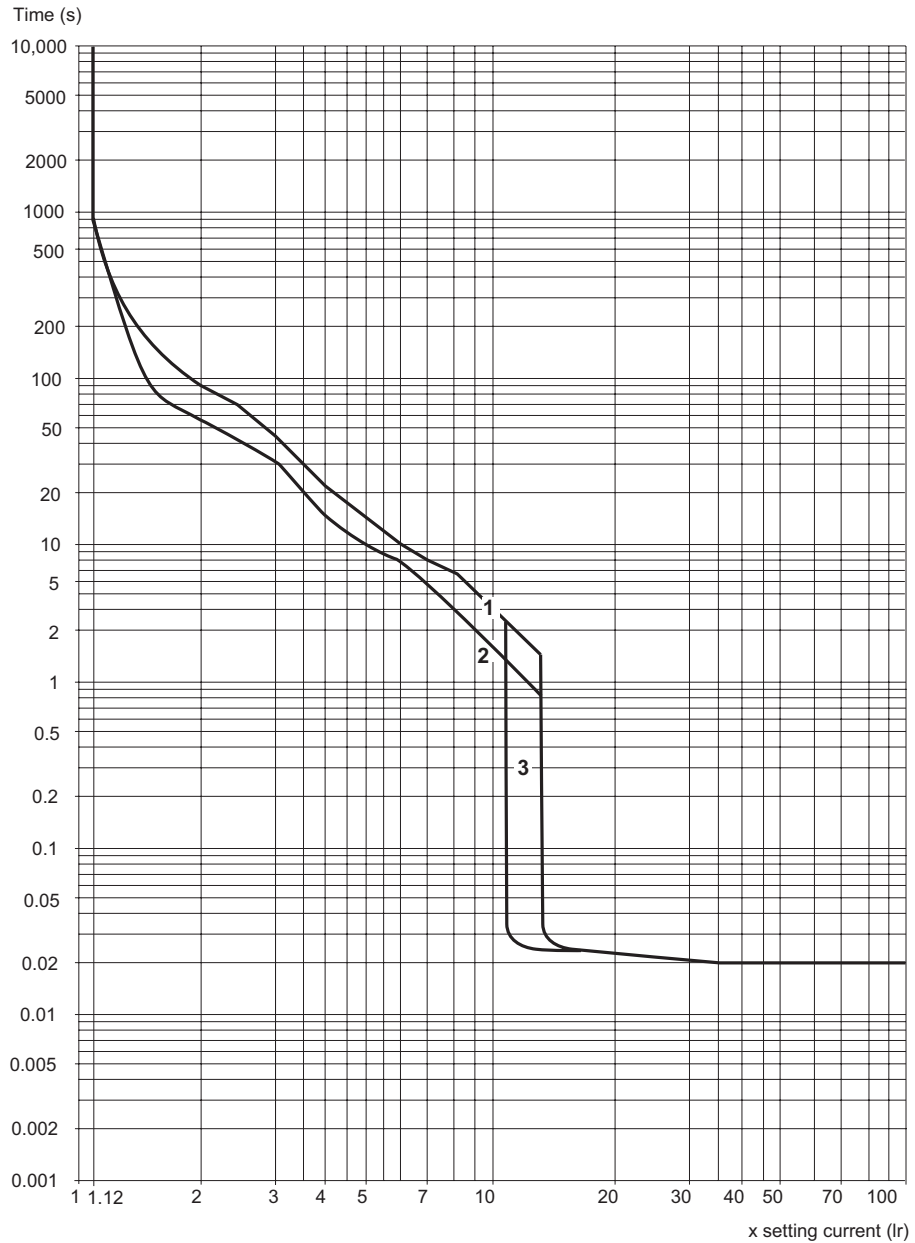

1. Curve from cold state
2. Curve from hot state
3. 12–14 I_r
In the event of total phase failure, trip occurs after 4 s ± 20%

GV2, GV3, and GV7 Manual Motor Starters, Controllers, and Protectors Specifications and Operating Curves

Table 37: Current Limitation on Short Circuit for GV7R

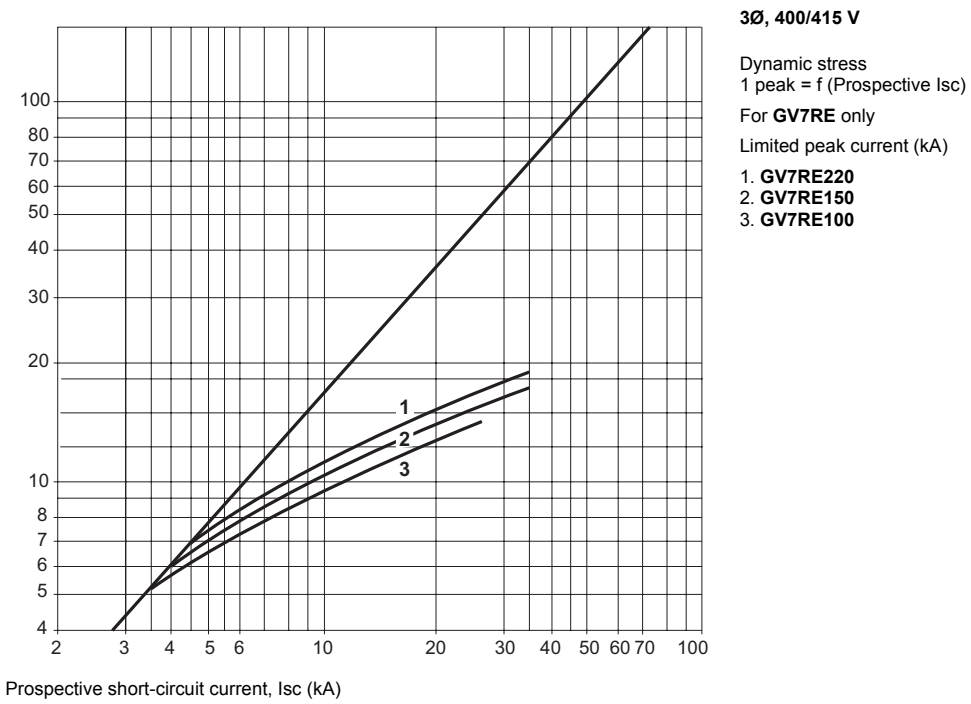
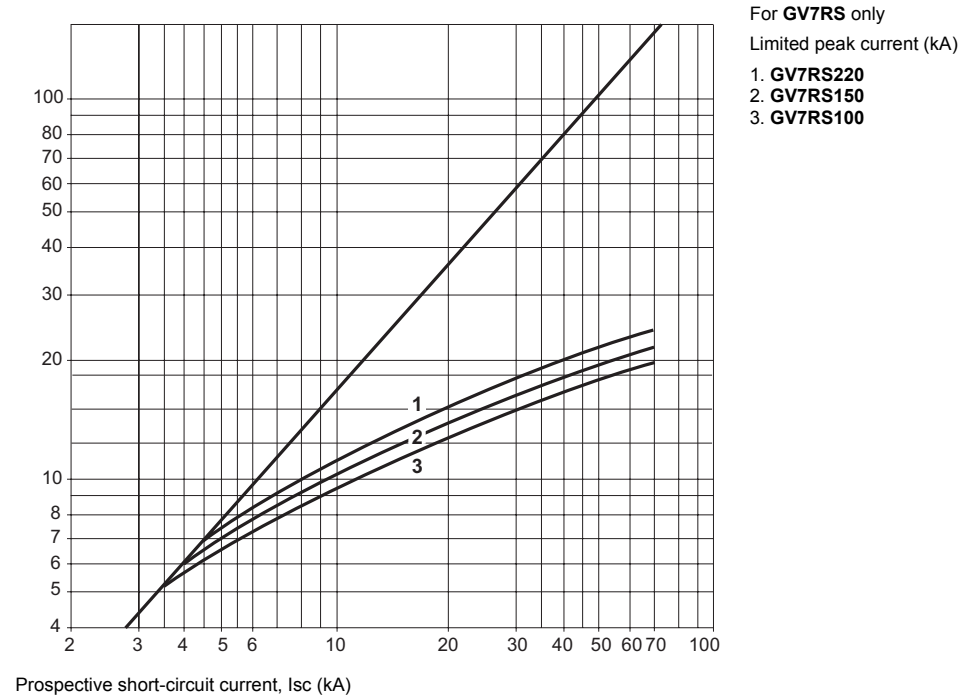
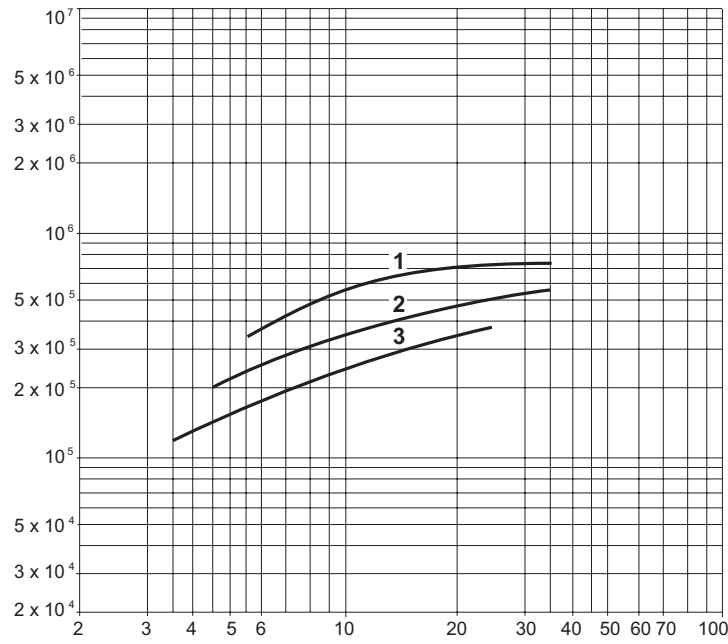

Table 38: Current Limitation on Short Circuit for GV7RS



GV2, GV3, and GV7 Manual Motor Starters, Controllers, and Protectors Specifications and Operating Curves

Table 39: Thermal Limit on Short Circuit for GV7R



3Ø, 400/415 V

Thermal limit
 $i^2dt = f(\text{Prospective } I_{sc})$

For **GV7RE** only

Sum of i^2dt (A²s)

1. **GV7RE220**

2. **GV7RE150**

3. **GV7RE100**

Prospective short-circuit current, I_{sc} (kA)

Table 40: Thermal Limit on Short Circuit for GV7RS

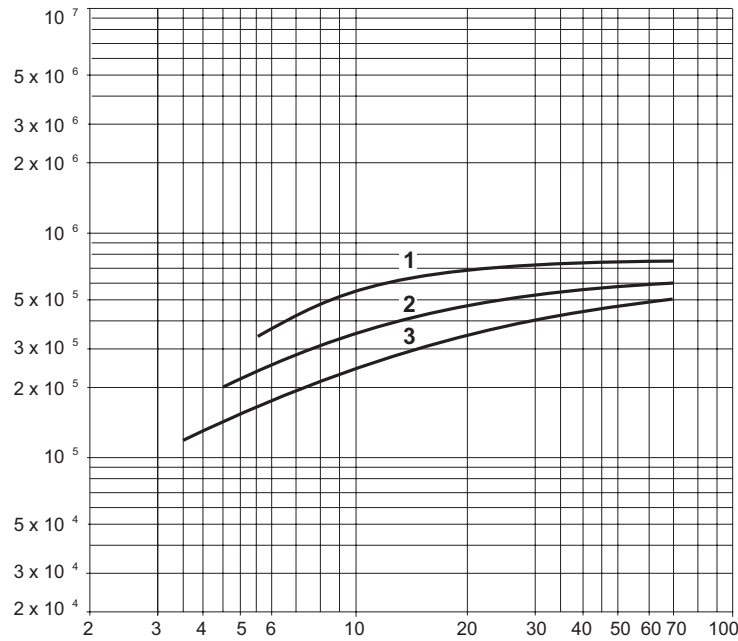

For **GV7RS** only

Sum of i^2dt (A²s)

1. **GV7RS220**

2. **GV7RS150**

3. **GV7RS100**

Prospective short-circuit current, I_{sc} (kA)

GV2, GV3, and GV7 Manual Motor Starters, Controllers, and Protectors Specifications and Operating Curves

Table 41: Current Limitation on Short Circuit for GV7R

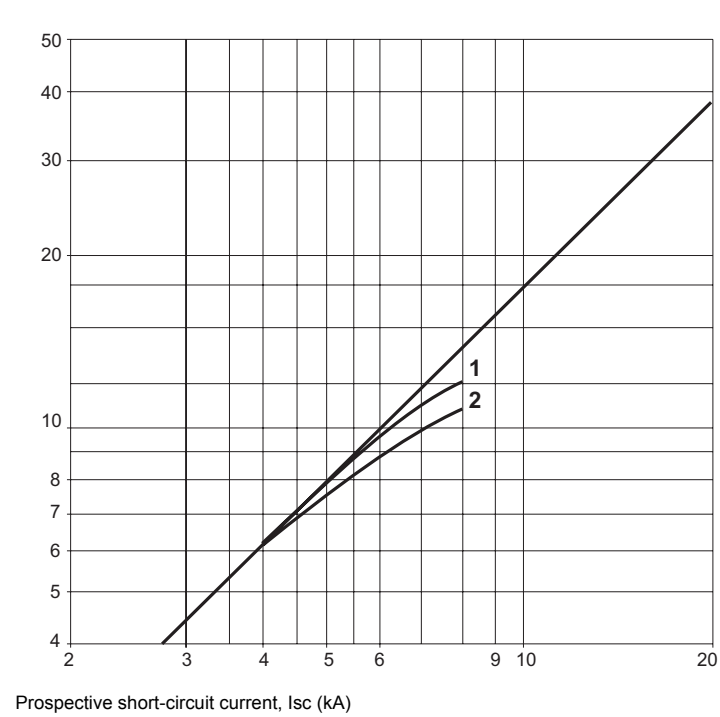
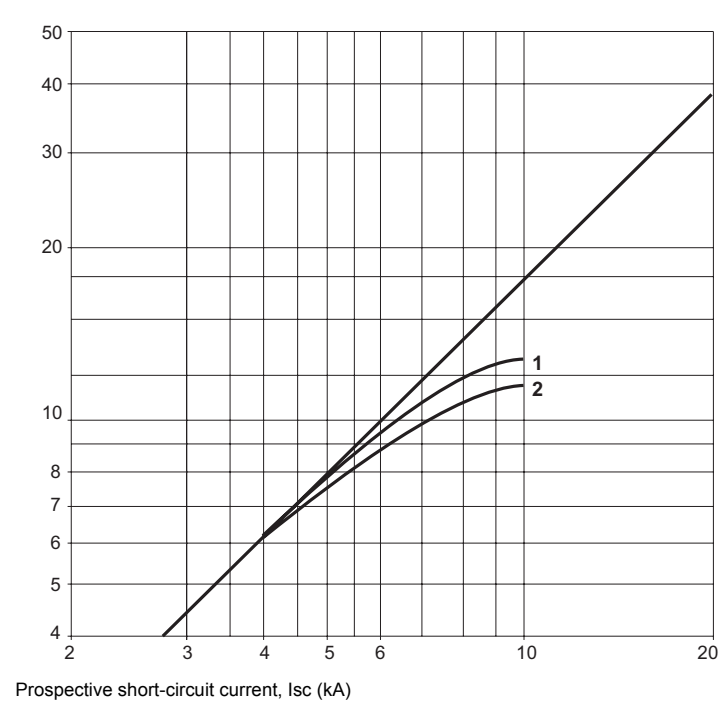
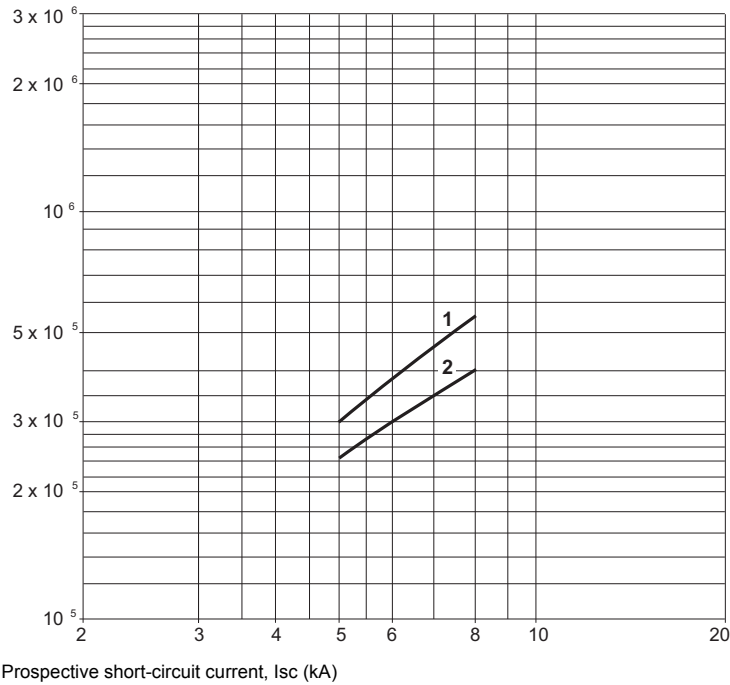

Table 42: Current Limitation on Short Circuit for GV7RS



GV2, GV3, and GV7 Manual Motor Starters, Controllers, and Protectors Specifications and Operating Curves

Table 43: Thermal Limit on Short Circuit for GV7R



3Ø, 690 V

Thermal limit
I²dt = f (Prospective I_{sc})

For **GV7RE** only

Sum of I²dt (A²s)

1. **GV7RE220**

2. **GV7RE150** and **GV7RE100**

Table 44: Thermal Limit on Short Circuit for GV7RS

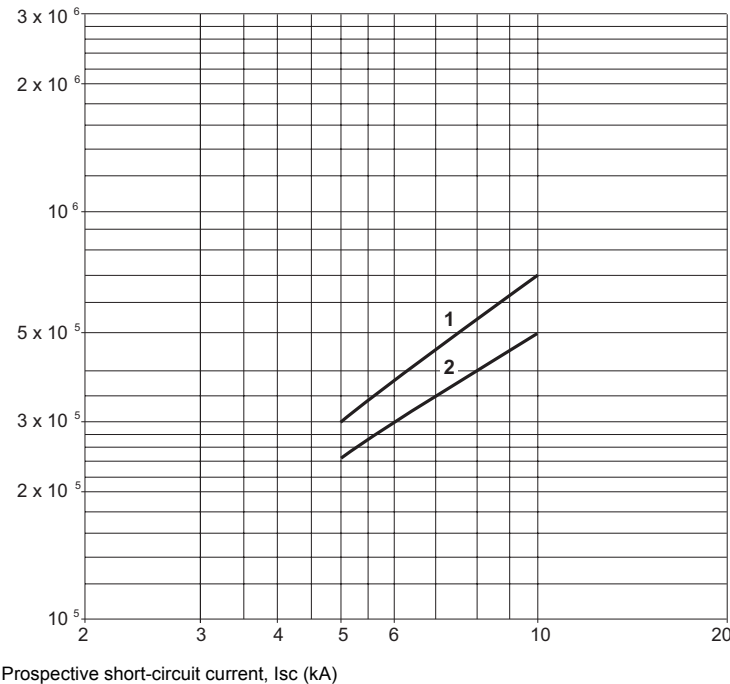

For **GV7RS** only

Sum of I²dt (A²s)

1. **GV7RE220**

2. **GV7RE150** and **GV7RE100**

**GV2, GV3, and GV7 Manual Motor Starters, Controllers, and Protectors
Specifications and Operating Curves**

Selection

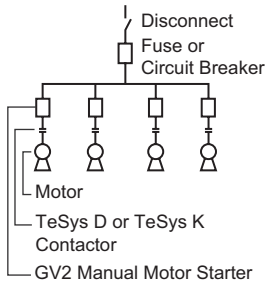

Fuse and Circuit Breaker Selection

When selecting the proper upstream short circuit protection for Group Motor installations, you must apply the specific rules of the National Electrical Code (NEC) for Group Motor installations. To help clarify this process, below are examples of how to choose the correct GV manual starter and the proper size short circuit protection for an application. These examples illustrate the most common applications of GV manual starters with upstream short circuit protection in a Group Motor installation. Refer to **NEC section 430-53C** and **section 430-53D** for proper conductor ampacity selection.

NOTE: The examples below show full-load ampere (FLA) ratings that may not be typical. Use the motor nameplate data to determine actual values.

Example 1: Eight motors with the sizes shown in Table 45 are installed on a conveying system. Time-delay fuses are used.

Table 45: Example 1—Motor Sizes

Motor Quantity	Rating (hp)	Voltage	FLA	Starter Selected
1	5	460	7.6	GV2ME14
2	3	460	4.8	GV2ME10
5	2	460	3.4	GV2ME08

In accordance with NEC section 430-52, section 430-53, and table 430-152, the time-delay fuse must be sized as follows:

$$\text{175\% FLA for largest motor + sum of FLAs for all other motors} \\ \Rightarrow (1.75 \times 7.6) + (2 \times 4.8) + (5 \times 3.4) = 39.9 \text{ A}$$

NEC 430-52 allows use of the next largest standard-size fuse—which in this case is 40 A. If nuisance tripping is a problem with this fuse selection, NEC does allow 225% of the largest motor FLA to be used in lieu of 175% when calculating the size. In this case, the calculation is as follows (the next largest standard fuse size in this case is 45 A):

$$(2.25 \times 7.6) + (2 \times 4.8) + (5 \times 3.4) = 43.7 \text{ A}$$

Example 2: Ten motors with the sizes shown in Table 46 are installed on a packaging machine. Choose the proper size inverse-time circuit breaker for this application.

Table 46: Example 2—Motor Sizes

Motor Quantity	Rating (hp)	Voltage	FLA
2	10	460	14
1	5	460	7.6
2	3	460	4.8
5	2	460	3.4

In accordance with NEC section 430-52, section 430-53, and NEC table 430-152, the inverse-time circuit breaker must be sized as follows (the next largest standard-size inverse-time circuit breaker is 90 A):

$$\text{250\% FLA for largest motor + sum of FLAs for all other motors} \\ \Rightarrow (2.5 \times 14) + 14 + 7.6 + (2 \times 4.8) + (5 \times 3.4) = 83.2 \text{ A}$$

If nuisance tripping is a problem, the NEC allows for inverse-time circuit breaker sizes that “shall in no case exceed 400% for full-load currents of 100 amps or less, or 300% for full-load current greater than 100 amps.” In this case, the calculation is as follows (the next largest standard inverse-time circuit breaker size in this case is 110 A):

$$(4.0 \times 14) + 14 + 7.6 + (2 \times 4.8) + (5 \times 3.4) = 104.2 \text{ A}$$

GV2, GV3, and GV7 Manual Motor Starters, Controllers, and Protectors Selection

GV2 and GV3 Selection

Table 47: GV2 Manual Motor Controller and Protector Horsepower Ratings

Catalog Number		Thermal Trip Setting Range (A)	Maximum Horsepower Ratings						
Push Button	Rotary Handle		1 Ø			3 Ø			
GV2ME [1]	GV2P		120 V	208 V	240 V	208 V	240 V	480 V	600 V [2]
GV2ME01	GV2P01	0.11–0.16	—	—	—	—	—	—	—
GV2ME02	GV2P02	0.016–0.25	—	—	—	—	—	—	—
GV2ME03	GV2P03	0.25–0.40	—	—	—	—	—	—	—
GV2ME04	GV2P04	0.40–0.63	—	—	—	—	—	—	—
GV2ME05	GV2P05	0.63–1	—	—	—	—	—	—	—
GV2ME06	GV2P06	1–1.6	—	—	0.1	—	—	0.75	0.75
GV2ME07	GV2P07	1.6–2.5	—	0.16	0.16	0.5	0.5	1	1.5
GV2ME08	GV2P08	2.5–4	0.125	0.25	0.33	0.75	0.75	2	3
GV2ME10	GV2P10	4–6.3	0.25	0.5	0.5	1	1.5	3	5
GV2ME14	GV2P14	6–10	0.5	1	1.5	2	3	5	7.5
GV2ME16	GV2P16	9–14	0.75	2	2	3	3	10	10
GV2ME20	GV2P20	13–18	1	2	3	5	5	10	15
GV2ME21	GV2P21	17–23	1.5	3	3	5	7.5	15	20
GV2ME22	GV2P22	20–25	2	3	—	7.5	—	15	20
GV2ME32 [3]	GV2P32	24–32	2	5	5	7.5	10	20	25

¹ For spring terminals, add the numeral 3 to the end of the catalog number. Example: GV2ME013.

² GV2P** is not Type E or Type F.

³ GV2ME32 is not available with spring terminals.



File E164864
CCN NLRV



File LR 81630
Class 3211 05

Table 48: GV3P Manual Motor Controller and Protector Horsepower Ratings

Catalog Number	Thermal Trip Setting Range (A)	Maximum Horsepower Ratings					
		1 Ø		3 Ø			
		120 V	240 V	208 V	240 V	480 V	600 V
GV3P13	9–13	0.5	1.5	3	3	7.5	10
GV3P18	12–18	0.75	2	3	5	7.5	10
GV3P25	17–25	1.5	3	5	7.5	15	20
GV3P32	23–32	2	3	7.5	7.5	20	25
GV3P40	30–40	3	5	10	10	25	30
GV3P50	37–50	3	7.5	10	10	30	40
GV3P65	48–65	3	10	15	15	40	50



GV2ME



GV2ME**3



GV2P



GV3P

NOTE: For GV2 and GV3 accessories and enclosures, see pages 40–47.

GV2, GV3, and GV7 Manual Motor Starters, Controllers, and Protectors Selection

GV7 Selection



Standard manual controllers and protectors include terminal and device mounting hardware. Cable clamps and accessories are listed on page 49.

Table 49: GV7R••• Manual Motor Controller and Protector Horsepower Ratings

Thermal Trip Setting Range (A)	IEC Breaking Capacity at 415 V ^[1]	Maximum Horsepower Ratings 3 Ø			Catalog Number	Weight, lb (kg)
		230 V	460 V	575 V		
12–20	25 kA	5	10	15	GV7RE20	4.43 (2.01)
15–25		7.5	15	20	GV7RE25	
25–40		10	30	30	GV7RE40	
30–50		15	30	40	GV7RE50	4.44 (2.02)
48–80		30	60	75	GV7RE80	
60–100		30	75	100	GV7RE100	
90–150	35 kA	50	100	150	GV7RE150	4.45 (2.02)
132–220		75	150	200	GV7RE220	5.20 (2.35)
12–20	65 kA	5	10	15	GV7RS20	4.43 (2.01)
15–25		7.5	15	20	GV7RS25	
25–40		10	30	30	GV7RS40	
30–50		15	30	40	GV7RS50	4.44 (2.02)
48–80		30	60	75	GV7RS80	
60–100		30	75	100	GV7RS100	
90–150		50	100	150	GV7RS150	4.45 (2.02)
132–220		75	150	200	GV7RS220	5.20 (2.35)

¹ Refer to Table 31 on page 28 for ratings at other voltages.

GV2, GV3, and GV7 Manual Motor Starters, Controllers, and Protectors Selection

GV2 and GV3 Accessories

Figure 1: GV2 Accessories

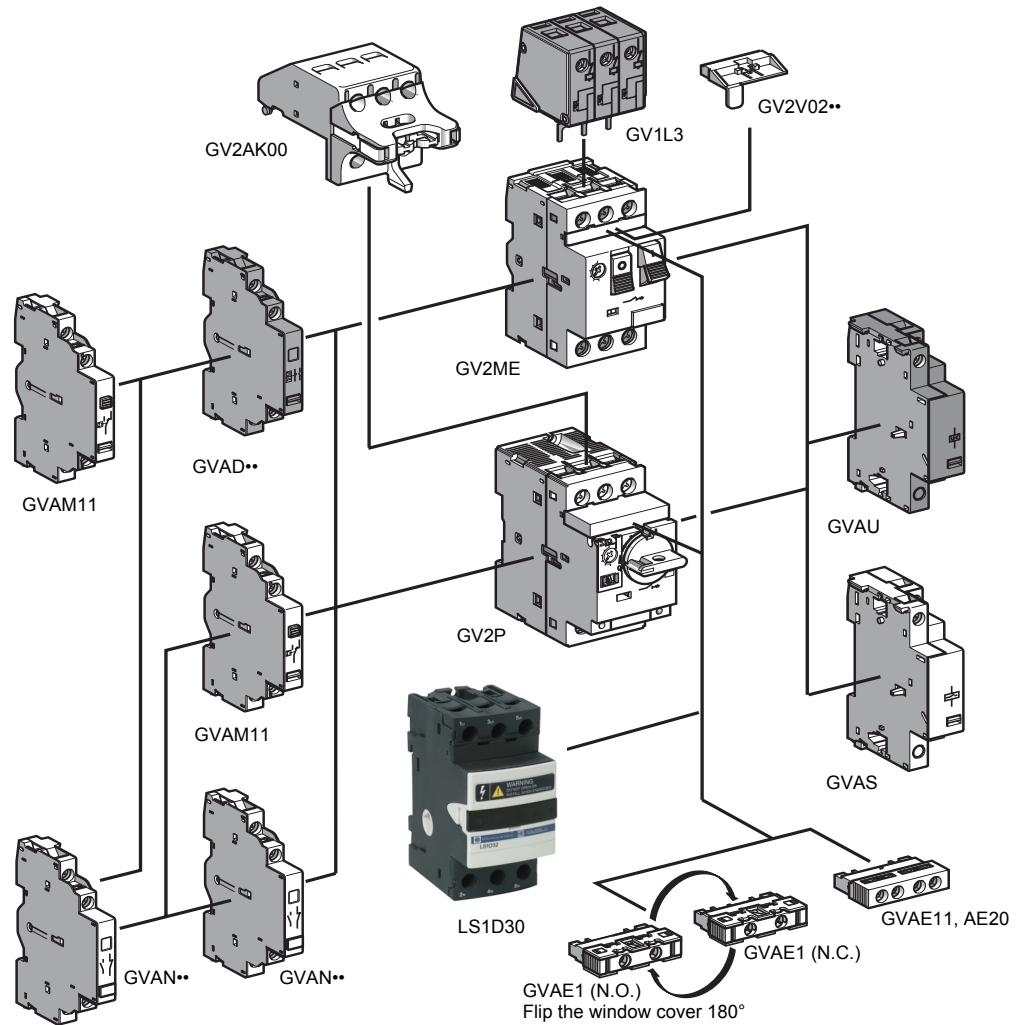

Table 50: GV2 and GV3 Auxiliary Contact Blocks

Description	Mounting Location	Max. No. of Blocks	Contact Type	Sold in Lots of	Catalog Number	Weight lb (kg)
Instantaneous auxiliary contacts	Front ^[1]	1	N.O. or N.C. ^[2]	1	GVAE1	0.03 (0.015)
			N.O. + N.C.	1	GVAE11 ^[3]	0.04 (0.02)
			N.O. + N.O.	1	GVAE20 ^[3]	0.04 (0.02)
	Left side	2	N.O. + N.C.	1	GVAN11 ^[3]	0.11 (0.05)
		N.O. + N.O.	1	GVAN20 ^[3]		
Fault signaling contact and instantaneous auxiliary contact	Left side ^[4]	1	N.O. (fault) + N.O.	1	GVAD1010	0.12 (0.06)
			N.O. (fault) + N.C.	1	GVAD1001	
			N.C. (fault) + N.O.	1	GVAD0110	
			N.C. (fault) + N.C.	1	GVAD0101	
Short-circuit signaling contact	Left side	1	SPDT	1	GV2AM11	0.10 (0.04)

¹ Mounting of a GVAE contact block or a GV2AK00 visible isolation block on GV2P.

² Field convertible for N.C. or N.O. contact operation, depending on the direction in which the reversible block is mounted; flip the window cover 180° to change from N.O. to N.C. or vice versa.

³ For spring terminals, add the numeral 3 to the end of the catalog number. Example: GV2ME013.

⁴ The GVAD contact block is always mounted next to the circuit protector.

GV2, GV3, and GV7 Manual Motor Starters, Controllers, and Protectors Selection

Figure 2: GV3 Accessories

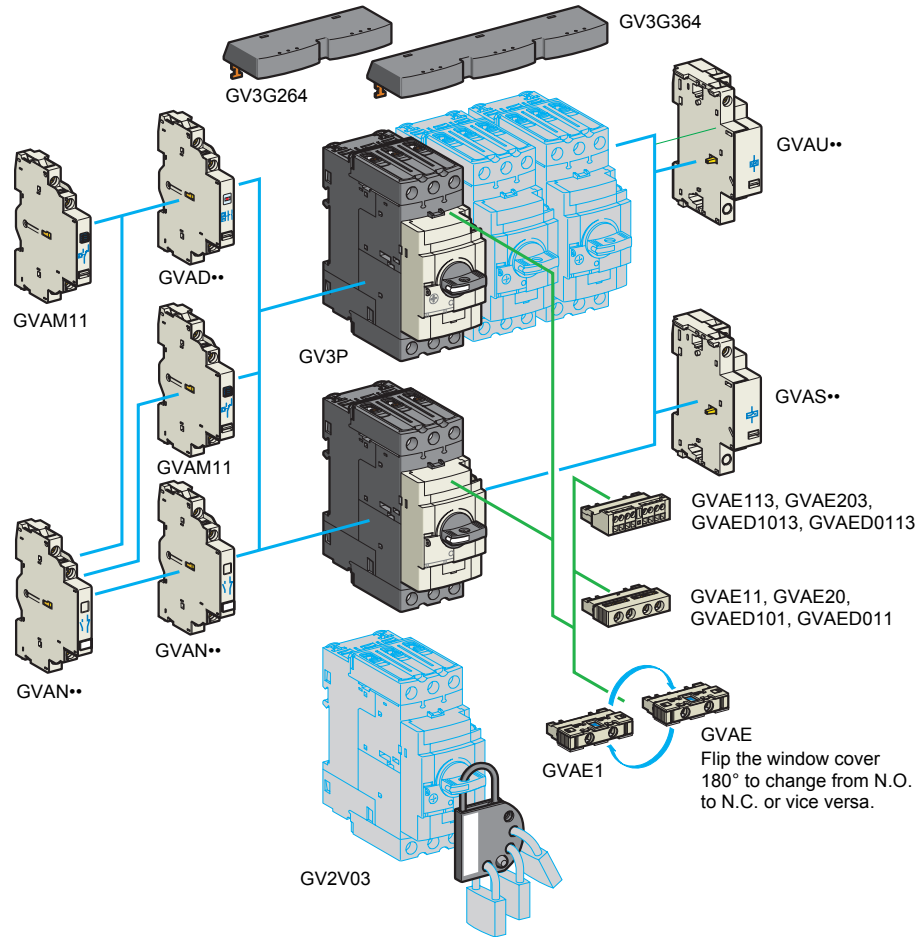

Table 51: GV3 Auxiliary Contact Blocks

Description	Mounting Location	Max. No. of Blocks	Contact Type	Sold in Lots of	Catalog Number	Weight lb (kg)	
Instantaneous auxiliary contacts	Front ^[1]	1	N.O. or N.C. ^[2]	10 ^[3]	GVAE1	0.03 (0.015)	
			N.O. + N.C.	10	GVAE11 ^[4]	0.04 (0.02)	
			N.O. + N.O.	10 ^[3]	GVAE20 ^[4]		
	Left side	2	N.O. + N.C.	1	GVAN11 ^[4]	0.11 (0.05)	
N.O. + N.O.			1	GVAN20 ^[4]			
Fault signaling contact + instantaneous auxiliary contact	Front	1	N.O. (fault) + N.O.	1	GVAED101 ^[4]	0.04 (0.02)	
			+ N.C.	1	GVAED011 ^[4]		
	Left side ^[3]	1	N.O. (fault)	+ N.O.	1	GVAD1010	0.12 (0.06)
				+ N.C.	1	GVAD1001	
			N.C. (fault)	+ N.O.	1	GVAD0110	
				+ N.C.	1	GVAD0101	
Short-circuit signaling contact	Left side	1	C/O common point	1	GVAM11	0.10 (0.04)	

¹ Mounting of a **GVAE** contact block or a **GV2AK00** visible isolation block on **GV2P**.

² Field convertible for N.C. or N.O. contact operation, depending on the direction in which the reversible block is mounted; flip the window cover 180° to change from N.O. to N.C. or vice versa.

³ The **GVAD** contact block is always mounted next to the circuit protector.

⁴ For spring terminals, add the numeral 3 to the end of the catalog number. Example: GV2ME013.

GV2, GV3, and GV7 Manual Motor Starters, Controllers, and Protectors Selection

Table 52: Electrical Trip Units

Description	Voltage	Hz	Catalog No. ^[1]	Weight, lb (kg)
Undervoltage or shunt trip units				
Side 1 block on right of GV2 or GV3 controllers	24	50	GVA•025	0.23 (0.105)
		60	GVA•026	
	48	50	GVA•055	
		60	GVA•056	
	100	50	GVA•107	
	100–110	60	GVA•107	
	110–115	50	GVA•115	
		60	GVA•116	
	120–127	50	GVA•125	
	127	60	GVA•115	
	200	50	GVA•207	
	200–220	60	GVA•207	
	220–240	50	GVA•225	
		60	GVA•226	
	380–400	50	GVA•385	
		60	GVA•386	
	415–440	50	GVA•415	
	415	60	GVA•416	
	440	60	GVA•385	
	480	60	GVA•415	
500	50	GVA•505		
600	60	GVA•505		
Undervoltage trip unit, conforming to INRS (can only be mounted on GV2ME)				
Safety device for dangerous machines, conforming to INRS and VDE 0113				
Side 1 block on right GV2ME controllers	110–115	50	GVAX115	0.24 (0.11)
		60	GVAX116	
	127	60	GVAX115	
	220–240	50	GVAX225	
		60	GVAX226	
	380–400	50	GVAX385	
		60	GVAX386	
	415–440	50	GVAX415	
	440	60	GVAX385	

¹ To order an undervoltage trip unit: replace the bullet (•) with a **U**, for example: **GVAU025**.
To order a shunt trip unit: replace the bullet (•) with an **S**, for example: **GVAS025**.

Table 53: Add-on Contact Blocks

Description	Mounting Location	Max. No. of Blocks	Catalog No.	Weight, lb (kg)
Visible isolation block ^[1]	Front ^[2]	1	GV2AK00	0.33 (0.150)
Limiters	At top (GV2ME and GV2P)	1	GV1L3	0.29 (0.130)
	Independent	1	LA9LB920	0.70 (0.320)

¹ Provides visible isolation of the 3 poles upstream of the **GV2P** controller.

² The mounting location of a **GV2AK00** visible isolation block on a **GV2P** controller (refer to Figure 1 on page 40).

Table 54: Fuse Holder, 30 A Maximum

For Use In	Terminal Description	For Fuse Type	Sold in Lots of	Catalog Number	Weight, lb (kg)
US Markets	Screw clamp, 3-pole	CC, KTK-R 0.41 x 1.5 (10.3 x 38 mm)	1	LS1D30	0.23 (0.50)
	Spring, 3-pole	CC, KTK-R 0.41 x 1.5 (10.3 x 38 mm)	1	LS1D303	
European Markets	Screw clamp, 3-pole	aM, gG 0.39 x 1.5 (10 x 38 mm)	1	LS1D32	
	Spring, 3-pole	aM, gG 0.39 x 1.5 (10 x 38 mm)	1	LS1D323	

GV2, GV3, and GV7 Manual Motor Starters, Controllers, and Protectors Selection

Table 55: Accessories for GV3P

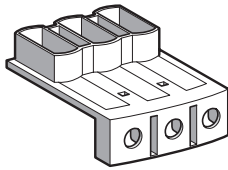

GV3G66

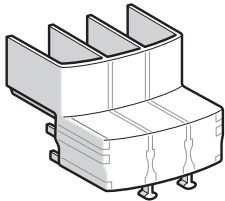

LAD96570

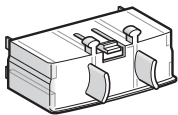

LAD96575

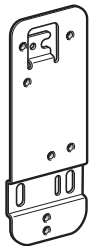

LAD7X3

Description	For Manual Motor Controllers	Catalog Number	Weight lb (kg)
3-pole, 115 A busbars Pitch 64 mm	2 tap-off	GV3G264 ^[1]	0.33 (0.15)
	3 tap-off	GV3G364 ^[1]	0.55 (0.25)
Cover, large spacing, UL 508 Type E (only one cover is required on the supply side)	GV3P**	GV3G66 ^[1]	0.44 (0.02)
IP20 cover (two covers are required for each manual starter and protector)	GV3P**6	LAD96570	0.46 (0.021)
IP20 cover for use when mounted with circuit breakers	GV3P**6	LAD96575	0.22 (0.01)
Padlocking device, for use with up to 4 padlocks (not supplied) Maximum shank Ø 6 mm	GV3P**	GV2V03	0.20 (0.09)
	GV3P**6		
Retrofit plate for screw mounting	To replace GV3ME with GV3P** or GV2P**	LAD7X3	0.33 (0.15)

¹ If the **GV3G66** add-on line terminal shroud is installed, the **GV3G** busbars cannot be installed.

GV2, GV3, and GV7 Manual Motor Starters, Controllers, and Protectors Selection

Figure 3: GV2 Accessories

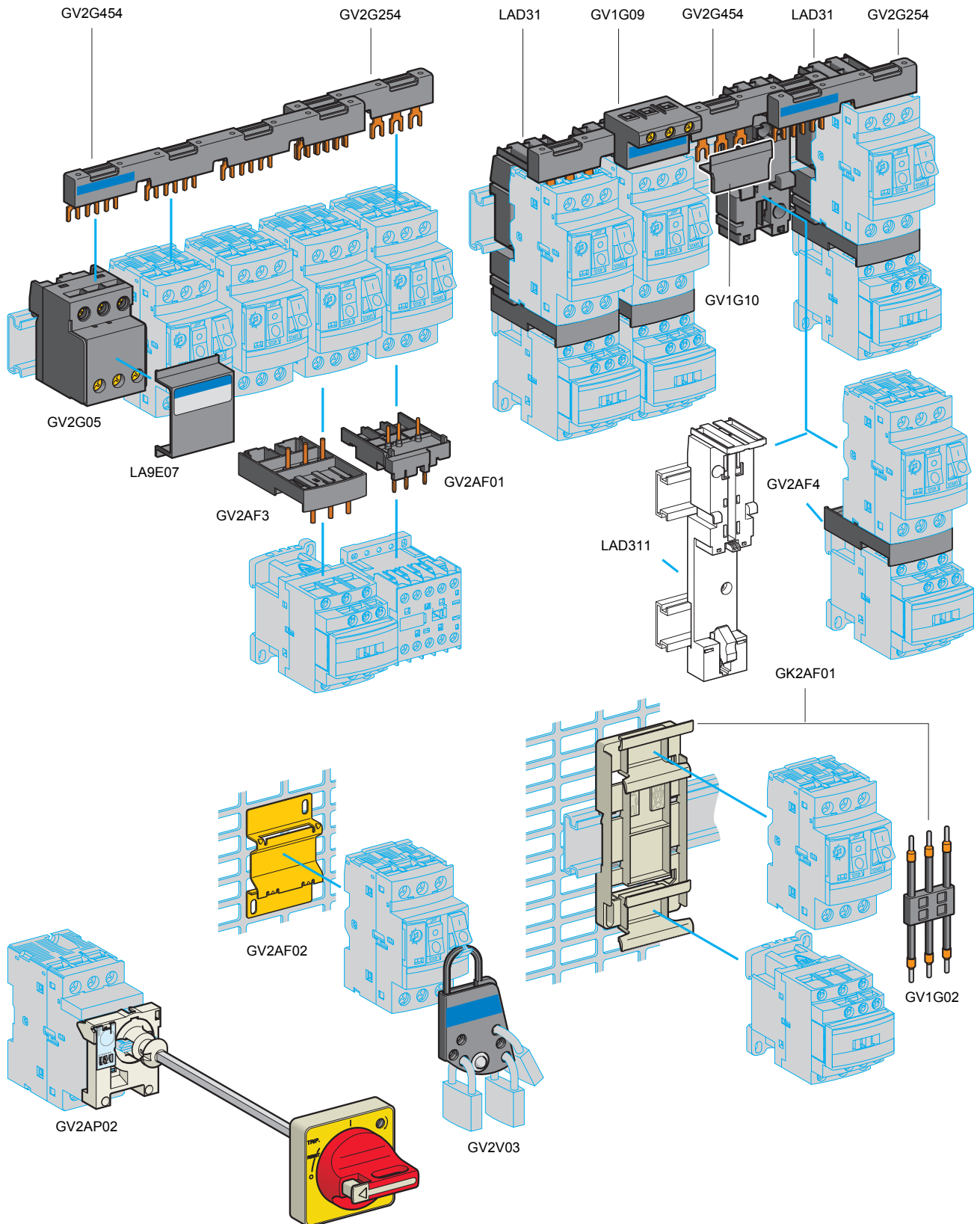

GV2, GV3, and GV7 Manual Motor Starters, Controllers, and Protectors Selection

Table 56: GV2 Accessories



GV2GH7



LAD31



LAD311

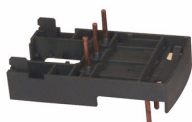

GV2AF3 / GV2AF4

Busbars						
Description	No. of GV Starters	No. of Side-Mounted Auxiliary Blocks on Each GV Starter	Busbar Pitch (mm)	Sold in Lots of	Catalog Number	Weight, lb (kg)
Sets of 3-pole, 63 A busbars	2	none	45	1	GV2G245	0.08 (0.036)
		1 GV2AN, AM, AD	54	1	GV2G254	0.084 (0.038)
		1 or 2 GV2AN, AM, AD; or 1 GV2AS, AU	72	1	GV2G272	0.09 (0.042)
	3	None	45	1	GV2G345	0.12 (0.058)
		1 GV2AN, AM, AD	54	1	GV2G354	0.13 (0.060)
	4	None	45	1	GV2G445	0.17 (0.077)
		1 GV2AN, AM, AD	54	1	GV2G454	0.19 (0.085)
		1 or 2 GV2AN, AM, AD; or 1 GV2AS, AU	72	1	GV2G472	0.21 (0.094)
	5	1 GV2AN, AM, AD	54	1	GV2G554	0.22 (0.100)

Additional GV2 Wiring Accessories				
Description	Application	Sold in Lots of	Catalog Number	Weight, lb (kg)
Protective end cover	For unused busbar outlets	5	GV1G10	0.01 (0.005)
Terminal blocks for supply to one or more GV2G+ busbar sets	Connects from the top	1	GV1G09	0.09 (0.040)
	Connects from the bottom. The connector can be fitted with a GV1L3 current limiter.	1	GV2G05	0.25 (0.115)
Cover for terminal block	For mounting in modular panels	10	LA9E07	0.01 (0.005)
Flexible 3-pole connector	For connecting a GV2 / LS1D30 to an LC1D09–D25 AC contactor	10	GV1G02	0.03 (0.013)
Clip-in marker holders (provided with each motor starter)	For GV2P, 0.31 x 0.87 in. (8 x 22 mm)	100	LA9D92	0.02 (0.001)
Incoming line insulator	For GV2P when used in UL 508 Type E applications	10	GV2GH7	0.09 (0.040)

GV2 Mounting Accessories				
Description	Application	Sold in Lots of	Catalog Number	Weight, lb (kg)
Motor starter adapter plate	With a 3-pole connector for mounting a GV2 controller to an LC1D09–D25 contactor	10	GK2AF01	0.26 (0.120)
Adapter plate	For screw mounting a GV2ME controller or an LS1D30 fuse holder	10	GV2AF02	0.05 (0.021)
	For mounting a GV2ME or GV2P controller to an LC1D09–LC1D32 contactor with front faces aligned	1	LAD31	0.09 (0.040)
Mounting bracket	For mounting a GV2ME or GV2P controller to an LC1D09–D38 contactor on a common base using 2 DIN rails	1	LAD311	0.09 (0.040)
7.5 mm height compensation plate	For mounting a GV2ME or GV2P controller on a common busbar	10	GV1F03	0.007 (0.003)
Combination block	Between a GV2ME controller or an LS1D30 fuse holder and a LC1K or LP1K contactor	10	GV2AF01	0.04 (0.021)
	Between a GV2 controller or an LS1D30 fuse holder and a LC1D09–D38 contactor	10	GV2AF3	0.03 (0.016)
	Between a GV2 controller or an LS1D30 fuse holder mounted on an LAD31 mounting plate and an LC1D09–D38 contactor	10	GV2AF4	0.03 (0.016)

GV2 Padlocking Options			
Description		Catalog Number	Weight, lb (kg)
Padlockable External Operator	Black handle, blue legend plate IP54	GV2AP01	0.44 (0.200)
	For GV2P controllers 6.0–11.4 in. (150–290 mm) Red handle, yellow legend plate IP54	GV2AP02	
Padlocking Device	Accommodates up to 6 padlocks (not supplied) Maximum shank Ø 6 mm	GV2V03	0.20 (0.092)

GV2, GV3, and GV7 Manual Motor Starters, Controllers, and Protectors Selection

Figure 4: GV2M Enclosures

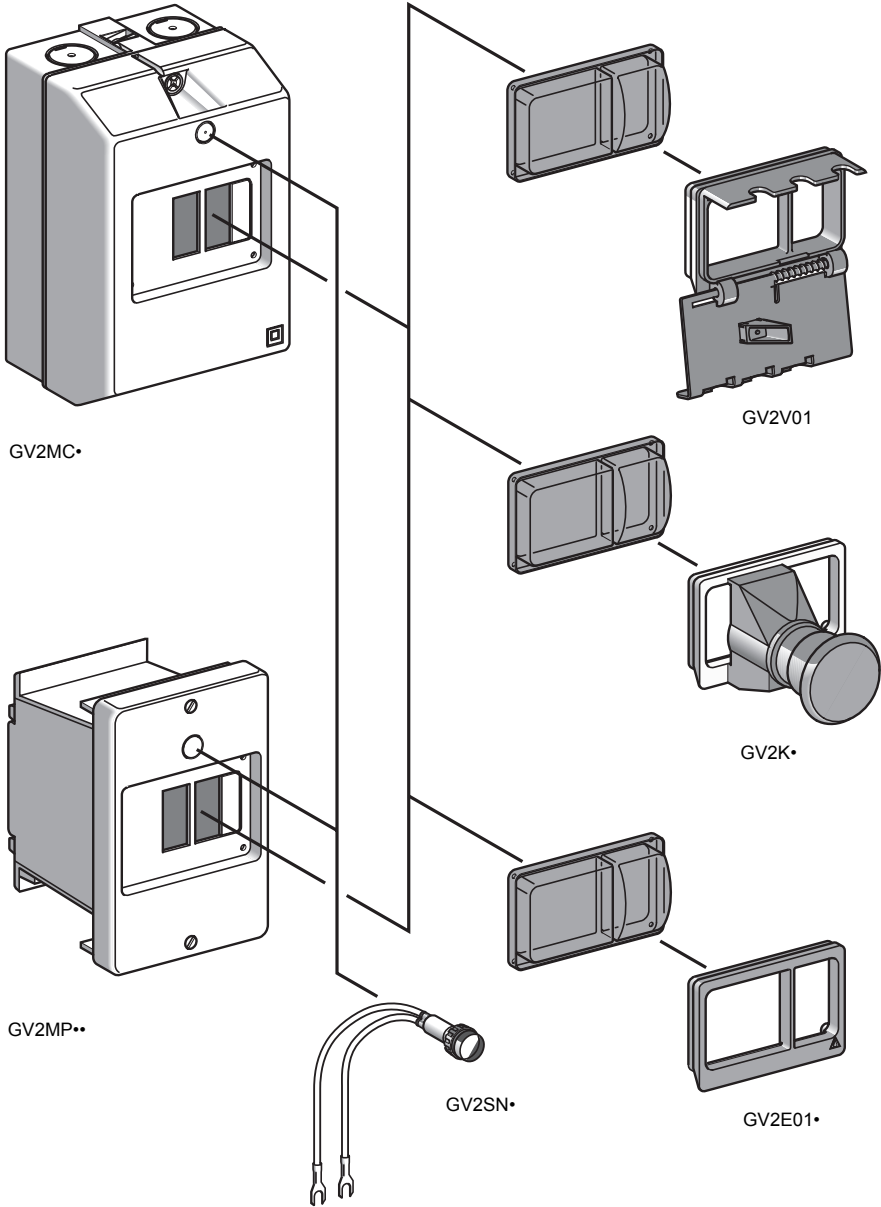

GV2, GV3, and GV7 Manual Motor Starters, Controllers, and Protectors Selection

Table 57: GV2ME Enclosures

Application	Type	Degree of Protection of Enclosure	Catalog Number	Weight, lb (kg)
For GV2ME manual starters and protectors, with or without accessories GV2MC, GV2MP01, and GV2MP02: Maximum of 1 accessory on the right and 1 on the left GV2MP03 and GV2MP04: 1 accessory on the right only	Surface mounting, double insulated with protective (sealable) cover	IP41	GV2MC01	0.64 (0.290)
		IP55	GV2MC02	0.66 (0.300)
		IP55 for temperature < 5 °C (41 °F)	GV2MC03	
	Flush, with protective cover	IP41 (full size) mounting	GV2MP01	0.25 (0.115)
		IP41 (reduced size)	GV2MP03	
		IP55 (full size)	GV2MP02	0.29 (0.130)
		IP55 (reduced size)	GV2MP04	

Table 58: GV2M Front Plate

Application		Sold in Lots of	Catalog Number	Weight, lb (kg)	
Padlocking device ^[1] for GV2M operator (padlocking is possible only in the Off position)		1	GV2V01	0.17 (0.075)	
Stop push button, mushroom head ^[1] Ø 40 mm, red	Spring return	1	GV2K011	0.11 (0.052)	
	Latching	Key release (key #455)	1	GV2K021	0.35 (0.160)
		Turn to release	1	GV2K031	0.25 (0.115)
	Latching/padlockable	Turn to release	1	GV2K04	0.26 (0.120)
Sealing kit	For enclosures and front plates	IP55	GV2E01		
		IP55 for temperature < 5 °C (41 °F)	GV2E02		
Neutral link		10	GV2N01	0.07 (0.030)	

Description	Voltage	Color	Sold in Lots of	Catalog Number	Weight, lb (kg)
Neon indicator light ^[2]	110 V	Green	10	GV2SN13	0.02 (0.01)
		Red	10	GV2SN14	
		Orange	10	GV2SN15	
	220/240 V	Green	10	GV2SN23	
		Red	10	GV2SN24	
		Orange	10	GV2SN25	
	380/440 V	Green	10	GV2SN33	
		Red	10	GV2SN34	
		Orange	10	GV2SN35	

¹ Includes the IP55 sealing kit.

² Leads are approximately 9.5 in. (260 mm).

**GV2, GV3, and GV7 Manual Motor Starters, Controllers, and Protectors
Selection**

GV2, GV3, and GV7 Manual Motor Starters, Controllers, and Protectors Selection

GV7 Accessories

Standard manual controllers and protectors include terminal- and device-mounting hardware. Select cable clamps and accessories from Table 59.

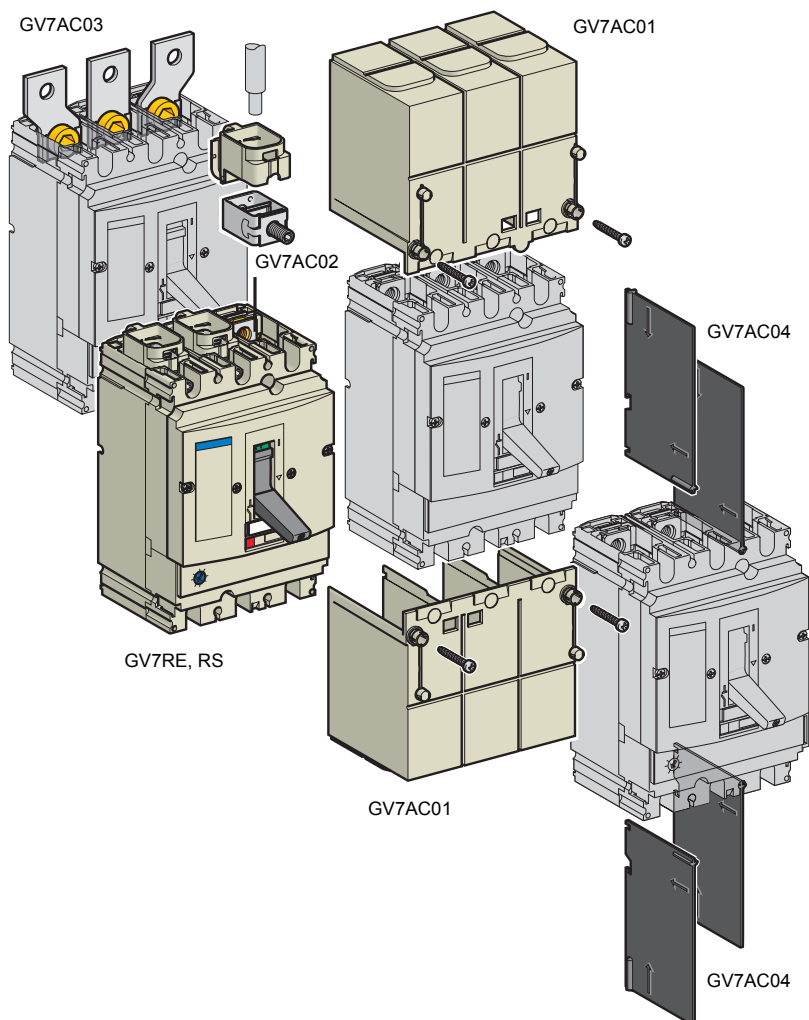

Table 59: Cabling Accessories

Description	Application	Sold in Lots of	For Contactor	Catalog Number	Weight, lb (kg)
Box lugs	GV7R•40 through GV7R•150: 14–3/0 AWG (1.5–95 mm ²)	3	—	GV7AC021	0.66 (0.300)
	GV7R•220: 14 AWG–350 mcm (1.5–185 mm ²)	3	—	GV7AC022	0.77 (0.350)
Phase Barriers, Busbars, and Shrouds					
Terminal extension kit	Increases the centerline distance between phases to 45 mm	3	—	GV7AC03	0.40 (0.180)
Terminal shroud kit ^[1]	Covers the terminal connections; is finger safe per IEC 60529	1	—	GV7AC01	0.28 (0.125)
Phase barriers ^[1]	Provides maximum phase separation at the connection points	2	—	GV7AC04	0.17 (0.075)
Insulating barriers	Provides insulation between the connections and the backplate	2	—	GV7AC05	
Busbars and covers ^[2]	Provides a direct link between the GV7 manual motor starter and the contactor. The cover protects against direct finger contact.				
	Connect to LC1F115–185 contactor	1	LC1F115 to F185	GV7AC06	1.21 (0.550)
	Connect to LC1F225–265 contactor	1	LC1F225 and F265	GV7AC07	
Connect to LC1D115–150 contactor	1	LC1D115 and D150	GV7AC08		

¹ Terminal shields cannot be used together with phase barriers.

² The kit contains links, a protective shield, and an adjustable-depth metal bracket for the protector.

GV2, GV3, and GV7 Manual Motor Starters, Controllers, and Protectors Selection

Auxiliary Contacts

Auxiliary contacts remotely indicate the state of the contacts in the starter. The auxiliary contacts can be used for signaling, electrical locking, or relaying. Standard and low-level versions are available. The auxiliary contacts include a terminal block. A hole is provided for wiring exit.

An auxiliary contact can perform any of the functions listed in Table 60, depending on where the contact is located in the starter.

Figure 5: Auxiliary Contact Locations

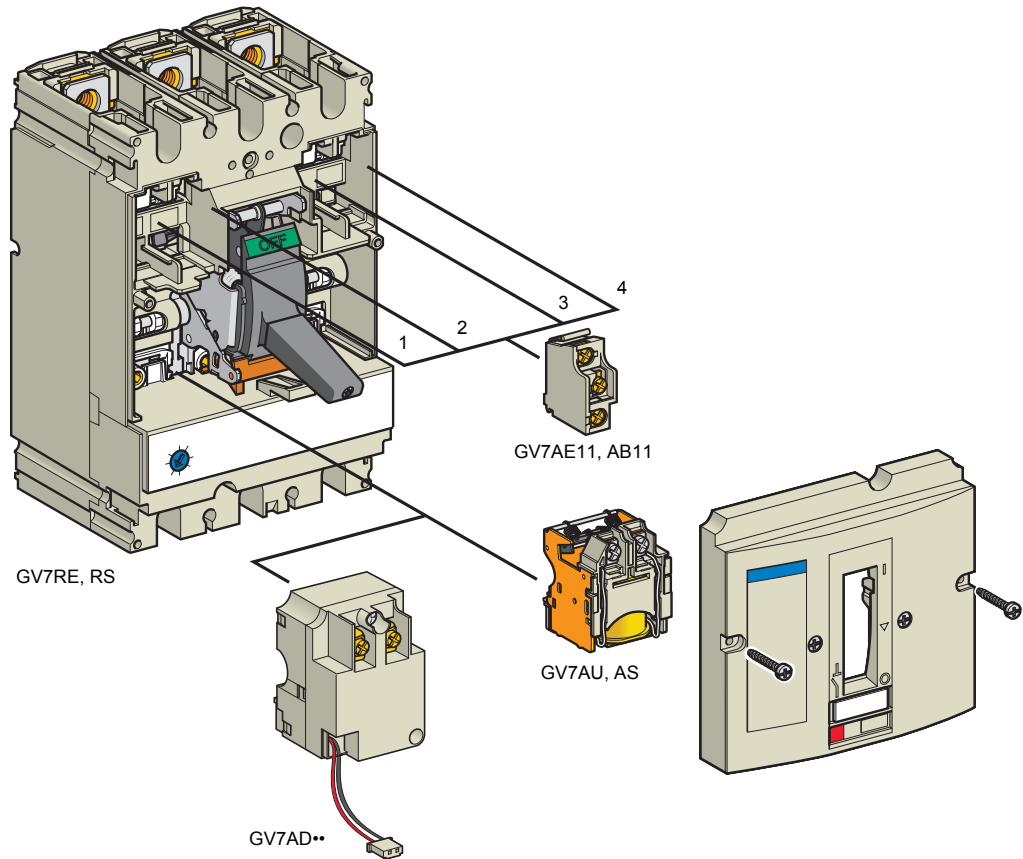

Table 60: Auxiliary Contact Location and Function

Location	Function	Application
1	N.O./N.C. contact	Indicates the position of the starter poles.
2	Trip indicator	Indicates that the starter has tripped due to an overload, short circuit, differential fault condition, the operation of a voltage release (undervoltage or shunt release), or from pressing the push-to-trip button. The trip indicator resets when the starter is reset.
3	Electrical fault indicator	Indicates that the starter has tripped due to an overload, short circuit, or differential fault. The electrical fault indicator resets when the starter is reset.
4	N.O./N.C. contact	Indicates the position of the starter poles.

Table 61: Auxiliary Contacts

Type	Voltage	Catalog Number	Weight, lb (kg)
Standard	—	GV7AE11	0.03 (0.015)
Low level	—	GV7AB11	

GV2, GV3, and GV7 Manual Motor Starters, Controllers, and Protectors Selection

Magnetic Fault Indicators

The magnetic fault indicator does one of the following:

- differentiates a thermal fault from a magnetic fault
- opens the contactor only in the event of a thermal fault (see page 50)

Table 62: Magnetic Fault Indicators

Voltage	Catalog Number	Weight, lb (kg)
24–48 Vac / 24–72 Vdc	GV7AD111	0.22 (0.100)
110–240 Vac/Vdc	GV7AD112	

Undervoltage Trip Units, GV7AU

The undervoltage trip opens the motor starter when the control voltage drops below the trip threshold of 0.35–0.7 times the rated voltage. The starter contacts close again when the control voltage rises above 0.85 times the rated voltage. The GV7AU undervoltage trip unit meets the requirements of IEC 60947-2. For the location of the undervoltage trip unit, see Figure 5 on page 50.

Shunt Trip Units, GV7AS

The shunt trip opens the motor starter when the control voltage rises above 0.7 times the rated voltage. For location of the shunt trip unit, see Figure 5 on page 50.

Trip Unit Operation, GV7AU or GV7AS

When the motor starter has been tripped by a GV7AU or AS trip unit, it must be reset either locally or by remote control. For information on remote control, consult your local sales office.

Tripping has priority over manual closing. When a trip condition is present, manual action does not close the contacts, even temporarily.

Table 63: Undervoltage Trip and Shunt Trip Devices

Type	Voltage	Catalog Number	Weight, lb (kg)
Undervoltage trip	48 V, 50 Hz	GV7AU055	0.23 (0.105)
	110–130 V, 50/60 Hz	GV7AU107	0.24 (0.110)
	200–240 V, 50/60 Hz	GV7AU207	
	380–440 V, 50/60 Hz	GV7AU387	0.23 (0.105)
	525 V, 50 Hz	GV7AU525	0.22 (0.100)
Shunt trip	48 V, 50 Hz	GV7AS055	0.23 (0.105)
	110–130 V, 50/60 Hz	GV7AS107	0.24 (0.110)
	200–240 V, 50/60 Hz	GV7AS207	
	380–440 V, 50/60 Hz	GV7AS387	0.23 (0.105)
	525 V, 50 Hz	GV7AS525	0.22 (0.100)

GV2, GV3, and GV7 Manual Motor Starters, Controllers, and Protectors Selection

Figure 6: GV7R Starter with Options and Accessories

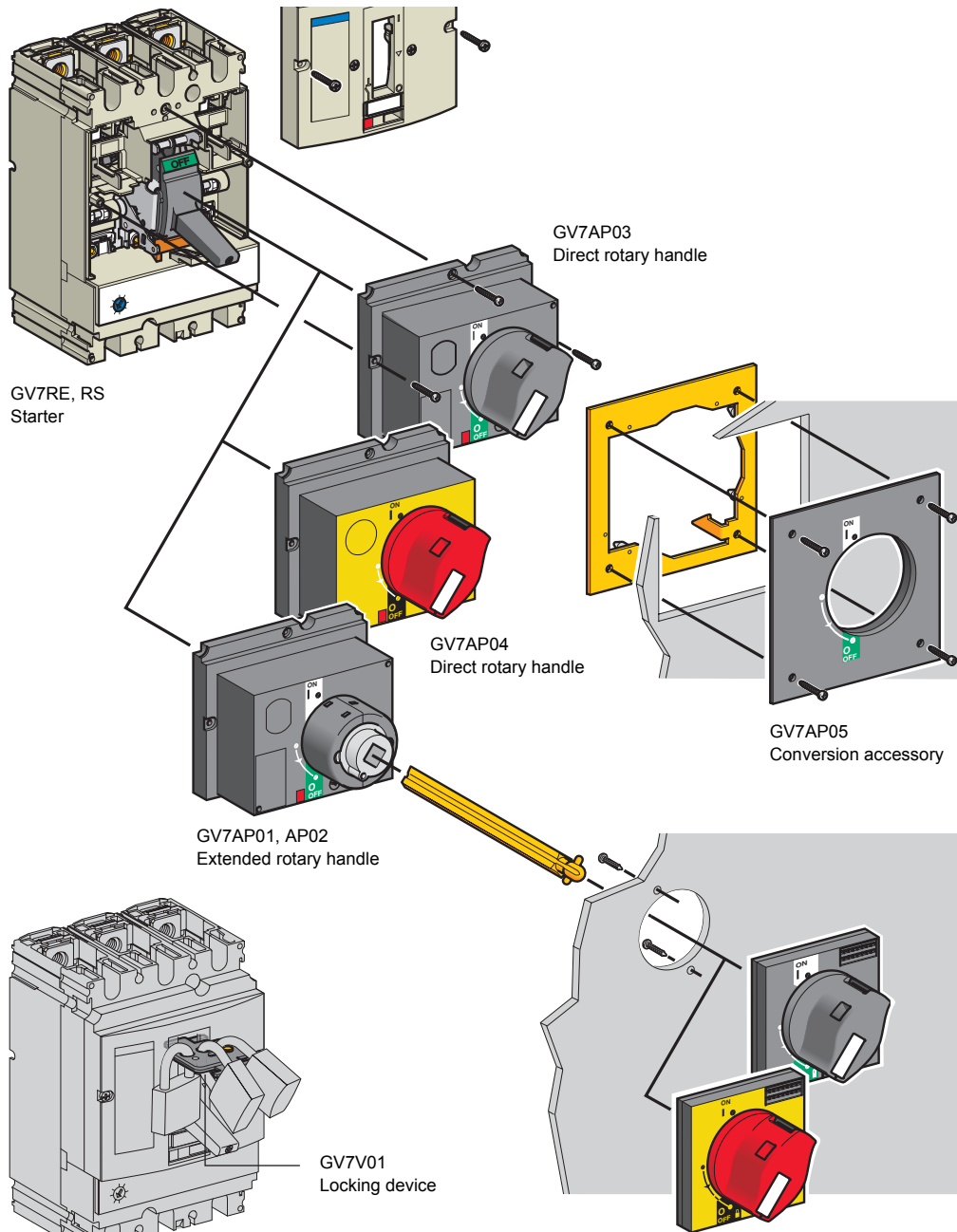

GV2, GV3, and GV7 Manual Motor Starters, Controllers, and Protectors Selection

Direct Rotary Handle

The direct rotary handle accessory replaces the front cover of the starter and is secured by screws. Refer to Figure 6 on page 52. The handle includes a device for padlocking the starter in the Off (O) position. As many as three padlocks with a shank diameter of 5–8 mm (0.2–0.3 in.) can be used. The padlocks are not supplied. The conversion accessory allows the direct rotary handle to be mounted on an enclosure door. This accessory is designed to prevent the opening of the door when the manual motor starter is in the ON position.

Table 64: Direct Rotary Handle

Description	Type	Catalog Number	Weight, lb (kg)
Direct rotary handle	Black handle, black legend plate	GV7AP03	0.45 (0.205)
	Red handle, yellow legend plate	GV7AP04	
Conversion accessory	For mounting the direct rotary handle onto the enclosure door	GV7AP05	0.22 (0.100)

Extended Rotary Handle

The extended rotary handle makes it possible for a door-mounted rotary handle to operate controllers installed on the inside back panel of an enclosure. Refer to Figure 6 on page 52. The extended rotary handle consists of the following:

- a unit that screws onto the front cover of the starter
- an assembly (handle and front plate) that fits on the enclosure door
- an extension shaft which must be adjusted according to the distance between the mounting surface and the door: 185 mm (7.28 in.) minimum, 600 mm (23.62 in.) maximum

The extended rotary handle includes a device for padlocking the starter in the Off (O) position. As many as three padlocks with a shank diameter of 5–8 mm (0.2–0.3 in.) can be used. The padlocks are not supplied. Using the padlocks prevents the enclosure door from being opened.

Table 65: Extended Rotary Handle

Description	Type	Catalog Number	Weight, lb (kg)
Extended rotary handle	Black handle, black legend plate	GV7AP01	1.71 (0.775)
	Red handle, yellow legend plate	GV7AP02	

Locking Device

The locking device allows controllers with no rotary handle installed to be padlocked in the Off (O) position. As many as three padlocks with a shank diameter of 5–8 mm (0.2–0.3 in.) can be used. The padlocks are not supplied. Refer to Figure 6 on page 52.

Table 66: Locking Device

Description	Application	Catalog Number	Weight, lb (kg)
Locking device	GV7 starters without a rotary handle	GV7V01	0.22 (0.100)

Environment

Table 67: IP Ratings for Manual Motor Starters

Type	GV2ME	GV2P	GV3P	GV3ME80	GV7R
Degree of protection					
Conforming to IEC 60529 open mounted	IP20	IP20	IP20	IP20	IP405 with terminal shrouds

GV2, GV3, and GV7 Manual Motor Starters, Controllers, and Protectors

Mounting Dimensions and Wiring Diagrams

Mounting Dimensions and Wiring Diagrams

GV2 Mounting Dimensions

GV2ME	GV2AD, AM AN, AU, AS, AX	GV2AE	LS1D30

X1 Electrical clearance = 1.8 in. (40 mm) for $U_e \leq 690$ V

GV2P	GV2AD, AM, AN, AU, AS	GV2AK00

X2 = 1.8 in. (40 mm)

X1 Electrical clearance = 1.8 in. (40 mm) for $U_e \leq 415$ V, or 3.2 in. (80 mm) for $U_e = 440$ V, or 4.7 in. (120 mm) for $U_e = 500$ and 690 V

Mounting of GV2M

On 35 mm (1.4 in.) Rail	On Panel with Adapter Plate, GV2AF02	On Pre-Slotted Mounting Plate, AM1PA	On Mounting Rail, DZ5MB201

C = 78.5 on AM1DP200 (35 x 7.5)

C = 86 on AM1DE200, ED200 (35 x 15)

GV2, GV3, and GV7 Manual Motor Starters, Controllers, and Protectors

Mounting Dimensions and Wiring Diagrams

Mounting of GV2P			
On 35 mm (1.4 in.) Rail	On Panel	On Pre-Slotted Mounting Plate, AM1PA	On Adapter Plate, GK2AF01
<p>C = 3.09 in. (78.5 mm) on AM1DP200 (35 x 7.5 mm) C = 3.39 in. (86 mm) on AM1DE200, ED200 (35 x 15 mm)</p>			

GV2AF01 GV2M + K contactor combination	GV2M and GV1L3 current limiter	GV1F03 7.5 mm height compensation plate
		<p style="text-align: center;">Dimensions: $\frac{\text{in.}}{\text{mm}}$</p>
<p>X1 = 0.40 in. (10 mm) for Ue = 230 V or 1.2 in. (30 mm) for 230 V < Ue ≤ 690 V</p>		

GV2AF4 and LAD31					
Combination GV2ME and D range contactor			Combination GV2P and D range contactor		
		<p>Dimensions: $\frac{\text{in.}}{\text{mm}}$</p>			<p>Dimensions: $\frac{\text{in.}}{\text{mm}}$</p>
GV2ME +	LC2D09 to D18	LC2D25 and D32	GV2P +	LC2D09 to D18	LC2D25 and D32
b	7.4 (188.6)	7.8 (199)	b	6.61 (169.1)	7.9 (199.5)
c1	3.6 (92.7)	3.9 (99)	c1	4.6 (116.8)	4.6 (116.8)
c	3.9 (98.2)	4.11 (104.5)	c	4.8 (122.3)	4.8 (122.3)
d1	3.9 (98.3)	3.9 (98.3)			
d	4.1 (103.8)	1.4 (103.8)			

GV2, GV3, and GV7 Manual Motor Starters, Controllers, and Protectors

Mounting Dimensions and Wiring Diagrams

Mounting of External Operator GV2AP01 or GV2AP02

Door Cut-out

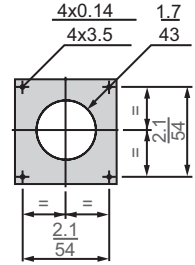
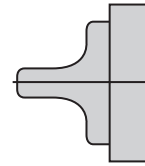
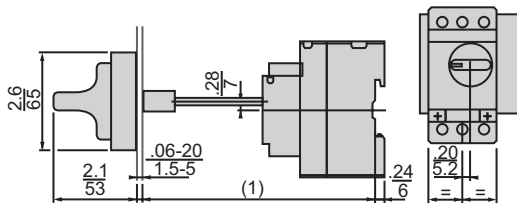

1. 135 mm minimum, 284 mm maximum with operating rod uncut, 88 with operating rod cut.

Surface Mounting Enclosure GV2MC0•

Front Plate GV2CP21

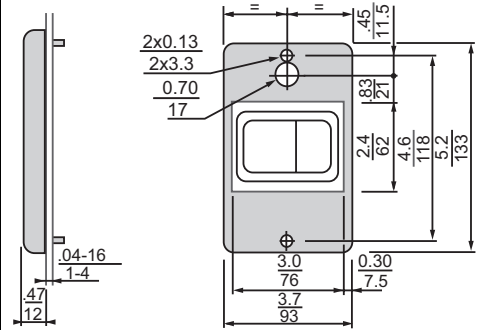
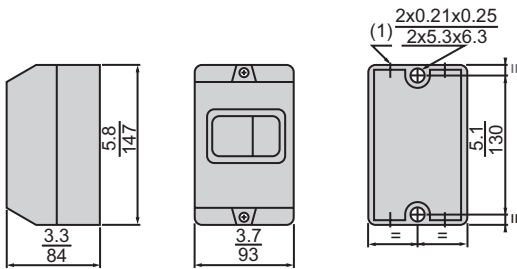

1. 4 knock-outs for 0.63 in. (16 mm) plastic cable entries or n° 16 conduit

Flush Mounting Enclosure GV2MP0• (bracket cut-out dimensions)

GV2MP0•

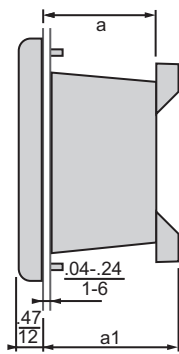

GV2MP01, MP02

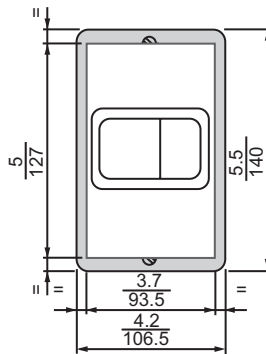

GV2MP03

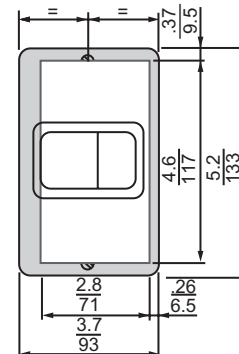

GV2	a	a1
MP01, MP02	2.8 in. (71 mm)	—
MP03, MP04	—	3.4 in. (86 mm)

Dimensions: $\frac{\text{in.}}{\text{mm}}$

GV2, GV3, and GV7 Manual Motor Starters, Controllers, and Protectors Mounting Dimensions and Wiring Diagrams

Sets of Busbars GV2G445, GV2G454, and GV2G472 with Terminal Block GV2G05

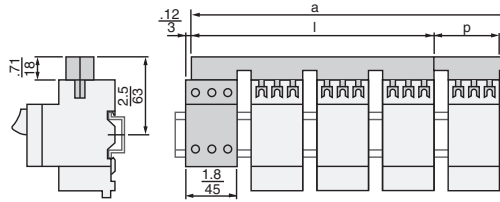

		l	p
GV2G454	0.16 x 2.1 in. (4 x 54 mm)	8.1 in. (206 mm)	2.1 in. (54 mm)
GV2G445	0.16 x 1.8 in. (4 x 45 mm)	7.0 in. (179 mm)	1.8 in. (45 mm)
GV2G472	0.16 x 2.8 in. (4 x 72 mm)	10.2 in. (260 mm)	2.8 in. (72 mm)

No. of Taps	a			
	5	6	7	8
GV2G454	10.2 in. (260 mm)	12.4 in. (314 mm)	14.5 in. (368 mm)	16.6 in. (422 mm)
GV2G445	8.8 in. (224 mm)	10.6 in. (269 mm)	12.4 in. (314 mm)	14.1 in. (359 mm)
GV2G472	13.1 in. (332 mm)	15.9 in. (404 mm)	18.7 in. (476 mm)	21.6 in. (548 mm)

Sets of Busbars with Terminal Block GV1G09

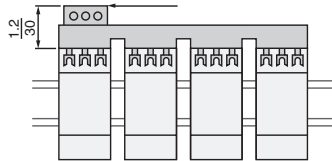

Sets of Busbars GV2G245, GV2G254, and GV2G272

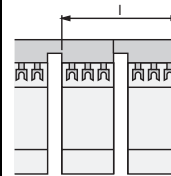

	l	
GV2G254	0.08 x 2.1 in. (2 x 54 mm)	3.9 in. (98 mm)
GV2G245	0.08 x 1.8 in. (2 x 45 mm)	3.5 in. (89 mm)
GV2G272	0.08 x 2.8 in. (2 x 72 mm)	4.6 in. (116 mm)

Set of Busbars GV2G554

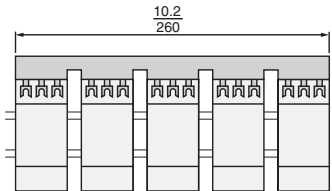

Set of Busbars GV2G354

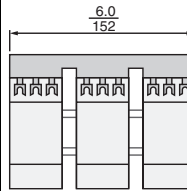

GV2, GV3, and GV7 Manual Motor Starters, Controllers, and Protectors

Mounting Dimensions and Wiring Diagrams

GV3 Mounting Dimensions

Dimensions

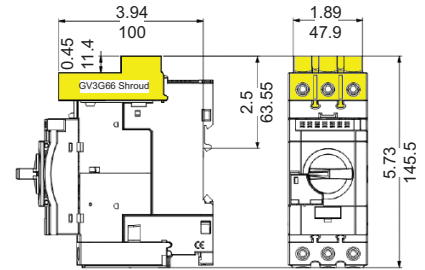
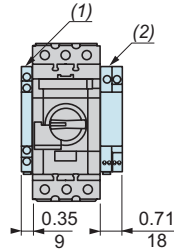
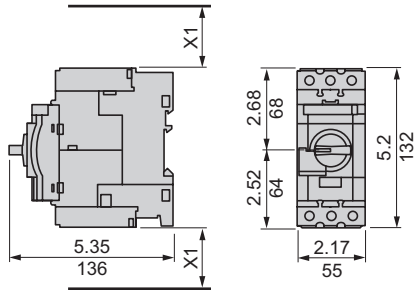

X1 = Electrical clearance (ISC max)
40 mm for $U_e < 500$ V, 50 mm for $U_e < 690$ V

1. Blocks GVAN●●, GVAD●● and GVAM11
2. Blocks GV3AU●● and GV3AS●●

The GV3G66 add-on line terminal shroud must be installed on the GV3P for it to meet UL 508 Type E requirements for standalone applications. The shield snaps into place on the line side of the GV3P.

NOTE: Between two manual motor starters, leave a 9 mm gap, either an empty space or side-mounting add-on contact blocks. Horizontal mounting is possible up to 40 °C.

NOTE: If the GV3G66 add-on line terminal shroud is installed, the GV3G busbars **cannot** be installed.

Mounting

Mounting with TeSys Contactor LC1D40A–D65A

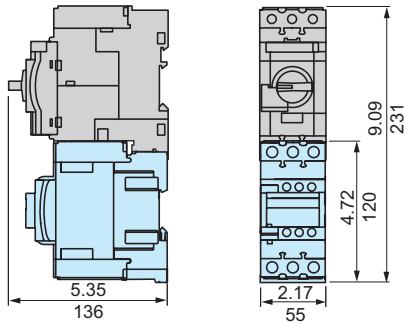

Side-by-Side Mounting (S-shape Busbar System GV3S)

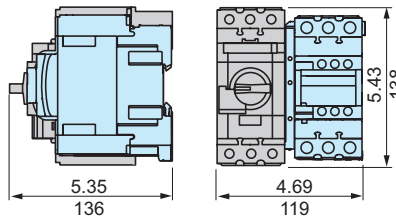

Mounting on Rail AM1DE200 or AM1ED201

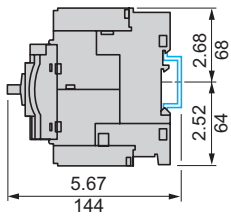

Panel Mounting, using M4 Screws

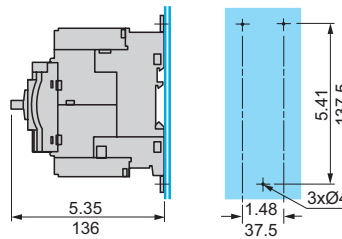

Mounting on Pre-Slotted Plate AM1 PA

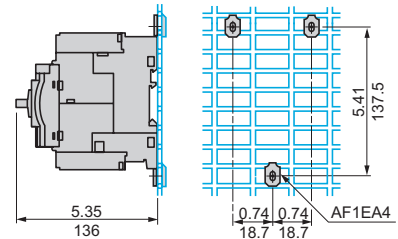

Busbar Systems

Set of Busbars GV3G264

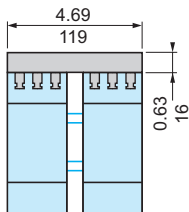

Set of Busbars GV3 G364

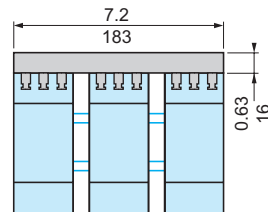

Dimensions: $\frac{\text{in.}}{\text{mm}}$

NOTE: Between two manual motor starters, leave a 9 mm gap, either an empty space or side-mounting add-on contact blocks. Horizontal mounting is possible up to 40 °C.

NOTE: If the GV3G66 add-on line terminal shroud is installed, the GV3G busbars **cannot** be installed.

GV2, GV3, and GV7 Manual Motor Starters, Controllers, and Protectors Mounting Dimensions and Wiring Diagrams

GV7 Mounting Dimensions

Motor Controllers GV7R	Motor Controllers with Terminal Shields and Phase Barriers GV7R + GV7AC01 + GV7AC04
1. 126 for GV7R• 220	2. Phase barriers—GV7AC04 3. Terminal shields—GV7AC01

Safety Clearance

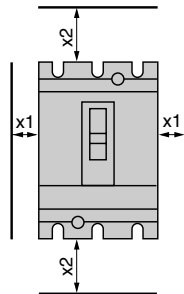

	x1	x2
	in. (mm)	in. (mm)
Painted or insulated metal plate, insulation, or insulated bar	0 (0)	1.18 (30)
Bare metal plate	$U \leq 440 \text{ V}$	0.20 (5)
	$440 \text{ V} < U < 600 \text{ V}$	0.39 (10)
	$U \geq 600 \text{ V}$	0.79 (20)

Minimum distance between two manual motor starters mounted side by side = 0.

Combination of GV7 and LC1F with Kit GV7AC0•

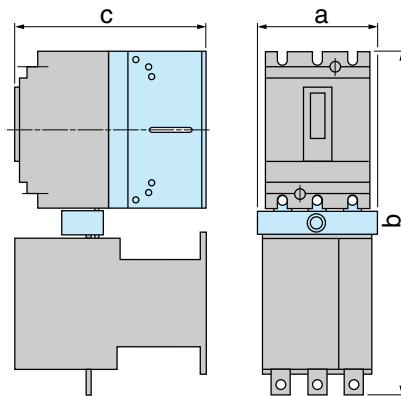

	in. (mm)		
	a	b	c
GV7R + LC1F115 or F150 + GV7AC06	4.69 (119)	13.15 (334)	7.13 (181)
GV7R + LC1F185 + GV7AC06	4.69 (119)	13.31 (338)	7.40 (188)
GV7R + LC1F225 + GV7AC07	5.16 (131)	14.09 (358)	7.40 (188)
GV7R + LC1F265 + GV7AC07	5.12 (130)	14.33 (364)	8.46 (215)

Dimensions: $\frac{\text{in.}}{\text{mm}}$

GV2, GV3, and GV7 Manual Motor Starters, Controllers, and Protectors

Mounting Dimensions and Wiring Diagrams

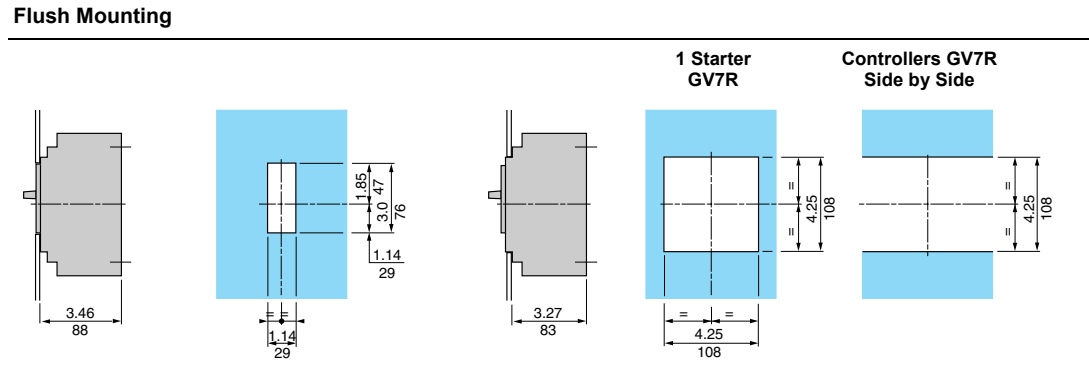
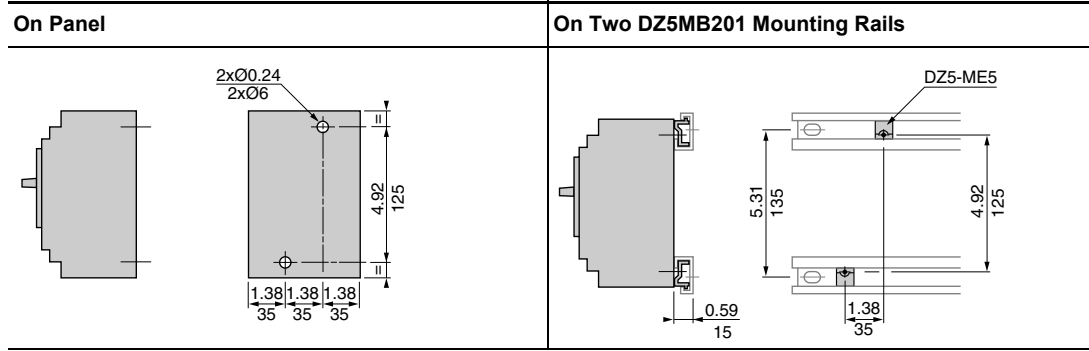

Combination of GV7R and LC1F with Kit GV7AC0•

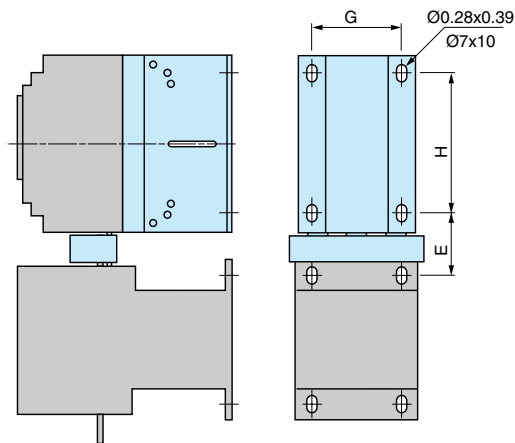

	in. (mm)		
	E	G	H
GV7R + LC1F115 + GV7AC06	1.73 (44)	3.35 (85)	4.72 (120)
GV7R + LC1F150 + GV7AC06	1.81 (46)	3.35 (85)	4.72 (120)
GV7R + LC1F165 + GV7AC06	1.89 (48)	3.35 (85)	4.72 (120)
GV7R + LC1F225 + GV7AC07	2.24 (57)	3.35 (85)	4.72 (120)
GV7R + LC1F265 + GV7AC07	2.36 (60)	3.35 (85)	4.72 (120)

Dimensions: $\frac{\text{in.}}{\text{mm}}$

GV2, GV3, and GV7 Manual Motor Starters, Controllers, and Protectors

Mounting Dimensions and Wiring Diagrams

Spreaders GV7AC03	Cabling	Smooth Terminals	Connectors

	a
GV7R•	0.77 in. (19.5 mm)
GV7R•220	0.85 in. (21.5 mm)

Direct Rotary Handle GV7AP03, GV7AP04	Flush Mounting

Direct Rotary Handle GV7AP03 or GV7AP04 with conversion accessory GV7AP05	Front Fuse Center	Enclosure viewed from Top
		<p>Door cutouts require a minimum distance between the center of the manual motor starter and the door hinge point: $d \geq 3.94 \text{ in. (100 mm) + (h x 5)}$.</p>

Extended Rotary Handle GV7AP01, GV7AP02
<p>L: 7.28 in. (185 mm) minimum, 23.62 in. (600 mm) maximum.</p> <p style="text-align: right;">Dimensions: $\frac{\text{in.}}{\text{mm}}$</p>

GV2, GV3, and GV7 Manual Motor Starters, Controllers, and Protectors

Mounting Dimensions and Wiring Diagrams

GV2 Wiring Diagrams

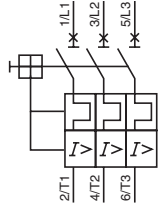
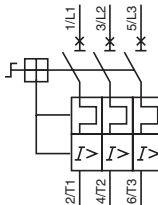
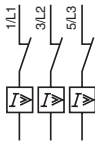
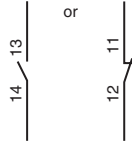
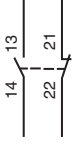
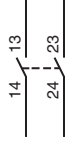
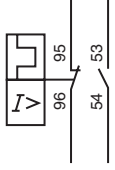
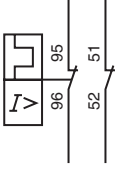
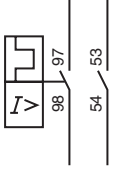
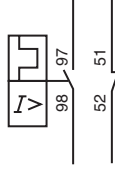
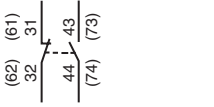
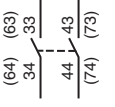
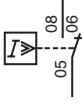
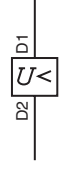
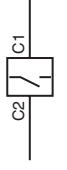
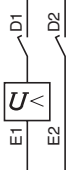
<p>GV2ME</p> 	<p>GV2P</p> 	<p>Current Limiter GV1L3</p> 	
<p>Front Mounting Add-on Contact Blocks Instantaneous Auxiliary Contacts</p>			
<p>GVAE1</p> 	<p>GVAE11</p> 	<p>GVAE20</p> 	
<p>Side Mounting Add-on Contact Blocks Instantaneous Auxiliary Contact and Fault Signaling Contacts</p>			
<p>GVAD0110</p> 	<p>GVAD0101</p> 	<p>GVAD1010</p> 	<p>GVAD1001</p> 
<p>Instantaneous Auxiliary Contacts</p>			
<p>GVAN11</p> 	<p>GVAN20</p> 	<p>GVAM11</p> 	
<p>Voltage Trip Units</p>			
<p>GVAU</p> 	<p>GVAS</p> 	<p>GVAX...</p> 	

GV2, GV3, and GV7 Manual Motor Starters, Controllers, and Protectors Mounting Dimensions and Wiring Diagrams

Use of Fault Signaling Contact and Short-Circuit Signaling Contact

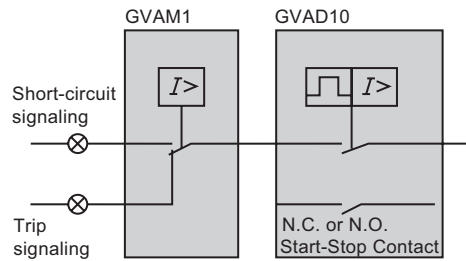
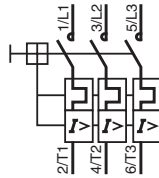

Table 68: GV3 Wiring Diagrams

Manual Motor Starter

GV3P



Auxiliary Contact Blocks

GV3A01



GV3A02



GV3A03

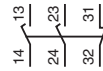

GV3A05

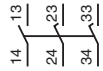

GV3A06

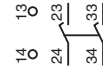

GV3A07

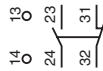

Fault Signaling Contacts

GV3A08

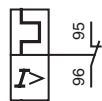

GV3A09

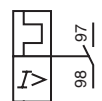

Voltage Trip Units

GV3B••







GV3D••

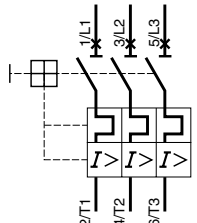

GV2, GV3, and GV7 Manual Motor Starters, Controllers, and Protectors

Mounting Dimensions and Wiring Diagrams

Table 69: GV7 Wiring Diagrams

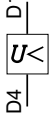
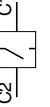
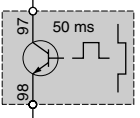
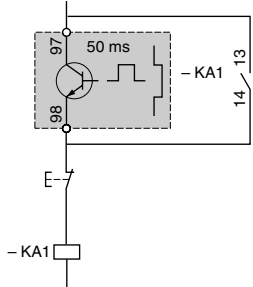
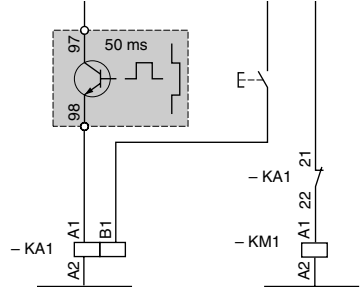
Motor Controllers GV7R	Add-on Auxiliary Contacts GV7AE11, GV7AB11	
	<div style="display: flex; justify-content: space-around; align-items: flex-start;"> <div style="text-align: center;">  </div> <div style="text-align: center;">  </div> <div style="text-align: center;">  </div> <div style="text-align: center;">  </div> </div> <p data-bbox="678 493 1477 548">A self-adhesive label, supplied with the contact, can be affixed to the front face of the starter to allow personalized marking as a function of the contact or contacts.</p>	
Electrical Trip Units GV7AU••	GV7AS•••	GV7AD111, AD112
		
		

GV2, GV3, and GV7 Manual Motor Starters, Controllers, and Protectors

GV2, GV3, and GV7 Manual Motor Starters, Controllers, and Protectors

GV2, GV3, and GV7 Manual Motor Starters, Controllers, and Protectors

Schneider Electric USA, Inc.

8001 Knightdale Blvd.
Knightdale, NC 27545
1-888-Square D
1-888-778-2733
www.schneider-electric.us

2520CT0001R04/09 © 2001–2010 Schneider Electric All Rights Reserved
Replaces 2520CT0001R9/02 dated October 2002