



**CONNECT AND PROTECT**

# Fixing Fastening & Support Products

For HVAC, Plumbing, Refrigeration,  
Fire Protection & Seismic Applications

  
**nvent**



**CADDY**



## CADDY

Just as every idea begins with a spark, we at nVent view the dawn of every sunrise as a new opportunity to ignite innovation. Our inventive solutions benefit customers around the world every day, keeping lights on, data streaming and trains running on time.

From heat trace cables to critical equipment enclosures to labor-efficient fastening systems, we empower customers to improve performance, lower costs and reduce downtime.

We are a \$2.2 billion, high-performance electrical company with a dedicated team of 9,400 people and trusted brands such as nVent CADDY, ERICO, HOFFMAN, RAYCHEM, SCHROFF and TRACER. Known for innovation, quality and reliability, our products connect and protect, consistently delivering value to industrial, commercial, residential, energy and infrastructure customers.

While our name may be new, our products have set the standards for quality for more than a century. Today as nVent, we are focused and forward-looking, ready to build upon our legacy. The future is now.

# TABLE OF CONTENTS

Featured Products .....	<b>A</b>
Product Application Reference .....	<b>B</b>
Product Picture Reference .....	<b>C</b>
Clevis Hangers.....	<b>1-1 - 1-6</b>
Loop- & J-Hangers .....	<b>2-1 - 2-8</b>
Split Ring Hangers .....	<b>3-1 - 3-6</b>
Riser Clamps .....	<b>4-1 - 4-6</b>
Pipe Fixings .....	<b>5-1 - 5-12</b>
Pipe Fixings – CPVC.....	<b>6-1 - 6-6</b>
Strut Clamps .....	<b>7-1 - 7-10</b>
nVent CADDY Rod Lock.....	<b>8-1 - 8-16</b>
Structural Attachments – Beam .....	<b>9-1 - 9-20</b>
Structural Attachments – Deck.....	<b>10-1 - 10-4</b>
Structural Attachments – Wall/Ceiling .....	<b>11-1 - 11-6</b>
Structural Attachments – Concrete Inserts .....	<b>12-1 - 12-4</b>
Shields and Saddles .....	<b>13-1 - 13-18</b>
Rollers and Stands.....	<b>14-1 - 14-10</b>
In-Wall Fasteners .....	<b>15-1 - 15-4</b>
Ceiling/Acoustical.....	<b>16-1 - 16-4</b>
Threaded Rod Hangers .....	<b>17-1 - 17-24</b>
Strap Hangers.....	<b>18-1 - 18-4</b>
nVent CADDY Pyramid Rooftop Supports.....	<b>19-1 - 19-26</b>
nVent CADDY Speed Link System.....	<b>20-1 - 20-26</b>
Rigid Bracing System .....	<b>21-1 - 21-20</b>
Cable Bracing System.....	<b>22-1 - 22-8</b>
Branch Line Restraint System.....	<b>23-1 - 23-4</b>
Bracing Accessories .....	<b>24-1 - 24-4</b>
Hardware .....	<b>25-1 - 25-12</b>
Anchors.....	<b>26-1 - 26-8</b>
nVent CADDY Eristrut.....	<b>27-1 - 27-32</b>
Technical information .....	<b>D</b>
Index .....	<b>E</b>



Click any product part number for more details via our online catalog at [nVent.com](http://nVent.com)



Click the video icon to watch installation or product videos containing those products

## DESIGNS

All dimensions are  $\pm 5\%$  and product design and specifications are subject to change without notice.

## DESIGN AND MANUFACTURING

Supports and hangers may be manufactured in conformance with one or more of the following:

Manufacturers Standardization Society MSS-SP-58

Federal Specification WW-H-171

Factory Mutual Research Corporation

Underwriters Laboratories, Inc.

National Fire Protection Association NFPA®-13 , NFPA 24

ANSI Code for Pressure Piping

## TERMS AND CONDITIONS OF SALE

For ordering, terms and conditions of sale, please consult our current price guide.

## WARNING

nVent products shall be installed and used only as indicated in nVent's product instruction sheets and training materials. Instruction sheets are available at [nVent.com/CADDY](http://nVent.com/CADDY) and from your nVent customer service representative. Improper installation, misuse, misapplication or other failure to completely follow nVent's instructions and warnings may cause product malfunction, property damage, serious bodily injury and death and/or void your warranty.



# Featured Products



Featured Products

# Featured Products

Ideal for  
Pre-fab

## **nVENT CADDY ROD LOCK**

**SEE PAGE 8-6**

The Rod Lock family of products allows contractors to prefabricate complex assemblies at ground level or offsite, and then easily lift and lock them into place by pushing the threaded rod supports into the Rod Lock device. This ingenious technology works with threaded rod with burrs or imperfections, helping to eliminate clean-up time or the need to replace damaged threaded rod.

The most unique feature of the system is its breakthrough "push-to-install" design, which dramatically reduces the installation time of threaded rod support structures when compared to conventional fasteners. Simply speaking – Rod Lock is revolutionizing how contractors support conduit, cable tray, lights, ductwork and pipe by helping to make installations faster, easier and more secure.



# Featured Products



- Easy "push-to-install" design allows installers to simply push the threaded rod through the mounting hole, instantly holding it in position
- Prefabricated assemblies easily lift and lock into place, helping to save time and money
- Works with slightly damaged threads and minor burrs on threaded rod ends
- Design includes a release mechanism that works with pliers



## ROD LOCK SPRING STEEL ROD HANGER

SEE PAGE 17-20

- Supports rod from block or concrete walls



## ROD LOCK SPRING STEEL ROD HANGER WITH SHOT-FIRE BRACKET

SEE PAGE 17-21

- Suspends threaded rod without the need for additional hardware
- Complete with shot-fire bracket and pre-assembled drive pin
- Integrated pin installs easily using powder-actuated or single-shot gas-actuated tools



## ROD LOCK SPRING STEEL ROD HANGER TO FLANGE CLIP

SEE PAGE 17-4

- Threaded rod hanger can swivel to provide a vertical dropdown
- Requires only a hammer to install



## ROD LOCK SPRING STEEL ROD HANGER TO BEAM CLAMP

SEE PAGE 17-6

- Threaded rod hanger can swivel to provide a vertical dropdown

# Featured Products

Ideal for  
Pre-fab

## TELESCOPING STRUT REPLACEMENT

SEE PAGE 8-13, 27-2

The Telescoping Strut Replacement is an innovative alternative to using traditional strut channels for trapeze or other support structures that accommodates standard strut fittings. This telescoping solution eliminates the need to handle and cut long lengths of strut to size. The bracket telescopes to the desired length and is locked in place by snapping closed a spring retainer clip.

- Standard strut profile runs the entire length of the part, allowing most standard fittings to be placed anywhere between the rods
- Spring steel retainer strap can be manually locked into place, allowing a tool-free installation
- Ready to use out of the box and eliminates the need for cutting sections of strut
- Pre-cut design is easier to transport and store than standard lengths of strut



# Featured Products



## **NVENT CADDY SPEED LINK**

**SEE PAGE 20-1**

The Speed Link SLK system provides a versatile overhead support solution that is easy to adjust and installs quickly to almost any structure. It is available with a variety of specialty end fittings for the most common building structure types.

- Push/pull keyless release allows easy adjustments
- System supports both 1.5 mm and 2 mm cables
- Low-profile locking device minimizes visual impact
- Cable spread of 90 degrees allows positioning the device closer to the load

### **Structure Attachments for Steel & Concrete**



## **NVENT CADDY SPEED LINK SLS TRAPEZE KIT**

**SEE PAGE 20-18**

- Out of the box trapeze solution includes Telescoping Strut Replacement, wire rope with pre-assembled hook end-fitting, and two nVent CADDY Speed Link SLS locking devices
- Standard strut profile runs the entire length of the Telescoping Strut Replacement, allowing most standard fittings to be placed anywhere between the wire rope supports



# Featured Products

Featured Products



## **nVENT CADDY PYRAMID**

**SEE PAGE 19-1**

Pyramid rooftop supports are a surface mounted solution for supporting electrical and mechanical applications on a variety of roof surfaces. They offer superior load capacity and dramatically reduce installation time by replacing slow, heavy and labor-intensive methods for support of pipe, conduit, duct, cable tray and equipment. Unlike wood blocks, Pyramid supports are specifically designed for rooftop applications, incorporating unique materials and finishes that protect roof membranes and provide superior corrosion protection.





# Featured Products

## TELESCOPING PLUMBING PREFAB BRACKET

SEE PAGE 5-2

- Out-of-the-box in-wall solution for supporting supply and waste lines
- Includes an adjustable telescoping screw gun bracket that provides a mid-span support and accommodates non-standard stud spacing
- Multiple pilot holes in telescoping bracket
- Can be mounted to face or inside of stud
- Modular design can accommodate multiple pipe sizes of supply and waste lines
- Marked for easy identification of supply line offset
- Can mount pipe in all vertical or horizontal orientations
- Plastic bracket housing is non-corrosive and compatible with all varieties of pipe
- Additional clamps can be purchased separately for multiple supply line runs

Ideal for  
Pre-fab

## TELESCOPING SCREW GUN BOX BRACKET

SEE PAGE 5-11 - 5-12

- Improved design with stamped inch markings and pilot holes accelerates precise box conduit mounting between studs
- Can be mounted to face or inside of stud
- Adjustable for non-standard stud spacing



# Featured Products

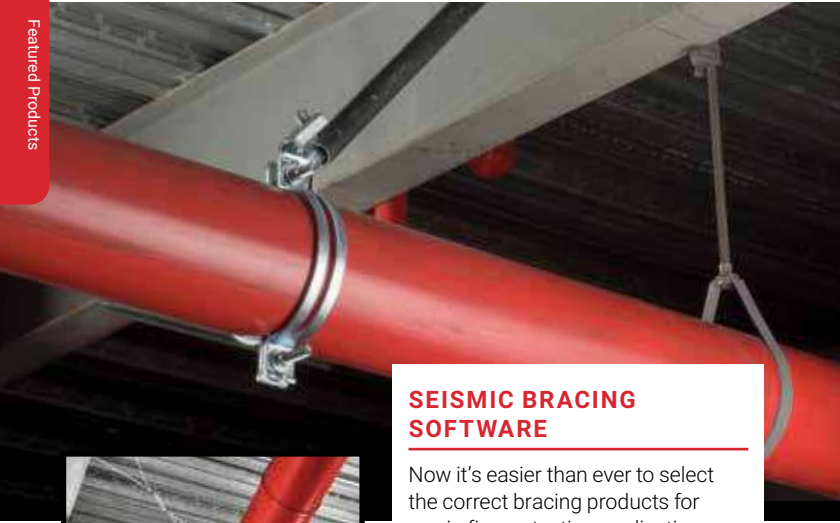

## SEISMIC BRACING SOFTWARE

Now it's easier than ever to select the correct bracing products for use in fire protection applications. nVent CADDY Bracing Systems Calculator is a web-based calculator which allows users to create and save designs for multiple projects while providing the necessary submittal forms. This time-saving calculator simplifies the selection of products and provides the necessary engineering calculations – providing a complete solution to support rigid bracing, cable bracing and branch line restraints.

- 3D models
- North American and European product lines
- No installation needed – access via a current web browser
- Offers dynamic design preview and uses visual design tools
- Generates a complete submittal for NFPA® or FM designs
- Create, manage, and re-use designs
- Supports NFPA® 13 including 2013 ed., IBC® and other building codes
- Ability to generate a material list (bill of material) with nVent CADDY products as well as other required materials (pipe, anchors, etc.)



# Featured Products

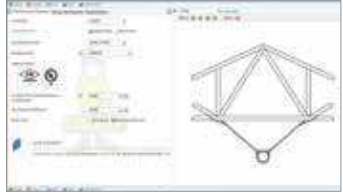

## BUILDING A COMPLETE SOLUTION WITH ENGINEERING SUPPORT SERVICES



### STARTING ON PAGE 21-1

The nVent CADDY team makes seismic simple by:

- Working with you to design a turn-key, fully engineered, complete bracing system that meets your needs
- Identifying the appropriate products from the broad offering
- Offering compatible fixing, fastening and support products
- Explaining installation techniques and tips to meet the evolving codes and standards requirements

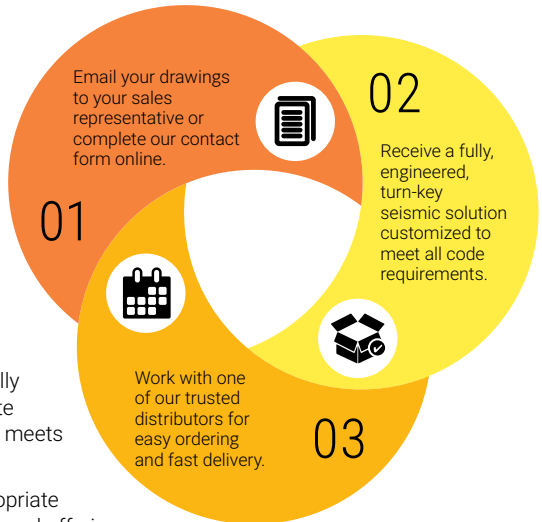

From design to construction to inspection, we keep our process transparent to ensure a full understanding of the final bracing installation, whether it requires cable or rigid bracing solutions.

# Featured Products



## STEEL FLANGE ADAPTER

SEE PAGE 21-2

- Meets requirements of the Buy American Act
- Installs on top or bottom flange of I-beams or bar joists
- Low profile easily fits between metal deck and steel structure
- Thumb spring retainer allows for ease of positioning
- Available pre-assembled to the Universal Structural Bracket, eliminating field assembly
- Snap-off bolt head helps enable easy installation and inspection of seismic sway braces
- Meets NFPA® 13 as pre-qualified for seismic applications
- FM® Specification Tested



Includes spring retainer clip



Available pre-assembled



## UNIVERSAL STRUCTURAL BRACKET

SEE PAGE 21-7

- Meets requirements of the Buy American Act
- Universal design allows one product to attach directly to concrete, wood, bar joist or I-beam adapters
- Integrated angle gauge easily displays brace member angle of installation
- Snap-off bolt head helps enable easy installation and inspection of seismic sway braces
- Works with 1" through 2" brace pipes to reduce inventory
- Low profile minimizes prying effect on concrete fasteners
- Meets NFPA® 13 as pre-qualified for seismic applications
- FM® Specification Tested

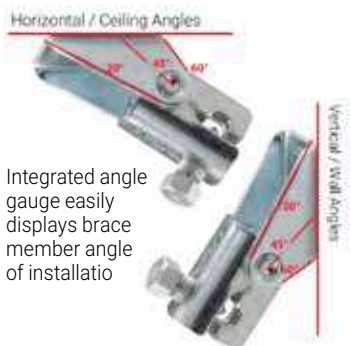

Integrated angle gauge easily displays brace member angle of installation

# Featured Products



## **UNIVERSAL SWAY BRACE**

SEE PAGE 21-9

- Meets requirements of the Buy American Act
- Use for both lateral and longitudinal sway brace applications
- Unique slotted holes provide for easy slip-on installation eliminating loose hardware
- Snap-off bolt head helps enable easy installation and inspection of seismic sway braces
- Works with 1" through 2" brace pipes to reduce inventory
- Meets NFPA®-13 requirements for seismic sway bracing
- FM® Specification Tested
- Meets CEN/TS 17551:2021 requirements for Seismic Sway Bracing

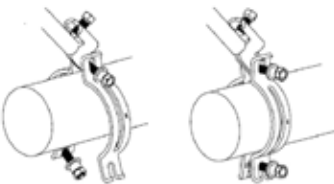

## **TRAPEZE SWAY BRACE, PIPE**

SEE PAGE 21-11

- Meets requirements of the Buy American Act
- Seismically braces trapeze hangers
- Retrofit ability allows for the brace to be installed after the trapeze assembly is installed
- Works with brace members of schedule 40 pipe, EMT conduit, and rigid conduit
- One wrench size fits all required hardware, eliminating the need to change tools
- Shear-off head helps ensure correct torque and simplifies inspection
- FM® Specification Tested

# Featured Products



## **NVENT CADDY CABLE BRACING SYSTEM**

### **SEE PAGE 22-2**

nVent CADDY Cable Bracing is an alternative to rigid bracing and branch line restraint for fire sprinkler systems and is very effective when bracing is required on long drops or when confined/crowded spaces make rigid systems difficult to install. The system includes pre-stretched steel cable, attachment fittings, crimping sleeves and related tools. The system can also be used to brace electrical, mechanical and plumbing systems.

- Color-coated cable conforms to NFPA® 13 requirements and makes it highly visible and easier to identify cable sizes
- UL® Listed
- OSHPD® Pre-Approved (OPA-0619)
- Made in the USA



## **NO PRY CLIP**

### **SEE PAGE 22-4**

A structural attachment that maximizes the load capacity on a post-installed concrete anchor by neutralizing the prying effect from the cable load. This increases the allowable design load per anchor and results in the need for fewer bracing locations.

- Eliminates prying effect on fasteners and anchors
- Meets CEN/TS 17551:2021 requirements for Seismic Sway Bracing



## **BATTERY-OPERATED SWAGING TOOL**

### **SEE PAGE 22-6**

Speeds and eases both bracing and branch line restraint installation. Provides consistent swaging and reduces the number of swages per sleeve compared to manual tools.

# Featured Products

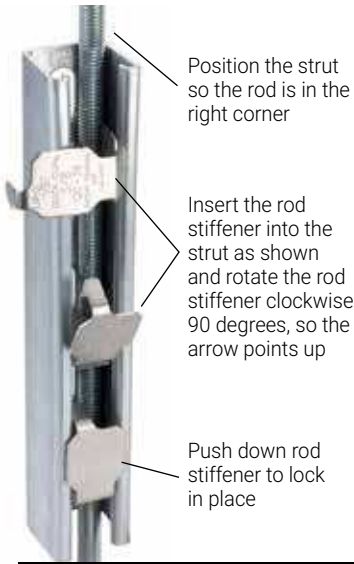

Position the strut so the rod is in the right corner

Insert the rod stiffener into the strut as shown and rotate the rod stiffener clockwise 90 degrees, so the arrow points up

Push down rod stiffener to lock in place

## **nVENT CADDY QUICK CLIP ROD STIFFENER**

SEE PAGE 24-3

A structural attachment that maximizes the load capacity on a post-installed concrete anchor by neutralizing the prying effect from the cable load. This increases the allowable design load per anchor and results in the need for fewer bracing locations.

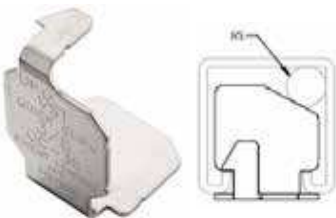

## **BRANCH LINE RESTRAINT SYSTEM**

SEE PAGE 23-2

- Complete restraint system includes structure and pipe attachments
- Works with 3/8" and 1/2" rod
- Quick and easy installation
- Pipe attachment includes snap-off heads help make installation and inspection quick and easy



## **LATERAL TELESCOPING BRACE ASSEMBLY**

SEE PAGE 6-5, 21-12

- Complete, out of the box assembly is compatible with both steel (IPS) and CPVC piping
- Telescoping brace member eliminates the need to cut pipe, minimizing waste and allowing one person to effectively complete the installation
- Easy "push-to-install" nVent CADDY Rod Lock feature allows the V-bolt to assemble quickly, and helps eliminate the risk of compressing CPVC pipe

# Featured Products



## **DROP-IN LOOP HANGER**

SEE PAGE 2-8

- Next generation loop hanger revolutionizes the installation of pipe
- Once on the guide arm, the weight of the pipe opens the self-closing latch and effortlessly guides the pipe into place
- Integrated rubber sleeve is designed to provide additional grip when adjusting hanger height and reduce hanger rotation around the barrel nut
- Eliminates the need to disassemble the hanger during installation



## **100T HEAVY DUTY TRAPEZE LOOP HANGER**

SEE PAGE 2-2

- Provides flexibility for installation in tight spaces and adaptability in system design
- NFPA®-compliant as a trapeze solution
- UL® Listed and FM® approved as both hanger and structural attachment
- Supports up to 8" diameter pipe
- Ideal for suspending stationary non-insulated lines from existing services
- Perfect for when you have limited or no access to traditional structural members
- Installs easily in orientations such as parallel to an I-beam or bar joist



## **511 EZ RISER FOR COPPER TUBE**

SEE PAGE 4-4

- Recommended for type K or L copper tubing risers



## **512 EZ RISER FOR CLOSE QUARTERS**

SEE PAGE 4-4

- Short ears allow for use in spaces where full-sized risers do not fit

# Featured Products



## **NVENT CADDY EZ RISER**

### **SEE PAGE 4-5**

- Support vertical pipe quickly and easily by combining three parts into one: a standard riser; a short ear riser; and a stand-off support
- Ready to install out of the box with patented hinge single-piece design
- Single tool installation made possible by carriage bolts eliminating the need for multiple tools when tightening
- Installs up to 60% faster than standard riser clamps (5 EZR's for every 2 traditional riser)
- MSS SP58 compliant and UL® Listed for fire protection applications
- Easily modified to short ear riser for use in tight spaces while retaining UL® listing
- Independent set of bolt holes allow for safer and easier installation in stand-off applications by separating clamping force from offset adjustment



## **NVENT CADDY SUPERFIX 454 STANDARD DUTY**

### **SEE PAGE 3-3**

- Recommended for the suspension of stationary non-insulated pipe lines
- Easy-to-close clamp for steel pipe and copper tube
- Unique hinged design eliminates the need to disassemble the clamp prior to installation
- Clamp can be closed with one hand, without ever turning a screw
- All-steel design of the closing mechanism retains strength even when exposed to heat
- Conforms with Manufacturers Standardization Society (MSS) SP-58 (Type 12)
- Comes with a welded 3/8" cap nut, allowing easy attachment to threaded rod
- Fire rating according to DIN to EN13501-1:E

# Featured Products



## **NVENT CADDY MACROFIX PLUS LF LOW-FRICTION**

### **SEE PAGE 3-2**

- Includes easy closing mechanism
- Age resistant lining designed specifically for plastic pipe applications
- Low-friction properties allow for expansion, contraction and easy sliding of pipe
- Fire rating according to DIN to EN13501-1:E
- Conforms with Manufacturers Standardization Society (MSS) SP-58 (Type 12)



## **MACROFIX PLUS NI EZ WITH EASY CLOSURE**

### **SEE PAGE 3-4**

- Contains easy closing mechanism
- Plastic washers help prevent crushing the CPVC or plastic pipe and assure a floating fit
- Flared edges and specially designed welding area help protect CPVC piping
- Ideal for installations where space is limited and require services to be ran close to the attachment surface
- Suitable for 3/4" - 2" steel sprinkler pipe
- Eliminates the need to seismically brace when drops are kept within 6" of the attachment surface
- Combo head bolt works with slotted, hex, or Phillips drivers
- Conforms with Manufacturers Standardization Society (MSS) SP-58 (Type 12)
- Meets the UL® 203 stringent upward thrust requirement
- UL® Listed as both a hanger and pipe restrainer



# Featured Products



## SOSR TWO HOLE STAND OFF STRAP

### SEE PAGE 6-4

- Includes flared edges to protect piping
- Rated for use with CPVC fire sprinkler pipe
- Positions pipe 1-1/2" off the mounting surface eliminating the need for wooden spacer blocks
- Can be mounted in both vertical and horizontal positions on concrete, steel and wood
- Meets the UL® 203 stringent upward thrust requirement
- UL® Listed as both a hanger and pipe restrainer
- Complies with static load requirements of NFPA® 13
- Includes mounting screws
- Can be used with 3TW backing nut on composite wood joist installations



## DOSR DOUBLE OFFSET SURGE RESTRAINT

### SEE PAGE 6-3

- Provides quick and easy snap-in installation of pipe
- Built-in nail tab allows for fast, temporary mounting to any surface
- Rated for use with CPVC fire sprinkler pipe
- Positions pipe 1-1/2" out and up from the mounting surface eliminating the need for wooden spacer blocks
- Meets the UL® 203 stringent upward thrust requirement
- UL® Listed as both a hanger and restraint in the double offset orientation
- Complies with static load requirements of NFPA® 13
- Includes mounting screws
- Can be used with 3TW backing nut on composite wood joist installations

# Featured Products



## **NVENT CADDY TRUSS-T HANGER**

**SEE PAGE 9-12**

Adapt – with just a twist. The nVent CADDY Truss-T Hanger is an innovative solution that increases jobsite efficiency by quickly adapting to recommendations of bar joist manufacturers. Easily hang with top or bottom chord configuration and replace the use of fender washers and hex nuts typically used today.

Quickly attach threaded rod to a top or bottom chord of engineered open web bar joists with the nVent CADDY Truss-T Hanger. The attachment easily slides through the middle of the bar joist and quickly locks into place when put under load, limiting overhead work.

- Installation of the complete, self-contained system can be accomplished with one hand and requires no additional special tools
- The unique design of the nVent CADDY Truss-T hanger does not need to be tightened like a traditional beam clamp, providing greater adjustability and speed during system alignment
- Meets the UL® 203 requirement
- Concentrically loading the bar joist chord eliminates torsion and/or distortion, adhering to the strict rules established by the Steel Joist Institute (SJI)



## **NVENT CADDY ROD LOCK BAR JOIST HANGER**

**SEE PAGE 8-4**

- Easily installs from underneath the bar joist
- Easily installs on lower or upper truss chord of the bar joist
- Plastic protection cap prevents dirt or structural coatings from obstructing the “push-to-install” mechanism
- Prefabricated assemblies easily lift and lock into place, helping to save time and money
- Easy “push-to-install” design allows installers to simply push the threaded rod through the mounting hole, instantly holding it in position
- Works with slightly damaged threads and minor burrs on the threaded rod

# Featured Products



## **nVENT CADDY TELESCOPING PIPE STAND**

**SEE PAGE 14-9**

Reduce fabrication and install time with the nVent CADDY Telescoping Pipe Stand. The V-Head design supports pipe diameter of 1" through 24" and can easily adjust up to 16" in height, allowing you to quickly adapt to support needs in the field.

- Ideal for the support of pipe in back flow preventers and pump rooms
- Push to install V-bolt fastener accommodates multiple pipe sizes (1" to 10")
- CTS04 supports 1" to 8" Pipe if the v-bolt is not used
- CTS10 supports 5" to 24" Pipe if the v-bolt is not used
- Electro-galvanized finish is standard and provides corrosion protection
- Two methods of height adjustment for both large and fine changes



## **SBC STAMPED BEAM CLAMP, TOP MOUNT**

**SEE PAGE 9-4**

- Allows structural attachment to metal beams, bar joist, channel, or angle iron in top mount position only unless used on a parallel flange
- Superior pre galvanized finish available at cost comparable to plain finish cast beam clamp
- Lightweight, one-piece stamped body provides superior strength and eliminates deficiencies associated with castings



## **RS RETROFIT RETAINER STRAP**

**SEE PAGE 9-9**

- Can be installed without disassembly of the hanging system and/or removing the clamp
- Large teardrop-shaped opening is compatible with multiple threaded rod diameters, reducing inventory by 50%
- Coined edge on teardrop-shaped opening locks into rod, eliminating shifting during install

# Featured Products



## NVENT CADDY SWIFT CLIP STRUT CLAMP FOR TUBE/PIPE

---

### SEE PAGE 7-4

- Secures pipe while allowing it to expand, preventing cracked and fractured joints
- Snap-in and twist installation requires no tools
- Fits directly into vertical and horizontal strut channels
- Use for installation of refrigeration, A/C tubing and PEX piping in horizontal and vertical channels
- Compliant with UL® 2043 and suitable for use in air handling spaces



## NVENT CADDY SWIFT CLIP STRUT CLAMP FOR INSULATED TUBE/PIPE

---

- Secures pipe and insulation without a break, providing an uninterrupted vapor barrier seal which eliminates sweating on metal fittings



## NVENT CADDY SWIFT CLIP THREADED ROD ATTACHMENT

---

### SEE PAGE 5-6

- Snap-on and twist installation requires no tools
- Easily adjusts by rotating up or down on the threaded rod
- For support and positioning of refrigeration, A/C tubing, PEX piping, conduit and cabling
- Secures pipe and insulation without any breaks

# Applications



Applications

# Applications

## PIPE HANGERS



Page 9-4, 1-2



Page 9-4, 2-2



Page 1-5



Page 3-2



Page 3-3



Page 2-8



Page 10-4



Page 5-6



Page 6-3

# Applications

## TRAPEZE APPLICATIONS



Page 17-3, 25-2, 7-6



Page 8-12, 9-2, 27-7, 7-3



Page 8-13, 7-8



Page 20-18, 7-3



Page 17-4, 7-3, 27-8



Page 8-4, 7-8

# Applications

## STUDWALL



Page 5-2



Page 5-11, 5-4, 15-3



Page 5-4, 5-11



Page 15-4



Page 6-4



Page 5-4



Page 5-12, 5-6



# Applications

## STRUT FASTENERS



Page 27-8, 7-5



Page 7-4



Page 7-8



Page 17-3, 25-2, 7-6



Page 7-2

## RISER CLAMPS



Page 94



Page 96

# Applications

## DUCT - RECTANGLE



Page 20-6, 20-24



Page 20-3, 20-26, 27-8

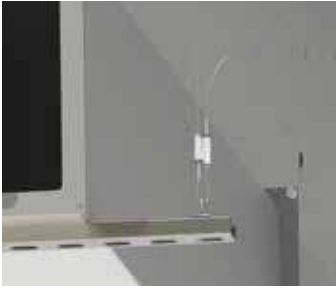

Page 20-10, 20-26, 27-8



Page 20-4, 20-24



Page 8-12, 9-2, 27-7, 7-3



Page 8-11

# Applications

## DUCT - RECTANGLE

---



Page 20-25



Page 8-2, 8-15, 27-8

Applications

## DUCT - ROUND

---



Page 18-2



Page 18-2



Page 18-3



Page 20-7

# Applications

## THREADED ROD HANGERS



Page 8-2



Page 9-4



Page 9-3



Page 9-3



Page 17-2



Page 17-4



Page 17-17



Page 9-6



Page 10-2, 25-2

# Applications

## THREADED ROD HANGERS



Page 9-14, 25-2



Page 17-7



Page 17-9



Page 8-5



Page 26-7



Page 11-3



Page 17-4, 7-3



Page 27-12, 25-2

# Applications

## WIRE ROPE



Page 20-7, 9-17



Page 20-7, 9-16



Page 20-7, 10-2



Page 20-6



Page 20-9, 9-5



Page 20-4



Page 20-3



Page 20-5



Page 20-7, 20-26

# Applications

## CONDUIT



Page 9-21



Page 9-21



Page 10-4



Page 10-4



Page 7-9

# Applications

## ROOFTOP SUPPORTS



Page 19-6



Page 19-6



Page 19-2



Page 19-4



Page 19-5, 19-2, 19-3



Page 19-23



Page 19-9



# Applications

## RIGID BRACING



Page 21-3, 21-10, 21-9

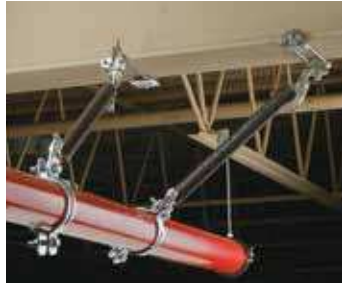

Page 21-4, 21-7, 21-9



Page 21-5, 21-7, 21-10, 1-2



Page 21-3, 21-9, 21-10

## CABLE BRACING



Page 22-5, 1-2



Page 22-3, 23-2

# Applications

## BRANCH LINE



Page 23-3



Page 23-2



Page 23-3, 9-3



Page 23-2, 23-3, 2-5

## ROD STIFFENER



Page 24-3



Page 24-3



Page 24-3

# Applications

## STRUT



Page 27-31, 25-2



Page 27-11



Page 27-27



Page 20-18, 7-3



Page 9-12, 27-7, 7-8



Page 27-24, 327



Page 27-25, 327

# Applications

## STRUT

Applications



Page 27-26



Page 27-26, 7-2



Page 27-25



Page 27-31

# Clevis Hangers



1-2  
401 Clevis Hanger



1-3  
402 Clevis Hanger for  
Copper Tube, Light  
Duty



1-4  
403 Clevis Hanger  
with Insulation Shield



1-5  
406 Clevis Hanger,  
Stainless Steel



1-6  
410 Clevis Hanger,  
Light Duty

Picture Reference

# Loop Hangers



2-2  
100 Heavy Duty Loop  
Hanger



2-2  
100T Heavy Duty  
Trapeze Loop Hanger



2-3  
101 Loop Hanger for  
Copper Tube



2-3  
104 Loop Hanger for  
Plastic Pipe

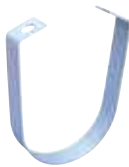

2-4  
105 Stainless Steel  
Loop Hanger



2-4  
Insert Nut for Loop  
Hanger

# Loop Hangers



2-5

115 Standard Duty Loop Hanger



2-6

115FL Standard Duty Loop Hanger, Felt Lined



2-6

115 Surge Restraint



2-7

116 Loop Hanger, Epoxy Coated



2-8

Drop-In Loop Hanger



2-8

DH Surge Restraint

Picture Reference

# Split Ring Hangers



3-2

nVent CADDY Macrofix Plus LF Low-Friction



3-3

nVent CADDY Superfix 454 Standard Duty



3-4

nVent CADDY Macrofix Plus NI EZ with Easy Closure



3-5

455 Malleable Split Ring Hanger



3-6

456 Malleable Split Ring Hanger for Copper Tube



3-6

BH Bell Hanger Pipe Clamp

# Riser Clamps



4-2

510 nVent CADDY EZ Riser



4-4

511 nVent CADDY EZ Riser for Copper Tube



4-4

512 nVent CADDY EZ Riser for Close Quarters



4-5

nVent CADDY EZ Riser



4-6

520 nVent CADDY EZ Riser, Epoxy Coated

Picture Reference

# Pipe Fixings

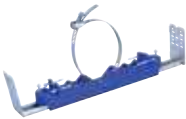

5-2

Telescoping Plumbing Prefab Bracket

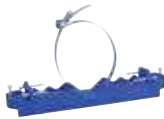

5-3

Plumbing Prefab Bracket



5-3

Plumbing Prefab Bracket Clamp



5-4

nVent CADDY Superklip



5-5

nVent CADDY Superklip BP1 Base Plate for Two Clips



5-5

nVent CADDY Superklip CA Concrete Attachment

# Pipe Fixings



5-6

nVent CADDY Swift Clip Threaded Rod Attachment



5-6

TPC Tube and Pipe Clamp



5-7

Bolt Close Pipe Clamp for Copper Tube

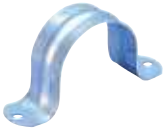

5-8

Two Hole Pipe Strap



5-8

One Hole Strap for Pipe and Conduit



5-9

800 Extended Pipe Stay



5-9

801 Standard Pipe Stay



5-10

150M Standard U-Bolt



5-11

Snap to Stud Telescoping Screw Gun Box Bracket



5-11

Screw Gun Bracket

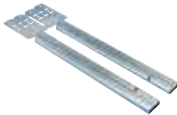

5-12

Telescoping Screw Gun Box Bracket

Picture Reference



# Pipe Fixings – CPVC



6-2

107 Wraparound Strap for CPVC Pipe



6-2

108 Two Hole Strap for CPVC Pipe

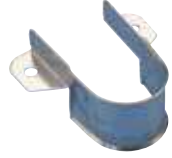

6-3

109 Side Mount Strap for CPVC Pipe



6-3

DOSR Double Offset Surge Restraint for CPVC Pipe



6-4

SOSR Stand Off Two Hole Strap for CPVC Pipe



6-4

3TW Fastener



6-5

Lateral Telescoping Brace Assembly

Picture Reference

# Strut Clamps



7-2

RIGD Single Piece Strut Clamp for Pipe/Rigid Conduit



7-3

COPC Single Piece Strut Clamp for Copper Tube



7-3

USC Universal Strut Clamp for Copper Tube

# Strut Clamps



7-4

nVent CADDY Swift Clip Strut Clamp for Tube/Pipe



7-5

nVent CADDY Swift Clip Strut Clamp for Insulated Tube/Pipe



7-6

USC Universal Strut Clamp for Pipe/Conduit



7-8

nVent CADDY Cushion Clamp Insulated Strut Clamp for Pipe/Tube



7-9

SCH2 Single Piece Strut Clamp for CABLE/Conduit



7-10

SK Single Piece Strut Clamp for Conduit

Picture Reference

# nVent CADDY Rod Lock



8-2

nVent CADDY Rod Lock Beam Clamp



8-3

nVent CADDY Rod Lock Beam Clamp, Thick Flange



8-4

nVent CADDY Rod Lock Bar Joist Hanger



8-5

nVent CADDY Rod Lock Anchor Screw



8-5

nVent CADDY Rod Lock Anchor Screw Drive Socket



8-6

nVent CADDY Rod Lock Metal Decking Preset Anchor

# nVent CADDY Rod Lock



8-7

nVent CADDY Rod Lock Metal Decking Preset Anchor Insert



8-8

nVent CADDY Rod Lock Plywood Form Preset Anchor



8-9

nVent CADDY Rod Lock L-Bracket



8-10

nVent CADDY Rod Lock Coupler



8-10

nVent CADDY Rod Lock Coupler with Rod



8-11

nVent CADDY Rod Lock Bottom-Mount Duct Bracket



8-12

nVent CADDY Rod Lock Strut



8-13

nVent CADDY Rod Lock Telescoping Strut Replacement



8-14

nVent CADDY Rod Lock Channel Nut



8-14

nVent CADDY Rod Lock Height-Adjustable Strut Nut

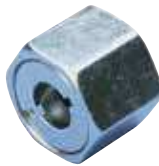

8-15

nVent CADDY Rod Lock Nut



8-15

SN Series Nut



8-16

SNSW Flanged Nut

Picture Reference

# Structural Attachments – Beam/Purlin



9-2

300 Universal Beam Clamp



9-3

310 Universal Beam Clamp, Thick Flange



9-3

BC26 Universal Beam Clamp with Tapped Hole



9-4

305 Stainless Steel Beam Clamp, Top Mount



9-4

SBC Stamped Beam Clamp, Top Mount



9-5

BC Beam Clamp



9-5

BC200/BC400 Beam Clamp



9-6

BC10 Multi-Function Beam Clamp



9-6

BC10 Beam Clamp with BC15 Swivel



9-7

BC11/BC12 Multi-Function Clamp with J-Bolt



9-7

BC13 Welded Beam Clamp, Standard Duty



9-8

BC14 Welded Beam Clamp, Heavy Duty



9-8

C-Clamp



9-9

C-Clamp for Strut and Rod



9-9

RS Retrofit Retainer Strap

# Structural Attachments – Beam/Purlin



9-10

35RS Two Hole Retainer Strap



9-10

BC09 Retainer Strap for BC13/14 Series



9-11

360 Adjustable Center-Load Beam Clamp Kit



9-11

Hammer-On Flange Clip, Side Mount



9-12

nVent CADDY Truss-T Bar Joist Hanger, Bottom Chord



9-13

nVent CADDY Truss-T Bar Joist Hanger, Top Chord



9-14

PH Multi-Purpose Purlin Clamp



9-14

PHSW Multi-Purpose Purlin Clamp with Swivel



9-15

315 Malleable Iron Purlin Clamp



9-15

122 Series Z Purlin Clip



9-16

123 Series Z Purlin Clip



9-16

AF Series Z Purlin Clip



9-17

VF Series C Purlin Clip



9-17

VAFT Installation Tool for Purlin Clips

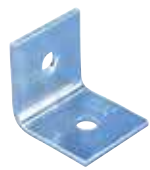

9-18

325 Steel Side Beam Attachment

Picture Reference

## Structural Attachments – Beam/Purlin



9-18

327 Malleable Iron Side Beam Attachment



9-19

328 Threaded Steel Side Beam Attachment



9-19

329 Side Beam Attachment



9-20

38 Offset Steel Eye Socket Rod Hanger



9-21

BC200-CD CONDUIT TO BEAM CLAMP



9-21

RA Right Angle Pipe and Conduit Clamp

Picture Reference

## Structural Attachments – Deck



10-2

TDH Trapezoidal Deck Hanger



10-2

TDHT Trapezoidal Deck Hanger with Nut



10-3

TDHP Trapezoidal Deck Hole Punch and Replacement Die



10-3

Cellular Floor Deck Hanger for Threaded Rod



10-4

CD-CPNAM Conduit/Pipe to Deck Angle Bracket



10-4

CD-TDH Conduit/Pipe to Deck Hanger

# Structural Attachments – Wall/Ceiling



11-2

Angle Bracket with Shot-Fire Bracket



11-3

Angle Bracket with Nail Gun Insert

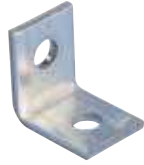

11-3

Angle Bracket



11-4

Pin Driven Angle Bracket



11-4

Offset Bracket



11-5

365 Steel Wall or Ceiling Plate



11-5

365M Malleable Iron Wall or Ceiling Plate



11-6

352 Standard Duty Welded Wall Bracket

Picture Reference

# Structural Attachments – Concrete Inserts



12-2

355 Concrete Insert

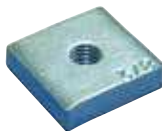

12-2

355N Insert Nut for 355 Concrete Insert



12-3

370A Single Concrete Insert Plate and Rod

# Shields and Saddles



13-2

119 Strut Mounted Insulation Shield



13-4

125 Weldable Insulation Shield



13-6

630 Pipe Saddle for 1" Insulation



13-8

631 Pipe Saddle for 1 1/2" Insulation



13-10

632 Pipe Saddle for 2" Insulation



13-12

633 Pipe Saddle for 2 1/2" Insulation



13-14

634 Pipe Saddle for 3" Insulation



13-16

635 Pipe Saddle for 4" Insulation

Picture Reference

# Rollers and Supports



14-2

605 Two-Rod Roller Hanger



14-3

610 One-Rod Roller Hanger



14-4

ROL12 Strut Mounted Roller



# Rollers and Supports



14-6

ROL13 Strut Mounted Roller



14-7

ROL14 Strut Mounted Roller

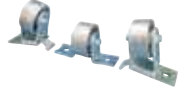

14-8

ROL15 Strut Mounted Roller



14-9

Telescoping Pipe Stand

Picture Reference

# In-Wall Fasteners



15-2

Snap-On Nail Plate



15-2

SMS8 Self-Drilling and Tapping Screw



15-3

Easy Snap Grommet



15-3

Easy Snap Grommet with Anti-Rattle Protection

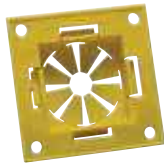

15-4

Easy Snap Grommet for Factory Punched Holes



15-4

MSP20 Metal Stud Punch for Easy Snap Grommet

# Ceiling/Acoustical



16-2

Lay-In and Troffer Support Clip, Straight Lip



16-2

Lay-In and Troffer Support Clip, Straight/Upturned Lip

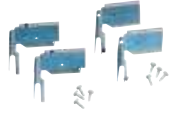

16-3

Seismic Lighting Fixture Clamp



16-4

Telescoping Ceiling Bracket

Picture Reference

# Threaded Rod Hangers



17-2

Hammer-On Flange Clip, Bottom Mount



17-2

Hammer-On Flange Clip, Bottom Mount with Stud



17-3

Hammer-On Flange Clip, Bottom Mount with Retainer



17-3

H-Ti/T Rod to Flange Clip



17-4

H-Ti/TR Rod to Flange Clip with Retainer



17-4

nVent CADDY Rod Lock Spring Steel Rod Hanger to Flange Clip

# Threaded Rod Hangers



17-5

H-6A Rod to Flange Clip



17-5

H-708 Rod/Wire to Flange Clip



17-6

nVent CADDY Rod Lock Spring Steel Rod Hanger to Beam Clamp



17-6

122-6A Rod to Z Purlin Clip



17-7

122-708 Rod/Wire to Z Purlin Clip



17-7

122-Ti/T Rod to Z Purlin Clip



17-8

AF-6A Rod to Z-Purlin Clip



17-8

AF-708 Rod/Wire to Z Purlin Clip



17-9

AF-Ti/T Rod to Z Purlin Clip



17-9

VF-6A Rod to C-Purlin Clip



17-10

VF-708 Rod/Wire to C Purlin Clip



17-10

VF-Ti/T Rod to C-Purlin Clip



17-11

Push Install Rod Hanger



17-11

Push Install Rod Hanger with Shot-Fire Bracket



17-2

Push Install Rod Hanger with Angle Bracket

# Threaded Rod Hangers



17-12

Push Install Rod Hanger with Offset Bracket



17-13

Push Install Rod Hanger with Pin Driven Angle Bracket



17-13

Push Install Rod/Wire Hanger



17-14

Push Install Rod/Wire Hanger with Shot-Fire Bracket



17-15

Push Install Rod/Wire Hanger with Nail Gun Bracket



17-15

Push Install Rod/Wire Hanger with Angle Bracket



17-16

Push Install Rod/Wire Hanger with Offset Bracket



17-16

Push Install Rod/Wire Hanger with Pin Driven Angle Bracket



17-17

Thread Install Rod Hanger



17-17

Thread Install Rod Hanger with Angle Bracket



17-18

Thread Install Rod Hanger with Shot-Fire Bracket



17-18

Thread Install Rod Hanger with Nail Gun Bracket



17-19

Thread Install Rod Hanger with Offset Bracket



17-19

Thread Install Rod Hanger with Pin Driven Angle Bracket



17-20

nVent CADDY Rod Lock Spring Steel Rod Hanger

# Threaded Rod Hangers



17-20

nVent CADDY Rod Lock Spring Steel Rod Hanger with Angle Bracket



17-21

nVent CADDY Rod Lock Spring Steel Rod Hanger with Shot-Fire Bracket



17-22

nVent CADDY Rod Lock Spring Steel Rod Hanger with Nail Gun Bracket



17-23

nVent CADDY Rod Lock Spring Steel Rod Hanger with Offset Bracket



17-24

nVent CADDY Rod Lock Spring Steel Rod Hanger with Pin Driven Angle Bracket

Picture Reference

# Strap Hangers



18-2

H-MSR 90° Strap Hanger with Flange Clip



18-2

H-MSS Inline Strap Hanger with Flange Clip



18-3

Strap Hanger with Shot-Fire Bracket

# nVent CADDY Pyramid



19-2

nVent CADDY Pyramid ST Fixed Strut Support



19-3

nVent CADDY Pyramid ST Adjustable Strut Support



19-4

nVent CADDY Pyramid ST Bridge Assembly



19-5

nVent CADDY Pyramid RL Fixed Roller Support



19-6

nVent CADDY Pyramid RL Adjustable Roller Support



19-6

Retainer Strap



19-7

nVent CADDY Pyramid H-Frame Post Base



19-8

nVent CADDY Pyramid H-Frame Kit



19-8

nVent CADDY Pyramid H-Frame Hardware Kit

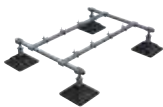

19-9

nVent CADDY Pyramid Equipment Support Kit, 4 Post Base



19-10

nVent CADDY Pyramid Equipment Support Kit, 6 Post Base



19-11

nVent CADDY Pyramid Equipment Support Frame Extension Kit



19-11

nVent CADDY Pyramid Equipment Support Post



19-12

nVent CADDY Pyramid Equipment Support Square Tube



19-12

nVent CADDY Pyramid Equipment Support Crossbar

# nVent CADDY Pyramid



19-12

nVent CADDY Pyramid Equipment Support Height Extension

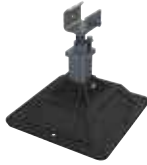

19-13

nVent CADDY Pyramid Equipment Support Post Base



19-13

nVent CADDY Pyramid Equipment Support Clamp



19-14

nVent CADDY Pyramid Crossover Ladder, 50°



19-15

nVent CADDY Pyramid Crossover Ladder, 90°



19-16

nVent CADDY Pyramid Crossover Support Tower



19-17

nVent CADDY Pyramid Crossover Bridge



19-17

nVent CADDY Pyramid Crossover Bridge Turn Kit



19-18

nVent CADDY Pyramid Crossover Guardrail Kit

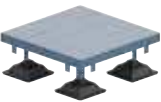

19-18

nVent CADDY Pyramid Crossover Platform



19-19

nVent CADDY Pyramid 50 Foam-Based Support



19-20

nVent CADDY Pyramid Rooftop Anchor



19-21

nVent CADDY Pyramid Rooftop Anchor Cable Bracing



19-21

Deck Screw



19-22

Multi-Size Manual Swaging Tool & Wire Rope Cutter

Picture Reference

## nVent CADDY Pyramid



19-23

nVent CADDY Pyramid EZ Rubber-Based Adjustable Support



19-23

nVent CADDY Pyramid EZ Rubber-Based Support



19-24

nVent CADDY Pyramid Tool-Free Pipe Support Kit



19-25

nVent CADDY Pyramid Tool-Free Pipe Clamp



19-25

nVent CADDY Pyramid Universal Support



19-26

nVent CADDY Pyramid 25 Pipe and Conduit Support, Plastic

Picture Reference

## nVent CADDY Speed Link



20-2

nVent CADDY Speed Link SLK with Angle Bracket



20-3

nVent CADDY Speed Link SLK with Shot-Fire Bracket



20-4

nVent CADDY Speed Link SLK with Nail Gun Bracket



20-5

nVent CADDY Speed Link SLK with Decking Hook



20-6

nVent CADDY Speed Link SLK with Hammer-On Flange Clip



20-7

nVent CADDY Speed Link SLK with Hook



# nVent CADDY Speed Link



20-8

nVent CADDY Speed Link SLK with Loop



20-9

nVent CADDY Speed Link SLK with Threaded Stud End



20-10

nVent CADDY Speed Link SLK with Wedge Anchor



20-11

nVent CADDY Speed Link SLK with Toggle



20-12

nVent CADDY Speed Link SLK with Y-Hook



20-13

nVent CADDY Speed Link SLK with Y-Toggle



20-14

nVent CADDY Speed Link SLS with Decking Hook



20-15

nVent CADDY Speed Link SLS with Hook



20-16

nVent CADDY Speed Link SLS with Threaded Stud End



20-17

nVent CADDY Speed Link SLS with Wedge Anchor



20-18

nVent CADDY Speed Link SLS Trapeze Kit



20-19

nVent CADDY Speed Link LD with Hook



20-19

nVent CADDY Speed Link Y-Hook with Eyelet Extension



20-20

nVent CADDY Speed Link Y-Toggle with Eyelet Extension



20-20

nVent CADDY Speed Link Quad-Toggle with Eyelet Extension

# nVent CADDY Speed Link



20-21

nVent CADDY Speed Link SLK Spool Kit



20-22

nVent CADDY Speed Link SLK Locking Device



20-22

nVent CADDY Speed Link LD Locking Device



20-23

nVent CADDY Speed Link SLS Locking Device



20-23

Wire Spool



20-24

Wire Rope Cutter

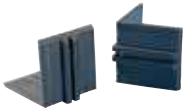

20-24

Air Duct Corner Protector



20-24

Air Duct Support Attachment



20-25

Air Duct Bracket Kit



20-25

Angle Bracket With Oblong Hole



20-26

Concrete Fixing Eyebolt Screw



20-26

Wood Fixing Eye Screw



20-26

Eye Screw

# Rigid Bracing System



21-2

Steel Flange Adapter



21-3

Steel Flange Adapter Assembly



21-4

Adjustable I-Beam Adapter



21-5

Multi Attachment



21-6

Strut Seismic Hinge Bracket Assembly



21-7

Universal Structural Bracket



21-8

Universal Structural Bracket, Strut Brace



21-9

Universal Sway Brace



21-10

Quick Grip Jr. Lateral Sway Brace



21-10

Quick Grip Lateral Sway Brace



21-11

Trapeze Sway Brace, Strut



21-11

Trapeze Sway Brace, Pipe



21-12

Lateral Telescoping Brace Assembly



21-12

Self Drilling Screw



21-13

Cone Point Shear Bolt

Picture Reference

# Rigid Bracing System



21-13  
Rivet Head Shear Bolt



21-13  
Shear Nut

# Cable Bracing System

Picture Reference



22-2  
Cable Spool



22-2  
Wire Rope Cutter

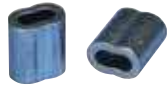

22-3  
Oval Sleeve



22-3  
Universal Restraint  
Clip



22-4  
Universal Restraint  
Clip, Slotted



22-4  
No Pry Clip



22-5  
URC Attachment Kit



22-6  
Swaging Tools



22-6  
Battery-Operated  
Swaging Tool

# Branch Line Restraint System



23-2

Branch Line Restraint Pipe Attachment



23-2

Branch Line Restraint Structure Attachment to Steel



23-3

Branch Line Restraint Structure Attachment to Wood/Concrete



23-3

Branch Line Restraint Structure Attachment to Threaded Hole

Picture Reference

# Bracing Accessories



24-2

Strut Seismic Hinge



24-2

Clevis Bolt Spacer



24-3

Pipe Rod Stiffener



24-3

Strut Rod Stiffener



24-3

nVent CADDY Quick Clip Rod Stiffener



24-4

Seismic Lighting Fixture Clamp

# Hardware

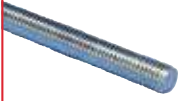

25-2

Threaded Rod

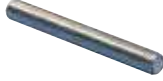

25-2

Threaded Stud



25-3

EM-HEX Rod Coupler



25-3

25R Hex Rod Reducer



25-4

26 Beam Clamp Extension Piece



25-4

35 Heavy Duty Eye Nut



25-5

47 Eye Nut



25-5

SWFF Swivel Female-Female



25-5

SWMF Swivel Male-Female



25-6

Fixture Support from Plain Rod/Wire



25-6

Threaded Rod Hanger from Bar Joist



25-7

41 Coach Screw

# Hardware



25-7

42 Hex Head Lag Screw



25-8

43 Wood Drive Screw



25-8

A33 Screw



25-8

Combi Dome Screw



25-9

Flat Head Carriage Bolt



25-9

Hex Head Bolt

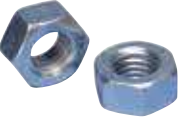

25-10

Hex Nut

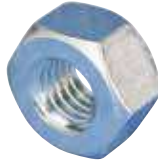

25-10

Heavy Duty Hex Nut



25-11

Flat Washer



25-11

Large Washer



25-12

740 Pipe Sleeve Positioner

# Anchors



26-2

Wedge Expansion Anchor Bolt



26-2

Concrete Anchor Screw



26-3

Drop-In Anchor



26-3

Flanged Drop-in Anchor



26-4

Spike Anchor



26-4

HangerMate® Vertical Mount Screw for Steel



26-5

HangerMate® Vertical Mount Screw for Steel with Lock Nut



26-5

HangerMate® Horizontal Mount Screw for Steel



26-5

HangerMate® Horizontal Mount Screw for Steel with Lock Nut



26-6

HangerMate® Vertical Mount Screw for Wood



26-6

HangerMate® Horizontal Mount Screw for Wood



26-7

HangerMate® Vertical Mount Screw for Concrete



26-7

HangerMate® Hex Drive Socket



26-7

HangerMate® SDS Drill Bit for Hammer Drills



26-8

145 Spring Toggle



# nVent CADDY Eristrut



27-2  
Telescoping Strut Replacement



27-3  
Telescoping Strut Replacement, No Nut



27-4  
Telescoping Strut Replacement, Retrofit



27-5  
nVent CADDY Rod Lock Telescoping Strut Replacement



27-6  
nVent CADDY Speed Link SLS Trapeze Kit



27-7  
Strut Channel Type A, Slotted

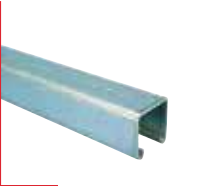

27-7  
Strut Channel Type A, Solid



27-8  
Strut Channel Type AA, Slotted



27-8  
Strut Channel Type C, Slotted



27-9  
Strut Channel Type C, Solid



27-9  
Strut Channel Type D, Slotted



27-10  
Strut Channel Type D, Solid



27-10  
Strut Channel Type E, Slotted

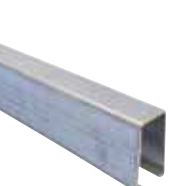

27-10  
Strut Channel Type E, Solid

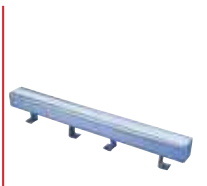

27-11  
Strut Channel Concrete Insert

Picture Reference

# nVent CADDY Eri strut



27-11

Strut to Strut Connector



27-11

ADK Strut End Cap

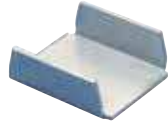

27-12

ENDC Strut End Cap



27-12

Strut Channel Cover



27-12

nVent CADDY Slick Nut



27-13

Strut Nut without Spring



27-14

Strut Nut with Spring, Channel Type A



27-14

Strut Nut with Spring, Channel Type C

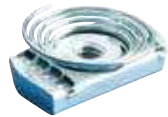

27-15

Strut Nut with Top Spring



27-15

Clip-On Strut Nut



27-16

nVent CADDY Rod Lock Spring Steel Strut Nut

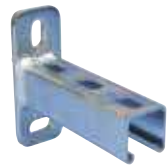

27-17

Strut Cantilever Arm Type A, Slotted

# nVent CADDY Eristrut

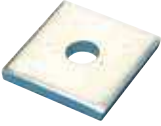

27-17

Square Channel Washer



27-18

Two Hole Flat Bracket



27-18

Three Hole Flat Bracket



27-18

Three Hole Flat Corner Bracket



27-19

Four Hole Flat Bracket

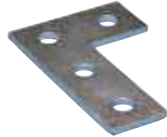

27-19

Four Hole Flat Corner Bracket



27-19

Four Hole Flat Tee Plate



27-20

Five Hole Flat Cross Bracket

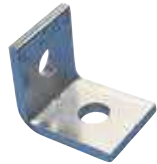

27-20

1-1 Hole Angle Bracket

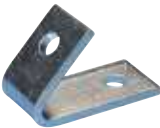

27-20

1-1 Hole Closed Corner Angle Bracket



27-21

1-1 Hole Open Corner Angle Bracket

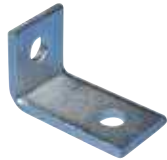

27-21

1-1 Hole Unequal Long Angle Bracket

Picture Reference

# nVent CADDY Eri strut

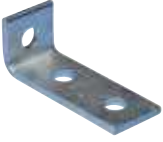

27-21

1-2 Hole Corner Angle Bracket

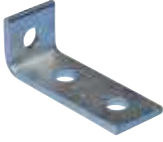

27-22

1-2 Hole Corner Short Angle Bracket



27-22

2-2 Hole Corner Angle Bracket



27-22

1-1 Hole 45° Angle Brace

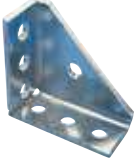

27-23

3-3-1 Hole Corner Gusset

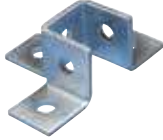

27-23

Six Hole Corner Connector, 3-Way



27-23

Eight Hole Double Corner Connector, 3-Way



27-24

Nine Hole Corner Connector, 3-Way



27-24

Strut Beam Clamp with U-Bolt

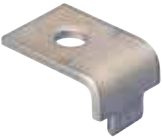

27-25

Strut Beam Clip

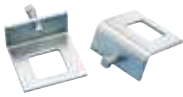

27-25

Strut Beam Clamp with Bolt, Window Shape



27-26

Internal Strut Beam Clamp with Bolt

Picture Reference

# nVent CADDY Eristrut



27-26

Strut and Rod Beam Clamp



27-27

BC23 Internal Strut Beam Clamp



27-27

INC8 Internal Strut Beam Clamp



27-28

Post Base for Strut Type A



27-28

45° Post Base for Strut Type A

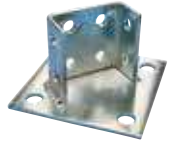

27-29

45° Post Base for Strut Type AA

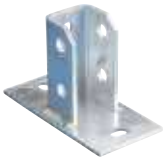

27-29

Rectangular Post Base Plate



27-29

Four Hole External Coupler



27-30

2-2 Hole Adjustable Strut Swivel Bracket



27-30

Strut Trapeze Attachment Plate



27-31

Strut Trapeze Attachment Kit



27-31

Strut Trolley, One Axle

Picture Reference

# nVent CADDY Eristrut



27-30

Strut Trolley, Two Axles



27-32

ESC Strut Attachment Clip



27-32

Threaded Rod to Strut Clip



27-32

Sound Insulation Rubber for Strut Pipe Clamps

Picture Reference

# Clevis Hangers



Clevis Hangers

# CLEVIS HANGERS

## 401 CLEVIS HANGER

- Recommended for the suspension of stationary non-insulated pipe lines
- Flared edges help prevent sharp surfaces from coming into contact with the pipe (1/2" to 2" pipe sizes)
- Clevis bottom pivots to allow pipe to be fed from either direction
- Conforms with U.S. Federal Specification WW-H-171 (Type 1), Manufacturers Standardization Society (MSS) SP-58 (Type 1)



Material: Steel



Part #	Description	F		Cert
Finish: Electrogalvanized, Pregalvanized				
4010050EG	1/2" Pipe, 0.84" OD, 3/8" Rod	600 lb	50 pc	cULus, ITB
4010075EG	3/4" Pipe, 1.05" OD, 3/8" Rod	600 lb	50 pc	cULus, FM, ITB
4010100EG	1" Pipe, 1.315" OD, 3/8" Rod	600 lb	50 pc	cULus, FM, ITB
4010125EG	1 1/4" Pipe, 1.66" OD, 3/8" Rod	600 lb	50 pc	cULus, FM, ITB
4010150EG	1 1/2" Pipe, 1.9" OD, 3/8" Rod	600 lb	50 pc	cULus, FM, ITB
4010200EG	2" Pipe, 2.375" OD, 3/8" Rod	600 lb	50 pc	cULus, FM, ITB
4010250EG	2 1/2" Pipe, 2.875" OD, 1/2" Rod	1,130 lb	50 pc	cULus, FM, ITB
4010300EG	3" Pipe, 3.5" OD, 1/2" Rod	1,130 lb	25 pc	cULus, FM, ITB
4010350EG	3 1/2" Pipe, 4" OD, 1/2" Rod	1,130 lb	25 pc	cULus, FM
4010400EG	4" Pipe, 4.5" OD, 5/8" Rod	1,130 lb	25 pc	cULus, FM, ITB
4010500EG	5" Pipe, 5.563" OD, 5/8" Rod	1,430 lb	20 pc	cULus, FM, ITB
4010600EG	6" Pipe, 6.625" OD, 3/4" Rod	1,940 lb	10 pc	cULus, FM, ITB
4010800EG	8" Pipe, 8.625" OD, 3/4" Rod	2,000 lb	10 pc	cULus, FM, ITB
4011000EG	10" Pipe, 10.75" OD, 7/8" Rod	3,600 lb	1 pc	ITB
4011200EG	12" Pipe, 12.75" OD, 7/8" Rod	3,800 lb	1 pc	ITB
4011400EG	14" Pipe, 14" OD, 1" Rod	4,200 lb	1 pc	ITB
4011600EG	16" Pipe, 16" OD, 1" Rod	4,600 lb	1 pc	ITB
4011800EG	18" Pipe, 18" OD, 1 1/8" Rod	4,800 lb	1 pc	ITB
4012000EG	20" Pipe, 20" OD, 1 1/4" Rod	4,800 lb	1 pc	ITB
4012400EG	24" Pipe, 24" OD, 1 1/4" Rod	4,800 lb	1 pc	ITB



# CLEVIS HANGERS

Part #	Description	F ↓		Cert
Finish: Hot-Dip Galvanized				
4010050HD	1/2" Pipe, 0.84" OD, 3/8" Rod	600 lb	50 pc	cULus
4010075HD	3/4" Pipe, 1.05" OD, 3/8" Rod	600 lb	50 pc	cULus, FM
4010100HD	1" Pipe, 1.315" OD, 3/8" Rod	600 lb	50 pc	cULus, FM
4010125HD	1 1/4" Pipe, 1.66" OD, 3/8" Rod	600 lb	50 pc	cULus, FM
4010150HD	1 1/2" Pipe, 1.9" OD, 3/8" Rod	600 lb	50 pc	cULus, FM
4010200HD	2" Pipe, 2.375" OD, 3/8" Rod	600 lb	50 pc	cULus, FM
4010250HD	2 1/2" Pipe, 2.875" OD, 1/2" Rod	1,130 lb	50 pc	cULus, FM
4010300HD	3" Pipe, 3.5" OD, 1/2" Rod	1,130 lb	25 pc	cULus, FM
4010400HD	4" Pipe, 4.5" OD, 5/8" Rod	1,130 lb	25 pc	cULus, FM
4010500HD	5" Pipe, 5.563" OD, 5/8" Rod	1,430 lb	20 pc	cULus, FM
4010600HD	6" Pipe, 6.625" OD, 3/4" Rod	1,940 lb	10 pc	cULus, FM
4010800HD	8" Pipe, 8.625" OD, 3/4" Rod	2,000 lb	10 pc	cULus, FM
4011000HD	10" Pipe, 10.75" OD, 7/8" Rod	3,600 lb	1 pc	-
4011200HD	12" Pipe, 12.75" OD, 7/8" Rod	3,800 lb	1 pc	-

A shield is recommended for insulated pipe applications to effectively distribute the load.

## 402 CLEVIS HANGER FOR COPPER TUBE, LIGHT DUTY

- Recommended for the suspension of stationary non-insulated copper tube lines
- Conforms with U.S. Federal Specification WW-H-171 (Type 12), Manufacturers Standardization Society (MSS) SP-58 (Type 1)



Material: Steel  
Finish: Copper Electroplated

Part #	Description	F ↓	
4020050CP	1/2" Pipe, 0.625" OD, 3/8" Rod	215 lb	50 pc
4020075CP	3/4" Pipe, 0.745" OD, 3/8" Rod	215 lb	50 pc
4020100CP	1" Pipe, 1.125" OD, 3/8" Rod	215 lb	50 pc
4020125CP	1 1/4" Pipe, 1.375" OD, 3/8" Rod	215 lb	50 pc
4020150CP	1 1/2" Pipe, 1.625" OD, 3/8" Rod	215 lb	50 pc
4020200CP	2" Pipe, 2.125" OD, 3/8" Rod	215 lb	50 pc
4020250CP	2 1/2" Pipe, 2.625" OD, 1/2" Rod	250 lb	30 pc
4020300CP	3" Pipe, 3.125" OD, 1/2" Rod	300 lb	25 pc
4020400CP	4" Pipe, 4.125" OD, 1/2" Rod	440 lb	25 pc

# CLEVIS HANGERS

## 403 CLEVIS HANGER WITH INSULATION SHIELD

- Recommended for the suspension of stationary insulated pipe lines



Material: Steel  
Finish: Electrogalvanized

Part #	Description	F ↓	☐
4030150EG	1 1/2" Shield, 1.9" OD, 3/8" Rod	600 lb	50 pc
4030200EG	2" Shield, 2.375" OD, 3/8" Rod	600 lb	50 pc
4030250EG	2 1/2" Shield, 2.875" OD, 3/8" Rod	1,130 lb	40 pc
4030300EG	3" Shield, 3.5" OD, 1/2" Rod	1,130 lb	25 pc
4030350EG	3 1/2" Shield, 4" OD, 1/2" Rod	1,130 lb	25 pc
4030400EG	4" Shield, 4.5" OD, 5/8" Rod	1,130 lb	15 pc
4030500EG	5" Shield, 5.563" OD, 5/8" Rod	1,430 lb	10 pc
4030600EG	6" Shield, 6.625" OD, 3/4" Rod	1,940 lb	5 pc
4030800EG	8" Shield, 8.625" OD, 3/4" Rod	2,000 lb	1 pc
4031000EG	10" Shield, 10.75" OD, 7/8" Rod	3,600 lb	1 pc
4031200EG	12" Shield, 12.75" OD, 7/8" Rod	3,800 lb	1 pc

Clevis Hangers

### Insulation Shield Size Chart for Iron Pipe

Nominal Iron Pipe Size	Insulation Thickness									
	1/2"	3/4"	1"	1 1/2"	2"	2 1/2"	3"	3 1/2"	4"	
1/2"	2"	2"	2 1/2"	3 1/2"	5"	6"	8"	-	-	
3/4"	2"	2 1/2"	2 1/2"	3 1/2"	5"	6"	8"	-	-	
1"	2"	2 1/2"	3"	4"	5"	6"	8"	-	-	
1 1/4"	2 1/2"	3"	3"	5"	5"	6"	8"	-	-	
1 1/2"	2 1/2"	3"	3 1/2"	5"	6"	8"	8"	-	-	
2"	3"	3 1/2"	4"	5"	6"	8"	8"	10"	-	
2 1/2"	3 1/2"	4"	5"	6"	8"	8"	10"	10"	-	
3"	4"	5"	5"	8"	8"	10"	10"	10"	12"	
3 1/2"	5"	5"	6"	8"	8"	10"	10"	12"	12"	
4"	5"	6"	6"	8"	8"	10"	10"	12"	12"	
5"	6"	8"	8"	8"	10"	10"	12"	12"	-	
6"	8"	8"	8"	10"	10"	12"	12"	-	-	
8"	10"	10"	10"	12"	12"	-	-	-	-	
10"	12"	12"	12"	-	-	-	-	-	-	

# CLEVIS HANGERS

## Insulation Shield Sizing Chart for Copper Tubing

Nominal Copper Tube Size	Insulation Thickness			
	1/2"	3/4"	1"	1 1/2"
1/2"	1 1/2"	1 1/2"	2 1/2"	3 1/2"
3/4"	2"	2"	2 1/2"	3 1/2"
7/8"	2"	2 1/2"	3"	3 1/2"
1"	2"	2 1/2"	3"	3 1/2"
1 1/4"	2"	2 1/2"	3"	4"
1 1/2"	2 1/2"	3"	3 1/2"	5"
2"	3"	3 1/2"	4"	5"
2 1/2"	3 1/2"	4"	4"	5"
3"	4"	5"	5"	6"
3 1/2"	5"	5"	6"	6"
4"	5"	5"	8"	8"
5"	6"	6"	8"	8"
6"	8"	8"	10"	10"

## 406 CLEVIS HANGER, STAINLESS STEEL

- Recommended for the suspension of stationary non-insulated stainless steel pipe lines
- Conforms with U.S. Federal Specification WW-H-171 (Type 1), Manufacturers Standardization Society (MSS) SP-58 (Type 1)



Material: Stainless Steel 304 (EN 1.4301)

Part #	Description	F ↓	📦	Cert
4060050S4	1/2" Pipe, 0.84" OD, 3/8" Rod	600 lb	50 pc	
4060075S4	3/4" Pipe, 1.05" OD, 3/8" Rod	600 lb	50 pc	
4060100S4	1" Pipe, 1.315" OD, 3/8" Rod	600 lb	50 pc	
4060125S4	1 1/4" Pipe, 1.66" OD, 3/8" Rod	600 lb	50 pc	
4060150S4	1 1/2" Pipe, 1.9" OD, 3/8" Rod	600 lb	50 pc	
4060200S4	2" Pipe, 2.375" OD, 3/8" Rod	610 lb	50 pc	
4060250S4	2 1/2" Pipe, 2.875" OD, 1/2" Rod	1,130 lb	25 pc	FM
4060300S4	3" Pipe, 3.5" OD, 1/2" Rod	1,130 lb	25 pc	FM
4060350S4	3 1/2" Pipe, 4" OD, 1/2" Rod	1,130 lb	25 pc	FM
4060400S4	4" Pipe, 4.5" OD, 5/8" Rod	1,130 lb	25 pc	FM
4060500S4	5" Pipe, 5.563" OD, 5/8" Rod	1,430 lb	20 pc	FM
4060600S4	6" Pipe, 6.625" OD, 3/4" Rod	1,940 lb	10 pc	FM
4060800S4	8" Pipe, 8.625" OD, 3/4" Rod	2,000 lb	10 pc	FM
4061000S4	10" Pipe, 10.75" OD, 7/8" Rod	3,600 lb	35 pc	
4061200S4	12" Pipe, 12.75" OD, 7/8" Rod	3,800 lb	30 pc	

# CLEVIS HANGERS

## 410 CLEVIS HANGER, LIGHT DUTY

- Recommended for the suspension of stationary non-insulated pipe lines
- Also commonly used for the suspension of insulated pipe lines
- Flared edges help prevent sharp surfaces from coming into contact with the pipe (1/2" to 8" pipe sizes)
- Clevis bottom pivots to allow pipe to be fed from either direction
- Conforms with U.S. Federal Specification WW-H-171 (Type 12), Manufacturers Standardization Society (MSS) SP-58 (Type 1)



Material: Steel  
Finish: Electrogalvanized, Pregalvanized



Part #	Description	F ↓		Cert
4100050EG	1/2" Pipe, 0.84" OD, 3/8" Rod	150 lb	50 pc	cULus
4100075EG	3/4" Pipe, 1.05" OD, 3/8" Rod	150 lb	50 pc	cULus
4100100EG	1" Pipe, 1.315" OD, 3/8" Rod	250 lb	50 pc	cULus, ITB
4100125EG	1 1/4" Pipe, 1.66" OD, 3/8" Rod	250 lb	50 pc	cULus, ITB
4100150EG	1 1/2" Pipe, 1.9" OD, 3/8" Rod	250 lb	50 pc	cULus, ITB
4100200EG	2" Pipe, 2.375" OD, 3/8" Rod	250 lb	50 pc	cULus, ITB
4100250EG	2 1/2" Pipe, 2.875" OD, 1/2" Rod	350 lb	50 pc	cULus, ITB
4100300EG	3" Pipe, 3.5" OD, 1/2" Rod	350 lb	25 pc	cULus, ITB
4100350EG	3 1/2" Pipe, 4" OD, 1/2" Rod	400 lb	25 pc	cULus
4100400EG	4" Pipe, 4.5" OD, 5/8" Rod	500 lb	25 pc	cULus, ITB
4100500EG	5" Pipe, 5.563" OD, 5/8" Rod	600 lb	25 pc	cULus, ITB
4100600EG	6" Pipe, 6.625" OD, 3/4" Rod	800 lb	10 pc	cULus, ITB
4100800EG	8" Pipe, 8.625" OD, 3/4" Rod	1,200 lb	10 pc	cULus, ITB

# Loop Hangers



Loop Hangers

## LOOP HANGERS

### 100 HEAVY DUTY LOOP HANGER

- Recommended for the suspension of stationary non-insulated pipe lines
- Conforms with Federal Specification WW-H-171 (Type 10), Manufacturers Standardization Society (MSS) SP-58 (Type 10)



Material: Steel  
Finish: Pregalvanized



Part #	Description	F	
1000500EG	5" Pipe, 5.563" OD, 5/8" Rod	1,100 lb	25 pc
1000600EG	6" Pipe, 6.625" OD, 3/4" Rod	1,250 lb	15 pc
1000800EG	8" Pipe, 8.625" OD, 7/8" Rod	1,250 lb	10 pc

### 100T HEAVY DUTY TRAPEZE LOOP HANGER

- Recommended for the suspension of stationary non-insulated pipe lines
- Designed for heavy duty trapeze installations where space is limited and attachment to structure is difficult
- UL® Listed to support trapeze assembly loads of 8" pipe size
- Conforms with Federal Specification WW-H-171 (Type 10), Manufacturers Standardization Society (MSS) SP-58 (Type 10)



Material: Steel  
Finish: Pregalvanized



Part #	Description	F	
100T0200EG	2" Pipe, 2 1/2" OD	1,250 lb	50 pc
100T0250EG	2 1/2" Pipe, 3" OD	1,250 lb	50 pc
100T0300EG	3" Pipe, 3 5/8" OD	1,250 lb	50 pc
100T0350EG	3 1/2" Pipe, 4 1/8" OD	1,250 lb	50 pc
100T0400EG	4" Pipe, 4 5/8" OD	1,250 lb	25 pc

Upper trapeze support and lower hanger must be able hold the maximum load intended for the trapeze assembly.

# LOOP HANGERS

## 101 LOOP HANGER FOR COPPER TUBE

- Recommended for the suspension of stationary non-insulated copper tube lines
- Conforms with Federal Specification WW-H-171 (Type 10), Manufacturers Standardization Society (MSS) SP-58 (Type 10)



Material: Steel  
Finish: Copper Electroplated, Electrogalvanized

Part #	Description	F ↓	☐
1010050CP	1/2" Pipe, 5/8" OD, 3/8" Rod	180 lb	100 pc
1010075CP	3/4" Pipe, 7/8" OD, 3/8" Rod	180 lb	100 pc
1010100CP	1" Pipe, 1 1/8" OD, 3/8" Rod	180 lb	100 pc
1010125CP	1 1/4" Pipe, 1 3/8" OD, 3/8" Rod	180 lb	100 pc
1010150CP	1 1/2" Pipe, 1 5/8" OD, 3/8" Rod	180 lb	100 pc
1010200CP	2" Pipe, 2 1/8" OD, 3/8" Rod	180 lb	100 pc
1010250CP	2 1/2" Pipe, 2 5/8" OD, 3/8" Rod	200 lb	100 pc
1010300CP	3" Pipe, 3 1/8" OD, 1/2" Rod	250 lb	50 pc
1010400CP	4" Pipe, 4 1/8" OD, 1/2" Rod	360 lb	50 pc

## 104 LOOP HANGER FOR PLASTIC PIPE

- Recommended for the suspension of stationary flexible EPDM or Polypropylene plastic piping
- Use hanger with V-trough (model VTR) for continuous support of flexible or hot piping services



Material: Steel  
Finish: Electrogalvanized

Part #	Description	F ↓	☐
1040100EG	1/2"-2" Pipe, 3/8" Rod	175 lb	50 pc
1040200EG	2 1/2"-4" Pipe, 1/2" Rod	175 lb	25 pc

## LOOP HANGERS

### 105 STAINLESS STEEL LOOP HANGER

- Recommended for the suspension of stationary stainless steel pipe lines
- Conforms with Federal Specification WW-H-171 (Type 7), Manufacturers Standardization Society (MSS) SP-58 (Type 7)

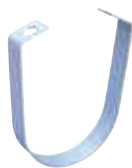

Material: Stainless Steel 304 (EN 1.4301)

Part #	Description	F ↓	☐
1050050S4	S304, 1/2" Pipe, 0.675" OD, 3/8" Rod	600 lb	100 pc
1050075S4	S304, 3/4" Pipe, 1.05" OD, 3/8" Rod	600 lb	100 pc
1050100S4	S304, 1" Pipe, 1.315" OD, 3/8" Rod	600 lb	100 pc
1050125S4	S304, 1 1/4" Pipe, 1.66" OD, 3/8" Rod	600 lb	100 pc
1050150S4	S304, 1 1/2" Pipe, 1.9" OD, 3/8" Rod	600 lb	100 pc
1050200S4	S304, 2" Pipe, 2.375" OD, 3/8" Rod	600 lb	50 pc
1050250S4	S304, 2 1/2" Pipe, 2.875" OD, 1/2" Rod	970 lb	50 pc
1050300S4	S304, 3" Pipe, 3.5" OD, 1/2" Rod	970 lb	50 pc
1050350S4	S304, 3 1/2" Pipe, 4" OD, 1/2" Rod	970 lb	1 pc
1050400S4	S304, 4" Pipe, 4.5" OD, 5/8" Rod	1,250 lb	25 pc
1050500S4	S304, 5" Pipe, 5.563" OD, 5/8" Rod	1,250 lb	25 pc
1050600S4	S304, 6" Pipe, 6.625" OD, 3/4" Rod	1,600 lb	10 pc
1050800S4	S304, 8" Pipe, 8.625" OD, 3/4" Rod	1,800 lb	10 pc

### INSERT NUT FOR LOOP HANGER

- Insert nut used to attach loop hanger to threaded rod



Material: Steel  
Finish: Electrogalvanized

Part #	Description	☐
100A0050EGP100	100, 101, 115, 116 Series, 1/2" Rod	100 pc
100N0037EGSP100	101, 115, 116 Series, 3/8" Rod	100 pc



# LOOP HANGERS

## 115 STANDARD DUTY LOOP HANGER

- Flared edges help prevent any sharp surfaces from coming into contact with the pipe (1/2" to 4" sizes)
- Retained insert nut helps ensure the loop hanger and insert nut stay together
- Recommended for the suspension of stationary non-insulated pipe lines
- Manufactured to use the minimum rod size permitted by NFPA® for fire sprinkler piping
- Conforms with Federal Specification WW-H-171 (Type 10), Manufacturers Standardization Society (MSS) SP-58 (Type 10)



Material: Steel  
Finish: Pregalvanized



Part #	Description	F		Cert
1150050EG	1/2" Pipe, 0.84" OD, 3/8" Rod	300 lb	100 pc	cULus
1150075EG	3/4" Pipe, 1.05" OD, 3/8" Rod	300 lb	100 pc	cULus, FM
1150100EG	1" Pipe, 1.315", 3/8" Rod	300 lb	100 pc	cULus, FM
1150125EG	1 1/4" Pipe, 1.66", 3/8" Rod	300 lb	100 pc	cULus, FM
1150150EG	1 1/2" Pipe, 1.9", 3/8" Rod	300 lb	100 pc	cULus, FM
1150200EG	2" Pipe, 2.375", 3/8" Rod	300 lb	100 pc	cULus, FM
1150250EG	2 1/2" Pipe, 2.875", 3/8" Rod	525 lb	50 pc	cULus, FM
1150300EG	3" Pipe, 3.5", 3/8" Rod	525 lb	50 pc	cULus, FM
1150350EG	3 1/2" Pipe, 4" OD, 3/8" Rod	585 lb	50 pc	cULus, FM
1150400EG	4" Pipe, 4.5", 3/8" Rod	650 lb	50 pc	cULus, FM
1150500EG	5" Pipe, 5.563" OD, 1/2" Rod	1,000 lb	25 pc	cULus, FM
1150600EG	6" Pipe, 6.625", 1/2" Rod	1,000 lb	20 pc	cULus, FM
1150800EG	8" Pipe, 8.625" OD, 1/2" Rod	1,000 lb	15 pc	cULus, FM

## LOOP HANGERS

### 115FL STANDARD DUTY LOOP HANGER, FELT LINED

- Flared edges help prevent sharp surfaces from coming into contact with the pipe
- Recommended for the suspension of stationary non-insulated copper tubing lines to prevent electrolysis
- Felt lining also acts to reduce noise in pipes
- Retained insert nut helps ensure the loop hanger and insert nut stay together
- Manufactured to use the minimum rod size permitted by NFPA® for fire sprinkler piping
- Conforms with Federal Specification WW-H-171 (Type 10), Manufacturers Standardization Society (MSS) SP-58 (Type 10)



Material: Steel  
Finish: Pregalvanized



Part #	Description	F ↓	📦	Cert
1150050FL	1/2" Pipe, 0.84" OD, 3/8" Rod	300 lb	100 pc	cULus
1150075FL	3/4" Pipe, 1.05" OD, 3/8" Rod	300 lb	100 pc	cULus, FM
1150100FL	1" Pipe, 1.315" OD, 3/8" Rod	300 lb	100 pc	cULus, FM
1150125FL	1 1/4" Pipe, 1.66" OD, 3/8" Rod	300 lb	100 pc	cULus, FM
1150150FL	1 1/2" Pipe, 1.9" OD, 3/8" Rod	300 lb	100 pc	cULus, FM
1150200FL	2" Pipe, 2.375" OD, 3/8" Rod	300 lb	100 pc	cULus, FM
1150250FL	2 1/2" Pipe, 2.875" OD, 3/8" Rod	525 lb	50 pc	cULus, FM
1150300FL	3" Pipe, 3.5" OD, 3/8" Rod	525 lb	50 pc	cULus, FM
1150400FL	4" Pipe, 4.5" OD, 3/8" Rod	650 lb	50 pc	cULus, FM

### 115 SURGE RESTRAINT

- Accommodates multiple sizes of 115 standard duty loop hangers
- Complies with NFPA® 13 standard by restricting the upward surge movement of activated fire sprinkler systems
- Grips the loop hanger, not the nut, allowing fine tuning for height adjustment
- Easily installs by hand before or after pipe is positioned in hanger



Material: Spring Steel  
Finish: nVent CADDY Armour



Part #	Description	📦
SR6	Surge Restraint, 1/2"-2" Pipe	100 pc

# LOOP HANGERS



## 116 LOOP HANGER, EPOXY COATED

- Recommended for the suspension of stationary non-insulated pipe lines
- Conforms with Federal Specification WW-H-171 (Type 10), Manufacturers Standardization Society (MSS) SP-58 (Type 10)



Material: Steel  
Finish: Epoxy Powder Coated



Part #	Description		
1160100EP	1" Pipe, 1.315" OD, 3/8" Rod	300 lb	100 pc
1160125EP	1 1/4" Pipe, 1.66" OD, 3/8" Rod	300 lb	100 pc
1160150EP	1 1/2" Pipe, 1.9" OD, 3/8" Rod	300 lb	100 pc
1160200EP	2" Pipe, 2.375" OD, 3/8" Rod	300 lb	100 pc
1160250EP	2 1/2" Pipe, 2.875" OD, 3/8" Rod	525 lb	50 pc
1160300EP	3" Pipe, 3.5" OD, 3/8" Rod	525 lb	50 pc
1160400EP	4" Pipe, 4" OD, 3/8" Rod	650 lb	25 pc
1160500EP	5" Pipe, 4.5" OD, 1/2" Rod	1,000 lb	25 pc
1160600EP	6" Pipe, 6.625" OD, 1/2" Rod	1,000 lb	15 pc
1160800EP	8" Pipe, 8.625" OD, 1/2" Rod	1,000 lb	10 pc

## LOOP HANGERS

### DROP-IN LOOP HANGER

- Once on the guide arm, the weight of the pipe opens the self-closing latch and effortlessly guides the pipe into place
- Integrated rubber sleeve is designed to provide additional grip when adjusting hanger height and reduce hanger rotation around the barrel nut
- Eliminates the need to disassemble the hanger during installation
- Allows prefabrication of complex assemblies with fittings and branch lines that previously could not be installed in one piece
- Designed to reduce overhead work for a safer, less strenuous installation
- Flared edges help prevent sharp surfaces from coming into contact with the pipe
- Retained insert nut helps ensure the loop hanger and insert nut stay together
- Manufactured to use the minimum rod size permitted by NFPA® for fire sprinkler piping
- Conforms with Federal Specification WW-H-171 (Type 10), Manufacturers Standardization Society (MSS) SP-58 (Type 10)



Material: Steel  
Finish: Electrogalvanized



Part #	Description	F ↓	📦
DH0100EG	1" Pipe, 1.315" OD, 3/8" Rod	300 lb	100 pc
DH0125EG	1 1/4" Pipe, 1.66" OD, 3/8" Rod	300 lb	100 pc
DH0150EG	1 1/2" Pipe, 1.9" OD, 3/8" Rod	300 lb	100 pc
DH0200EG	2" Pipe, 2.375" OD, 3/8" Rod	300 lb	100 pc

Installation Height represents the clearance distance needed from the loop hanger guide arm to structure to allow for installation of pipe.

### DH SURGE RESTRAINT

- Designed to work directly with the Drop-in Loop Hanger series
- Complies with NFPA® 13 standard by restricting the upward surge movement of activated fire sprinkler systems
- Easily installs by hand before or after pipe is positioned in hanger



Material: Steel  
Finish: Electrogalvanized



Part #	Description	📦
SR0100EG	1" Pipe	100 pc
SR0125EG	1 1/4" Pipe	100 pc
SR0150EG	1 1/2" Pipe	100 pc
SR0200EG	2" Pipe	100 pc

# Split Ring Hangers



# SPLIT RING HANGERS

## NVENT CADDY MACROFIX PLUS LF LOW-FRICTION

- Includes easy closing mechanism
- Age resistant lining designed specifically for plastic pipe applications
- Low-friction properties allow for expansion, contraction and easy sliding of pipe
- Conforms with Manufacturers Standardization Society (MSS) SP-58 (Type 12)
- Category II noise reduction according to DIN EN ISO 3822-1
- Compliant for sound insulation design according to DIN 4109



Material: Steel, EPDM-SBR Rubber  
 Finish: Electrogalvanized  
 Color: Green  
 Temperature: -58 to 230 °F

Part #	Description	F ↓	📦
4300050EG	0.787" OD, 1/2" Pipe, 20 mm Plastic Pipe	250 lb	100 pc
4300075EG	0.984" OD, 3/4" Pipe, 25 mm Plastic Pipe	250 lb	100 pc
4300100EG	1.26" OD, 1" Pipe, 32 mm Plastic Pipe	250 lb	100 pc
4300125EG	1.575" OD, 1 1/4" Pipe, 40 mm Plastic Pipe	250 lb	50 pc
4300150EG	1.902" OD, 1 1/2" Pipe, 50 mm Plastic Pipe	380 lb	50 pc
4300200EG	2.374" OD, 2" Pipe, 63 mm Plastic Pipe	380 lb	50 pc
4300250EG	2.874" OD, 2 1/2" Pipe, 75 mm Plastic Pipe	380 lb	25 pc
4300300EG	3.5" OD, 3" Pipe, 90 mm Plastic Pipe	380 lb	25 pc
4300350EG	4" OD, 3 1/2" Pipe, 100 mm Plastic Pipe	440 lb	25 pc
4300400EG	4.331" OD, 4" Pipe, 110 mm Plastic Pipe	440 lb	25 pc
4300500EG	5.512" OD, 5" Pipe	440 lb	25 pc

Lining is EPDM rubber.



## SPLIT RING HANGERS

### NVENT CADDY SUPERFIX 454 STANDARD DUTY

- Recommended for the suspension of stationary non-insulated pipe lines
- Easy-to-close clamp for steel pipe and copper tube
- Unique hinged design eliminates the need to disassemble the clamp prior to installation
- Clamp can be closed with one hand, without ever turning a screw
- All-steel design of the closing mechanism retains strength even when exposed to heat
- Comes with a welded 3/8" cap nut, allowing easy attachment to threaded rod
- Combo head bolt works with slotted, hex, or Phillips drivers
- Conforms with Manufacturers Standardization Society (MSS) SP-58 (Type 12)
- Category II noise reduction according to DIN EN ISO 3822-1
- Compliant for sound insulation design according to DIN 4109
- Reaction-to-fire classification is "E" in compliance with DIN EN 13501-1



Material: Steel, EPDM-SBR Rubber  
 Finish: Electrogalvanized  
 Temperature: -58 to 230 °F

Part #	Description		
454001	0.472"–0.551" OD, 1/4" Pipe, 3/8" Copper Tube	180 lb	100 pc
454002	0.591"–0.748" OD, 3/8" Pipe, 1/2" Copper Tube	180 lb	100 pc
454003	0.75"–0.828" OD, 5/8" Copper Tube	180 lb	100 pc
454004	0.827"–0.906" OD, 1/2" Pipe, 3/4" Copper Tube	180 lb	100 pc
454005	1.024"–1.102" OD, 3/4" Pipe, 1" Copper Tube	180 lb	100 pc
454006	1.26"–1.378" OD, 1" Pipe, 1 1/4" Copper Tube	180 lb	100 pc
454007	1.575"–1.693" OD, 1 1/4" Pipe, 1 1/2" Copper Tube	180 lb	50 pc
454008	1.89"–2.047" OD, 1 1/2" Pipe	180 lb	50 pc
454009	2.125"–2.283" OD, 2" Copper Tube	180 lb	50 pc
454010	2.244"–2.402" OD, 2" Pipe	180 lb	50 pc
454011	2.48"–2.638" OD, 2 1/2" Copper Tube	300 lb	25 pc
454012	2.744"–2.875" OD, 2 1/2" Pipe	300 lb	25 pc
454013	2.906"–3.156" OD, 3" Copper Tube	300 lb	25 pc
454014	3.268"–3.583" OD, 3" Pipe	300 lb	25 pc
454015	3.625"–3.937" OD, 3 1/2" Copper Tube	300 lb	25 pc
454016	3.976"–4.173" OD, 3 1/2" Pipe, 4" Copper Tube	300 lb	25 pc
454017	4.252"–4.488" OD, 4" Pipe	300 lb	25 pc

Lining is EPDM rubber.

## SPLIT RING HANGERS

### NVENT CADDY MACROFIX PLUS NI EZ WITH EASY CLOSURE

- Contains easy closing mechanism
- Plastic washers help prevent crushing the CPVC or plastic pipe and assure a floating fit
- Flared edges and specially designed welding area help protect CPVC piping
- Ideal for installations where space is limited and require services to be ran close to the attachment surface
- Suitable for 3/4" - 2" (20 - 50 DN) steel sprinkler pipe
- Eliminates the need to seismically brace when drops are kept within 6" (150 mm) of the attachment surface
- Combo head bolt works with slotted, hex, or Phillips drivers
- Conforms with Manufacturers Standardization Society (MSS) SP-58 (Type 12)
- Meets the UL® 203 stringent upward thrust requirement
- UL® Listed as both a hanger and pipe restrainer



Material: Steel  
Finish: Electrogalvanized



Part #	Description	F ↓	📦	Cert
4290050EG	1/2" Pipe, 0.787"-0.84" OD, 3/8" Rod	250 lb	100 pc	cULus
4290075EG	3/4" Pipe, 0.984"-1.059" OD, 3/8" Rod	250 lb	100 pc	cULus, FM
4290100EG	1" Pipe, 1.26"-1.327" OD, 3/8" Rod	250 lb	100 pc	cULus, FM
4290125EG	1 1/4" Pipe, 1.575"-1.669" OD, 3/8" Rod	250 lb	50 pc	cULus, FM
4290150EG	1 1/2" Pipe, 1.9"-1.969" OD, 3/8" Rod	320 lb	50 pc	cULus, FM
4290200EG	2" Pipe, 2.374"-2.48" OD, 3/8" Rod	320 lb	50 pc	cULus, FM
4290250EG	2 1/2" Pipe, 2.875"-2.996" OD, 3/8" Rod	320 lb	25 pc	cULus
4290300EG	3" Pipe, 3.5"-3.543" OD, 3/8" Rod	380 lb	25 pc	cULus
4290350EG	3 1/2" Pipe, 4"-4.106" OD, 3/8" Rod	440 lb	25 pc	-
4290400EG	4" Pipe, 4.331"-4.5" OD, 3/8" Rod	440 lb	25 pc	cULus
4290500EG	5" Pipe, 5.5"-5.563" OD, 3/8" Rod	440 lb	25 pc	-



# SPLIT RING HANGERS

## 455 MALLEABLE SPLIT RING HANGER

- Recommended for the suspension of stationary non-insulated pipe lines
- Allows for piping runs close to ceiling or walls
- Conforms with Federal Specification WW-H-171 (Type 25), Manufacturers Standardization Society (MSS) SP-58 (Type 12)



Material: Cast Iron

Part #	Description	F	
Finish: Electrogalvanized			
4550050EG	EG, 1/2" Pipe, 0.84" OD, 3/8" Rod	180 lb	25 pc
4550075EG	EG, 3/4" Pipe, 1.05" OD, 3/8" Rod	180 lb	25 pc
4550100EG	EG, 1" Pipe, 1.315" OD, 3/8" Rod	180 lb	25 pc
4550125EG	EG, 1 1/4" Pipe, 1.66" OD, 3/8" Rod	180 lb	25 pc
4550150EG	EG, 1 1/2" Pipe, 1.9" OD, 3/8" Rod	180 lb	25 pc
4550200EG	EG, 2" Pipe, 2.375" OD, 3/8" Rod	180 lb	25 pc
4550250EG	EG, 2 1/2" Pipe, 2.875" OD, 1/2" Rod	300 lb	50 pc
4550300EG	EG, 3" Pipe, 3.5" OD, 1/2" Rod	300 lb	50 pc
4550400EG	EG, 4" Pipe, 4.5" OD, 1/2" Rod	300 lb	25 pc
Finish: Plain			
4550050PL	1/2" Pipe, 0.84" OD, 3/8" Rod	180 lb	100 pc
4550075PL	3/4" Pipe, 1.05" OD, 3/8" Rod	180 lb	100 pc
4550100PL	1" Pipe, 1.315" OD, 3/8" Rod	180 lb	100 pc
4550125PL	1 1/4" Pipe, 1.66" OD, 3/8" Rod	180 lb	100 pc
4550150PL	1 1/2" Pipe, 1.9" OD, 3/8" Rod	180 lb	25 pc
4550200PL	2" Pipe, 2.375" OD, 3/8" Rod	180 lb	25 pc
4550250PL	2 1/2" Pipe, 2.875" OD, 1/2" Rod	300 lb	25 pc
4550300PL	3" Pipe, 3.5" OD, 1/2" Rod	300 lb	25 pc
4550400PL	4" Pipe, 4.5" OD, 1/2" Rod	300 lb	25 pc

Bolt and rivet are carbon steel.

## SPLIT RING HANGERS

### 456 MALLEABLE SPLIT RING HANGER FOR COPPER TUBE

- Recommended for the suspension of stationary non-insulated copper tube lines
- Allows for piping runs close to ceiling or walls
- Conforms with Federal Specification WW-H-171 (Type 25), Manufacturers Standardization Society (MSS) SP-58 (Type 12)



Material: Cast Iron

Finish: Copper Electroplated

Part #	Description	F ↓	📦
4560037CP	3/8" Copper Tube, 1/2" OD, 3/8" Rod	180 lb	100 pc
4560050CP	1/2" Copper Tube, 5/8" OD, 3/8" Rod	180 lb	100 pc
4560075CP	3/4" Copper Tube, 7/8" OD, 3/8" Rod	180 lb	100 pc
4560100CP	1" Copper Tube, 1 1/8" OD, 3/8" Rod	180 lb	25 pc
4560125CP	1 1/4" Copper Tube, 1 3/8" OD, 3/8" Rod	180 lb	25 pc
4560150CP	1 1/2" Copper Tube, 1 5/8" OD, 3/8" Rod	180 lb	25 pc
4560200CP	2" Copper Tube, 2 1/8" OD, 3/8" Rod	180 lb	25 pc
4560250CP	2 1/2" Copper Tube, 2 5/8" OD, 1/2" Rod	180 lb	50 pc
4560300CP	3" Copper Tube, 3 1/8" OD, 1/2" Rod	180 lb	25 pc
4560400CP	4" Copper Tube, 4 1/8" OD, 1/2" Rod	180 lb	25 pc

Bolt and rivet are carbon steel.

### BH BELL HANGER PIPE CLAMP

- Mounting screw is recessed and has a pierce-point to penetrate metal studs



Material: Steel

Finish: Copper Electroplated

Part #	Description	📦
BH0050CP	1/2" Pipe, 0.84" OD, 1.6"	50 pc
BH0075CP	3/4" Pipe, 1.05" OD, 1.7"	50 pc
BH0100CP	1" Pipe, 1.315" OD, 1.75"	50 pc

# Riser Clamps

Riser Clamps



# RISER CLAMPS

## 510 NVENT CADDY EZ RISER

- Recommended for suspending vertical steel pipe risers
- Slotted holes make assembly easy, eliminating loose hardware
- Serrated flange-head bolts eliminate need for wrenches on both bolt and nut
- Conforms with Federal Specification WW-H-171 (Type 8), Manufacturers Standardization Society (MSS) SP-58 (Type 8)



Part #	Description	F ↓	📦	Cert
Material: Stainless Steel 304 (EN 1.4301)				
5100050S4	S304, 1/2" Pipe, 0.84" OD	255 lb	25 pc	
5100075S4	S304, 3/4" Pipe, 1.05" OD	255 lb	25 pc	
5100100S4	S304, 1" Pipe, 1.315" OD	255 lb	25 pc	
5100125S4	S304, 1 1/4" Pipe, 1.66" OD	255 lb	25 pc	
5100150S4	S304, 1 1/2" Pipe, 1.9" OD	255 lb	25 pc	
5100200S4	S304, 2" Pipe, 2.375" OD	255 lb	25 pc	
5100250S4	S304, 2 1/2" Pipe, 2.875" OD	390 lb	25 pc	
5100300S4	S304, 3" Pipe, 3.5" OD	530 lb	25 pc	
5100400S4	S304, 4" Pipe, 4.5" OD	810 lb	10 pc	
5100500S4	S304, 5" Pipe, 5.563" OD	1,160 lb	10 pc	
5100600S4	S304, 6" Pipe, 6.625" OD	1,570 lb	300 pc	
5100800S4	S304, 8" Pipe, 8.625" OD	2,500 lb	1 pc	
5101000S4	S304, 10" Pipe, 10.75" OD	2,500 lb	1 pc	

# RISER CLAMPS

Part #	Description			Cert
Material: Steel – Finish: Electrogalvanized				
5100050EG	EG, 1/2" Pipe, 0.84" OD	255 lb	25 pc	
5100075EG	EG, 3/4" Pipe, 1.05" OD	255 lb	25 pc	
5100100EG	EG, 1" Pipe, 1.315" OD	255 lb	25 pc	
5100125EG	EG, 1 1/4" Pipe, 1.66" OD	255 lb	25 pc	
5100150EG	EG, 1 1/2" Pipe, 1.9" OD	255 lb	25 pc	
5100200EG	EG, 2" Pipe, 2.375" OD	255 lb	25 pc	cULus, ITB
5100250EG	EG, 2 1/2" Pipe, 2.875" OD	390 lb	25 pc	cULus, ITB
5100300EG	EG, 3" Pipe, 3.5" OD	530 lb	25 pc	cULus, ITB
5100350EG	EG, 3 1/2" Pipe, 4" OD	670 lb	20 pc	cULus
5100400EG	EG, 4" Pipe, 4.5" OD	810 lb	10 pc	cULus, ITB
5100500EG	EG, 5" Pipe, 5.563" OD	1,160 lb	10 pc	cULus
5100600EG	EG, 6" Pipe, 6.625" OD	1,570 lb	10 pc	cULus
5100800EG	EG, 8" Pipe, 8.625" OD	2,500 lb	1 pc	cULus
5101000EG	EG, 10" Pipe, 10.75" OD	2,500 lb	1 pc	
5101200EG	EG, 12" Pipe, 12.75" OD	2,700 lb	1 pc	
5101400EG	EG, 14" Pipe, 14" OD	2,700 lb	1 pc	
5101600EG	EG, 16" Pipe, 16" OD	2,900 lb	1 pc	
5101800EG	EG, 18" Pipe, 18" OD	2,900 lb	1 pc	
5102000EG	EG, 20" Pipe, 20" OD	2,900 lb	1 pc	
5102400EG	EG, 24" Pipe, 24" OD	2,900 lb	1 pc	
Material: Steel – Finish: Hot-Dip Galvanized				
5100050HD	HD, 1/2" Pipe, 0.84" OD	255 lb	25 pc	
5100100HD	HD, 1" Pipe, 1.315" OD	255 lb	25 pc	
5100125HD	HD, 1 1/4" Pipe, 1.66" OD	255 lb	25 pc	
5100150HD	HD, 1 1/2" Pipe, 1.9" OD	255 lb	25 pc	
5100200HD	HD, 2" Pipe, 2.375" OD	255 lb	25 pc	cULus
5100250HD	HD, 2 1/2" Pipe, 2.875" OD	390 lb	25 pc	cULus
5100300HD	HD, 3" Pipe, 3.5" OD	530 lb	25 pc	cULus
5100400HD	HD, 4" Pipe, 4.5" OD	810 lb	10 pc	cULus
5100500HD	HD, 5" Pipe, 5.563" OD	1,160 lb	10 pc	cULus
5100600HD	HD, 6" Pipe, 6.625" OD	1,570 lb	300 pc	cULus
5100800HD	HD, 8" Pipe, 8.625" OD	2,500 lb	1 pc	cULus

Clamp is fitted for steel pipe and should be installed below a coupling or shear lug, with bolts torqued to recommended value. Slotted holes and bolts for pipe sizes up to 12" only.

## RISER CLAMPS

### 511 NVENT CADDY EZ RISER FOR COPPER TUBE

- Recommended for suspending vertical type K or L copper tubing risers
- Conforms with Federal Specification WW-H-171 (Type 8), Manufacturers Standardization Society (MSS) SP-58 (Type 8)
- Slotted holes make assembly easy, eliminating loose hardware
- Bolts are accessible from the front, serrated washer head design means no wrench required on back side for tightening



Material: Steel

Finish: Copper Electroplated

Part #	Description	F ↓	
5110050CP	1/2" Pipe, 5/8" OD	75 lb	25 pc
5110075CP	3/4" Pipe, 7/8" OD	75 lb	25 pc
5110100CP	1" Pipe, 1 1/8" OD	120 lb	25 pc
5110125CP	1 1/4" Pipe, 1 3/8" OD	150 lb	25 pc
5110150CP	1 1/2" Pipe, 1 5/8" OD	150 lb	25 pc
5110200CP	2" Pipe, 2 1/8" OD	150 lb	25 pc
5110250CP	2 1/2" Pipe, 2 5/8" OD	300 lb	25 pc
5110300CP	3" Pipe, 3 1/8" OD	300 lb	25 pc
5110400CP	4" Pipe, 4 1/8" OD	300 lb	25 pc

Clamp is fitted for copper tube and should be installed below a coupling or shear lug, with bolts torqued to recommended value.

### 512 NVENT CADDY EZ RISER FOR CLOSE QUARTERS

- Innovative design eliminates loose hardware, simplifying installation
- Serrated flange-head bolts eliminate need for wrenches on both bolt and nut
- Short ears allow for use in spaces where full-sized risers do not fit
- Conforms with Federal Specification WW-H-171 (Type 8), Manufacturers Standardization Society (MSS) SP-58 (Type 8)



Material: Steel

Finish: Electrogalvanized



Part #	Description	F ↓	
5120100EG	1" Pipe, 1.315" OD	255 lb	25 pc
5120125EG	1 1/4" Pipe, 1.66" OD	255 lb	25 pc
5120150EG	1 1/2" Pipe, 1.9" OD	255 lb	25 pc
5120200EG	2" Pipe, 2.375" OD	255 lb	25 pc
5120250EG	2 1/2" Pipe, 2.875" OD	390 lb	25 pc
5120300EG	3" Pipe, 3.5" OD	530 lb	25 pc
5120400EG	4" Pipe, 4.5" OD	810 lb	20 pc
5120600EG	6" Pipe, 6.625" OD	1,570 lb	10 pc

# RISER CLAMPS

## NVENT CADDY EZ RISER

- One-piece hinge design comes out of the box ready to install
- Lack of loose hardware eliminates dropped or lost components, eliminating potential rework and speeding up installation
- Carriage bolts seat into clamp, eliminating the need for multiples tools when tightening
- Installs up to 60% faster than standard riser clamps and 45% faster than the industry-leading first generation EZ Riser
- Multi-functional clamp can be installed in several approved orientations, simplifying material handling
- Integrated second set of bolt holes allow the assembly to easily adapt from a riser clamp into a stand-off support
- In spaces where full-sized riser clamps do not fit, integrated score marks allow for easy removal of ears
- Retains listing when the ears are removed for close quarters, uniquely making the nVent CADDY EZ Riser capable of a listing in both installations
- Recommended for suspending vertical steel pipe risers
- No need to stock and use separate part families for standard and close quarter clamps to offer a full range of listed parts, reducing inventory by 38%
- Conforms with Federal Specification WW-H-171 (Type 8), Manufacturers Standardization Society (MSS) SP-58 (Type 8)



Material: Steel  
Finish: Electrogalvanized



Part #	Description	F	
EZR0050	1/2" Pipe	255 lb	25 pc
EZR0075	3/4" Pipe	255 lb	25 pc
EZR0100	1" Pipe	255 lb	25 pc
EZR0125	1 1/4" Pipe	255 lb	25 pc
EZR0150	1 1/2" Pipe	255 lb	25 pc
EZR0200	2" Pipe	255 lb	25 pc
EZR0250	2 1/2" Pipe	390 lb	25 pc
EZR0300	3" Pipe	530 lb	25 pc
EZR0350	3 1/2" Pipe	670 lb	20 pc
EZR0400	4" Pipe	810 lb	10 pc
EZR0500	5" Pipe	1,160 lb	10 pc
EZR0600	6" Pipe	1,570 lb	10 pc

Clamp is fitted for steel pipe and should be installed below a coupling or shear lug, with bolts torqued to recommended value. Use of a socket or driver is recommended for installation.

## RISER CLAMPS

### 520 NVENT CADDY EZ RISER, EPOXY COATED

- Recommended for suspending vertical steel pipe risers where it is undesirable to have the steel of the hanger in direct contact with the pipe
- Conforms with Federal Specification WW-H-171 (Type 8), Manufacturers Standardization Society (MSS) SP-58 (Type 8)
- Slotted holes make assembly easy, eliminating loose hardware
- Bolts are accessible from the front, serrated washer head design means no wrench required on back side for tightening



Material: Steel

Finish: Epoxy Powder Coated, ElectroGalvanized

Part #	Description	F ↓	
5200050EP	1/2" Pipe, 0.84" OD	255 lb	25 pc
5200075EP	3/4" Pipe, 1.05" OD	255 lb	25 pc
5200100EP	1" Pipe, 1.315" OD	255 lb	25 pc
5200125EP	1 1/4" Pipe, 1.66" OD	255 lb	25 pc
5200150EP	1 1/2" Pipe, 1.9" OD	255 lb	25 pc
5200200EP	2" Pipe, 2.375" OD	255 lb	25 pc
5200250EP	2 1/2" Pipe, 2.875" OD	390 lb	25 pc
5200300EP	3" Pipe, 3.5" OD	530 lb	25 pc
5200400EP	4" Pipe, 4.5" OD	810 lb	20 pc
5200500EP	5" Pipe, 5.563" OD	1,160 lb	10 pc
5200600EP	6" Pipe, 6.625" OD	1,570 lb	25 pc

Clamp is fitted for steel pipe and should be installed below a coupling or shear lug, with bolts torqued to recommended value.



# Pipe Fixings



Pipe Fixings

# PIPE FIXINGS

## TELESCOPING PLUMBING PREFAB BRACKET

Pipe Fixings

- Uniquely fixes 2 1/2" pipe into a standard 3 5/8" stud wall cavity
- Out-of-the-box in-wall solution for supporting supply and waste lines
- Includes an adjustable telescoping screw gun bracket that provides a mid-span support and accommodates non-standard stud spacing
- Multiple pilot holes in telescoping bracket
- Can be mounted to face or inside of stud
- Modular design can accommodate multiple pipe sizes of supply and waste lines
- Marked for easy identification of supply line offset
- Can mount pipe in all vertical or horizontal orientations
- Plastic bracket housing is non-corrosive and compatible with all varieties of pipe
- Additional Plumbing Prefab Bracket Clamps (PFBC) can be purchased separately for multiple supply line runs

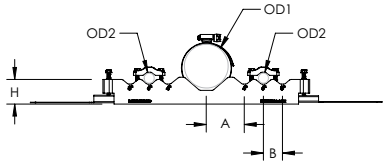
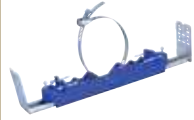

Material: Steel, Acrylonitrile Butadiene Styrene,  
Stainless Steel 410 (EN 1.4006)  
Finish: Pregalvanized, Electro galvanized  
Static Load Safety Factor: 3:1

Part #	Description	
PFB1624	15 3/4"-25" Stud Spacing, 1 1/8"-4 1/2" OD1, 0.375"-1.05" OD2	20 pc

# PIPE FIXINGS

## PLUMBING PREFAB BRACKET

- Out-of-the-box in-wall solution for supporting supply and waste lines
- Modular design can accommodate multiple pipe sizes of supply and waste lines
- Marked for easy identification of supply line offset
- Can mount pipe in all vertical or horizontal orientations
- Plastic bracket housing is non-corrosive and compatible with all varieties of pipe
- Additional Plumbing Prefab Bracket Clamps (PFBC) can be purchased separately for multiple supply line runs

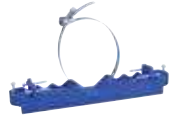

Material: Acrylonitrile Butadiene Styrene, Steel,  
Stainless Steel 410 (EN 1.4006)  
Finish: Pregalvanized, Electrogalvanized  
Static Load Safety Factor: 3:1

Part #	Description	
PFBNB	1 1/8"-4 1/2" OD1, 0.375"-1.05" OD2	20 pc

## PLUMBING PREFAB BRACKET CLAMP

- Clamps attach supply lines to the Plumbing Prefab Bracket
- Plastic clamping surface is non-corrosive and compatible with all varieties of pipe
- Multifunction screw with hexagonal combination head (slot and crosshead)
- Screws offer adequate clearance to prevent contact or damage to maximum diameter pipe



Material: Steel, Acrylonitrile Butadiene Styrene  
Finish: Electrogalvanized

Part #	Description	
PFBC	0.375"-1.05" OD	10 pc

## PIPE FIXINGS

### nVent CADDY SUPERKLIP

- Closes and locks automatically when the pipe, tube or cable is inserted
- One-piece clamp for fast and convenient installation
- Fasten with either wood screw, dual threaded screw with or without collar, nail with collar, threaded rod, mounting plate or shot-fire bracket



Material: Xenoy®  
Temperature: -13 to 194 °F

Part #	Description	F ↓	↓ Cube
389017	0.31"–0.37" OD, 1/4" Copper Tube	30 lb	100 pc
389018	0.37"–0.46" OD, 1/4" Copper Tube	33 lb	100 pc
389001	0.46"–0.56" OD, 3/8" Copper Tube	35 lb	100 pc
389002	Superklip, 0.56"–0.66", 1/2" Copper Tube	40 lb	100 pc
389003	0.66"–0.77" OD, 3/8" Rigid, 3/8" Pipe, 5/8" Copper Tube	43 lb	100 pc
389004	Superklip, 0.77"–0.86", 1/2" Rigid, 1/2" Copper Tube	50 lb	100 pc
389005	0.86"–0.98" OD, 3/4" Copper Tube	48 lb	100 pc
389006	0.98"–1.09" OD, 3/4" Rigid, 3/4" Pipe	54 lb	50 pc
389007	1.09"–1.23" OD, 1" Copper Tube	58 lb	50 pc
389008	1.23"–1.4" OD, 1" Rigid, 1" Pipe, 1 1/4" Copper Tube	67 lb	50 pc
389009	1.4"–1.56" OD, 1 1/4" Copper Tube	72 lb	50 pc
389011	1.56"–1.71" OD, 1 1/4" Rigid, 1 1/4" Pipe, 1 1/2" Copper Tube	80 lb	25 pc
389012	1.83"–2" OD, 1 1/2" Rigid, 1 1/2" Pipe	84 lb	25 pc
389013	2"–2.19" OD, 2" Copper Tube	90 lb	25 pc
389014	2.3"–2.52" OD, 2" Rigid, 2" Pipe	92 lb	20 pc

# PIPE FIXINGS

## **NVENT CADDY SUPERKLIP BP1 BASE PLATE FOR TWO CLIPS**

- Mounting plate accepts two SUPERKLIP clamps with outer diameters up to 1" (25 mm)



Material: Xenoy®

Part #	Description	
389015	3/16" Hole	50 pc

## **NVENT CADDY SUPERKLIP CA CONCRETE ATTACHMENT**

- Steel clip which fits in the side of the nVent CADDY Superklip
- Steel clip can be shot fired to concrete or steel



Material: Steel  
Finish: Electrogalvanized

Part #	Description	
389071	3/16" Hole	100 pc

Pipe Fixings

## PIPE FIXINGS

### nVent CADDY SWIFT CLIP THREADED ROD ATTACHMENT

- Snap-on and twist installation requires no tools
- Easily adjusts by rotating up or down on the threaded rod
- For support and positioning of refrigeration, A/C tubing, PEX piping, conduit and cabling
- Secures pipe and insulation without any breaks
- Compliant with UL® 2043 and suitable for use in air handling (plenum) spaces



Material: Polyamide  
Working Temperature: -40 to 284 °F

Part #	Description	
TRC062	5/8" OD, 1/2" Copper Tube, 3/8" Rod	25 pc
TRC075	3/4" OD, 5/8" Copper Tube, 3/8" Rod	25 pc
TRC087	7/8" OD, 3/4" Copper Tube, 1/2" Pipe, 3/8" Rod	25 pc
TRC100	1" OD, 3/4" Pipe, 3/8" Rod	25 pc
TRC112	1 1/8" OD, 1" Copper Tube, 3/8" Rod	25 pc
TRC125	1 1/4" OD, 1" Pipe, 3/8" Rod	25 pc
TRC137	1 3/8" OD, 1 1/4" Copper Tube, 3/8" Rod	25 pc
TRC150	1 1/2" OD, 3/8" Rod	25 pc
TRC162	1 5/8" OD, 1 1/2" Copper Tube, 3/8" Rod	25 pc
TRC200	2" OD, 3/8" Rod	25 pc
TRC212	2 1/8" OD, 2" Copper Tube, 3/8" Rod	25 pc

Clip must be installed with temperature at or above 14 °F (-10 °C).

### TPC TUBE AND PIPE CLAMP

- Positions pipe or tube in stud wall applications
- Flexible clamping design accommodates multiple supply line sizes using one clamp
- May be used with the nVent CADDY Telescoping Screw Gun Bracket (TSGB) for an adjustable pipe bracket and clamping system



Material: Nylon

Part #	Description	
TPC112	3/8"-1 1/8" OD	100 pc
TPC238	5/8"-2 3/8" OD	50 pc

# PIPE FIXINGS

## BOLT CLOSE PIPE CLAMP FOR COPPER TUBE

- Retained bolt and built-in nut means there are less parts to handle or drop
- Combo head bolt works with slotted, hex, #3 phillips or #2 robertson drivers



Material: Steel  
Finish: Copper Electroplated

Part #	Description	F ↓	☐
CD0B37CP	1/2" Copper Tube, 3/8" Hole	250 lb	100 pc
CD0BCP	1/2" Copper Tube, 1/4" Hole	250 lb	100 pc
CD1B37CP	3/4" Copper Tube, 3/8" Hole	250 lb	100 pc
CD1BCP	3/4" Copper Tube, 1/4" Hole	250 lb	100 pc
CD2.5B37CP	1 1/4" Copper Tube, 3/8" Hole	250 lb	100 pc
CD2.5BCP	1 1/4" Copper Tube, 1/4" Hole	250 lb	100 pc
CD2B37CP	1" Copper Tube, 3/8" Hole	250 lb	100 pc
CD2BCP	1" Copper Tube, 1/4" Hole	250 lb	100 pc
CD3B37CP	1 1/2" Copper Tube, 3/8" Hole	350 lb	100 pc
CD3BCP	1 1/2" Copper Tube, 1/4" Hole	350 lb	100 pc
CD5B37CP	2" Copper Tube, 3/8" Hole	350 lb	50 pc
CD5BCP	2" Copper Tube, 5/16" Hole	350 lb	50 pc

## PIPE FIXINGS

### TWO HOLE PIPE STRAP

- Light duty support of pipe
- Attaches directly to the face of a horizontal or vertical structural member
- Conforms with Federal Specification WW-H-171 (Type 26), Manufacturers Standardization Society (MSS) SP-58 (Type 26)

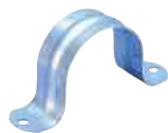

Material: Steel  
Finish: Electrogalvanized

Part #	Description	
0080050EG	1/2" Pipe, 0.84" OD	100 pc
0080075EG	3/4" Pipe, 1.05" OD	100 pc
0080100EG	1" Pipe, 1.315" OD	100 pc
0080125EG	1 1/4" Pipe, 1.66" OD	100 pc
0080150EG	1 1/2" Pipe, 1.9" OD	50 pc
0080200EG	2" Pipe, 2.375" OD	50 pc
0080250EG	2 1/2" Pipe, 2.875" OD	50 pc
0080300EG	3" Pipe, 3.5" OD	50 pc
0080400EG	4" Pipe, 4.5" OD	50 pc

### ONE HOLE STRAP FOR PIPE AND CONDUIT

- Recommended for supporting horizontal runs of piping from the face of a structural member
- Fastening hole in strap may be above or below pipe



Material: Steel  
Finish: Pregalvanized

Part #	Description	
0070050EG	0.84" OD, 1/2" Rigid, 1/2" Pipe	100 pc
0070075EG	1.05" OD, 3/4" Rigid, 3/4" Pipe	100 pc
0070100EG	1.315" OD, 1" Rigid, 1" Pipe	100 pc
0070125EG	1.66" OD, 1 1/4" Rigid, 1 1/4" Pipe	100 pc
0070150EG	1.9" OD, 1 1/2" Rigid, 1 1/2" Pipe	100 pc
0070200EG	2.375" OD, 2" Rigid, 2" Pipe	50 pc



## PIPE FIXINGS

### 800 EXTENDED PIPE STAY

- Used for water, heat or gas lines



Material: Steel  
Finish: Epoxy Powder Coated

Part #	Description	
800037050EP	3/8" Pipe, 1/2" Copper Tube, 0.685" OD	100 pc
800050075EP	1/2" Pipe, 3/4" Copper Tube, 0.921" OD	100 pc
800075100EP	3/4" Pipe, 1" Copper Tube, 1.165" OD	50 pc
800100125EP	1" Pipe, 1 1/4" Copper Tube, 1.417" OD	50 pc

Pipe Fixings

### 801 STANDARD PIPE STAY

- Used for water, heat or gas lines



Material: Steel  
Finish: Epoxy Powder Coated

Part #	Description	
801037050EP	0.685" OD, 3/8" Pipe, 1/2" Copper Tube	100 pc
801050075EP	0.921" OD, 1/2" Pipe, 3/4" Copper Tube	100 pc
801075100EP	1.165" OD, 3/4" Pipe, 1" Copper Tube	100 pc
801100125EP	1.417" OD, 1" Pipe, 1 1/4" Copper Tube	100 pc
801125150EP	1.732" OD, 1 1/4" Pipe, 1 1/2" Copper Tube	50 pc
801150000EP	1.953" OD, 1 1/2" Pipe	50 pc

## PIPE FIXINGS

### 150M STANDARD U-BOLT

- Pipe support for general piping applications
- Comes complete with 4 nuts (2 installed on each end)
- Conforms with Federal Specification WW-H-171 (Type 24), Manufacturers Standardization Society ANSI®/MSS-SP-58 (Type 24)



Part #	Description	F ↓	☐
<b>Material: Stainless Steel 304 (EN 1.4301)</b>			
150M0100S4	S304, 1" Pipe, 1.315" OD, 1/4" Rod	435 lb	100 pc
150M0125S4	S304, 1 1/4" Pipe, 1.66" OD, 3/8" Rod	1,090 lb	100 pc
150M0150S4	S304, 1 1/2" Pipe, 1.9" OD, 3/8" Rod	1,090 lb	100 pc
150M0200S4	S304, 2" Pipe, 2.375" OD, 3/8" Rod	1,090 lb	50 pc
150M0250S4	S304, 2 1/2" Pipe, 2.875" OD, 1/2" Rod	2,020 lb	50 pc
150M0300S4	S304, 3" Pipe, 3.5" OD, 1/2" Rod	2,020 lb	50 pc
150M0400S4	S304, 4" Pipe, 4.5" OD, 1/2" Rod	2,020 lb	50 pc
150M0500S4	S304, 5" Pipe, 5.563" OD, 1/2" Rod	2,020 lb	25 pc
150M0600S4	S304, 6" Pipe, 6.625" OD, 5/8" Rod	3,230 lb	20 pc
150M0800S4	S304, 8" Pipe, 8.625" OD, 5/8" Rod	3,230 lb	200 pc
150M1000S4	S304, 10" Pipe, 10.75" OD, 3/4" Rod	4,830 lb	200 pc
150M1200S4	S304, 12" Pipe, 12.75" OD, 7/8" Rod	6,730 lb	50 pc
<b>Material: Steel – Finish: Electrogalvanized</b>			
150M0100EG	EG, 1" Pipe, 1.315" OD, 1/4" Rod	435 lb	100 pc
150M0125EG	EG, 1 1/4" Pipe, 1.66" OD, 3/8" Rod	1,090 lb	100 pc
150M0150EG	EG, 1 1/2" Pipe, 1.9" OD, 3/8" Rod	1,090 lb	100 pc
150M0200EG	EG, 2" Pipe, 2.375" OD, 3/8" Rod	1,090 lb	50 pc
150M0250EG	EG, 2 1/2" Pipe, 2.875" OD, 1/2" Rod	2,020 lb	50 pc
150M0300EG	EG, 3" Pipe, 3.5" OD, 1/2" Rod	2,020 lb	50 pc
150M0400EG	EG, 4" Pipe, 4.5" OD, 1/2" Rod	2,020 lb	50 pc
150M0500EG	EG, 5" Pipe, 5.563" OD, 1/2" Rod	2,020 lb	25 pc
150M0600EG	EG, 6" Pipe, 6.625" OD, 5/8" Rod	3,230 lb	20 pc
150M0800EG	EG, 8" Pipe, 8.625" OD, 5/8" Rod	3,230 lb	200 pc
150M1000EG	EG, 10" Pipe, 10.75" OD, 3/4" Rod	4,830 lb	200 pc
150M1200EG	EG, 12" Pipe, 12.75" OD, 7/8" Rod	6,730 lb	50 pc
<b>Material: Steel – Finish: Plain</b>			
150M0100PL	1" Pipe, 1.315" OD, 1/4" Rod	435 lb	100 pc
150M0125PL	1 1/4" Pipe, 1.66" OD, 3/8" Rod	1,090 lb	100 pc
150M0150PL	1 1/2" Pipe, 1.9" OD, 3/8" Rod	1,090 lb	100 pc
150M0200PL	2" Pipe, 2.375" OD, 3/8" Rod	1,090 lb	50 pc
150M0250PL	2 1/2" Pipe, 2.875" OD, 1/2" Rod	2,020 lb	50 pc
150M0300PL	3" Pipe, 3.5" OD, 1/2" Rod	2,020 lb	50 pc
150M0400PL	4" Pipe, 4.5" OD, 1/2" Rod	2,020 lb	50 pc
150M0500PL	5" Pipe, 5.563" OD, 1/2" Rod	2,020 lb	25 pc
150M0600PL	6" Pipe, 6.625" OD, 5/8" Rod	3,230 lb	20 pc
150M0800PL	8" Pipe, 8.625" OD, 5/8" Rod	3,230 lb	200 pc
150M1000PL	10" Pipe, 10.75" OD, 3/4" Rod	4,830 lb	200 pc
150M1200PL	12" Pipe, 12.75" OD, 7/8" Rod	6,730 lb	50 pc

## PIPE FIXINGS

### SNAP TO STUD TELESCOPING SCREW GUN BOX BRACKET

- Snap to stud function makes installation fast and easy, saving time and increasing productivity
- Self-leveling feature ensures the bracket is always square to the stud, for a consistent and professional installation
- Pre-configured for 2-1/8" deep boxes and only a simple adjustment needed for 1-1/2" deep boxes
- Can mount multiple boxes
- Requires only two screws to install



Material: Steel  
Finish: Pregalvanized



Pipe Fixings

Part #	Description	
TSGB1624S	Snap to Stud Telescoping Screw Gun Box Bracket	50 pc

### SCREW GUN BRACKET

- Can be pre-assembled by the contractor to allow for greater productivity at the job site
- Pre-set for studs widths



Material: Steel  
Finish: Plain



Part #	Description	
SGB16A	16" stud spacing	50 pc
SGB24A	24" Stud Spacing	50 pc

## PIPE FIXINGS

### TELESCOPING SCREW GUN BOX BRACKET

- Can mount multiple boxes
- Notched and marked for easy identification and bending
- Improved design with stamped inch markings and pilot holes accelerates precise box conduit mounting between studs
- Pilot holes allow easy box attachment with a screwdriver
- Requires only a screw gun to install
- Can be mounted to face or inside of stud
- Adjustable for non-standard stud spacing
- Interlocking tab prevents accidental disassembly
- Unique, one-piece, break apart design
- Reduces movement of the box when used with flexible conduit, ENT, MC, AC or non-metallic sheathed cable

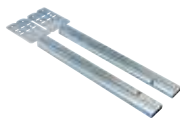

Material: Steel  
Finish: Pregalvanized



Part #	Description	
TSGB16	11"–18" stud space. 1 1/2", 2 1/8" box depth	50 pc
TSGB1624	15 3/4"–25" stud space. 1 1/2", 2 1/8", 2 1/2" box depth	50 pc
TSGB24	17"–26" stud space. 1 1/2", 2 1/8", 2 1/2" box depth	50 pc

# Pipe Fixings – CPVC



Pipe Fixings - CPVC

## PIPE FIXINGS – CPVC

### 107 WRAPAROUND STRAP FOR CPVC PIPE

- Includes flared edges to protect piping
- Rated for use with CPVC fire sprinkler pipe
- Includes mounting screw



Material: Steel  
Finish: Pregalvanized



Part #	Description	
1070075EG	3/4" Pipe, 1.05" OD	100 pc
1070100EG	1" Pipe, 1.315"	100 pc
1070125EG	1 1/4" Pipe, 1.66" OD	100 pc
1070150EG	1 1/2" Pipe, 1.9" OD	100 pc
1070200EG	2" Pipe, 2.375" OD	100 pc

Pipe Fixings - CPVC

### 108 TWO HOLE STRAP FOR CPVC PIPE

- Includes flared edges to protect piping
- Rated for use with CPVC fire sprinkler pipe
- Includes mounting screws



Material: Steel  
Finish: Pregalvanized



Part #	Description	
1080075EG	3/4" Pipe, 1.05" OD	100 pc
1080100EG	1" Pipe, 1.315"	100 pc
1080125EG	1 1/4" Pipe, 1.66" OD	100 pc
1080150EG	1 1/2" Pipe, 1.9" OD	100 pc
1080200EG	2" Pipe, 2.375" OD	100 pc

# PIPE FIXINGS – CPVC

## 109 SIDE MOUNT STRAP FOR CPVC PIPE

- Includes flared edges to protect piping
- Rated for use with CPVC fire sprinkler pipe
- Includes mounting screws

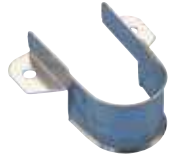

Material: Steel  
Finish: Pregalvanized



Part #	Description	
1090075EG	3/4" Pipe, 1.05" OD	100 pc
1090100EG	1" Pipe, 1.315" OD	100 pc
1090125EG	1 1/4" Pipe, 1.66" OD	100 pc
1090150EG	1 1/2" Pipe, 1.9" OD	100 pc
1090200EG	2" Pipe, 2.375" OD	100 pc

## DOSR DOUBLE OFFSET SURGE RESTRAINT FOR CPVC PIPE

- Provides quick and easy snap-in installation of pipe
- Built-in nail tab allows for fast, temporary mounting to any surface
- Rated for use with CPVC fire sprinkler pipe
- Positions pipe 1-1/2" (38 mm) out and up from the mounting surface eliminating the need for wooden spacer blocks
- Meets the UL® 203 stringent upward thrust requirement
- UL® Listed as both a hanger and restraint in the double offset orientation
- Complies with static load requirements of NFPA® 13
- Includes mounting screws
- Can be used with 3TW backing nut on composite wood joist installations



Material: Steel  
Finish: Pregalvanized



Part #	Description	
DOSR075	3/4" Pipe	100 pc
DOSR100	1" Pipe	100 pc

Pipe Fixings - CPVC

## PIPE FIXINGS – CPVC

### SOSR STAND OFF TWO HOLE STRAP FOR CPVC PIPE

- Includes flared edges to protect piping
- Rated for use with CPVC fire sprinkler pipe
- Positions pipe 1-1/2" (38 mm) off the mounting surface eliminating the need for wooden spacer blocks
- Can be mounted in both vertical and horizontal positions on concrete, steel and wood
- Meets the UL® 203 stringent upward thrust requirement
- UL® Listed as both a hanger and pipe restrainer
- Complies with static load requirements of NFPA® 13
- Includes mounting screws
- Can be used with 3TW backing nut on composite wood joist installations



Pipe Fixings - CPVC

Material: Steel  
Finish: Pregalvanized



Part #	Description	
SOSR075	3/4" Pipe	100 pc
SOSR100	1" Pipe	100 pc
SOSR125	1 1/4" Pipe	100 pc
SOSR150	1 1/2" Pipe	100 pc
SOSR200	2" Pipe	100 pc

### 3TW FASTENER

- Backing nut for use with SOSR and DOSR on composite wood joist installations
- Both a top and bottom backing nut is required for all surge restraint applications, while only a top backing nut is required for hanger applications



Material: Spring Steel  
Finish: nVent CADDY Armour

Part #	Description	
3TW	#10 Screw	100 pc



# PIPE FIXINGS – CPVC

## LATERAL TELESCOPING BRACE ASSEMBLY

- Complete, out of the box assembly is compatible with both steel (IPS) and CPVC piping
- Telescoping brace member eliminates the need to cut pipe, minimizing waste and allowing one person to effectively complete the installation
- Easy “push-to-install” nVent CADDY Rod Lock feature allows the V-bolt to assemble quickly, and helps eliminate the risk of compressing CPVC pipe
- Length of telescoping lateral brace is fixed by installing the included self-drilling screw
- Electrogalvanized coating throughout the entire assembly provides superior corrosion resistance, and eliminates the risk of exposing CPVC pipe to any harmful oils or residue
- Designed to reduce the installation time of a complete brace by up to 80%
- Design allows center loading of brace on the service pipe
- Meets requirements of NFPA® 13
- FM® Specification Tested
- Certified chemically compatible with CPVC piping systems
- Meets CEN/TS 17551:2021 requirements for Seismic Sway Bracing



Material: Steel  
Finish: Electrogalvanized



Pipe Fixings - CPVC

Part #	Description	
CSBT1	1'–1 1/2' Brace Length	5 pc
CSBT2	1 1/2'–3' Brace Length	5 pc

UL Listed Load applies to Sch 40, Sch 10, Youngstown Tube Fire-Flo (1-1/2" to 4"), Bull Moose Eddy Flo (1-1/4" to 4"), and Wheatland Mega Flow (1-1/4" to 4") service pipes. Wrench Size represents the hex size used to tighten the self-drilling screw.

Vertical Distance from Structure to Pipe Centerline Based on 45° Brace Angle				
Part #	Pipe Size			
	1"	2"	3"	4"
CSBT1	10" - 13"	10" - 13"	11" - 14"	11" - 14"
CSBT2	12" - 22"	12" - 23"	13" - 23"	13" - 24"

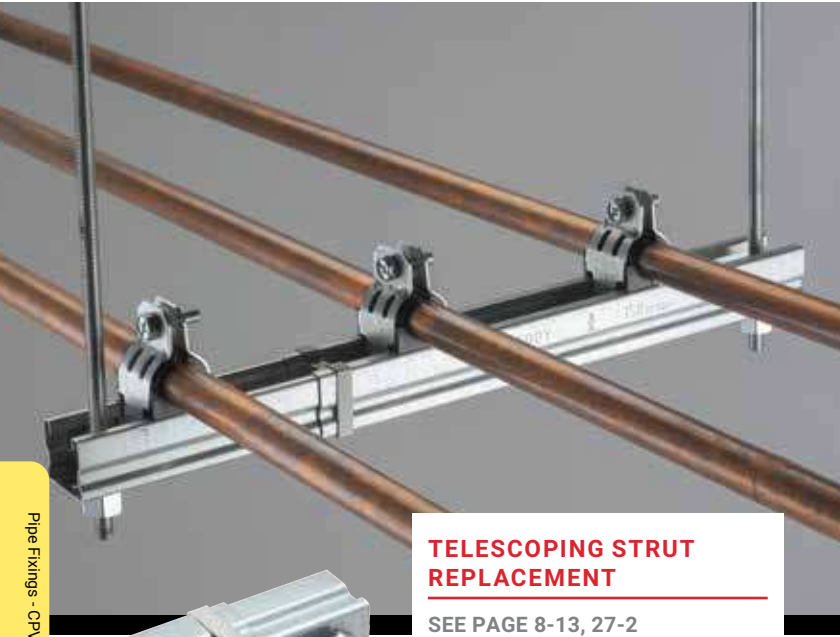

## TELESCOPING STRUT REPLACEMENT

SEE PAGE 8-13, 27-2

The Telescoping Strut Replacement is an innovative alternative to using traditional strut channels for trapeze or other support structures that accommodates standard strut fittings. This telescoping solution eliminates the need to handle and cut long lengths of strut to size. The bracket telescopes to the desired length and is locked in place by snapping closed a spring retainer clip.

- Standard strut profile runs the entire length of the part, allowing most standard fittings to be placed anywhere between the rods
- Spring steel retainer strap can be manually locked into place, allowing a tool-free installation
- Ready to use out of the box and eliminates the need for cutting sections of strut
- Pre-cut design is easier to transport and store than standard lengths of strut



With nVent CADDY Rod Lock Nut



With Nut



No Nut



Retrofit

# Strut Clamps



Strut Clamps

## STRUT CLAMPS

### RIGD SINGLE PIECE STRUT CLAMP FOR PIPE/RIGID CONDUIT

- One piece break apart strut clamp (1/2" thru 4" pipe size)
- Includes thread impression and captured screw (1/2" thru 4" pipe size)
- Fits into open side of strut channel
- Conforms with Manufacturers Standardization Society (MSS) SP-58 (Type 59)



Part #	Description	F ↓	☐
Material: Stainless Steel 304 (EN 1.4301)			
RIGD0050S4	S304, 1/2" Pipe, 0.84" OD	400 lb	100 pc
RIGD0075S4	S304, 3/4" Pipe, 1.05" OD	600 lb	100 pc
RIGD0100S4	S304, 1" Pipe, 1.315" OD	600 lb	100 pc
RIGD0125S4	S304, 1 1/4" Pipe, 1.66" OD	600 lb	50 pc
RIGD0150S4	S304, 1 1/2" Pipe, 1.9" OD	800 lb	50 pc
RIGD0200S4	S304, 2" Pipe, 2.375" OD	800 lb	50 pc
RIGD0250S4	S304, 2 1/2" Pipe, 2.875" OD	800 lb	25 pc
RIGD0300S4	S304, 3" Pipe, 3.5" OD	800 lb	25 pc
RIGD0400S4	S304, 4" Pipe, 4.5" OD	1,000 lb	25 pc
Material: Steel – Finish: Electrogalvanized			
RIGD0050EG	EG, 1/2" Pipe, 0.84" OD	400 lb	100 pc
RIGD0075EG	EG, 3/4" Pipe, 1.05" OD	600 lb	100 pc
RIGD0100EG	EG, 1" Pipe, 1.315" OD	600 lb	100 pc
RIGD0125EG	EG, 1 1/4" Pipe, 1.66" OD	600 lb	50 pc
RIGD0150EG	EG, 1 1/2" Pipe, 1.9" OD	800 lb	50 pc
RIGD0200EG	EG, 2" Pipe, 2.375" OD	800 lb	50 pc
RIGD0250EG	EG, 2 1/2" Pipe, 2.875" OD	800 lb	25 pc
RIGD0300EG	EG, 3" Pipe, 3.5" OD	800 lb	25 pc
RIGD0350EG	EG, 3 1/2" Pipe, 4" OD	1,000 lb	25 pc
RIGD0400EG	EG, 4" Pipe, 4.5" OD	1,000 lb	25 pc

## STRUT CLAMPS

### COPC SINGLE PIECE STRUT CLAMP FOR COPPER TUBE

- One piece break apart strut clamp
- Includes thread impression and captured screw
- Fits into open side of strut channel



Material: Steel  
Finish: Copper Electroplated

Part #	Description	F ↓	☐
COPC0050CP	1/2" Copper Tube, 5/8" OD	400 lb	100 pc
COPC0075CP	3/4" Copper Tube, 7/8" OD	400 lb	100 pc
COPC0100CP	1" Copper Tube, 1 1/8" OD	600 lb	100 pc
COPC0125CP	1 1/4" Copper Tube, 1 3/8" OD	600 lb	100 pc
COPC0150CP	1 1/2" Copper Tube, 1 5/8" OD	600 lb	100 pc
COPC0200CP	2" Copper Tube, 2 1/8" OD	800 lb	50 pc
COPC0250CP	2 1/2" Copper Tube, 2 5/8" OD	800 lb	50 pc
COPC0300CP	3" Copper Tube, 3 1/8" OD	800 lb	25 pc
COPC0350CP	3 1/2" Copper Tube, 3 5/8" OD	800 lb	25 pc
COPC0400CP	4" Copper Tube, 4 1/8" OD	1,000 lb	25 pc

### USC UNIVERSAL STRUT CLAMP FOR COPPER TUBE

- Consists of two clamps, nut and bolt
- Fits into open side of strut channel
- FM® Specification Tested  
(from 1/2" to 4" of Copper Tube Size)



Material: Steel  
Finish: Polyester

Part #	Description	F ↓	☐
USC010BR	0.38" OD, 1/4" Copper Tube	450 lb	100 pc
USC013BR	0.5"-0.54" OD, 3/8" Copper Tube	450 lb	100 pc
USC016BR	0.58"-0.63" OD, 1/2" Copper Tube	450 lb	100 pc
USC020BR	0.71"-0.79" OD, 5/8" Copper Tube	450 lb	100 pc
USC022BR	0.85"-0.88" OD, 3/4" Copper Tube	450 lb	100 pc
USC028BR	1.1"-1.14" OD, 1" Copper Tube	450 lb	100 pc
USC036BR	1.33"-1.5" OD, 1 1/4" Copper Tube	600 lb	100 pc
USC040BR	1.51"-1.6" OD	600 lb	100 pc
USC042BR	1.63"-1.67" OD, 1 1/2" Copper Tube	600 lb	50 pc
USC053BR	1.98"-2.11" OD	850 lb	50 pc
USC054BR	2.12"-2.17" OD, 2" Copper Tube	850 lb	50 pc
USC068BR	2.6"-2.72" OD, 2 1/2" Copper Tube	850 lb	50 pc
USC080BR	3.04"-3.25" OD, 3" Copper Tube	850 lb	25 pc
USC107BR	4.1"-4.33" OD, 4" Copper Tube	850 lb	25 pc
USC129BR	5"-5.13" OD, 5" Copper Tube	850 lb	25 pc
USC159BR	6.13"-6.38" OD, 6" Copper Tube	900 lb	25 pc

# STRUT CLAMPS

## nVENT CADDY SWIFT CLIP STRUT CLAMP FOR TUBE/PIPE

- Secures pipe while allowing it to expand, preventing cracked and fractured joints
- Snap-in and twist installation requires no tools
- Fits directly into vertical and horizontal strut channels
- Use for installation of refrigeration, A/C tubing and PEX piping in horizontal and vertical channels
- Compliant with UL® 2043 and suitable for use in air handling (plenum) spaces



Material: Polyamide  
Working Temperature: -40 to 284 °F

Part #	Description	
TSM0037	3/8" OD, 1/4" Copper Tube	100 pc
TSM0050	1/2" OD, 3/8" Copper Tube	100 pc
TSM0062	5/8" OD, 1/2" Copper Tube	100 pc
TSM0075	3/4" OD, 5/8" Copper Tube	100 pc
TSM0087	7/8" OD, 3/4" Copper Tube, 1/2" Pipe	100 pc
TSM0112	1 1/8" OD, 1" Copper Tube	50 pc
TSM0137	1 3/8" OD, 1 1/4" Copper Tube	50 pc
TSM0162	1 5/8" OD, 1 1/2" Copper Tube	50 pc

Can also be used with PEX piping. For PEX pipe sizes, refer to the Copper Tube Size column. Clip must be installed with temperature at or above 14 °F (-10 °C).

# STRUT CLAMPS

## NVENT CADDY SWIFT CLIP STRUT CLAMP FOR INSULATED TUBE/PIPE

- Secures pipe and insulation without a break, providing an uninterrupted vapor barrier seal which eliminates sweating on metal fittings
- Snap-in and twist installation requires no tools
- Fits directly into vertical and horizontal strut channels
- For support and positioning of refrigeration, A/C tubing, PEX piping, conduit and cabling
- Compliant with UL® 2043 and suitable for use in air handling (plenum) spaces



Material: Polyamide

Working Temperature: -40 to 284 °F

Part #	Description	
TSMI0062	5/8" OD, 1/2" Copper Tube	100 pc
TSMI0075	3/4" OD, 5/8" Copper Tube	100 pc
TSMI0087	7/8" OD, 3/4" Copper Tube, 1/2" Pipe	100 pc
TSMI0100	1" OD, 3/4" Pipe	100 pc
TSMI0112	1 1/8" OD, 1" Copper Tube	100 pc
TSMI0125	1 1/4" OD, 1" Pipe	50 pc
TSMI0137	1 3/8" OD, 1 1/4" Copper Tube	50 pc
TSMI0150	1 1/2" OD	50 pc
TSMI0162	1 5/8" OD, 1 1/2" Copper Tube	50 pc
TSMI0200	2" OD	25 pc
TSMI0212	2 1/8" OD, 2" Copper Tube	25 pc

Can also be used with PEX piping. For PEX pipe sizes, refer to the Copper Tube Size column. Clip must be installed with temperature at or above 14 °F (-10 °C).

Part #	Copper Tube with 3/8" Insulation	Copper Tube with 1/2" Insulation
TSMI0062	-	-
TSMI0075	-	-
TSMI0087	-	-
TSMI0100	1/4"	-
TSMI0112	3/8"	-
TSMI0125	1/2"	1/4"
TSMI0137	5/8"	3/8"
TSMI0150	7/8"	5/8"
TSMI0162	1 1/8"	3/4"
TSMI0200	-	7/8"
TSMI0212	1 3/8"	1 1/8"

Strut Clamps

## STRUT CLAMPS

### USC UNIVERSAL STRUT CLAMP FOR PIPE/CONDUIT

- Consists of two clamps, nut and bolt
- Fits into open side of strut channel
- Conforms with Manufacturers Standardization Society (MSS) SP-58 (Type 59)



Material: Steel

Part #	Description	F	
Finish: Electrogalvanized			
USC006EG	EG, 0.25" OD	450 lb	100 pc
USC010EG	EG, 0.38" OD	450 lb	100 pc
USC013EG	EG, 0.5"-0.54" OD	450 lb	100 pc
USC016EG	EG, 0.58"-0.63" OD, 3/8" EMT	450 lb	100 pc
USC017EG	EG, 0.65"-0.7" OD, 3/8" Pipe	450 lb	100 pc
USC020EG	EG, 0.71"-0.79" OD, 1/2" EMT	450 lb	100 pc
USC021EG	EG, 0.81"-0.84" OD, 1/2" Pipe	450 lb	100 pc
USC022EG	EG, 0.85"-0.88" OD	450 lb	100 pc
USC025EG	EG, 0.92"-1" OD, 3/4" EMT	450 lb	100 pc
USC026EG	EG, 1"-1.06" OD, 3/4" Pipe	450 lb	100 pc
USC028EG	EG, 1.1"-1.14" OD	450 lb	100 pc
USC031EG	EG, 1.16"-1.26" OD, 1" EMT	450 lb	100 pc
USC033EG	EG, 1.29"-1.32" OD, 1" Pipe	450 lb	100 pc
USC036EG	EG, 1.33"-1.5" OD	600 lb	50 pc
USC040EG	EG, 1.51"-1.6" OD, 1 1/4" EMT	600 lb	50 pc
USC042EG	EG, 1.63"-1.67" OD, 1 1/4" Pipe	600 lb	50 pc
USC046EG	EG, 1.69"-1.77" OD, 1 1/2" EMT	600 lb	50 pc
USC048EG	EG, 1.87"-1.97" OD, 1 1/2" Pipe	600 lb	50 pc
USC053EG	EG, 1.98"-2.11" OD	850 lb	50 pc
USC054EG	EG, 2.12"-2.17" OD	850 lb	50 pc
USC058EG	EG, 2.2"-2.25" OD, 2" EMT	850 lb	50 pc
USC060EG	EG, 2.34"-2.45" OD, 2" Pipe	850 lb	50 pc
USC063EG	EG, 2.45"-2.54" OD	850 lb	50 pc
USC068EG	EG, 2.6"-2.72" OD	850 lb	50 pc
USC073EG	EG, 2.75"-2.88" OD, 2 1/2" Pipe, 2 1/2" EMT	850 lb	50 pc
USC076EG	EG, 2.96"-3" OD	850 lb	25 pc
USC080EG	EG, 3.04"-3.25" OD	850 lb	25 pc
USC086EG	EG, 3.31"-3.5" OD, 3" Pipe, 3" EMT	850 lb	25 pc
USC093EG	EG, 3.54"-3.75" OD	850 lb	25 pc
USC101EG	EG, 3.87"-4.04" OD, 3 1/2" Pipe, 3 1/2" EMT	850 lb	25 pc



## STRUT CLAMPS

Part #	Description		
USC107EG	EG, 4.1"–4.33" OD	850 lb	25 pc
USC113EG	EG, 4.37"–4.54" OD, 4" Pipe, 4" EMT	850 lb	25 pc
USC121EG	EG, 4.63"–4.87" OD	850 lb	25 pc
USC129EG	EG, 5"–5.13" OD	850 lb	25 pc
USC135EG	EG, 5.25"–5.37" OD	850 lb	25 pc
USC143EG	EG, 5.5"–5.75" OD, 5" Pipe	900 lb	25 pc
USC152EG	EG, 5.87"–6.1" OD	900 lb	25 pc
USC159EG	EG, 6.13"–6.38" OD	900 lb	25 pc
USC168EG	EG, 6.5"–6.75" OD, 6" Pipe	900 lb	25 pc
USC178EG	EG, 6.87"–7.13" OD	900 lb	25 pc
USC191EG	EG, 7.5" OD	900 lb	25 pc
USC200EG	EG, 7.75"–8" OD	900 lb	25 pc
USC208EG	EG, 8.04"–8.37" OD	900 lb	25 pc
USC218EG	EG, 8.5"–8.63" OD, 8" Pipe	900 lb	25 pc
USC228EG	EG, 8.86"–9.1" OD	900 lb	25 pc
USC254EG	EG, 9.84"–10.13" OD	900 lb	25 pc
USC277EG	EG, 10.7"–11.02" OD, 10" Pipe	900 lb	25 pc
USC324EG	EG, 12.75" OD, 12" Pipe	900 lb	10 pc
USC400EG	EG, 15.75" OD	900 lb	10 pc
<b>Finish: Hot-Dip Galvanized</b>			
USC017HD	HD, 0.65"–0.7" OD, 3/8" Pipe	450 lb	100 pc
USC020HD	HD, 0.71"–0.79" OD, 1/2" EMT	450 lb	100 pc
USC021HD	HD, 0.81"–0.84" OD, 1/2" Pipe	450 lb	100 pc
USC026HD	HD, 1"–1.06" OD, 3/4" Pipe	450 lb	100 pc
USC031HD	HD, 1.16"–1.26" OD, 1" EMT	450 lb	100 pc
USC033HD	HD, 1.29"–1.32" OD, 1" Pipe	450 lb	100 pc
USC040HD	HD, 1.51"–1.6" OD, 1 1/4" EMT	600 lb	100 pc
USC042HD	HD, 1.63"–1.67" OD, 1 1/4" Pipe	600 lb	100 pc
USC046HD	HD, 1.69"–1.77" OD, 1 1/2" EMT	600 lb	100 pc
USC048HD	HD, 1.87"–1.97" OD, 1 1/2" Pipe	600 lb	50 pc
USC054HD	HD, 2.12"–2.17" OD	850 lb	50 pc
USC058HD	HD, 2.2"–2.25" OD, 2" EMT	850 lb	50 pc
USC060HD	HD, 2.34"–2.45" OD, 2" Pipe	850 lb	50 pc
USC073HD	HD, 2.75"–2.88" OD, 2 1/2" Pipe, 2 1/2" EMT	850 lb	50 pc
USC086HD	HD, 3.31"–3.5" OD, 3" Pipe, 3" EMT	850 lb	25 pc
USC113HD	HD, 4.37"–4.54" OD, 4" Pipe, 4" EMT	850 lb	25 pc
USC143HD	HD, 5.5"–5.75" OD, 5" Pipe	900 lb	25 pc
USC168HD	HD, 6.5"–6.75" OD, 6" Pipe	900 lb	25 pc
USC218HD	HD, 8.5"–8.63" OD, 8" Pipe	900 lb	25 pc
USC277HD	HD, 10.7"–11.02" OD, 10" Pipe	900 lb	10 pc
USC324HD	HD, 12.75" OD, 12" Pipe	900 lb	10 pc

## STRUT CLAMPS

### **nVent CADDY CUSHION CLAMP INSULATED STRUT CLAMP FOR PIPE/TUBE**

- Fits into open side of strut channel
- Plastic cushion is hinged to spread apart for easy installation
- Reduces noise and absorbs shock by gripping the pipe/tube firmly
- Square neck of carriage bolt prevents over-tightening
- Nylon locknut prevents loosening under vibration
- FM® Specification Tested (from 3/8" to 4" of Copper Tube Size)



Material: Steel, Polypropylene

Finish: ElectroGalvanized

Part #	Description	
CCC0025	1/4" OD	25 pc
CCC0037	3/8" OD, 1/4" Copper Tube	25 pc
CCC0050	1/2" OD, 3/8" Copper Tube, 1/4" Pipe	25 pc
CCC0062	5/8" OD, 1/2" Copper Tube, 3/8" Pipe	25 pc
CCC0075	3/4" OD, 5/8" Copper Tube	25 pc
CCC0087	7/8" OD, 3/4" Copper Tube, 1/2" Pipe	25 pc
CCC0100	1" OD, 3/4" Pipe	25 pc
CCC0112	1 1/8" OD, 1" Copper Tube	25 pc
CCC0125	1 1/4" OD, 1" Pipe	20 pc
CCC0137	1 3/8" OD, 1 1/4" Copper Tube	10 pc
CCC0150	1 1/2" OD	10 pc
CCC0162	1 5/8" OD, 1 1/2" Copper Tube, 1 1/4" Pipe	10 pc
CCC0187	1 7/8" OD, 1 1/2" Pipe	10 pc
CCC0212	2 1/8" OD, 2" Copper Tube	10 pc
CCC0237	2 3/8" OD, 2" Pipe	10 pc
CCC0262	2 5/8" OD, 2 1/2" Copper Tube	10 pc
CCC0312	3 1/8" OD, 3" Copper Tube	5 pc
CCC0412	4 1/8" OD, 4" Copper Tube	5 pc
CCC0450	4 1/2" OD, 4" Pipe	5 pc

# STRUT CLAMPS

## SCH1 SINGLE PIECE STRUT CLAMP FOR CONDUIT

- One-piece conduit clamp
- No screws or bolts to drop
- Requires only a screwdriver or nutdriver for installation
- Fits into open side of strut channel



Material: Steel  
Finish: Electrogalvanized



Part #	Description	F ↓	☐
SCH8	1/2" EMT	200 lb	100 pc
SCH12	3/4" EMT, 1/2" Rigid/Pipe	200 lb	100 pc
SCH16	1" EMT, 3/4" Rigid/Pipe	200 lb	100 pc
SCH20	1 1/4" EMT, 1" Rigid/Pipe	200 lb	100 pc

## SCH2 SINGLE PIECE STRUT CLAMP FOR CABLE/CONDUIT

- One-piece cable/conduit clamp with protective boot
- No screws or bolts to drop
- Requires only a screwdriver or nutdriver for installation
- Fits into open side of strut channel
- FM® Specification Tested (from 1/2" to 4" of EMT Conduit Size)



Material: Steel  
Finish: Electrogalvanized



Part #	Description	F ↓	☐
SCH6B	0.1"-0.63" OD	200 lb	100 pc
SCH8B	0.34"-0.71" OD, 1/2" EMT	200 lb	100 pc
SCH12B	0.57"-0.92" OD, 3/4" EMT, 1/2" Rigid/Pipe	200 lb	100 pc
SCH16B	0.72"-1.16" OD, 1" EMT, 3/4" Rigid/Pipe	200 lb	100 pc
SCH20B	1"-1.51" OD, 1 1/4" EMT, 1" Rigid/Pipe	200 lb	100 pc
SCH24B	1.25"-1.74" OD, 1 1/2" EMT, 1 1/4" Rigid/Pipe	350 lb	100 pc
SCH32B	1.74"-2.2" OD, 2" EMT, 1 1/2" Rigid/Pipe	350 lb	100 pc
SCH40B	2"-2.38" OD, 2" Rigid/Pipe	350 lb	100 pc
SCH48B	2.38"-2.88" OD, 2 1/2" EMT, 2 1/2" Rigid/Pipe	350 lb	100 pc
SCH56B	2.72"-3.5" OD, 3" EMT, 3" Rigid/Pipe	350 lb	100 pc
SCH64B	3.25"-4" OD, 3 1/2" EMT, 3 1/2" Rigid/Pipe	350 lb	100 pc
SCH72B	3.85"-4.5" OD, 4" EMT, 4" Rigid/Pipe	350 lb	100 pc

Strut Clamps

## STRUT CLAMPS

### SK SINGLE PIECE STRUT CLAMP FOR CONDUIT

- One piece break apart strut clamp for EMT and Rigid conduit
- Includes thread impression and captured screw



Part #	Description	F ↓	Certifications
Material: Aluminum			
SK8ALA	1/2" EMT, 1/2" Rigid/Pipe	150 lb	-
SK12ALA	3/4" EMT, 3/4" Rigid/Pipe	150 lb	-
SK16ALA	1" EMT, 1" Rigid/Pipe	150 lb	-
SK20ALA	1 1/4" EMT, 1 1/4" Rigid/Pipe	150 lb	-
SK24ALA	1 1/2" EMT, 1 1/2" Rigid/Pipe	150 lb	-
SK32ALA	2" EMT, 2" Rigid/Pipe	150 lb	-
Finish: Electrogalvanized			
SK85I	EG, 1/2" EMT, 1/2" Rigid/Pipe	200 lb	cULus
SK125I	EG, 3/4" EMT, 3/4" Rigid/Pipe	200 lb	cULus
SK165I	EG, 1" EMT, 1" Rigid/Pipe	200 lb	cULus
SK205I	EG, 1 1/4" EMT, 1 1/4" Rigid/Pipe	200 lb	cULus
SK245I	EG, 1 1/2" EMT, 1 1/2" Rigid/Pipe	200 lb	cULus
SK325I	EG, 2" EMT, 2" Rigid/Pipe	200 lb	cULus
SK405I	EG, 2 1/2" EMT, 2 1/2" Rigid/Pipe	350 lb	cULus
SK485I	EG, 3" EMT, 3" Rigid/Pipe	350 lb	cULus
SK565I	EG, 3 1/2" EMT, 3 1/2" Rigid/Pipe	350 lb	cULus
SK645I	EG, 4" EMT, 4" Rigid/Pipe	350 lb	cULus

# nVent CADDY Rod Lock



nVent CADDY Rod Lock

# NVENT CADDY ROD LOCK THREADED ROD MOUNTING SYSTEM

## nVent CADDY Rod Lock Structural Attachments

### NVENT CADDY ROD LOCK BEAM CLAMP

- Prefabricated assemblies easily lift and lock into place, helping to save time and money
- Easy “push-to-install” design allows installers to simply push the threaded rod through the mounting hole, instantly holding it in position
- Lock nut can be finger tightened, locking the rod in place
- Works with slightly damaged threads and minor burrs on the threaded rod
- Conforms with Federal Specification WW-H-171 (Type 23), Manufacturers Standardization Society ANSI®/MSS-SP-58 (Type 19 and 23)



Material: Cast Iron  
Finish: Electrogalvanized



Part #	Description			
CRLB37EG	3/8" Rod, 0.125"–0.375" Flange	250 lb	500 lb	25 pc

For use on plain and electro zinc plated hardware only. Static Load 1 represents 1/8" to 3/16" (3 mm to 5 mm) flange thickness. Static Load 2 represents 1/4" to 3/8" (6 mm to 10 mm) flange thickness. Recognizing that torque wrenches are generally not used or available on many job sites, the setscrew should be tightened so it contacts the I-beam and then an additional 1/2 turn added.

# NVENT CADDY ROD LOCK THREADED ROD MOUNTING SYSTEM

## nVent CADDY Rod Lock Structural Attachments

### NVENT CADDY ROD LOCK BEAM CLAMP, THICK FLANGE

- Prefabricated assemblies easily lift and lock into place, helping to save time and money
- Easy “push-to-install” design allows installers to simply push the threaded rod through the mounting hole, instantly holding it in position
- Lock nut can be finger tightened, locking the rod in place
- Works with slightly damaged threads and minor burrs on the threaded rod
- Conforms with Federal Specification WW-H-171 (Type 23), Manufacturers Standardization Society ANSI/MSS-SP-58 (Type 19 and 23)



Material: Cast Iron  
Finish: Electrogalvanized



Part #	Description	F ↓	
CRLB50EG	1/2" Rod, 0.375"–0.75" Flange	1,100 lb	25 pc

For use on plain and electro zinc plated hardware only. FM® Approved in the bottom mount orientation only. Recognizing that torque wrenches are generally not used or available on many job sites, the setscrew should be tightened so it contacts the I-beam and then an additional 1/2 turn added.

# NVENT CADDY ROD LOCK THREADED ROD MOUNTING SYSTEM

## nVent CADDY Rod Lock Structural Attachments

### NVENT CADDY ROD LOCK BAR JOIST HANGER

- Easily installs from underneath the bar joist
- Easily installs on lower or upper truss chord of the bar joist
- Plastic protection cap prevents dirt or structural coatings from obstructing the “push-to-install” mechanism
- Prefabricated assemblies easily lift and lock into place, helping to save time and money
- Easy “push-to-install” design allows installers to simply push the threaded rod through the mounting hole, instantly holding it in position
- Works with slightly damaged threads and minor burrs on the threaded rod



Material: Steel  
Finish: Electrogalvanized  
Static Load Safety Factor: 3.5:1

Part #	Description		
CRLJ37EG	3/8" Rod	1,000 lb	25 pc

Wrench Size 1 represents hex nut size used to tighten to bar joist. Wrench Size 2 represents nVent CADDY Rod Lock hex nut size.



# NVENT CADDY ROD LOCK THREADED ROD MOUNTING SYSTEM

## nVent CADDY Rod Lock Structural Attachments



### NVENT CADDY ROD LOCK ANCHOR SCREW

- For use with concrete and solid brick
- Prefabricated assemblies easily lift and lock into place, helping to save time and money
- Works with slightly damaged threads and minor burrs on the threaded rod



Material: Steel  
Finish: Electrogalvanized



Part #	Description		
CRLA37EG	3/8" Rod, 2.875" x 1.25" x 0.875"	652 lb	25 pc
CRLA37EGR2	3/8" Rod, 2.875" x 1.25" x 0.875"	652 lb	20 x 2 pc

For use on plain and electro zinc plated hardware only. Tested in 3,000 psi (20.68 MPa) concrete and soft or hard wood with a 9/32" pilot hole.

### NVENT CADDY ROD LOCK ANCHOR SCREW DRIVE SOCKET

- Drive socket for quick installation of nVent CADDY Rod Lock Anchor Screw



Material: Steel

Part #	Description	
CRLAKITA	nVent CADDY Rod Lock Anchor Screw Drive Socket	10 pc

nVent CADDY Rod Lock

# NVENT CADDY ROD LOCK THREADED ROD MOUNTING SYSTEM

## nVent CADDY Rod Lock Structural Attachments

### NVENT CADDY ROD LOCK METAL DECKING PRESET ANCHOR

- Set in place through a drilled hole in the metal decking before the concrete is poured
- Eliminate overhead drilling into building structure – nVent CADDY Rod Lock Preset Anchors are cast in place
- Easy “push-to-install” design allows installers to simply push the threaded rod through the mounting hole, instantly holding it in position
- Can be used in lower and upper flute installations
- Works with slightly damaged threads and minor burrs on the threaded rod
- Prefabricated assemblies easily lift and lock into place, helping to save time and money
- Plastic flange acts as insert locator when the forms are removed
- Rated for cracked concrete per ICC-ES AC446 according to ICC-ES ESR-3864 evaluation report
- Suitable for seismic bracing according to ICC-ES ESR-3864 evaluation report



Material: Steel  
Finish: ElectroGalvanized



Part #	Description	F ↓	⊞
CRLM37EG	Quick 3/8" Metal Decking Preset Anchor with Push-to-Install Technology - 830LB	830 lb	25 pc
CRLM50EG	1/2" Rod	830 lb	25 pc

# NVENT CADDY ROD LOCK THREADED ROD MOUNTING SYSTEM

## nVent CADDY Rod Lock Structural Attachments

### **NVENT CADDY ROD LOCK METAL DECKING PRESET ANCHOR INSERT**

- Allows for the installation of leveled nVent CADDY Rod Lock Metal Decking Preset Anchors anywhere between the metal decking ribs
- Symmetrical design with two insert holes for each size of Rod Lock Metal Decking Preset Anchors
- Compatible with a very wide range of metal decking
- Rod Lock Metal Decking Preset Anchors can be easily inserted through the insert plate while maintaining a tight positioning of the anchor
- Holes on each end of the insert for fixing to metal deck with self-tapping screws or nail gun
- Quick and easy installation



Material: Steel  
Finish: Pregalvanized

Part #	Description	
CRLMIP	nVent CADDY Rod Lock Metal Decking Preset Anchor Insert	25 pc

# NVENT CADDY ROD LOCK THREADED ROD MOUNTING SYSTEM

## nVent CADDY Rod Lock Structural Attachments



### NVENT CADDY ROD LOCK PLYWOOD FORM PRESET ANCHOR

- Eliminate overhead drilling into building structure – nVent CADDY Rod Lock Preset Anchors are cast in place
- Nails hold the anchor in place during the pour and easily break off with a strike of a hammer once the plywood forms are removed
- Easy “push-to-install” design allows installers to simply push the threaded rod through the mounting hole, instantly holding it in position
- Works with slightly damaged threads and minor burrs on the threaded rod
- Prefabricated assemblies easily lift and lock into place, helping to save time and money
- Plastic flange acts as insert locator when the forms are removed
- Rated for cracked concrete per ICC-ES AC446 according to ICC-ES ESR-3864 evaluation report
- Suitable for seismic bracing according to ICC-ES ESR-3864 evaluation report



Material: Steel  
Finish: Electrogalvanized



Part #	Description		
CRLW37EG	3/8" Rod	1,407 lb	25 pc
CRLW50EG	1/2" Rod	1,618 lb	25 pc

nVent CADDY Rod Lock

# NVENT CADDY ROD LOCK THREADED ROD MOUNTING SYSTEM

## nVent CADDY Rod Lock Structural Attachments

### NVENT CADDY ROD LOCK L-BRACKET

- Easy “push-to-install” design allows installers to simply push the threaded rod through the mounting hole, instantly holding it in position
- Prefabricated assemblies easily lift and lock into place, helping to save time and money
- Multiple attachment holes support the use of either self-drilling screws or bolts, offering installation options for concrete, wood, and steel structures
- Lock nut can be finger tightened, locking the rod in place
- Integrated adjustment nut enables fine tuning the system height up or down
- Extremely useful in tight spaces where wrenches are difficult to use
- Conforms with Federal Specification WW-H-171 (Type 23), Manufacturers Standardization Society ANSI®/MSS-SP-58 (Type 19 and 23)



Material: Steel  
Finish: Electrogalvanized



Part #	Description	
CRL37EG	3/8" Rod	25 pc

Follow fastener manufacturer’s recommended shear and pull-out strength when fastening to the structure. Fastener not included. Install in accordance with applicable code.

nVent CADDY Rod Lock

## NVENT CADDY ROD LOCK THREADED ROD MOUNTING SYSTEM

### nVent CADDY Rod Lock Structural Attachments

#### NVENT CADDY ROD LOCK COUPLER

- Joins two sections of threaded rod by an easy “push-to-install” mechanism
- Can be easily installed at the end of a threaded rod, or to any existing male thread
- Plastic protection cap prevents dirt or structural coatings from obstructing the “push-to-install” mechanism
- Prefabricated assemblies easily lift and lock into place, helping to save time and money
- Works with slightly damaged threads and minor burrs on the threaded rod



Material: Steel  
Finish: Electrogalvanized  
Static Load Safety Factor: 3.5:1

Part #	Description		
CRLC37EG	3/8" Rod	1,000 lb	25 pc

Wrench Size 1 represents hex size used to tighten to threaded rod from structure. Wrench Size 2 represents nVent CADDY Rod Lock hex nut size.

#### NVENT CADDY ROD LOCK COUPLER WITH ROD

- Easily installs into any traditional structural threaded rod attachment
- Allows simple installation of threaded rod assemblies by an easy “push-to-install” mechanism
- Plastic protection cap prevents dirt or structural coatings from obstructing the “push-to-install” mechanism
- Prefabricated assemblies easily lift and lock into place, helping to save time and money
- Works with slightly damaged threads and minor burrs on the threaded rod



nVent CADDY Rod Lock

Material: Steel  
Finish: Electrogalvanized  
Static Load Safety Factor: 3.5:1

Part #	Description		
CRLC37L1	3/8" Rod	1,000 lb	25 pc

Wrench Size 1 represents hex nut size used to tighten to structural attachment. Wrench Size 2 represents nVent CADDY Rod Lock hex nut size.

# NVENT CADDY ROD LOCK THREADED ROD MOUNTING SYSTEM

## nVent CADDY Rod Lock Supports

### NVENT CADDY ROD LOCK BOTTOM-MOUNT DUCT BRACKET

- Ideal for modular assembly – allows attachment of brackets to sections of duct while safely on the ground
- Slotted holes in bracket allow for horizontal adjustment of the bracket relative to the duct
- Easy “push-to-install” design allows installers to simply push the threaded rod through the mounting hole, instantly holding it in position
- Ready to use out of the box and eliminates the need for cutting and preparing sections of strut, angle iron, or strap
- Integrated adjustment nut enables fine tuning the system height up or down
- Lock nut can be finger tightened, locking the rod in place
- Extremely useful in tight spaces where wrenches are difficult to use
- Includes self-tapping sheet metal screws to attach bracket to duct



Material: Steel  
Finish: Electrogalvanized



Part #	Description		
CRLD37BEG	3/8" Rod	650 lb	25 pc

# NVENT CADDY ROD LOCK THREADED ROD MOUNTING SYSTEM

## nVent CADDY Rod Lock Supports

### NVENT CADDY ROD LOCK STRUT

- Allows for the quick creation, installation, and adjustment of multi-level trapeze assemblies
- Ready to use out of the box and eliminates the need for cutting and preparing sections of strut
- Easy “push-to-install” design allows installers to simply push the threaded rod through the mounting hole, instantly holding it in position
- Integrated adjustment nut enables fine tuning the system height up or down
- Accommodates slight variances in rod-to-rod position of the trapeze
- No loose parts or special tools needed for installation
- Lock nut can be finger tightened, locking the rod in place
- Works with all accessories that fit standard A or C type strut channels



Material: Steel

Finish: Electrogalvanized, Pregalvanized

Part #	Description	F ↓	☐
Strut Type: A (1 5/8" x 1 5/8")			
CRLP237L14	A Strut, 3/8" Rod, 16"	2,668 lb	5 pc
CRLP237L18	A Strut, 3/8" Rod, 20"	2,075 lb	5 pc
CRLP237L22	A Strut, 3/8" Rod, 24"	1,698 lb	5 pc
CRLP237L26	A Strut, 3/8" Rod, 28"	1,437 lb	5 pc
CRLP237L38	A Strut, 3/8" Rod, 40"	983 lb	5 pc
CRLP237L50	A Strut, 3/8" Rod, 52"	642 lb	5 pc
CRLP250L14	A Strut, 1/2" Rod, 16"	2,668 lb	5 pc
CRLP250L18	A Strut, 1/2" Rod, 20"	2,075 lb	5 pc
CRLP250L22	A Strut, 1/2" Rod, 24"	1,698 lb	5 pc
CRLP250L26	A Strut, 1/2" Rod, 28"	1,437 lb	5 pc
CRLP250L38	A Strut, 1/2" Rod, 40"	983 lb	5 pc
CRLP250L50	A Strut, 1/2" Rod, 52"	642 lb	5 pc
Strut Type: C (13/16" x 1 5/8")			
CRLP137L14	C Strut, 3/8" Rod, 16"	789 lb	5 pc
CRLP137L18	C Strut, 3/8" Rod, 20"	613 lb	5 pc
CRLP137L22	C Strut, 3/8" Rod, 24"	494 lb	5 pc
CRLP137L26	C Strut, 3/8" Rod, 28"	354 lb	5 pc
CRLP137L38	C Strut, 3/8" Rod, 40"	166 lb	5 pc
CRLP150L14	C Strut, 1/2" Rod, 16"	789 lb	5 pc

Ultimate load ratings for nVent CADDY Rod Lock Strut assumes a uniformly distributed load and includes a hole factor of 0.92. It is based on the material yield and maximum allowable deflection; an additional Safety Factor of 2 is recommended. nVent CADDY Rod Lock Strut must be installed with the open side of the channel facing up. For indoor applications only.



# NVENT CADDY ROD LOCK THREADED ROD MOUNTING SYSTEM

## nVent CADDY Rod Lock Supports

### NVENT CADDY ROD LOCK TELESCOPING STRUT REPLACEMENT

- Easy “push-to-install” design allows installers to simply push the threaded rod through the mounting hole, instantly holding it in position
- Telescopes to the desired length and is locked in place by snapping closed a spring retainer clip
- Standard strut profile runs the entire length of the part, allowing most standard fittings to be placed anywhere between the rods
- Allows installers to prefabricate complex assemblies and quickly lift and lock them into place
- Lock nut can be finger tightened, locking the rod in place
- Allows for the quick creation, installation, and adjustment of multi-level trapeze assemblies
- Captive threaded nuts enable fastening to threaded rod supports without loose parts
- Integrated ruler displays space between hanger rods in inches and centimeters
- Supports up to seven 2” (50 DN) conduits, six 2” (50 DN) water filled pipes at 10’ (3 m) spacing, or up to 18” (450 mm) cable tray
- Conduit can be supported on the top and bottom, eliminating the need for double sided strut
- Conduit and pipe can be placed directly on the strut profile, saving vertical space in buildings with limited room for installation
- Meets requirements of the Buy American Act



Material: Steel  
Finish: Pregalvanized

Part #	Description			
TSR122038RL	3/8" Rod	300 lb	200 lb	20 pc

Static Load 1 represents a distributed load for 12" - 20" (300 - 500 mm) installations and a point load for 12" - 16" (300 - 400 mm) installations. Static Load 2 represents a point load for 16" - 20" (400 - 500 mm) installations.

nVent CADDY Rod Lock

# NVENT CADDY ROD LOCK THREADED ROD MOUNTING SYSTEM

## nVent CADDY Rod Lock Supports

### NVENT CADDY ROD LOCK CHANNEL NUT

- Provides fast universal attachment of threaded rod and hardware to standard strut profiles
- Can be used to prefabricate assemblies which can be quickly pushed onto previously installed threaded rods
- Works with slightly damaged threads and minor burrs on the threaded rod



Material: Cast Iron  
Finish: Electrogalvanized

Part #	Description	F	
CRLS37EG	Quick 3/8" Channel Nut with Push-to-Install Technology for Strut Channel - 750LB	750 lb	100 pc

For use on plain and electro zinc plated hardware only.

### NVENT CADDY ROD LOCK HEIGHT-ADJUSTABLE STRUT NUT

- Allows for the quick creation, installation, and adjustment of multi-level trapeze assemblies
- Installs in strut profiles without the need to insert fingers or tools into the strut
- Easy "push-to-install" design allows installers to simply push the threaded rod through the mounting hole, instantly holding it in position
- Integrated adjustment nut enables fine tuning the system height up or down
- Lock nut can be finger tightened, locking the rod in place
- Accommodates slight variances in rod-to-rod position of the trapeze
- Can be used to prefabricate assemblies which can be quickly pushed onto previously installed threaded rods
- Works with slightly damaged threads and minor burrs on the threaded rod



Material: Steel  
Finish: Electrogalvanized

Part #	Description	F1	F2	
CRLSL37EG	nVent CADDY Rod Lock Strut Nut, A Strut, 3/8" Rod	1,500 lb	900 lb	20 pc

Static Load 1 represents 12 GA strut channel type A. Static Load 2 represents 14 GA strut channel type C. Wrench Size 1 represents nVent CADDY Rod Lock hex nut size. Wrench Size 2 represents stem nut size. Must be installed with the open side of the strut channel facing up. nVent CADDY Rod Lock Strut Nuts must be installed at a minimum of 1" (25.4 mm) from both ends of the strut channel.

# NVENT CADDY ROD LOCK THREADED ROD MOUNTING SYSTEM

## nVent CADDY Rod Lock Hardware

### NVENT CADDY ROD LOCK NUT

- Easy “push-to-install” design allows installers to simply push the threaded rod through the mounting hole, instantly holding it in position
- Fast installation onto long threaded rods – push the nut in place instead of threading it up the rod
- Excellent alignment and easy fine adjustment by spinning the nut
- Extremely useful in tight spaces where wrenches are difficult to use

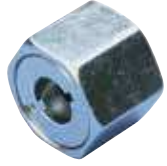

Material: Steel  
Finish: Electrogalvanized

Part #	Description	F ↓	📦
CRLN37EG	3/8" Rod	1,350 lb	25 pc

Static Load based on Grade 2 threaded rod.

### SN SERIES NUT

- Allows side mounting of nut to threaded rod
- Reduces the need for threading compared to standard nuts and washers
- Ideal for retrofit projects, such as trapeze installations, where disassembly of the support system is not desired
- Works with slightly damaged threads and minor burrs on the threaded rod
- Reduces installation time up to 50%



Material: Steel  
Finish: Electrogalvanized

Part #	Description	F ↓	📦
SN25	1/4" Rod	500 lb	100 pc
SN37	3/8" Rod	1,350 lb	100 pc
SN50	1/2" Rod	2,250 lb	100 pc

For use on plain and electro zinc plated hardware only.

# NVENT CADDY ROD LOCK THREADED ROD MOUNTING SYSTEM



## nVent CADDY Rod Lock Hardware

### SNSW FLANGED NUT

- Ideal for retrofit projects, such as trapeze installations, where disassembly of the support system is not desired
- Use as a stopper when installing nVent CADDY Rod Lock assemblies
- Can be easily installed, removed, and repositioned at any location along the threaded rod
- Ready to use out of the box and eliminates multiple pieces of standard hardware
- Functions as a hex nut and flat washer combined
- Washer is wide enough to work with standard strut channel profiles



Material: Steel  
Finish: Electrogalvanized  
Static Load Safety Factor: 3:1

Part #	Description		
SNSW37	3/8" Rod, 1.67" dia	300 lb	20 pc
SNSW50	1/2" Rod, 1.9" dia	300 lb	20 pc

For use on plain and electro zinc plated hardware only.

# Structural Attachments – Beam/Purlin



# STRUCTURAL ATTACHMENTS

## Beam/Purlin

### 300 UNIVERSAL BEAM CLAMP

- Conforms with Federal Specification WW-H-171 (Type 23), Manufacturers Standardization Society ANSI®/MSS-SP-58 (Type 19 and 23)



Material: Cast Iron



Part #	Description	F1	F2	Quantity	Cert
Finish: Electrogalvanized					
3000037EG	3/8" Rod, 3/4" Max Flange	500 lb	250 lb	100 pc	cULus, FM, VdS G4050085
3000050EG	1/2" Rod, 3/4" Max Flange	950 lb	760 lb	50 pc	cULus, FM
3000062EG	5/8" Rod, 3/4" Max Flange	950 lb	760 lb	50 pc	cULus
3000075EG	3/4" Rod, 3/4" Max Flange	950 lb	760 lb	50 pc	cULus
3000087EG	7/8" Rod, 3/4" Max Flange	950 lb	760 lb	50 pc	cULus
Finish: Plain					
3000037PL	3/8" Rod, 3/4" Max Flange	500 lb	250 lb	100 pc	cULus, FM
3000050PL	1/2" Rod, 3/4" Max Flange	950 lb	760 lb	50 pc	cULus, FM
3000062PL	5/8" Rod, 3/4" Max Flange	950 lb	760 lb	50 pc	cULus
3000075PL	3/4" Rod, 3/4" Max Flange	950 lb	760 lb	50 pc	cULus
3000087PL	7/8" Rod, 3/4" Max Flange	950 lb	760 lb	50 pc	cULus

Setscrew must be tightened and torqued onto the sloped side of the I-beam. Recognizing that torque wrenches are generally not used or available on many job sites, the setscrew should be tightened so it contacts the I-beam and then an additional 1/4 to 1/2 turn added.



Beam Clamps with nVent CADDY Rod Lock "push-to-install" technology for threaded rod applications are available on page 8-2.

- Prefabricated assemblies easily lift and lock into place, helping to save time and money
- Easy "push-to-install" design allows installers to simply push the threaded rod through the mounting hole, instantly holding it in position
- Lock nut can be finger tightened, locking the rod in place
- Works with slightly damaged threads and minor burrs on the threaded rod

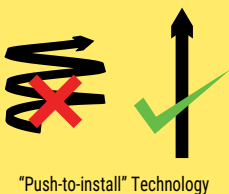

"Push-to-install" Technology

# STRUCTURAL ATTACHMENTS

## Beam/Purlin

### 310 UNIVERSAL BEAM CLAMP, THICK FLANGE

- Universal beam clamp for thick beams
- Conforms with Federal Specification WW-H-171 (Type 23), Manufacturers Standardization Society ANSI®/MSS-SP-58 (Type 19 and 23)



Material: Cast Iron



Part #	Description			
Finish: Electrogalvanized				
3100037EG	3/8" Rod, 1 1/4" Max Flange	500 lb	250 lb	50 pc
3100050EG	1/2" Rod, 1 1/4" Max Flange	950 lb	760 lb	50 pc
Finish: Plain				
3100037PL	3/8" Rod, 1 1/4" Max Flange	500 lb	250 lb	50 pc
3100050PL	1/2" Rod, 1 1/4" Max Flange	950 lb	760 lb	50 pc

Setscrew must be tightened and torqued onto the sloped side of the I-beam. Recognizing that torque wrenches are generally not used or available on many job sites, the setscrew should be tightened so it contacts the I-beam and then an additional 1/4 to 1/2 turn added.

### BC26 UNIVERSAL BEAM CLAMP WITH TAPPED HOLE

- One thru-hole for easier installation of threaded rod
- Conforms with Federal Specification WW-H-171 (Type 23), Manufacturers Standardization Society ANSI®/MSS-SP-58 (Type 19 and 23)



Material: Cast Iron

Finish: Electrogalvanized

Part #	Description			
BC260025EG	1/4" Rod, 13/16" Max Flange, 1/4" Hole	250 lb	100 lb	100 pc

Setscrew must be tightened and torqued onto the sloped side of the I-beam. Recognizing that torque wrenches are generally not used or available on many job sites, the setscrew should be tightened so it contacts the I-beam and then an additional 1/4 to 1/2 turn added.

# STRUCTURAL ATTACHMENTS

## Beam/Purlin

### 305 STAINLESS STEEL BEAM CLAMP, TOP MOUNT

- Pressed steel beam clamp
- Structural attachment to top flange of metal beams, purlins, channel, or angle iron
- Conforms with Federal Specification WW-H-171 (Type 23), Manufacturers Standardization Society ANSI@/MSS-SP-58 (Type 19)



Material: Stainless Steel 304 (EN 1.4301)



Part #	Description	F	
3050037S4	3/8" Rod, 5/8" Max Flange	500 lb	100 pc
3050050S4	1/2" Rod, 5/8" Max Flange	1,130 lb	100 pc

Set screw must be tightened and torqued onto the sloped side of the I-beam, channel, or angle iron flange. Recognizing that torque wrenches are generally not used or available on many job sites, the setscrew should be tightened so it contacts the I-beam and then an additional 1/4 to 1/2 turn added.

### SBC STAMPED BEAM CLAMP, TOP MOUNT

- Allows structural attachment to metal beams, bar joist, channel, or angle iron in top mount position only unless used on a parallel flange
- Lightweight, one-piece stamped body provides superior strength and eliminates deficiencies associated with castings
- Spins onto threaded rod and allows for easy adjustment
- Conforms with Federal Specification WW-H-171 (Type 23), Manufacturers Standardization Society ANSI@/MSS-SP-58 (Type 19)



Material: Steel  
Finish: Pregalvanized



Part #	Description	F	
SBC037	3/8" Rod, 3/4" Max Flange	500 lb	50 pc

Set screw must be tightened and torqued onto the sloped side of the I-beam, channel, or angle iron flange. Recognizing that torque wrenches are generally not used or available on many job sites, the setscrew should be tightened so it contacts the I-beam and then an additional 1/4 to 1/2 turn added.



# STRUCTURAL ATTACHMENTS

## Beam/Purlin

### BC BEAM CLAMP

- Easy installation to beam flanges



Material: Spring Steel  
Finish: nVent CADDY Armour



Part #	Description	F ↓	↓ Cube
BC	1/4" Rod 1, #10 Rod 2, 1/2" Max Flange	100 lb	100 pc

Setscrew must be tightened and torqued onto the sloped side of the I-beam.

### BC200/BC400 BEAM CLAMP

- Threaded hole on back and bottom



Material: Steel  
Finish: Electrogalvanized



Part #	Description	F ↓	↓ Cube
BC200	1/4" Rod, 0.5" Max Flange	100 lb	50 pc
BC400	3/8" Rod, 0.75" Max Flange	200 lb	25 pc

Setscrew must be tightened and torqued onto the sloped side of the I-beam.

# STRUCTURAL ATTACHMENTS

## Beam/Purlin

### BC10 MULTI-FUNCTION BEAM CLAMP

- Structural attachment to beams to support threaded rod



Material: Steel  
Finish: Electrogalvanized

Part #	Description			
BC100000EG	3/8", 1/2" Rod, 3/4" Max Flange	500 lb	300 lb	25 pc

Setscrew must be tightened and torqued onto the sloped side of the I-beam.

### BC10 BEAM CLAMP WITH BC15 SWIVEL

- Swivel attachment suitable for sloped beams



Material: Steel  
Finish: Electrogalvanized

Part #	Description		
BC101500EG	3/8", 1/2" Rod, 3/4" Max Flange	500 lb	25 pc

Setscrew must be tightened and torqued onto the sloped side of the I-beam. Recognizing that torque wrenches are generally not used or available on many job sites, the setscrew should be tightened so it contacts the I-beam and then an additional 1/4 to 1/2 turn added.

# STRUCTURAL ATTACHMENTS

## Beam/Purlin

### BC11/BC12 MULTI-FUNCTION CLAMP WITH J-BOLT

- Structural attachment to beams to support threaded rod
- J-bolt provides additional stability in high vibration environments



Material: Steel  
Finish: Electrogalvanized

Part #	Description			
BC110000EG	3/8", 1/2" Rod, 3/4" Max Flange	500 lb	300 lb	25 pc
BC120000EG	3/8", 1/2" Rod, 3/4" Max Flange	500 lb	300 lb	25 pc

Setscrew must be tightened and torqued onto the sloped side of the I-beam.

### BC13 WELDED BEAM CLAMP, STANDARD DUTY

- Structural attachment to beams to support threaded rod



Material: Steel  
Finish: Electrogalvanized

Part #	Description		
BC130025EG	1/4" Rod, 7/8" Max Flange	650 lb	20 pc
BC130037EG	3/8" Rod, 7/8" Max Flange	650 lb	20 pc
BC130050EG	1/2" Rod, 7/8" Max Flange	1,100 lb	20 pc

Setscrew must be tightened and torqued onto the sloped side of the I-beam. Recognizing that torque wrenches are generally not used or available on many job sites, the setscrew should be tightened so it contacts the I-beam and then an additional 1/4 to 1/2 turn added.

## STRUCTURAL ATTACHMENTS

### Beam/Purlin

#### BC14 WELDED BEAM CLAMP, HEAVY DUTY

- Structural attachment to beams to support threaded rod



Material: Steel

Finish: Electrogalvanized

Part #	Description	F ↓	↓ Cube
BC140037EG	3/8" Rod, 1 5/8" Max Flange	800 lb	20 pc
BC140050EG	1/2" Rod, 1 5/8" Max Flange	1,300 lb	20 pc
BC140062EG	5/8" Rod, 1 5/8" Max Flange	1,900 lb	10 pc

Setscrew must be tightened and torqued onto the sloped side of the I-beam. Recognizing that torque wrenches are generally not used or available on many job sites, the setscrew should be tightened so it contacts the I-beam and then an additional 1/4 to 1/2 turn added.

#### C-CLAMP

- Pressed steel beam clamp
- Conforms with Federal Specification WW-H-171 (Type 23), Manufacturers Standardization Society ANSI®/MSS-SP-58 (Type 23)



Material: Steel

Finish: Electrogalvanized

Static Load Safety Factor: 3.5:1

Part #	Description	F ↓	↓ Cube
2000037EG	EG, 3/8" Rod, 3/4" Max Flange	250 lb	100 pc

Setscrew must be tightened and torqued onto the sloped side of the I-beam. Recognizing that torque wrenches are generally not used or available on many job sites, the setscrew should be tightened so it contacts the I-beam and then an additional 1/4 to 1/2 turn added.

# STRUCTURAL ATTACHMENTS

## Beam/Purlin

### C-CLAMP FOR STRUT AND ROD

- Dual purpose beam clamp for rod and strut
- Conforms with Federal Specification WW-H-171 (Type 23), Manufacturers Standardization Society ANSI®/MSS-SP-58 (Type 23)



Material: Steel  
Finish: Pregalvanized



Part #	Description			Cert
200RS375	3/8" Rod, 5/8" Max Flange	250 lb	10 pc	cULus
200RS500	1/2" Rod, 5/8" Max Flange	360 lb	10 pc	

Setscrew must be tightened and torqued onto the sloped side of the I-beam. Load rating is per fastener with a 3X safety factor. Actual installation must be evaluated to determine load on the individual fastener. Recognizing that torque wrenches are generally not used or available on many job sites, the setscrew should be tightened so it contacts the I-beam and then an additional 1/4 to 1/2 turn added.

### RS RETROFIT RETAINER STRAP

- Ideal for both new and existing applications
- Can be installed without disassembly of the hanging system and/or removing the clamp
- Compatible with all standard nVent CADDY beam clamps and can be secured to either the set screw or threaded rod
- Large teardrop-shaped opening is compatible with multiple threaded rod diameters, reducing inventory by 50%
- Coined edge on teardrop-shaped opening locks into rod, eliminating shifting during install
- Provides a secure attachment in seismic zones and complies with NFPA® requirements
- Meets the UL® load test for retainer straps (3/8" and 1/2" rod sizes)



Material: Steel  
Finish: Pregalvanized



Part #	Description	
RS06	6 1/2"	100 pc
RS08	8 1/2"	100 pc
RS10	10 1/2"	100 pc
RS12	12 1/2"	100 pc
RS14	14 1/2"	100 pc
RS16	16 1/2"	100 pc
RS18	18 1/2"	50 pc

Add 2" to width of flange to determine minimum length strap required.

# STRUCTURAL ATTACHMENTS

## Beam/Purlin

### 35RS TWO HOLE RETAINER STRAP

- Retainer strap for beam clamps



Material: Steel  
Finish: Pregalvanized

Part #	Description	
035RS0600EG	6"	100 pc
035RS0800EG	8"	100 pc
035RS1000EG	10"	100 pc
035RS1200EG	12"	100 pc
035RS1400EG	14"	100 pc
035RS1600EG	16"	100 pc
035RS1800EG	18"	100 pc

Field bend and use jam nut over hanger rod to secure.

### BC09 RETAINER STRAP FOR BC13/14 SERIES

- Retainer strap for BC13/BC14 beam clamps



Material: Steel  
Finish: Electrogalvanized

Part #	Description	
BC090900EG	9"	50 pc
BC091200EG	12"	50 pc
BC091500EG	15"	25 pc

# STRUCTURAL ATTACHMENTS

## Beam/Purlin

### 360 ADJUSTABLE CENTER-LOAD BEAM CLAMP KIT

- Includes Series 26 Beam Clamp Extension Piece



Material: Steel, Cast Iron  
Finish: Plain

Part #	Description	F ↓	☐
3600037PL	3/8" Rod, 2" Max Pipe	600 lb	20 pc
3600050PL	1/2" Rod, 3 1/2" Max Pipe	1,130 lb	20 pc
3600062PL	5/8" Rod, 5" Max Pipe	1,365 lb	20 pc
3600075PL	3/4" Rod, 6" Max Pipe	1,365 lb	20 pc
3600087PL	7/8" Rod, 12" Max Pipe	1,365 lb	20 pc

Reduced hanger spacing is required when supporting 10" and 12" pipe. Install in accordance with applicable code.

### HAMMER-ON FLANGE CLIP, SIDE MOUNT

- Provides an attachment for wire, S-hooks, chain, nVent CADDY Speed Link or other assemblies to flanges and profiles
- Fits most beams
- Installs with just a hammer



Part #	Description	F ↓	☐	Cert
Material: Spring Steel — Finish: nVent CADDY Armour				
2H4	3/32"–9/64" Flange	160 lb	100 pc	cULus, ITB
4H24	Hammer-On Flange Clip, Side Mount Spring Steel, 1/8"–1/4" Flange	200 lb	100 pc	CE, 4H, EM, EBC, cULus, ITB
4H58	, 5/16"–1/2" Flange	200 lb	100 pc	
4H912	9/16"–3/4" Flange	200 lb	100 pc	
4H1318	13/16"–1 1/8" Flange	200 lb	50 pc	cULus
Material: Stainless Steel 301 (EN 1.4310)				
4H24SS	S301, 1/8"–1/4" Flange	140 lb	100 pc	–
4H58SS	S301, 5/16"–1/2" Flange	140 lb	100 pc	–
4H912SS	S301, 9/16"–3/4" Flange	140 lb	100 pc	–

# STRUCTURAL ATTACHMENTS

## Beam/Purlin



### nVENT CADDY TRUSS-T BAR JOIST HANGER, BOTTOM CHORD

- Easily installs on the bottom chord of engineered open web bar joists from underneath, limiting overhead work
- Innovative attachment effortlessly slides through the middle slot of open web bar joists and quickly locks into place when put under load
- Installation of the complete, self-contained system can be accomplished with one hand and requires no additional special tools
- The unique design of the nVent CADDY Truss-T hanger does not need to be tightened like a traditional beam clamp, providing greater adjustability and speed during system alignment
- Prefabricated single pipe hanger and multi-pipe/tube trapeze assemblies can be prefabricated on the ground or in the shop, and easily hung by the installer
- Centrally loading the bar joist chord eliminates torsion and/or distortion, adhering to the strict rules established by the Steel Joist Institute (SJI)
- The increased load carrying capacity results in the product being UL listed to support a maximum of 8" Schedule 40 pipe
- Included square washer with integrated threaded nut eliminates the need for loose hardware
- Made in the USA



Material: Steel  
Finish: Pregalvanized  
Static Load Safety Factor: 3.5:1



Part #	Description		
CTH037BC	3/8" Rod	1,200 lb	25 pc
CTH050BC	1/2" Rod	1,200 lb	25 pc



# STRUCTURAL ATTACHMENTS

## Beam/Purlin

### nVENT CADDY TRUSS-T BAR JOIST HANGER, TOP CHORD

- Easily installs on the top chord of engineered open web bar joists from underneath, limiting overhead work
- Innovative attachment effortlessly slides through the middle slot of open web bar joists and quickly locks into place when put under load
- Installation of the complete, self-contained system can be accomplished with one hand and requires no additional special tools
- The unique design of the nVent CADDY Truss-T hanger does not need to be tightened like a traditional beam clamp, providing greater adjustability and speed during system alignment
- Prefabricated single pipe hanger and multi-pipe/tube trapeze assemblies can be prefabricated on the ground or in the shop, and easily hung by the installer
- Concentrically loading the bar joist chord eliminates torsion and/or distortion, adhering to the strict rules established by the Steel Joist Institute (SJI)
- The increased load carrying capacity results in the product being UL listed to support a maximum of 8" Schedule 40 pipe
- Included square washer with integrated threaded nut eliminates the need for loose hardware
- Made in the USA



Material: Steel  
Finish: Pregalvanized  
Static Load Safety Factor: 3.5:1



Part #	Description	F ↓	↓ Cube
CTH037TC	3/8" Rod	1,200 lb	25 pc
CTH050TC	1/2" Rod	1,200 lb	25 pc

## STRUCTURAL ATTACHMENTS

### Beam/Purlin

#### PH MULTI-PURPOSE PURLIN CLAMP

- Attaches to bottom of purlins and beams to support threaded rod



Material: Steel  
Finish: Electrogalvanized



Part #	Description	F1	F2	Box
PH4	1/4" Rod, 1/4" Max Flange	200 lb	160 lb	25 pc
PH6	3/8" Rod, 1/4" Max Flange	200 lb	160 lb	25 pc
PH6FP	3/8" Rod, 1/4" Max Flange	200 lb		25 pc

A jam nut is required for fire protection applications. Refer to Static Load 1 when attaching to C and Z purlins. Refer to Static Load 2 when attaching to a flat flange. Recognizing that torque wrenches are generally not used or available on many job sites, the setscrew should be tightened so it contacts the I-beam and then an additional 1/4 to 1/2 turn added.

#### PHSW MULTI-PURPOSE PURLIN CLAMP WITH SWIVEL

- Attachment to bottom of purlins and beams to support threaded rod
- Swivel feature option for attachment to purlins under sloped roofs



Material: Steel  
Finish: Electrogalvanized



Part #	Description	F1	F2	Box
PHSW4	1/4" Rod, 1/4" Max Flange	200 lb	160 lb	25 pc
PHSW6	3/8" Rod, 1/4" Max Flange	200 lb	160 lb	25 pc
PHSW6FP	3/8" Rod, 1/4" Max Flange	200 lb		25 pc

A jam nut is required for fire protection applications. Refer to Static Load 1 when attaching to C and Z purlins. Refer to Static Load 2 when attaching to a flat flange. Recognizing that torque wrenches are generally not used or available on many job sites, the setscrew should be tightened so it contacts the I-beam and then an additional 1/4 to 1/2 turn added.

# STRUCTURAL ATTACHMENTS

## Beam/Purlin

### 315 MALLEABLE IRON PURLIN CLAMP

- Attaches to lower flange of metal beams or purlins
- Supports 45° flanges up to 2" long, and 90° flanges up to 1-1/2" high
- Conforms with Federal Specification WW-H-171 (Type 23), Manufacturers Standardization Society ANSI®/MSS-SP-58 (Type 23)



Material: Cast Iron



Part #	Description	F ↓	↓
Finish: Electrogalvanized			
3150037EG	3/8" Rod, 1" Max Flange	400 lb	25 pc
Finish: Plain			
3150037PL	3/8" Rod, 1" Max Flange	400 lb	25 pc

Setscrew must be tightened and torqued onto the sloped side of the I-beam. Install in accordance with applicable code. Recognizing that torque wrenches are generally not used or available on many job sites, the setscrew should be tightened so it contacts the I-beam and then an additional 1/4 to 1/2 turn added.

### 122 SERIES Z PURLIN CLIP

- Hammer-on clip compensates for angle of purlin
- Provides a portable hole
- Side mount



Material: Spring Steel  
Finish: nVent CADDY Armour



Part #	Description	F ↓	↓
122	1/4" Hole, 1/16" Max Flange	100 lb	100 pc

# STRUCTURAL ATTACHMENTS

## Beam/Purlin

### 123 SERIES Z PURLIN CLIP

- Hammer-on clip compensates for angle of purlin
- Provides method for attaching conduit and boxes to purlin
- Bottom mount



Material: Spring Steel  
Finish: nVent CADDY Armour



Part #	Description	F ↓	↓
123	1/4" Hole, 0.06"-0.1" Flange	100 lb	100 pc

### AF SERIES Z PURLIN CLIP

- Angle flange clip for wire or chain suspensions from Z purlins
- Installs from floor with VAFT tool and conduit



Material: Spring Steel  
Finish: nVent CADDY Armour



Part #	Description	F ↓	↓
AF14	Z Purlin Clip, 1/4" Hole, 1/16"-1/4" Flange	100 lb	100 pc

# STRUCTURAL ATTACHMENTS

## Beam/Purlin

### VF SERIES C PURLIN CLIP

- Provides an attachment for nVent CADDY Speed Link assemblies, wire, S-hooks, or chain from purlin and bar joist
- Installs from floor with VAFT tool and conduit



Material: Spring Steel  
Finish: nVent CADDY Armour



Part #	Description		
VF14	1/16"–1/4" Flange, 1/4" Hole	160 lb	100 pc

### VAFT INSTALLATION TOOL FOR PURLIN CLIPS

- Installation tool for VF & AF assemblies
- Used to install the AF or VF rod clips from the floor



Material: Steel

Part #	Description	
VAFT	Installation Tool	1 pc
VAFTR	Replacement Parts	1 pc

## STRUCTURAL ATTACHMENTS



### Beam/Purlin

#### 325 STEEL SIDE BEAM ATTACHMENT

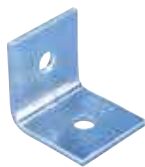
- Fastens to the wall or the side of a joist to support hanger rod
- Conforms with Federal Specification WW-H-171 (Type 35), Manufacturers Standardization Society ANSI®/MSS-SP-58 (Type 34)



Material: Steel

Part #	Description			
Finish: Electrogalvanized				
3250037EG	EG, 7/16" Hole	650 lb	1,150 lb	100 pc
3250050EG	EG, 9/16" Hole	650 lb	1,150 lb	100 pc
Finish: Plain				
3250037PL	7/16" Hole	650 lb	1,150 lb	100 pc
3250050PL	9/16" Hole	650 lb	1,150 lb	100 pc



Refer to Static Load 1 when used with lag screw. Refer to Static Load 2 with bolt to steel. Follow fastener manufacturer's recommended shear and pull-out strength when fastening to the structure. Fastener not included. Install in accordance with applicable code.

#### 327 MALLEABLE IRON SIDE BEAM ATTACHMENT

- Pre-threaded structural attachment fastened to wall or the side of a joist to support hanger rod where two #43 Wood Drive Screws are necessary for proper support



Material: Steel

Part #	Description		
Finish: Electrogalvanized			
3270037EG	EG, 3/8" Rod	250 lb	100 pc
3270050EG	EG, 1/2" Rod	480 lb	100 pc
Finish: Plain			
3270037PL	3/8" Rod	250 lb	100 pc
3270050PL	1/2" Rod	480 lb	100 pc

Load rating dependent on wood structure strength. Follow fastener manufacturer's recommended shear and pull-out strength when fastening to the structure. Fastener not included.

# STRUCTURAL ATTACHMENTS

## Beam/Purlin

### 328 THREADED STEEL SIDE BEAM ATTACHMENT

- Fastens to wall or the side of a joist to support hanger rod
- Pre-threaded
- Conforms with Federal Specification WW-H-171 (Type 35), Manufacturers Standardization Society ANSI®/MSS-SP-58 (Type 34)



Material: Steel

Part #	Description	F1	F2	Box	Cert
Finish: Electrogalvanized					
3280037EG	EG, 3/8" Rod	560 lb	620 lb	100 pc	cULus
Finish: Plain					
3280037PL	3/8" Rod	560 lb	620 lb	100 pc	cULus
3280050PL	1/2" Rod	560 lb	620 lb	100 pc	-

Refer to Static Load 1 when used with lag screw. Refer to Static Load 2 with bolt to steel. Follow fastener manufacturer's recommended shear and pull-out strength when fastening to the structure. Fastener not included. Install in accordance with applicable code.

### 329 SIDE BEAM ATTACHMENT

- Supports pipe from wood, concrete or steel structures
- Installs on vertical mounting surface
- Pre-threaded captive nut allows for easy adjustment
- Eliminates the need for additional hardware
- Complies with VdS® CEA 4001 (Guidelines for Sprinkler Systems) Chapter 15.2.3 and shall be installed in accordance with VdS CEA 4001
- Conforms with Federal Specification WW-H-171 (Type 35), Manufacturers Standardization Society ANSI®/MSS-SP-58 (Type 34)



Material: Steel  
Finish: Electrogalvanized

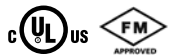

Part #	Description	F	Box
3290037EG	3/8" Rod	350 lb	100 pc

Install in accordance with applicable code.

## STRUCTURAL ATTACHMENTS

### Beam/Purlin

#### 37 STEEL EYE SOCKET ROD HANGER

- Joins hanger rod to a structure



Material: Steel  
Finish: Pregalvanized



Part #	Description	F ↓	☐
0370037EG	3/8" Rod, 3/4"-4" Pipe Size, FM, 3/4"-4" Pipe Size, UL	250 lb	250 pc
0370050EG	1/2" Rod, 2 1/2"-6" Pipe Size, FM, 2 1/2"-8" Pipe Size, UL	760 lb	100 pc

Load rating dependent on wood structure strength. FM® Approved for 1/2" rod size when fastened to concrete and steel only.

#### 38 OFFSET STEEL EYE SOCKET ROD HANGER

- Structural attachment used to join hanger rod to a structure
- Provides full vertical rod adjustment



Material: Steel  
Finish: Electrogalvanized



Part #	Description	F ↓	☐
0380037EG	3/8" Rod	250 lb	250 pc

Load rating dependent on wood structure strength. For 3/8" rod through 2" pipe, use two Model #43 Wood Drive Screws. For 3/8" rod through 4" pipe, use one Model #42 1/2" x 3" Lag Screw.



# STRUCTURAL ATTACHMENTS

## Beam/Purlin

### BC200-CD CONDUIT TO BEAM CLAMP

- Eliminates offset bending conduit
- Threaded hole on back
- Ideal for electrical, mechanical, and HVAC applications



Material: Steel  
Finish: Electrogalvanized



Part #	Description	F ↓	☐
BC200CD0B	1/2" EMT, 1/2" Rigid, 1/2" Max Flange	100 lb	50 pc
BC200CD1B	3/4" EMT, 3/4" Rigid, 1/2" Max Flange	100 lb	50 pc
BC200CD2B	1" EMT, 1" Rigid, 1/2" Max Flange	100 lb	50 pc
BC200CD2.5B	1 1/4" EMT, 1/2" Max Flange	100 lb	50 pc
BC200CD3B	1 1/2" EMT, 1 1/4" Rigid, 1/2" Max Flange	100 lb	50 pc
BC200CD5B	2" EMT, 2" Rigid, 1/2" Max Flange	100 lb	25 pc
BC200CD4B	1 1/2" Rigid, 1/2" Max Flange	100 lb	25 pc

### RA RIGHT ANGLE PIPE AND CONDUIT CLAMP

- Fix pipe or conduit perpendicular to a beam



Material: Cast Iron  
Finish: Hot-Dip Galvanized

Part #	Description	F ↓
RA0037HD	3/8" Rigid, 3/8" Pipe, 3/4" Max Flange	200 lb
RA0050HD	1/2" Rigid, 1/2" Pipe, 3/4" Max Flange	250 lb
RA0075HD	3/4" Rigid, 3/4" Pipe, 3/4" Max Flange	300 lb
RA0100HD	1" Rigid, 1" Pipe, 3/4" Max Flange	400 lb
RA0125HD	1 1/4" Rigid, 1 1/4" Pipe, 3/4" Max Flange	400 lb
RA0150HD	1 1/2" Rigid, 1 1/2" Pipe, 3/4" Max Flange	500 lb
RA0200HD	2" Rigid, 2" Pipe, 3/4" Max Flange	600 lb
RA0250HD	2 1/2" Rigid, 2 1/2" Pipe, 3/4" Max Flange	700 lb
RA0300HD	3" Rigid, 3" Pipe, 3/4" Max Flange	800 lb
RA0250HD	3 1/2" Rigid, 3 1/2" Pipe, 3/4" Max Flange	900 lb
RA0300HD	4" Rigid, 4" Pipe, 3/4" Max Flange	1,000 lb

# STRUCTURAL ATTACHMENTS

## Beam/Purlin

### PAR PARALLEL PIPE AND CONDUIT CLAMP

- Fix pipe or conduit parallel to a beam



Material: Cast Iron

Finish: Hot-Dip Galvanized

Part #	Description	F ↓
PAR0050HD	1/2" Pipe, 3/4" Max Flange	250 lb
PAR0075HD	3/4" Pipe, 3/4" Max Flange	300 lb
PAR0100HD	1" Pipe, 3/4" Max Flange	400 lb
PAR0125HD	1 1/4" Pipe, 3/4" Max Flange	400 lb
PAR0150HD	1 1/2" Pipe, 3/4" Max Flange	500 lb
PAR0200HD	2" Pipe, 3/4" Max Flange	600 lb

# Structural Attachments – Deck



## STRUCTURAL ATTACHMENTS

### Deck

#### TDH TRAPEZOIDAL DECK HANGER

- Easy install
- If thread connection is required, use square nut THHM and snap in
- Use TDHP perforation tool to punch hole in decking



Material: Spring Steel  
Finish: nVent CADDY Armour

Part #	Description		Cert
TDH	Trapezoidal Deck Hanger, , 14 mm Unthreaded Hole	50 pc	ITB

Ceiling Thickness	Static Load
.0248" - .0276"	130 lb
.0277" - .0315"	150 lb
.0316" - .0394"	180 lb
.0395" - .0472"	225 lb

#### TDHT TRAPEZOIDAL DECK HANGER WITH NUT

- Easy install
- Use TDHP perforation tool to punch hole in decking



Material: Spring Steel  
Finish: nVent CADDY Armour

Part #	Description	
TDHT4	1/4" Rod	50 pc
TDHT6	3/8" Rod	50 pc

Ceiling Thickness	Static Load
.0248" - .0276"	130 lb
.0277" - .0315"	150 lb
.0316" - .0394"	180 lb
.0395" - .0472"	225 lb

# STRUCTURAL ATTACHMENTS

## Deck

### TDHP TRAPEZOIDAL DECK HOLE PUNCH

- Includes springs for quick release
- Height adjustable
- Replacement die set available



Material: Steel

Part #	Description	
TDHP2	Trapezoidal Deck Hole Punch	1 pc

### REPLACEMENT DIE FOR TDHP TRAPEZOIDAL DECK HOLE PUNCH

- Includes two punches with springs, nuts and washers



Material: Steel

Part #	Description	
TDHP2PR10	Replacement Die for TDHP Trapezoidal Deck Hole Punch	1 pc



### CELLULAR FLOOR DECK HANGER FOR THREADED ROD

- Positive locking through deck tab
- Prevents twisting or loosening due to vibration



Material: Spring Steel  
Finish: nVent CADDY Armour



Part #	Description		
DH4TI	1/4" Hole, Threaded	160 lb	100 pc
DH6TI	3/8" Hole, Threaded	160 lb	100 pc

Check with deck manufacturer for recommended load capacity.

## STRUCTURAL ATTACHMENTS

### Deck

#### STANDOFF DECK ANGLE BRACKET

- Meets the requirements of NEC® Section 300.4(E)
- Supports conduit or pipe 1-1/2" (38 mm) under the roof decking to prevent potential damage from nails or screws



Material: Steel  
Finish: Plain

Part #	Description	
CPNAM	1 1/2"	100 pc

#### CD-CPNAM CONDUIT/PIPE TO DECK ANGLE BRACKET

- Meets the requirements of NEC® Section 300.4(E)
- Supports conduit or pipe 1-1/2" (38 mm) under the roof decking to prevent potential damage from nails or screws



Material: Steel  
Finish: Electrogalvanized

Part #	Description	
CD0BCPNAM	1/2" EMT, 1/2" Rigid/Pipe	50 pc
CD1BCPNAM	3/4" EMT, 3/4" Rigid/Pipe	50 pc
CD2BCPNAM	1" EMT, 1" Rigid/Pipe	50 pc
CD2.5BCPNAM	1 1/4" EMT	50 pc

#### CD-TDH CONDUIT/PIPE TO DECK HANGER

- Meets the requirements of NEC® Section 300.4(E)
- Supports conduit or pipe 1-1/2" (38 mm) under the roof decking to prevent potential damage from nails or screws



Material: Steel  
Finish: Electrogalvanized

Part #	Description	
CD0BTDH	1/2" EMT, 1/2" Rigid/Pipe	50 pc
CD1BTDH	3/4" EMT, 3/4" Rigid/Pipe	50 pc
CD2BTDH	1" EMT, 1" Rigid/Pipe	50 pc
CD2.5BTDH	1 1/4" EMT	50 pc

# Structural Attachments – Wall/Ceiling



Structural Attachments -  
Wall/Ceiling

# STRUCTURAL ATTACHMENTS

## Wall/Ceiling

### ANGLE BRACKET WITH SHOT-FIRE BRACKET

- Provides an attachment point for nVent CADDY Speed Link assemblies, wire, S-hooks, or chain
- Complete with shot-fire bracket and pre-assembled drive pin from DEWALT®
- Quickly and easily attaches to concrete, steel or composite metal decking
- Integrated pin installs easily using powder-actuated or single-shot gas-actuated tools
- ICC-ES ESR-2024 evaluation report available for drive pin from DEWALT®



Material: Steel

Finish: Electrogalvanized

Part #	Description	F	
ABSF	Angle Bracket with Shot-Fire Bracket	100 lb	100 pc

Uses Powers Fasteners, Inc. part number 50032. Static load was established based on a 1" (25.4 mm) embedment depth and 3,000 psi (20.68 MPa) lightweight concrete. For variations in embedment and material please consult [anchors.dewalt.com](http://anchors.dewalt.com). Pre-assembled drive pin from Powers Fasteners, Inc. works with Powers® C4CZ, Simpson® GCN-MEPKT, SPIT® P1000, P200, P2201, P3500 / PA3500, P35s, P45, P60, P7201, Sniper, Ramset® 721, Cobra, D45 / D60 / D60L, M70, SA270, T3SS, TS750P, TS60P, Viper; Hilti® DX35, DX350 / DX351 / DX36M, DX100 / DX200, DX460, DXA40, DXA41, DXE72 / DX400; Würth® Diva-1, BST-1, BST-2 or equivalent nailers. For shot-fired supports in seismic design category D, E, or F, maximum load is the lesser of 90 lb (400 N) or the published load.



# STRUCTURAL ATTACHMENTS

## Wall/Ceiling

### ANGLE BRACKET WITH NAIL GUN INSERT

- Provides an attachment point for nVent CADDY Speed Link assemblies, wire, S-hooks, or chain
- Complete with concrete nail gun insert bracket
- Clips onto nozzle of gas or battery-actuated nail guns allowing for hands-off installation at structure or from the floor using a pole
- Longer leg angle bracket for tool clearance
- Quickly and easily attaches to concrete, steel or composite metal decking



Material: Steel, Nylon  
Finish: Electrogalvanized



Part #	Description	F ↓	↓ Cube
ABGBSF	Angle Bracket with Nail Gun Insert	100 lb	100 pc

Static Load represents the static load of the nail gun insert assembly. Please consult with the nail manufacturer to evaluate the static load of the nail and type of concrete used for the installation. Maximum load is the lesser of the static load from the nail manufacturer or the published load for the assembly. Nail gun insert is compatible with BeA® CN60-688ES, Hilti® BX 3, GX 3, DEWALT® Trak-It C3, SPIT® PULSA 800E, 700, 1000 or equivalent nailers.

### ANGLE BRACKET

- Provides an attachment for nVent CADDY Speed Link assemblies, wire, threaded rod, S-hooks, or chain from concrete or wood

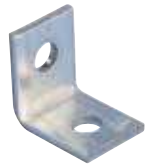

Material: Steel  
Finish: Pregalvanized



Part #	Description	F ↓	↓ Cube
AB	PG, 0.25" Holes	160 lb	100 pc
AB375	PG, 0.25" Hole 1, 0.375" Hole 2	160 lb	100 pc

Structural Attachments -  
Wall/Ceiling

# STRUCTURAL ATTACHMENTS

## Wall/Ceiling

### PIN DRIVEN ANGLE BRACKET

- Longer leg angle bracket for tool clearance
- Designed to fit a variety of pin drivers
- Improved for easier installation with pin drivers
- Preassembly options available for rod, wire, strap and cable applications



Material: Steel  
Finish: Pregalvanized



Part #	Description	F ↓	
AFAB3	3/16" Hole 1	160 lb	50 pc
AFAB4	1/4" Hole 1	350 lb	50 pc
AFAB6	3/8" Hole 1	350 lb	50 pc

Load limits apply to nVent CADDY Fasteners only. Pin must be evaluated separately.

### OFFSET BRACKET

- Permits wire or chain drops from concrete or wood



Material: Steel  
Finish: Pregalvanized



Part #	Description	
AO	1/4" Hole	100 pc

# STRUCTURAL ATTACHMENTS

## Wall/Ceiling

### 365 STEEL WALL OR CEILING PLATE

- Structural attachment to support hanger rod from a ceiling or a wall



Material: Steel

Part #	Description	F ↓	↓ Cube
Finish: Electrogalvanized			
3650037EG	EG, 3/8" Rod	100 lb	250 pc
Finish: Plain			
3650037PL	3/8" Rod	100 lb	250 pc

Follow fastener manufacturer's recommended shear and pull-out strength when fastening to the structure. Fastener not included.

### 365M MALLEABLE IRON WALL OR CEILING PLATE

- Structural attachment to support hanger rod from a ceiling or a wall



Material: Cast Iron

Part #	Description	F ↓	↓ Cube
Finish: Copper Electroplated			
365M0037CP	CP, 3/8" Rod	180 lb	100 pc
365M0050CP	CP, 1/2" Rod	180 lb	100 pc
Finish: Electrogalvanized			
365M0037EG	EG, 3/8" Rod	180 lb	100 pc
365M0050EG	EG, 1/2" Rod	180 lb	100 pc
Finish: Plain			
365M0037PL	3/8" Rod	180 lb	100 pc
365M0050PL	1/2" Rod	180 lb	100 pc

Follow fastener manufacturer's recommended shear and pull-out strength when fastening to the structure. Fastener not included.

## STRUCTURAL ATTACHMENTS



### Wall/Ceiling

#### 352 STANDARD DUTY WELDED WALL BRACKET

- Wall attachment to support or suspend static piping
- Conforms with Federal Specification WW-H-171 (Type 32), Manufacturers Standardization Society ANSI®/MSS-SP-58 (Type 32)



Material: Steel  
Finish: Plain

Part #	Description		
3520100PL	18"	1,500 lb	1 pc
3520200PL	24"	1,500 lb	1 pc
3520300PL	30"	1,500 lb	1 pc

Follow fastener manufacturer's recommended shear and pull-out strength when fastening to the structure. Fastener not included. Install in accordance with applicable code.

# Structural Attachments – Concrete Inserts



Structural Attachments -  
Concrete Inserts

# STRUCTURAL ATTACHMENTS

## Concrete Inserts

### 355 CONCRETE INSERT

- Structural attachment in all grades of concrete
- Knockout keeps interior empty during pour
- Allows for horizontal rod adjustment up to 1-1/4"
- 355N Insert Nut required for UL Listing and FM Approval
- Conforms with Federal Specification WW-H-171 (Type 19), Manufacturers Standardization Society ANSI®/MSS-SP-58 (Type 18)



Material: Steel



Part #	Description	F	
Finish: Electrogalvanized			
3550000EG	EG	1,200 lb	150 pc
Finish: Plain			
3550000PL	Plain	1,200 lb	150 pc

Rod should be threaded through the nut until it tightens against the top of the insert. For installation, place knockout side down on concrete form and nail in place. Wire 12" piece of #4 reinforcing rod on both sides. After concrete pour, knockout can be removed with a screwdriver. cULus® Listed for 3/8" rod size up to 4" pipe and 1/2", 5/8" and 3/4" rod sizes up to 6" pipe. FM® Approved for 3/8", 1/2", 5/8", and 3/4" rod sizes up to 8" pipe. Install in accordance with applicable code.

### 355N INSERT NUT FOR 355 CONCRETE INSERT

- Insert nut for 355 Concrete Insert
- Conforms with Federal Specification WW-H-171 (Type 19), Manufacturers Standardization Society ANSI®/MSS-SP-58 (Type 18)

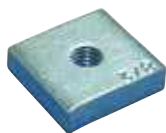

Material: Steel

Part #	Description	F	
Finish: Electrogalvanized			
355N0037EG	EG, 3/8" Rod	600 lb	100 pc
355N0050EG	EG, 1/2" Rod	1,130 lb	100 pc
Finish: Plain			
355N0037PL	3/8" Rod	600 lb	100 pc
355N0050PL	1/2" Rod	1,130 lb	100 pc

Reduced support spacing is required. Install in accordance with applicable code.

# STRUCTURAL ATTACHMENTS



## Concrete Inserts

### 370A SINGLE CONCRETE INSERT PLATE AND ROD

- Used to support hanger rod from metal deck-poured concrete ceiling
- For use when adjustment for concrete thickness is needed



Material: Steel  
Finish: Plain

Part #	Description		
370A0037PL	3/8" Rod	240 lb	50 pc
370A0050PL	1/2" Rod	240 lb	50 pc
370A0062PL	5/8" Rod	600 lb	50 pc

Threaded rod supplied with an Electro Zinc Plated finish. Maximum load ratings are dependent on many factors, which include, but are not limited to: type of concrete, depth of slab, location of anchor in slab, and depth of anchor in slab. Consult a professional engineer regarding anchor positioning.

Structural Attachments -  
Concrete Inserts



Ideal for  
Pre-fab

Structural Attachments -  
Concrete Inserts

## **NVENT CADDY ROD LOCK**

**SEE PAGE 8-1**

The Rod Lock family of products allows contractors to prefabricate complex assemblies at ground level or offsite, and then easily lift and lock them into place by pushing the threaded rod supports into the Rod Lock device. This ingenious technology works with threaded rod with burrs or imperfections, helping to eliminate clean-up time or the need to replace damaged threaded rod.

The most unique feature of the system is its breakthrough “push-to-install” design, which dramatically reduces the installation time of threaded rod support structures when compared to conventional fasteners. Simply speaking – Rod Lock is revolutionizing how contractors support conduit, cable tray, lights, ductwork and pipe by helping to make installations faster, easier and more secure.





# Shields and Saddles



Shields and Saddles

## SHIELDS AND SADDLES

### 119 STRUT MOUNTED INSULATION SHIELD

- Recommended for the suspension of stationary insulated pipe lines
- Flared edges help prevent sharp surfaces from coming into contact with the pipe
- Fits into open side of strut channel



Material: Steel  
Finish: Pregalvanized

Part #	Description	
1190200	2" Shield	130 pc
1190250	2 1/2" Shield	100 pc
1190300	3" Shield	80 pc
1190350	3 1/2" Shield	70 pc
1190400	4" Shield	60 pc
1190500	5" Shield	40 pc
1190600	6" Shield	30 pc

## SHIELDS AND SADDLES

Insulation Shield Sizing Chart for Copper Tubing									
Nominal Iron Pipe Size	Insulation Thickness								
	1/2"	3/4"	1"	1 1/2"	2"	2 1/2"	3"	3 1/2"	4"
1/2"	2"	2"	2 1/2"	3 1/2"	5"	6"	8"	-	-
3/4"	2"	2 1/2"	2 1/2"	3 1/2"	5"	6"	8"	-	-
1"	2"	2 1/2"	3"	4"	5"	6"	8"	-	-
1 1/4"	2 1/2"	3"	3"	5"	5"	6"	8"	-	-
1 1/2"	2 1/2"	3"	3 1/2"	5"	6"	8"	8"	-	-
2"	3"	3 1/2"	4"	5"	6"	8"	8"	10"	-
2 1/2"	3 1/2"	4"	5"	6"	8"	8"	10"	10"	-
3"	4"	5"	5"	8"	8"	10"	10"	10"	12"
3 1/2"	5"	5"	6"	8"	8"	10"	10"	12"	12"
4"	5"	6"	6"	8"	8"	10"	10"	12"	12"
5"	6"	8"	8"	8"	10"	10"	12"	12"	-
6"	8"	8"	8"	10"	10"	12"	12"	-	-
8"	10"	10"	10"	12"	12"	-	-	-	-
10"	12"	12"	12"	-	-	-	-	-	-

Insulation Shield Sizing Chart for Copper Tubing				
Nominal Copper Tube Size	Insulation Thickness			
	1/2"	3/4"	1"	1 1/2"
1/2"	1 1/2"	1 1/2"	2 1/2"	3 1/2"
3/4"	2"	2"	2 1/2"	3 1/2"
7/8"	2"	2 1/2"	3"	3 1/2"
1"	2"	2 1/2"	3"	3 1/2"
1 1/4"	2"	2 1/2"	3"	4"
1 1/2"	2 1/2"	3"	3 1/2"	5"
2"	3"	3 1/2"	4"	5"
2 1/2"	3 1/2"	4"	4"	5"
3"	4"	5"	5"	6"
3 1/2"	5"	5"	6"	6"
4"	5"	5"	8"	8"
5"	6"	6"	8"	8"
6"	8"	8"	10"	10"

## SHIELDS AND SADDLES

### 125 WELDABLE INSULATION SHIELD

- Distributes load of pipe evenly to eliminate or reduce insulation compression, and risk of crushing at the hanger point
- Conforms with Federal Specification WW-H-171 (Type 41), Manufacturers Standardization Society ANSI®/MSS SP58 (Type 40)



Material: Steel  
Finish: Pregalvanized

Part #	Description	
1250150EG	125 Insulation Shield, 1 1/2" Shield	50 pc
1250200EG	125 Insulation Shield, 2" Shield	50 pc
1250250EG	125 Insulation Shield, 2 1/2" Shield	50 pc
1250300EG	125 Insulation Shield, 3" Shield	25 pc
1250350EG	125 Insulation Shield, 3 1/2" Shield	25 pc
1250400EG	125 Insulation Shield, 4" Shield	25 pc
1250500EG	125 Insulation Shield, 5" Shield	25 pc
1250600EG	125 Insulation Shield, 6" Shield	400 pc
1250800EG	125 Insulation Shield, 8" Shield	300 pc
1251000EG	125 Insulation Shield, 10" Shield	140 pc
1251200EG	125 Insulation Shield, 12" Shield	100 pc

Install in accordance with applicable code.

## SHIELDS AND SADDLES

Insulation Shield Sizing Chart for Copper Tubing									
Nominal Iron Pipe Size	Insulation Thickness								
	1/2"	3/4"	1"	1 1/2"	2"	2 1/2"	3"	3 1/2"	4"
1/2"	2"	2"	2 1/2"	3 1/2"	5"	6"	8"	-	-
3/4"	2"	2 1/2"	2 1/2"	3 1/2"	5"	6"	8"	-	-
1"	2"	2 1/2"	3"	4"	5"	6"	8"	-	-
1 1/4"	2 1/2"	3"	3"	5"	5"	6"	8"	-	-
1 1/2"	2 1/2"	3"	3 1/2"	5"	6"	8"	8"	-	-
2"	3"	3 1/2"	4"	5"	6"	8"	8"	10"	-
2 1/2"	3 1/2"	4"	5"	6"	8"	8"	10"	10"	-
3"	4"	5"	5"	8"	8"	10"	10"	10"	12"
3 1/2"	5"	5"	6"	8"	8"	10"	10"	12"	12"
4"	5"	6"	6"	8"	8"	10"	10"	12"	12"
5"	6"	8"	8"	8"	10"	10"	12"	12"	-
6"	8"	8"	8"	10"	10"	12"	12"	-	-
8"	10"	10"	10"	12"	12"	-	-	-	-
10"	12"	12"	12"	-	-	-	-	-	-

Insulation Shield Sizing Chart for Copper Tubing				
Nominal Copper Tube Size	Insulation Thickness			
	1/2"	3/4"	1"	1 1/2"
1/2"	1 1/2"	1 1/2"	2 1/2"	3 1/2"
3/4"	2"	2"	2 1/2"	3 1/2"
7/8"	2"	2 1/2"	3"	3 1/2"
1"	2"	2 1/2"	3"	3 1/2"
1 1/4"	2"	2 1/2"	3"	4"
1 1/2"	2 1/2"	3"	3 1/2"	5"
2"	3"	3 1/2"	4"	5"
2 1/2"	3 1/2"	4"	4"	5"
3"	4"	5"	5"	6"
3 1/2"	5"	5"	6"	6"
4"	5"	5"	8"	8"
5"	6"	6"	8"	8"
6"	8"	8"	10"	10"

## SHIELDS AND SADDLES

### 630 PIPE SADDLE FOR 1" INSULATION

- Designed for high temperature service or where heat losses are to be kept at a minimum and to protect insulation against damage at the point of support
- Conforms with Federal Specification WW-H-171 (Type 40A or 40B), Manufacturers Standardization Society ANSI®/MSS-SP-58 (Type 39)



Material: Steel  
Finish: Plain

Part #	Description	
6300150PL	3/4"-1 1/2" Pipe	1 pc
6300350PL	2"-3 1/2" Pipe	1 pc
6300500PL	4"-5" Pipe	1 pc
6300600PL	6" Pipe	1 pc
6300800PL	8" Pipe	1 pc

Maximum recommended loads are applicable only when the saddle is used on a flat bearing surface and tack welded to the pipe. When a saddle is used with a pipe roll, the maximum load given for the pipe roll applies to the saddle. Install in accordance with applicable code.

Part Number	Pipe Size	Cover Thickness	Size of Pipe Roll for Model #	
			605	610
6300150PL	3/4"	7/8"	2 1/2"	2 1/2"
	1"	1 1/16"	2 1/2"	3"
	1 1/4"	7/8"	2 1/2"	3"
	1 1/2"	1"	3"	3 1/2"
6300350PL	2"	1 1/16"	3 1/2"	4"
	2 1/2"	1 1/16"	3 1/2"	5"
	3"	1"	4"	5"
	3 1/2"	1 1/4"	5"	6"
6300500PL	4"	1 1/16"	5"	6"
	5"	1"	6"	8"
6300600PL	6"	1"	8"	8"
6300800PL	8"	1 1/2"	10"	12"

# SHIELDS AND SADDLES

Center Line of Pipe to Outside of Saddle	Center Line of Pipe to Center Line of Roll for Model #		Static Load F
	605	610	
1 3/4"	2 3/16"	2 1/4"	1,200 lb
1 15/16"	2 7/16"	2 3/8"	1,200 lb
2 1/8"	2 11/16"	2 5/8"	1,200 lb
2 1/4"	2 3/4"	2 3/4"	1,200 lb
2 7/16"	3 1/16"	3 1/16"	1,200 lb
2 3/4"	3 5/16"	3 5/16"	1,200 lb
3 1/16"	3 5/8"	3 5/8"	1,200 lb
3 3/8"	4 1/16"	4 1/16"	1,200 lb
3 7/16"	4 1/8"	4 1/8"	1,800 lb
4 1/16"	4 3/4"	4 3/4"	1,800 lb
4 9/16"	5 3/8"	5 3/8"	1,800 lb
6"	7 1/16"	7 1/16"	1,800 lb

Shields and Saddles

## SHIELDS AND SADDLES

### 631 PIPE SADDLE FOR 1 1/2" INSULATION

- Designed for high temperature service or where heat losses are to be kept at a minimum and to protect insulation against damage at the point of support
- Conforms with Federal Specification WW-H-171 (Type 40A or 40B), Manufacturers Standardization Society ANSI®/MSS-SP-58 (Type 39)



Part Number	Pipe Size	Cover Thickness	Size of Pipe Roll for Model #	
			605	610
6310150PL	3/4"	1 7/16"	3"	3 1/2"
	1"	1 9/16"	3"	4"
	1 1/4"	1 5/8"	3 1/2"	5"
	1 1/2"	1 1/2"	3 1/2"	5"
6310350PL	2"	1 9/16"	4"	5"
	2 1/2"	1 7/16"	5"	6"
	3"	1 9/16"	5"	6"
	3 1/2"	1 13/16"	6"	8"
6310500PL	4"	1 9/16"	6"	8"
	5"	1 1/2"	8"	8"
6310800PL	6"	1 1/2"	8"	10"
	8"	1 1/2"	10"	12"
6311000PL	10"	1 9/16"	12"	14"
6311200PL	12"	1 1/2"	14"	16"
6311400PL	14"	1 1/2"	16"	18"
6311600PL	16"	1 1/2"	18"	20"
6311800PL	18"	1 1/2"	20"	-
6312000PL	20"	1 1/2"	24"	-
6312400PL	24"	1 1/2"	30"	-



## SHIELDS AND SADDLES

Material: Steel  
Finish: Plain

Part #	Description	
6310150PL	1 1/4"-1 1/2" Pipe	1 pc
6310350PL	2"-3 1/2" Pipe	1 pc
6310500PL	4"-5" Pipe	1 pc
6310800PL	6"-8" Pipe	1 pc
6311000PL	10" Pipe	1 pc
6311200PL	12" Pipe	1 pc
6311400PL	14" Pipe	1 pc
6311600PL	16" Pipe	1 pc
6311800PL	18" Pipe	1 pc
6312000PL	20" Pipe	1 pc
6312400PL	24" Pipe	1 pc

Maximum recommended loads are applicable only when the saddle is used on a flat bearing surface and tack welded to the pipe. When a saddle is used with a pipe roll, the maximum load given for the pipe roll applies to the saddle. Install in accordance with applicable code.

Center Line of Pipe to Outside of Saddle	Center Line of Pipe to Center Line of Roll for Model #		Static Load F
	605	610	
2 1/8"	2 11/16"	2 11/16"	1,200 lb
2 7/16"	3"	3"	1,200 lb
2 9/16"	3 1/16"	3 1/16"	1,200 lb
2 11/16"	3 5/16"	3 5/16"	1,200 lb
3"	3 5/8"	3 5/8"	1,200 lb
3 1/4"	3 15/16"	3 15/16"	1,200 lb
3 5/8"	4 5/16"	4 5/16"	1,800 lb
3 7/8"	4 3/4"	4 3/4"	1,800 lb
3 7/8"	4 11/16"	4 11/16"	1,800 lb
4 1/2"	5 5/16"	5 5/16"	1,800 lb
5 3/16"	6"	5 13/16"	1,800 lb
6 5/16"	7 3/8"	7 3/8"	1,800 lb
7 1/4"	8 5/16"	8 1/2"	1,800 lb
8 1/16"	8 1/16"	9 1/2"	5,000 lb
8 7/8"	8 7/8"	10 1/2"	5,000 lb
9 7/8"	11 5/16"	11 5/16"	5,000 lb
10 7/8"	12 3/8"	-	5,000 lb
11 3/4"	13 11/16"	-	7,200 lb
13 5/8"	16 7/16"	-	7,200 lb

## SHIELDS AND SADDLES

### 632 PIPE SADDLE FOR 2" INSULATION

- Designed for high temperature service or where heat losses are to be kept at a minimum and to protect insulation against damage at the point of support
- Conforms with Federal Specification WW-H-171 (Type 40A or 40B), Manufacturers Standardization Society ANSI®/MSS-SP-58 (Type 39)



Part Number	Pipe Size	Cover Thickness	Size of Pipe Roll for Model #	
			605	610
6320150PL	3/4"	1 7/8"	4"	5"
	1"	2 1/8"	4"	5"
	1 1/4"	1 15/16"	4"	5"
	1 1/2"	2 5/16"	5"	5"
6320350PL	2"	2 1/8"	5"	6"
	2 1/2"	2 5/16"	6"	8"
	3"	2 1/16"	6"	8"
	3 1/2"	2 1/4"	6"	8"
6320500PL	4"	2 1/16"	8"	8"
	5"	2"	8"	10"
6320800PL	6"	2"	10"	10"
	8"	2"	10"	12"
6321000PL	10"	2 1/16"	14"	16"
6321200PL	12"	2 1/16"	16"	18"
6321400PL	14"	2"	16"	18"
6321600PL	16"	2"	18"	20"
6321800PL	18"	2"	20"	-
6322000PL	20"	2"	24"	-
6322400PL	24"	2"	30"	-

## SHIELDS AND SADDLES

Material: Steel  
Finish: Plain

Part #	Description	
6320150PL	3/4"-1 1/2" Pipe	1 pc
6320350PL	2"-3 1/2" Pipe	1 pc
6320500PL	4"-5" Pipe	1 pc
6320800PL	6"-8" Pipe	1 pc
6321000PL	10" Pipe	1 pc
6321200PL	12" Pipe	1 pc
6321400PL	14" Pipe	1 pc
6321600PL	16" Pipe	1 pc
6321800PL	18" Pipe	1 pc
6322000PL	20" Pipe	1 pc
6322400PL	24" Pipe	1 pc

Maximum recommended loads are applicable only when the saddle is used on a flat bearing surface and tack welded to the pipe. When a saddle is used with a pipe roll, the maximum load given for the pipe roll applies to the saddle. Install in accordance with applicable code.

Center Line of Pipe to Outside of Saddle	Center Line of Pipe to Center Line of Roll for Model #		Static Load F
	605	610	
2 3/4"	3 3/8"	3 3/8"	1,200 lb
2 15/16"	3 9/16"	3 9/16"	1,200 lb
3 1/8"	3 3/4"	3 3/4"	1,200 lb
3 1/4"	4 1/8"	4 1/8"	1,800 lb
3 1/2"	4 3/16"	4 3/16"	1,800 lb
3 3/4"	4 3/8"	4 1/2"	1,800 lb
4 1/8"	4 13/16"	4 13/16"	1,800 lb
4 3/8"	5 3/16"	5 3/16"	1,800 lb
4 11/16"	5 1/2"	5 1/2"	1,800 lb
4 15/16"	5 3/4"	5 13/16"	1,800 lb
5 11/16"	6 5/8"	6 5/8"	1,800 lb
6 13/16"	7 7/8"	7 7/8"	1,800 lb
7 5/8"	9 1/16"	9"	1,800 lb
8 13/16"	8 3/16"	10 1/4"	5,000 lb
9 1/4"	9 1/4"	10 3/4"	5,000 lb
10 1/4"	11 13/16"	11 13/16"	5,000 lb
11 1/2"	13 1/16"	-	7,200 lb
12 5/16"	14 3/16"	-	7,200 lb
14 3/16"	17 1/16"	-	7,200 lb

## SHIELDS AND SADDLES

### 633 PIPE SADDLE FOR 2 1/2" INSULATION

- Designed for high temperature service or where heat losses are to be kept at a minimum and to protect insulation against damage at the point of support
- Conforms with Federal Specification WW-H-171 (Type 40A or 40B), Manufacturers Standardization Society ANSI®/MSS-SP-58 (Type 39)



Part Number	Pipe Size	Cover Thickness	Size of Pipe Roll for Model #	
			605	610
6330150PL	1 1/4"	2 7/16"	5"	6"
	1 1/2"	2 13/16"	6"	5"
6330200PL	2"	2 5/8"	6"	8"
6330250PL	2 1/2"	2 7/8"	8"	8"
6330300PL	3"	2 9/16"	8"	8"
6330350PL	3 1/2"	2 3/4"	8"	10"
6330500PL	4"	2 9/16"	8"	10"
	5"	2 9/16"	10"	10"
6330800PL	6"	2 1/2"	10"	12"
	8"	2 11/16"	12"	14"
6331000PL	10"	2 9/16"	14"	16"
6331600PL	16"	2 1/2"	20"	-
6331800PL	18"	2 1/2"	24"	-
6332000PL	20"	2 1/2"	24"	-
6332400PL	20"	2 1/2"	30"	-

## SHIELDS AND SADDLES

Material: Steel  
Finish: Plain

Part #	Description	
6330150PL	1 1/4"-1 1/2" Pipe	1 pc
6330200PL	2" Pipe	1 pc
6330250PL	2 1/2" Pipe	1 pc
6330300PL	3" Pipe	1 pc
6330350PL	3 1/2" Pipe	1 pc
6330500PL	4"-5" Pipe	1 pc
6330800PL	6"-8" Pipe	1 pc
6331000PL	10" Pipe	1 pc
6331600PL	16" Pipe	1 pc
6331800PL	18" Pipe	1 pc
6332000PL	20" Pipe	1 pc
6332400PL	24" Pipe	1 pc

Maximum recommended loads are applicable only when the saddle is used on a flat bearing surface and tack welded to the pipe. When a saddle is used with a pipe roll, the maximum load given for the pipe roll applies to the saddle. Install in accordance with applicable code.

Center Line of Pipe to Outside of Saddle	Center Line of Pipe to Center Line of Roll for Model #		Static Load F
	605	610	
3 3/4"	4 3/8"	4 3/8"	1,200 lb
3 13/16"	4 7/16"	4 7/16"	1,800 lb
3 15/16"	4 5/8"	4 11/16"	1,800 lb
4 7/16"	5 5/16"	5 5/16"	1,800 lb
4 11/16"	5 7/16"	5 7/16"	1,800 lb
4 13/16"	5 3/4"	5 3/4"	1,800 lb
5 1/8"	6 1/16"	6 1/16"	1,800 lb
5 9/16"	6 1/2"	6 1/2"	1,800 lb
6 3/16"	7 1/8"	7 13/16"	1,800 lb
7 5/16"	8 3/8"	8 9/16"	1,800 lb
8 3/16"	9 5/8"	9 5/8"	1,800 lb
10 7/8"	12 3/8"	-	7,200 lb
12"	13 15/16"	-	7,200 lb
12 7/8"	14 13/16"	-	7,200 lb
14 3/4"	17 5/8"	-	7,200 lb

## SHIELDS AND SADDLES

### 634 PIPE SADDLE FOR 3" INSULATION

- Designed for high temperature service or where heat losses are to be kept at a minimum and to protect insulation against damage at the point of support
- Conforms with Federal Specification WW-H-171 (Type 40A or 40B), Manufacturers Standardization Society ANSI®/MSS-SP-58 (Type 39)



Part Number	Pipe Size	Cover Thickness	Size of Pipe Roll for Model #	
			605	610
6340200PL	2"	3 1/8"	8"	8"
6340250PL	2 1/2"	3 3/8"	8"	10"
6340300PL	3"	3 1/16"	8"	10"
6340350PL	3 1/2"	3 5/16"	10"	10"
6340500PL	4"	3 1/16"	10"	10"
6340800PL	5"	3 1/16"	10"	12"
	6"	3"	12"	12"
6341000PL	8"	3 1/8"	14"	16"
	10"	3 1/16"	16"	18"
6341200PL	12"	3 1/16"	18"	20"
6341400PL	14"	3"	18"	20"
6341600PL	16"	3"	24"	-
6341800PL	18"	3"	24"	-
6342000PL	20"	3"	24"	-
6342400PL	24"	3"	30"	-

## SHIELDS AND SADDLES

Material: Steel

Finish: Plain

Part #	Description	
6340200PL	2" Pipe	1 pc
6340250PL	2 1/2" Pipe	1 pc
6340300PL	3" Pipe	1 pc
6340350PL	3 1/2" Pipe	1 pc
6340500PL	4"-5" Pipe	1 pc
6340800PL	6"-8" Pipe	1 pc
6341000PL	10" Pipe	1 pc
6341200PL	12" Pipe	1 pc
6341400PL	14" Pipe	1 pc
6341600PL	16" Pipe	1 pc
6341800PL	18" Pipe	1 pc
6342000PL	20" Pipe	1 pc
6342400PL	24" Pipe	1 pc

Maximum recommended loads are applicable only when the saddle is used on a flat bearing surface and tack welded to the pipe. When a saddle is used with a pipe roll, the maximum load given for the pipe roll applies to the saddle. Install in accordance with applicable code.

Center Line of Pipe to Outside of Saddle	Center Line of Pipe to Center Line of Roll for Model #		Static Load F
	605	610	
4 11/16"	5 1/2"	5 1/2"	1,800 lb
4 15/16"	5 11/16"	5 13/16"	1,800 lb
5"	5 15/16"	5 15/16"	1,800 lb
5 1/2"	6 7/16"	6 7/16"	1,800 lb
5 9/16"	6 1/2"	6 1/2"	1,800 lb
6 1/8"	7 1/16"	7 3/16"	1,800 lb
6 9/16"	7 5/8"	7 5/8"	1,800 lb
7 5/8"	8 15/16"	8 15/16"	1,800 lb
8 7/8"	10 5/16"	10 7/8"	1,800 lb
9 11/16"	9 11/16"	11 3/16"	5,000 lb
10 1/4"	10 1/4"	11 11/16"	5,000 lb
11 3/16"	13"	-	7,200 lb
12 5/16"	14 1/4"	-	7,200 lb
13 1/2"	15 7/16"	-	7,200 lb
15 3/8"	18 3/16"	-	7,200 lb

## SHIELDS AND SADDLES

### 635 PIPE SADDLE FOR 4" INSULATION

- Designed for high temperature service or where heat losses are to be kept at a minimum and to protect insulation against damage at the point of support
- Conforms with Federal Specification WW-H-171 (Type 40A or 40B), Manufacturers Standardization Society ANSI®/MSS-SP-58 (Type 39)



Part Number	Pipe Size	Cover Thickness	Size of Pipe Roll for Model #	
			605	610
6350400PL	4"	4 1/16"	10"	12"
6350500PL	5"	4 3/16"	12"	14"
6350800PL	6"	4 1/8"	14"	16"
	8"	4 1/8"	16"	18"
6351000PL	10"	4 1/16"	18"	20"
6351200PL	12"	4 1/8"	20"	-
6351600PL	16"	4"	24"	-
6351800PL	18"	4"	24"	-
6352000PL	20"	4"	30"	-
6352400PL	24"	4"	30"	-



## SHIELDS AND SADDLES

Material: Steel

Finish: Plain

Part #	Description	
6350400PL	4" Pipe	1 pc
6350500PL	5" Pipe	1 pc
6350800PL	6"-8" Pipe	1 pc
6351000PL	10" Pipe	1 pc
6351200PL	12" Pipe	1 pc
6351600PL	16" Pipe	1 pc
6351800PL	18" Pipe	1 pc
6352000PL	20" Pipe	1 pc
6352400PL	24" Pipe	1 pc

Maximum recommended loads are applicable only when the saddle is used on a flat bearing surface and tack welded to the pipe. When a saddle is used with a pipe roll, the maximum load given for the pipe roll applies to the saddle. Install in accordance with applicable code.

Center Line of Pipe to Outside of Saddle	Center Line of Pipe to Center Line of Roll for Model #		Static Load F
	605	610	
6 9/16"	7 11/16"	7 11/16"	1,800 lb
7 3/16"	8 1/4"	8 7/16"	1,800 lb
7 5/8"	9 1/16"	9 1/16"	1,800 lb
8 11/16"	10 1/8"	10 1/8"	1,800 lb
9 11/16"	11 3/16"	11 3/16"	1,800 lb
10 13/16"	13"	-	5,000 lb
12 5/16"	14 1/4"	-	7,200 lb
13 1/2"	15 7/16"	-	7,200 lb
14 3/16"	17 1/16"	-	7,200 lb
16 9/16"	19 3/8"	-	7,200 lb

# Grab some Popcorn and Check Out What's Happening on the nVent CADDY Channel.

Visit the nVent CADDY channel on YouTube® for the latest instructional 'how-to' videos, product testimonials, and new product launches.

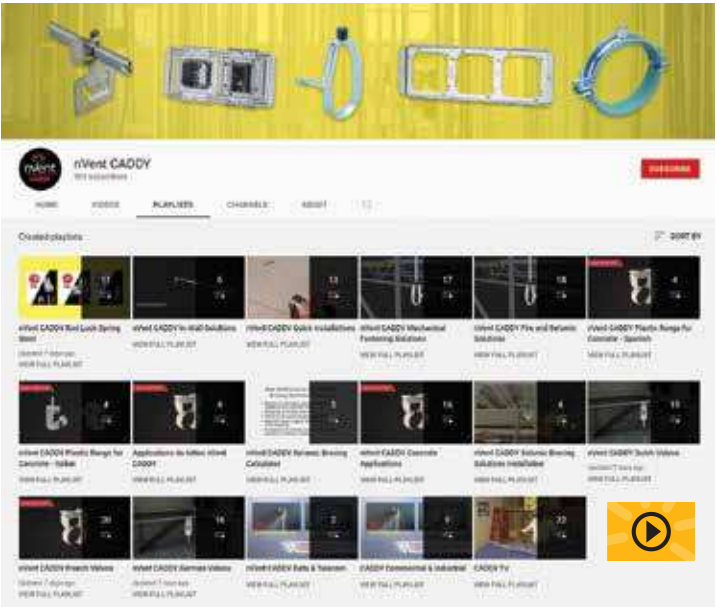

# Rollers and Supports



Rollers and Supports

## ROLLERS AND SUPPORTS

### 605 TWO-ROD ROLLER HANGER

- Suspends pipe from two rods where longitudinal movement in pipe may occur due to expansion or contraction
- Conforms with Federal Specification WW-H-171 (Type 42), Manufacturers Standardization Society ANSI®/MSS-SP-58 (Type 41)



Material: Steel, Cast Iron  
Finish: Hot-Dip Galvanized, ElectroGalvanized

Part #	Description	F ↓
6050600HD	6" Pipe, 3/4" Rod	1,070 lb
6050800HD	8" Pipe, 7/8" Rod	1,350 lb
6051000HD	10" Pipe, 7/8" Rod	1,730 lb
6051200HD	12" Pipe, 7/8" Rod	2,400 lb
6051400HD	14" Pipe, 1" Rod	3,130 lb
6051600HD	16" Pipe, 1" Rod	3,970 lb
6051800HD	18" Pipe, 1" Rod	4,200 lb
6052000HD	20" Pipe, 1 1/4" Rod	4,550 lb
6052400HD	24" Pipe, 1 1/2" Rod	6,160 lb

Roll and sockets are cast iron and axle is carbon steel. Install in accordance with applicable code.

# ROLLERS AND SUPPORTS

## 610 ONE-ROD ROLLER HANGER

- Suspend pipe from a single hanger rod where longitudinal movement may occur in the pipe due to expansion or contraction
- Conforms with Federal Specification WW-H-171 (Type 44), Manufacturers Standardization Society ANSI@/MSS-SP-58 (Type 43)



Material: Steel, Cast Iron  
Finish: Hot-Dip Galvanized, ElectroGalvanized

Part #	Description	F ↓
6100300HD	3" Pipe, 1/2" Rod	310 lb
6100350HD	3 1/2" Pipe, 1/2" Rod	390 lb
6100400HD	4" Pipe, 5/8" Rod	475 lb
6100500HD	5" Pipe, 5/8" Rod	685 lb
6100600HD	6" Pipe, 3/4" Rod	780 lb
6100800HD	8" Pipe, 7/8" Rod	780 lb
6101000HD	10" Pipe, 7/8" Rod	965 lb
6101200HD	12" Pipe, 7/8" Rod	1,200 lb
6101400HD	14" Pipe, 1" Rod	1,200 lb
6101600HD	16" Pipe, 1" Rod	1,200 lb
6101800HD	18" Pipe, 1" Rod	1,400 lb
6102000HD	20" Pipe, 1 1/4" Rod	1,600 lb
6102400HD	24" Pipe, 1 1/4" Rod	1,600 lb

Yoke and axle are carbon steel and roll is cast iron. Install in accordance with applicable code.

## ROLLERS AND SUPPORTS

### ROL12 STRUT MOUNTED ROLLER

- Designed for strut mounting
- For applications where there is longitudinal pipe movement

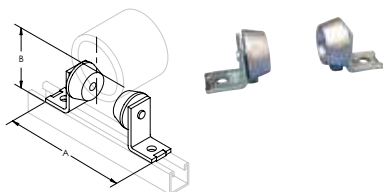

Material: Steel  
Finish: Electrogalvanized

Part #	Description
--------	-------------

ROL12000EG 1"-4" Pipe

Pipe Size	Saddle Number	Covering Thickness	Outer Diameter	Radius	A	B
3/4"	None	0"	11/16"	17/32"	6 1/2"	2 15/16"
	630	7/8"	3 1/4"	1 5/8"	6 1/2"	4 1/8"
	631	1 7/16"	4 3/8"	2 3/16"	8 1/4"	4 7/16"
	632	1 7/8"	5 1/16"	2 17/32"	8 1/4"	4 13/16"
1"	None	0"	15/16"	21/32"	6 1/2"	3 1/8"
	630	11/16"	3 5/8"	1 13/16"	7 1/4"	4 1/4"
	631	1 9/16"	4 5/8"	2 5/16"	8 1/4"	4 9/16"
	632	2 1/8"	5 3/4"	2 7/8"	8 1/4"	5 1/8"
1 1/4"	None	0"	1 11/16"	27/32"	6 1/2"	3 5/16"
	630	7/8"	3 7/8"	1 15/16"	7 1/4"	4 5/16"
	631	1 5/8"	5 1/8"	2 9/16"	8 1/4"	4 13/16"
	632	1 15/16"	6"	3"	8 1/4"	5 1/4"
	633	2 7/16"	6 7/8"	3 7/16"	9 1/4"	5 5/8"
1 1/2"	None	0"	1 7/8"	15/16"	6 1/2"	3 3/8"
	630	1"	4 1/4"	2 1/8"	8 1/4"	4 3/8"
	631	1 1/2"	5 1/4"	2 5/8"	8 1/4"	4 7/8"
	632	2 5/16"	6 7/8"	3 7/16"	9 1/4"	5 9/16"
	633	2 13/16"	7 3/4"	3 7/8"	9 1/4"	6"

## ROLLERS AND SUPPORTS

Pipe Size	Saddle Number	Covering Thickness	Outer Diameter	Radius	A	B
2"	None	0"	2 3/8"	1 3/16"	6 1/2"	3 11/16"
	630	1 1/16"	4 3/4"	2 3/8"	8 1/4"	4 5/8"
	631	1 9/16"	5 3/4"	2 7/8"	8 1/4"	5 1/8"
	632	2 1/8"	7 1/8"	3 9/16"	9 1/4"	5 11/16"
	633	2 5/8"	8 1/8"	4 1/16"	10 1/8"	6 1/16"
	634	3 1/8"	9 1/8"	4 9/16"	10 1/8"	6 5/8"
2 1/2"	None	0"	2 7/8"	1 7/16"	6 1/2"	3 15/16"
	630	1 1/16"	5 3/8"	2 11/16"	8 1/4"	4 15/16"
	631	1 7/16"	6 1/8"	3 1/16"	9 1/4"	5 1/4"
	632	2 5/16"	7 7/8"	3 15/16"	9 1/4"	6 1/8"
	633	2 7/8"	9"	4 1/2"	9 1/4"	6 3/4"
	634	3 3/8"	10"	5"	9 1/4"	7 1/4"
3"	None	0"	3 1/2"	1 3/4"	7 1/4"	4 1/8"
	630	1"	5 7/8"	2 15/16"	8 1/4"	5 1/4"
	631	1 9/16"	7"	3 1/2"	9 1/4"	5 5/8"
	632	2 1/16"	8"	4"	10 1/8"	6 1/16"
	633	2 9/16"	9"	4 1/2"	10 1/8"	6 5/8"
	634	3 1/16"	10"	5"	10 7/8"	7"
3 1/2"	None	0"	4"	2"	7 1/4"	4 3/8"
	630	1 1/4"	6 7/8"	3 7/16"	9 1/4"	5 1/2"
	631	1 13/16"	8"	4"	9 1/4"	6 1/8"
	632	2 1/4"	8 7/8"	4 7/16"	10 1/8"	6 9/16"
	633	2 3/4"	9 7/8"	4 15/16"	10 1/8"	7"
	634	3 5/16"	11"	5 1/2"	10 7/8"	7 7/16"
4"	None	0"	4 1/2"	2 1/4"	8 1/4"	4 1/2"
	630	1 1/16"	7 1/8"	3 9/16"	9 1/4"	5 11/16"
	631	1 9/16"	8 1/8"	4 1/16"	10 1/8"	6 1/16"
	632	2 1/16"	9 1/8"	4 9/16"	10 1/8"	6 5/8"
	633	2 9/16"	10"	5"	10 1/8"	7 1/16"
	634	3 1/16"	11 1/4"	5 5/8"	10 7/8"	7 5/8"
	635	4 1/16"	13"	6 1/2"	10 7/8"	8 9/16"

## ROLLERS AND SUPPORTS

### ROL13 STRUT MOUNTED ROLLER

- Designed for strut mounting
- For applications where there is longitudinal pipe movement

Material: Steel  
Finish: Electrogalvanized

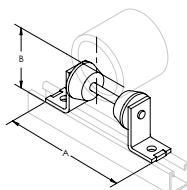

Part #	Description
ROL13034EG	4" Pipe
ROL13046EG	5"-6" Pipe
ROL13068EG	8" Pipe

Pipe Size	Saddle Number	Covering Thickness	Outer Diameter	Radius	A	B
4"	None	0"	4 1/2"	2 1/4"	8 1/4"	4 1/2"
	630	1 1/16"	7 1/8"	3 9/16"	9 1/4"	5 11/16"
	631	1 9/16"	8 1/8"	4 1/16"	10 1/8"	6 1/16"
	632	2 1/16"	9 1/8"	4 9/16"	10 1/8"	6 5/8"
	633	2 9/16"	10"	5"	10 1/8"	7 1/16"
	634	3 1/16"	11 1/4"	5 5/8"	10 7/8"	7 5/8"
	635	4 1/16"	13"	6 1/2"	10 7/8"	8 9/16"
5"	None	0"	5 5/8"	2 13/16"	8 1/4"	5 1/16"
	630	1"	8 1/4"	4 1/8"	10 1/8"	6 1/8"
	631	1 1/2"	9 3/8"	4 11/16"	10 1/8"	6 11/16"
	632	2"	10 3/8"	5 3/16"	10 7/8"	7"
	633	2 9/16"	11 1/4"	5 5/8"	10 7/8"	7 5/8"
	634	3 1/16"	12 3/8"	6 3/16"	10 7/8"	8 1/8"
	635	4 3/16"	14 1/4"	7 1/8"	10 7/8"	9 3/16"
6"	None	0"	6 5/8"	3 5/16"	9 1/4"	5 7/16"
	630	1"	9"	4 1/2"	10 1/8"	6 9/16"
	631	1 1/2"	10 1/8"	5 1/16"	10 7/8"	7"
	632	2"	11"	5 1/2"	10 7/8"	7 1/2"
	633	2 1/2"	12 3/8"	6 3/16"	10 7/8"	8 3/16"
	634	3"	13 1/2"	6 3/4"	10 7/8"	8 5/8"
	635	4 1/8"	15 1/8"	7 9/16"	10 7/8"	9 11/16"
8"	None	0"	8 5/8"	4 5/16"	10 1/8"	6 3/8"
	631	1 1/2"	12"	6"	10 7/8"	8"
	632	2"	13"	6 1/2"	10 7/8"	8 9/16"
	633	2 11/16"	14 1/2"	7 1/4"	10 7/8"	9 5/16"
	634	3 1/8"	15 3/8"	7 11/16"	10 7/8"	9 13/16"
635	4 1/8"	17 3/8"	8 11/16"	10 7/8"	10 7/8"	



# ROLLERS AND SUPPORTS

## ROL14 STRUT MOUNTED ROLLER

- Designed for strut mounting
- For applications where there is longitudinal pipe movement

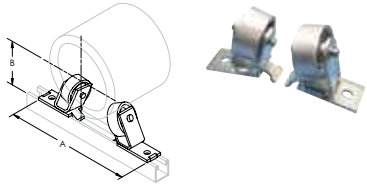

Material: Steel  
Finish: Electrogalvanized

Part #	Description
ROL14000EG	6"-16" Pipe

Pipe Size	Saddle Number	Covering Thickness	Outer Diameter	Radius	A	B
6"	None	0"	6 5/8"	3 5/16"	9 9/16"	6 7/8"
	630	1"	9"	4 1/8"	10 3/16"	7 7/8"
	631	1 1/2"	10"	5"	10 5/8"	8 3/8"
	632	2"	11"	5 1/2"	11"	8 7/8"
	633	2 1/2"	12"	6"	11 3/8"	9 3/8"
	634	3"	13"	6 1/2"	11 3/4"	9 7/8"
8"	635	4 1/8"	15 1/4"	7 5/8"	12 1/2"	10 15/16"
	None	0"	8 5/8"	4 5/16"	10 1/4"	7 13/16"
	631	1 1/2"	12"	6"	11 3/8"	9 3/8"
	632	2"	13"	6 1/2"	11 3/4"	9 7/8"
	633	2 11/16"	14 3/8"	7 3/16"	12 3/16"	10 7/16"
10"	634	3 1/8"	15 1/4"	7 5/8"	12 1/2"	10 15/16"
	635	4 1/8"	17 1/4"	8 5/8"	13 1/4"	11 7/8"
	None	0"	10 3/4"	5 3/8"	11"	8 13/16"
	631	1 1/2"	14 1/4"	7 1/8"	12 1/8"	10 7/16"
	632	2 1/16"	15 1/4"	7 5/8"	12 1/2"	10 15/16"
12"	633	2 9/16"	16 1/4"	8 1/8"	12 13/16"	11 3/8"
	634	3 1/16"	17 1/4"	8 5/8"	13 1/8"	11 7/8"
	635	4 1/16"	19 1/4"	9 3/4"	13 7/8"	12 13/16"
	None	0"	12 3/4"	6 3/8"	11 11/16"	9 3/4"
	631	1 9/16"	16 1/8"	8 1/16"	12 7/8"	11 3/8"
14"	632	2 1/16"	17 1/4"	8 5/8"	13 1/4"	11 7/8"
	633	2 5/8"	18 1/4"	9 1/8"	13 9/16"	12 5/16"
	634	3 1/16"	19 1/4"	9 5/8"	13 7/8"	12 13/16"
	635	4 1/8"	21 3/8"	10 11/16"	14 5/8"	13 3/4"
	None	0"	14"	7"	12 1/16"	10 5/16"
16"	631	1 1/2"	17 1/2"	8 3/4"	13 3/16"	11 7/8"
	632	2"	18 3/8"	9 3/16"	13 9/16"	12 5/16"
	633	2 1/2"	19 3/8"	9 11/16"	13 7/8"	12 13/16"
	634	3"	20-3/8"	10 3/16"	14 1/4"	13 1/4"
	635	4"	22 3/8"	11 3/16"	14 7/8"	14 1/4"
16"	None	0"	16"	8"	12 3/4"	11 5/16"
	631	1 1/2"	19 5/8"	9 13/16"	13 7/8"	12 13/16"
	632	2"	20-3/8"	10 3/16"	14 13/16"	13 1/4"
	633	2 1/2"	21 5/8"	10 13/16"	14 1/2"	13 3/4"
	634	3"	22 1/8"	11 1/16"	14 7/8"	14 1/4"
635	4"	24 3/8"	12 3/16"	15 1/2"	15 1/8"	

# ROLLERS AND SUPPORTS

## ROL15 STRUT MOUNTED ROLLER

- Designed for strut mounting
- For applications where there is longitudinal pipe movement

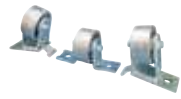
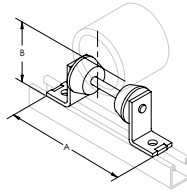

Material: Steel  
Finish: Electrogalvanized

Part #	Description
--------	-------------

ROL15000EG 18"-24" Pipe

Pipe Size	Saddle Number	Covering Thickness	Outer Diameter	Radius	A	B
18"	None	0"	18"	9"	15 1/2"	11 7/8"
	631	1 1/2"	21 3/8"	10 11/16"	16 3/16"	13 7/16"
	632	2"	22 3/8"	11 3/16"	16 3/8"	13 15/16"
	633	2 1/2"	23 3/8"	11 11/16"	16 9/16"	14 7/16"
	634	3"	24 3/8"	12 3/16"	16 3/4"	14 15/16"
	635	4"	26 3/8"	13 3/16"	17 3/16"	15 15/16"
20"	None	0"	20"	10"	16"	12 3/16"
	631	1 1/2"	23 3/8"	11 11/16"	16 9/16"	14 7/16"
	632	2"	24 3/8"	12 3/16"	16 7/8"	14 7/8"
	633	2 1/2"	25 3/8"	12 11/16"	16 15/16"	15 7/16"
	634	3"	26 3/8"	13 3/16"	17 3/16"	15 7/8"
	635	4"	28 3/8"	14 3/16"	17 1/2"	16 15/16"
24"	None	0"	24"	12"	16 13/16"	14 13/16"
	631	1 1/2"	27 1/2"	13 3/4"	17 1/2"	16 3/8"
	632	2"	28 1/2"	14 1/4"	17 1/2"	16 7/8"
	633	2 1/2"	29 1/2"	14 3/4"	17 11/16"	17 3/8"
	634	3"	30-1/2"	15 1/4"	17 7/8"	17 7/8"
	635	4"	32 1/2"	16 1/4"	18 1/8"	18 7/8"
30"	Special Order	0"	30"	15"	17 13/16"	17 13/16"

# ROLLERS AND SUPPORTS

## TELESCOPING PIPE STAND

- Supports and fastens low to the ground horizontal pipe runs
- Complete out-of-the-box assembly provides a compact solution, simplifying material handling and reducing the amount of storage space required
- Designed to minimize fabrication and reduce the installation time of a complete stand by up to 80%
- Telescoping post provides fast vertical height adjustment
- V-bolt fastener accommodates multiple pipe sizes, reducing inventory by over 65%
- Easy “push-to-install” nVent CADDY Rod Lock feature allows the V-bolt to assemble quickly
- Integrated weep hole at bottom of stand provides drainage for condensation
- Includes four holes for anchoring base to floor
- Conforms with Federal Specification WW-H-171 (Type 37, 38), Manufacturers Standardization Society ANSI®/MSS-SP-58 (Type 37)

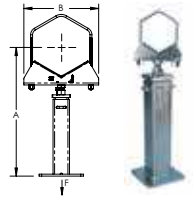

Material: Steel  
 Finish: Electrogalvanized  
 Static Load Safety Factor: 3.5:1



Part #	Description	F
CTS04	1"–8" Pipe	1,370 lb
CTS10	5"–24" Pipe	1,740 lb

When insulating pipe install V-bolt after insulation. Telescoping pipe stand can accommodate pipes up to 24" when v-bolt is removed. Installer must determine weight of the pipe and proper spacing when supporting larger sizes.

Part Number	With V-Bolt	Pipe Size	A	B
CTS04	Yes	1"	20" - 36 1/4"	6 1/2"
		1 1/4"	20 1/4" - 36 1/2"	6 1/2"
		1 1/2"	20 3/8" - 36 5/8"	6 1/2"
		2"	20 5/8" - 36 7/8"	6 1/2"
		3"	21 1/4" - 37 1/2"	6 1/2"
	No	4"	21 7/8" - 38 1/8"	6 1/2"
		5"	22 1/2" - 38 3/4"	6 1/2"
		6"	23 1/8" - 39 1/4"	6 1/2"
		8"	24 1/4" - 40 1/2"	6 1/2"
		CTS10	Yes	5"
6"	23 1/2" - 40"			14 3/8"
8"	24 3/4" - 41"			14 3/8"
10"	26" - 42 1/4"			14 3/8"
No	12"		27 1/4" - 43 3/8"	14 3/8"
	14"		27 7/8" - 44 1/8"	14 3/8"
	16"		29 1/8" - 45 1/4"	14 3/8"
	18"		30 1/4" - 46 3/8"	14 3/8"
	20"		31 3/8" - 47 1/2"	14 3/8"
	24"		33 5/8" - 49 7/8"	14 3/8"

Rollers and Supports



## ARMOUR

### Superior Corrosion Resistance

nVent CADDY Armour provides the highest level of corrosion resistance for steel fasteners on the market today. In fact, nVent is so confident in its performance, we are offering a 10-year limited warranty\* on all parts coated with Armour.

### Excellent Coat Quality

Armour provides an extremely consistent and even coating. This aesthetically pleasing appearance is particularly important for installations in highly visible areas, such as open ceilings.

## INNOVATIVE THREE-LAYER COATING SYSTEM

Innovation is a hallmark of our continuing success. Armour is the latest nVent CADDY innovation in coating technology. Armour is a three-layer coating system that is RoHS compliant.



## ARMOUR

The photography demonstrates product performance after 1,000 hours of salt spray testing.



## "W" – COMPETITOR – "C"

The third layer is a topcoat that provides added barrier protection.

The second layer is a basecoat. It is formulated to self-heal from scratches and sacrifice itself to protect the fastener.

The first layer is a surface preparation of the steel fastener. It is a chemically-bonded layer that improves coating adhesion.

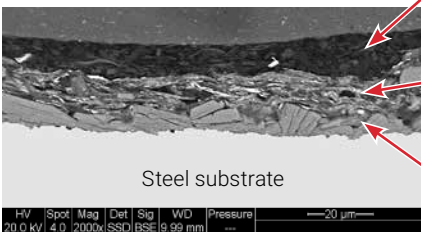

HV	Spot	Mag	Det	Sig	WD	Pressure	
20.0 kV	4.0	2000x	SSD	BSE	9.99 mm	---	20 µm

# In-Wall Fasteners



## IN-WALL FASTENERS

### SNAP-ON NAIL PLATE

- Protects electrical and mechanical installation through studs
- For wood and metal studs
- Press-on installation
- No tools required
- Breakable tabs permit multiple plates to be ganged together
- Holes on legs and surface of plate are provided to secure with nail or screw



Material: Steel  
Finish: nVent CADDY Armour



Part #	Description	
304B2	3 1/8" x 1 1/2"	100 pc

### SMS8 SELF-DRILLING AND TAPPING SCREW

- Suitable for screw gun use
- Thin "wafer-head" type



Material: Steel  
Finish: Electrogalvanized

Part #	Description	
SMS8	#8 Screw, 1/2" Screw	1,000 pc

## IN-WALL FASTENERS

### EASY SNAP GROMMET

- Provides 360° protection for cable, conduit, plumbing and fire sprinkler plumbing in metal studs
- Snap one grommet into standard 1-11/32" field punched hole, or snap two together into any shape factory-punched hole
- Grommet can be split for use on pre-existing installations
- Compliant with UL® 2043 and suitable for use in air handling (plenum) spaces



Material: Polyethylene

Part #	Description	
ESG1	1.315" OD	100 pc
ESG1M	1.315" OD	1,000 pc

### EASY SNAP GROMMET WITH ANTI-RATTLE PROTECTION

- Provides anti-rattle protection
- Snap one grommet into standard 1-11/32" field punched hole, or snap two together into any shape factory-punched hole
- Grommet can be split for use on pre-existing installations
- Compliant with UL® 2043 and suitable for use in air handling (plenum) spaces



Material: Polyethylene

Part #	Description	
ESGP	1" Max Copper Tube, 1/2", 3/4" EMT, 1/2", 3/4" Rigid/Pipe	100 pc

## IN-WALL FASTENERS

### EASY SNAP GROMMET FOR FACTORY PUNCHED HOLES

- Snap grommet into a factory punched hole of any shape
- Provides anti-rattle protection
- Provides 360° protection of conduit, plumbing and fire sprinkler plumbing in metal studs
- Compliant with UL® 2043 and suitable for use in air handling (plenum) spaces

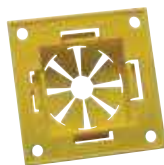

Material: Polyethylene

Part #	Description	
ESGFP	1" Max Copper Tube, 1/2", 3/4", 1" EMT, 1/2", 3/4", 1" Rigid/Pipe	100 pc

### MSP20 METAL STUD PUNCH FOR EASY SNAP GROMMET

- Punches standard sized holes in metal studs
- Easy Snap Grommet snaps easily into punched hole
- Cushioned handles mean less operator fatigue and more comfortable handling
- Tool design with offset handles allows punch to work in confined locations and near perpendicular walls
- Lightweight punch makes accurate location of holes easier
- Hardened steel components keep tool sharp longer – less replacement



Material: Steel

Part #	Description	
MSP20	MSP20 Metal Stud Punch for Easy Snap Grommet	1 pc



# Ceiling/Acoustical

Ceiling/Acoustical



## CEILING/ACOUSTICAL

### LAY-IN AND TROFFER SUPPORT CLIP, STRAIGHT LIP

- Provides a positive method for securing troffers, lay-ins, and air diffusers
- Complies with The National Electrical Code, Article 410.36 Means of Support
- Four clips per fixture required by code



Material: Spring Steel  
Finish: nVent CADDY Armour



Part #	Description	
515	Lay-In and Troffer Support Clip, Straight Lip	100 pc

No load rating, for positioning only.

### LAY-IN AND TROFFER SUPPORT CLIP, STRAIGHT/UPTURNED LIP

- Provides a positive method for securing troffers, lay-ins, and air diffusers
- Four clips per fixture required by code



Material: Spring Steel



Part #	Description	Cert	
Finish: GEOMET® 321			
515A	Lay-In and Troffer Support Clip, Straight/Upturned Lip	UL	100 pc
Finish: Painted — Color: White			
515AWHA	White		100 pc

No load rating, for positioning only.

**SEISMIC LIGHTING FIXTURE CLAMP**

- Secures fluorescent light fixtures to the ceiling frame members
- Requires no additional chains, cables or slack wires attached to the fixture
- Helps strengthen integrity of the T-Grid system
- Holds in place against the force of standard fire-hose pressure
- Meets U.S. building code and electrical code specifications
- Also satisfies NEC® 410.16(C) positive attachment for secure fastening of luminaires (fixtures) complying with Building Code Reference AC184
- Reusable and cost effective

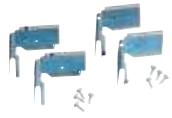

Material: Steel  
 Finish: Plain



Part #	Description	
SFCLT	One Standard Tapered 2' x 4' Fixture	25 x 4 pc
SFCLTCF	One 2' x 2' Fixture	50 x 2 pc
SFCLTCFS	Reinforcement of T-Bar Main Runner/Cross Runner Connections	50 x 2 pc
SFCLTE	Two Standard Tapered 2' x 4' Fixtures End-to-End	25 x 2 pc
SFCLTS	Two Standard Tapered 2' x 4' Fixtures Side-by-Side	25 x 2 pc

Tested for compliance to the UBC, NEC®, NBC, and CEC.

## TELESCOPING CEILING BRACKET

- Supports fans, fixtures and luminaires from ceilings
- Can also be used in stud wall applications to support sconces and electrical boxes
- Allows for infinite positions for box location
- Easy to adjust after the electrical box is installed
- Installs on wood beams or metal studs
- Requires only a screw gun to install



Material: Steel  
Finish: Pregalvanized



Part #	Description	F1	F2	
TCB	Telescoping Ceiling Bracket	35 lb	50 lb	25 pc

Refer to Static Load 1 when used as a fan support. Refer to Static Load 2 when used as a fixture or luminaire support.

# Threaded Rod Hangers



Threaded Rod Hangers

## THREADED ROD HANGERS

### HAMMER-ON FLANGE CLIP, BOTTOM MOUNT

- Can be used to support boxes, fixtures or other applications from beam flanges
- Assorted attachment points provided to reduce inventory
- Requires only a hammer to install



Material: Spring Steel  
Finish: nVent CADDY Armour



Part #	Description	F1	F2	Box
M24	1/8"–1/4" Flange	100 lb	25 lb	100 pc
M58	5/16"–1/2" Flange	100 lb	25 lb	100 pc
M912	9/16"–3/4" Flange	100 lb	25 lb	100 pc
M1318	13/16"–1 1/8" Flange	100 lb	25 lb	50 pc

### HAMMER-ON FLANGE CLIP, BOTTOM MOUNT WITH STUD

- Can be used to support boxes, fixtures or other applications from beam flanges
- Captive threaded stud minimizes the need for additional hardware
- Assorted attachment points provided to reduce inventory
- Requires only a hammer to install



Material: Spring Steel  
Finish: nVent CADDY Armour



Part #	Description	F1	F2	Box
M24S	1/8"–1/4" Flange	100 lb	75 lb	100 pc
M58S	5/16"–1/2" Flange	100 lb	75 lb	100 pc
M912S	9/16"–3/4" Flange	100 lb	75 lb	100 pc
M1318S	13/16"–1 1/8" Flange	100 lb	75 lb	50 pc

# THREADED ROD HANGERS

## HAMMER-ON FLANGE CLIP, BOTTOM MOUNT WITH RETAINER

- Pre-ripped retainer strap is easily bent into position
- Requires only a hammer to install
- 4WN washer wing nut included



Material: Spring Steel  
Finish: nVent CADDY Armour

Part #	Description	F ↓	☐
CM24S	1/8"–1/4" Flange, 8.5" Strap	75 lb	50 pc
CM58S	5/16"–1/2" Flange, 13" Strap	75 lb	50 pc
CM912S	9/16"–3/4" Flange, 13" Strap	75 lb	50 pc

Threaded Rod Hangers

## H-TI/T ROD TO FLANGE CLIP

- Suspends threaded rod from beam flanges
- Threaded rod hanger can swivel to provide a vertical dropdown
- Requires only a hammer to install



Material: Spring Steel  
Finish: nVent CADDY Armour



Part #	Description	F ↓	☐
4TI24	0.25" Hole, Threaded, 0.125"–0.25" Flange	200 lb	100 pc
4TI58	0.25" Hole, Threaded, 0.3125"–0.5" Flange	200 lb	100 pc
4TI912	0.25" Hole, Threaded, 0.5625"–0.75" Flange	200 lb	100 pc
6TA24	0.375" Hole, Plain, 0.125"–0.25" Flange	200 lb	100 pc
6TA58	0.375" Hole, Plain, 0.3125"–0.5" Flange	200 lb	100 pc
6TA912	0.375" Hole, Plain, 0.5625"–0.75" Flange	200 lb	100 pc
6TI24	0.375" Hole, Threaded, 0.125"–0.25" Flange	200 lb	100 pc
6TI58	0.375" Hole, Threaded, 0.3125"–0.5" Flange	200 lb	100 pc
6TI912	0.375" Hole, Threaded, 0.5625"–0.75" Flange	200 lb	100 pc

# THREADED ROD HANGERS

## H-TI/TR ROD TO FLANGE CLIP WITH RETAINER

- Pre-rieveted retainer strap is easily bent into position
- Suspends threaded rod from beam flanges
- Threaded rod hanger can swivel to provide a vertical dropdown
- Requires only a hammer to install



Material: Spring Steel  
Finish: nVent CADDY Armour

Part #	Description	F	☐
C4TI24	1/4" Rod, 1/8"-1/4" Flange	200 lb	50 pc
C4TI58	1/4" Rod, 5/16"-1/2" Flange	200 lb	50 pc
C4TI912	1/4" Rod, 9/16"-3/4" Flange	200 lb	50 pc
C6TI24	3/8" Rod, 1/8"-1/4" Flange	200 lb	50 pc
C6TI58	3/8" Rod, 5/16"-1/2" Flange	200 lb	50 pc
C6TI912	3/8" Rod, 9/16"-3/4" Flange	200 lb	50 pc

Threaded Rod Hangers

## NVENT CADDY ROD LOCK SPRING STEEL ROD HANGER TO FLANGE CLIP

- Suspends threaded rod from beam flanges
- Threaded rod hanger can swivel to provide a vertical dropdown
- Requires only a hammer to install
- Easy "push-to-install" design allows installers to simply push the threaded rod through the mounting hole, instantly holding it in position
- Prefabricated assemblies easily lift and lock into place, helping to save time and money
- Works with slightly damaged threads and minor burrs on threaded rod ends
- Design includes a release mechanism that works with pliers



**Innovative Solution**



Material: Spring Steel  
Finish: nVent CADDY Armour



Part #	Description	F	☐
4QTI24	1/4" Rod, 1/8"-1/4" Flange	75 lb	100 pc
4QTI58	1/4" Rod, 5/16"-1/2" Flange	75 lb	100 pc
4QTI912	1/4" Rod, 9/16"-3/4" Flange	75 lb	100 pc



# THREADED ROD HANGERS

## H-6A ROD TO FLANGE CLIP

- Requires only a hammer to install



Material: Spring Steel  
Finish: nVent CADDY Armour



Part #	Description	F ↓	↓ ↓
6A24	1/8"–1/4" Flange, 3/8" Rod	200 lb	100 pc
6A58	5/16"–1/2" Flange, 3/8" Rod	200 lb	100 pc
6A912	9/16"–3/4" Flange, 3/8" Rod	200 lb	100 pc

Threaded Rod Hangers

## H-708 ROD/WIRE TO FLANGE CLIP

- Requires only a hammer to install



Material: Spring Steel  
Finish: nVent CADDY Armour



Part #	Description	F ↓	↓ ↓
70824	1/8"–1/4" Flange, 1/4" Rod, #8 Wire	200 lb	100 pc
70858	5/16"–1/2" Flange, 1/4" Rod, #8 Wire	200 lb	100 pc
708912	9/16"–3/4" Flange, 1/4" Rod, #8 Wire	200 lb	100 pc

# THREADED ROD HANGERS

## nVENT CADDY ROD LOCK SPRING STEEL ROD HANGER TO BEAM CLAMP

Threaded Rod Hangers

- Suspends threaded rod from beam flanges
- Threaded rod hanger can swivel to provide a vertical dropdown
- Easy “push-to-install” design allows installers to simply push the threaded rod through the mounting hole, instantly holding it in position
- Prefabricated assemblies easily lift and lock into place, helping to save time and money
- Works with slightly damaged threads and minor burrs on threaded rod ends
- Design includes a release mechanism that works with pliers



**Innovative Solution**

Material: Spring Steel  
Finish: nVent CADDY Armour



Part #	Description	F ↓	📦
4QTIBC	1/4" Rod	75 lb	100 pc

## 122-6A ROD TO Z PURLIN CLIP

- Hammer-on clip compensates for angle of purlin
- Provides method for attaching rod to Z purlin



Material: Spring Steel  
Finish: nVent CADDY Armour



Part #	Description	F ↓	📦
1226A	3/8" Rod, 1/16"-1/4" Flange	100 lb	100 pc

Loads indicated are for nVent CADDY Fasteners only.

# THREADED ROD HANGERS

## 122-708 ROD/WIRE TO Z PURLIN CLIP

- Hammer-on clip compensates for angle of purlin
- Provides method for attaching rod to Z purlin



Material: Spring Steel  
Finish: nVent CADDY Armour



Part #	Description	F ↓	☐
122708	1/4" Rod, #8 Wire, 1/16"-1/4" Flange	100 lb	100 pc

Threaded Rod Hangers

## 122-TI/T ROD TO Z PURLIN CLIP

- Hammer-on clip compensates for angle of purlin
- Provides method for attaching rod to purlin



Material: Spring Steel  
Finish: nVent CADDY Armour



Part #	Description	F ↓	☐
1224TI	0.25" Hole, Threaded, 0.0625"-0.25" Flange	100 lb	100 pc
1226T	0.375" Hole, Plain, 0.0625"-0.25" Flange	100 lb	100 pc
1226TI	0.375" Hole, Threaded, 0.0625"-0.25" Flange	100 lb	100 pc

## THREADED ROD HANGERS

### AF-6A ROD TO Z-PURLIN CLIP

- Hammer-on or install from the floor with the VAFT tool
- Supports plain rod from bar joist and Z-Purlin



Material: Spring Steel  
Finish: nVent CADDY Armour



Part #	Description	F ↓	↓ Cube
AF146A	3/8" Rod, 1/16"-1/4" Flange	100 lb	100 pc

### AF-708 ROD/WIRE TO Z PURLIN CLIP

- Hammer-on or install from the floor with the VAFT tool
- Provides an attachment for nVent CADDY Speed Link assemblies, wire, S-hooks, or chain from purlin and bar joist



Material: Spring Steel  
Finish: nVent CADDY Armour



Part #	Description	F ↓	↓ Cube
AF14708	1/4" Rod, #8 Wire, 1/16"-1/4" Flange	100 lb	100 pc

# THREADED ROD HANGERS

## AF-TI/T ROD TO Z PURLIN CLIP

- Used to support 1/4" and 3/8" threaded rod from purlin beam flanges 1/16" thru 1/4" thick
- Hammer-on or install from the floor with the VAFT tool
- Provides method for attaching rod to Z purlin



Material: Spring Steel  
Finish: nVent CADDY Armour



Threaded Rod Hangers

Part #	Description	F ↓	☐
AF144TI	1/4" Hole, Threaded, 1/16"-1/4" Flange	100 lb	100 pc
AF146T	3/8" Hole, Plain, 1/16"-1/4" Flange	100 lb	100 pc
AF146TI	3/8" Hole, Threaded, 1/16"-1/4" Flange	100 lb	100 pc

## VF-6A ROD TO C-PURLIN CLIP

- Hammer-on or install from the floor with the VAFT tool
- Supports plain rod from bar joist and C-Purlin



Material: Spring Steel  
Finish: nVent CADDY Armour



Part #	Description	F ↓	☐
VF146A	3/8" Rod, 1/16"-1/4" Flange	160 lb	100 pc

# THREADED ROD HANGERS

## VF-708 ROD/WIRE TO C PURLIN CLIP

- Supports wire or rod from bar joist and C purlin
- Hammer-on or install from the floor with the VAFT tool



Material: Spring Steel  
Finish: nVent CADDY Armour



Threaded Rod Hangers

Part #	Description	F	Box
VF14708	1/4" Rod, #8 Wire, 1/16"-1/4" Flange	160 lb	100 pc

## VF-TI/T ROD TO C-PURLIN CLIP

- Hammer-on or install from the floor with the VAFT tool
- Provides an attachment for nVent CADDY Speed Link assemblies, wire, S-hooks, or chain from purlin and bar joist



Material: Spring Steel  
Finish: nVent CADDY Armour



Part #	Description	F	Box
VF144TI	1/4" Hole, Threaded, 1/16"-1/4" Flange	160 lb	100 pc
VF146T	3/8" Hole, Plain, 1/16"-1/4" Flange	160 lb	100 pc
VF146TI	3/8" Hole, Threaded, 1/16"-1/4" Flange	160 lb	100 pc

# THREADED ROD HANGERS

## PUSH INSTALL ROD HANGER

- Suspends plain rod from vertical structures such as laminated wood or concrete beams, joists, ceilings and walls



Material: Spring Steel  
Finish: nVent CADDY Armour



Part #	Description	F	
6A	3/8" Rod	↓	100 pc

Threaded Rod Hangers

## PUSH INSTALL ROD HANGER WITH SHOT-FIRE BRACKET

- Suspends plain rod from horizontal structures
- Complete with shot-fire bracket and pre-assembled drive pin from DEWALT®
- Quickly and easily attaches to concrete, steel or composite metal decking
- Integrated pin installs easily using powder-actuated or single-shot gas-actuated tools
- ICC-ES ESR-2024 evaluation report available for drive pin from DEWALT®



Material: Steel, Spring Steel  
Finish: Electrogalvanized, nVent CADDY Armour

Part #	Description	F	
6ASF	3/8" Rod	↓	100 pc

Uses Powers Fasteners, Inc. part number 50032. Static load was established based on a 1" (25.4 mm) embedment depth and 3,000 psi (20.68 MPa) lightweight concrete. For variations in embedment and material please consult [anchors.dewalt.com](https://anchors.dewalt.com). Pre-assembled drive pin from Powers Fasteners, Inc. works with Powers® C4CZ, Simpson® GCN-MEPKT, SPIT® P1000, P200, P2201, P3500 / PA3500, P35s, P45, P60, P7201, Sniper, Ramset® 721, Cobra, D45 / D60 / D60L, M70, SA270, T3SS, TS750P, TS60P, Viper; Hilti® DX35, DX350 / DX351 / DX36M, DX100 / DX200, DX460, DXA40, DXA41, DXE72 / DX400; Würth® Diva-1, BST-1, BST-2 or equivalent nailers. For shot-fired supports in seismic design category D, E, or F, maximum load is the lesser of 90 lb (400 N) or the published load.

## THREADED ROD HANGERS

### PUSH INSTALL ROD HANGER WITH ANGLE BRACKET

- Suspends plain rod from horizontal structures such as laminated wood or concrete beams, joists, ceilings and walls



Material: Spring Steel, Steel  
Finish: nVent CADDY Armour, Pregalvanized



Part #	Description	F ↓	📦
6AB	3/8" Rod, 0.25" Hole	160 lb	100 pc

Loads indicated are for nVent CADDY Fasteners only. Method of attachment to structure must be evaluated separately.

### PUSH INSTALL ROD HANGER WITH OFFSET BRACKET

- Suspends plain rod, threaded rod or wire drops from vertical structures such as laminated wood or concrete beams, joists, ceilings and walls



Material: Steel, Spring Steel  
Finish: Pregalvanized, nVent CADDY Armour



Part #	Description	F ↓	📦
6AO	3/8" Rod	160 lb	100 pc

Loads indicated are for nVent CADDY Fasteners only. Method of attachment to structure must be evaluated separately.



# THREADED ROD HANGERS

## PUSH INSTALL ROD HANGER WITH PIN DRIVEN ANGLE BRACKET

- Longer leg angle bracket for tool clearance
- Designed to fit a variety of pin drivers
- Improved for easier installation with pin drivers



Material: Steel, Spring Steel  
Finish: Pregalvanized, nVent CADDY Armour

Part #	Description	F ↓	☐
6AFAB3	3/8" Rod	160 lb	100 pc

Load limits apply to nVent CADDY Fasteners only. Pin must be evaluated separately.

## PUSH INSTALL ROD/WIRE HANGER

- Permits pre-assembly of wire or plain rod



Material: Spring Steel  
Finish: nVent CADDY Armour



Part #	Description	F ↓	☐
708	1/4" Rod, #8 Wire	160 lb	100 pc

# THREADED ROD HANGERS



## PUSH INSTALL ROD/WIRE HANGER WITH SHOT-FIRE BRACKET

- Permits pre-assembly of wire or plain rod
- Suspends wire or plain rod from horizontal structures
- Complete with shot-fire bracket and pre-assembled drive pin from DEWALT®
- Quickly and easily attaches to concrete, steel or composite metal decking
- Integrated pin installs easily using powder-actuated or single-shot gas-actuated tools
- ICC-ES ESR-2024 evaluation report available for drive pin from DEWALT®



Threaded Rod Hangers

Material: Steel, Spring Steel  
 Finish: Electrogalvanized, nVent CADDY Armour

Part #	Description		
708SF	1/4" Rod	100 lb	100 pc

Uses Powers Fasteners, Inc. part number 50032. Static load was established based on a 1" (25.4 mm) embedment depth and 3,000 psi (20.68 MPa) lightweight concrete. For variations in embedment and material please consult [anchors.dewalt.com](http://anchors.dewalt.com). Pre-assembled drive pin from Powers Fasteners, Inc. works with Powers® C4CZ, Simpson® GCN-MEPKT, SPIT® P1000, P200, P2201, P3500 / PA3500, P35s, P45, P60, P7201, Sniper; Ramset® 721, Cobra, D45 / D60 / D60L, M70, SA270, T3SS, TS750P, TS60P, Viper; Hilti® DX35, DX350 / DX351 / DX36M, DX100 / DX200, DX460, DXA40, DXA41, DXE72 / DX400; Würth® Diva-1, BST-1, BST-2 or equivalent nailers. For shot-fired supports in seismic design category D, E, or F, maximum load is the lesser of 90 lb (400 N) or the published load.

# THREADED ROD HANGERS

## PUSH INSTALL ROD/WIRE HANGER WITH NAIL GUN BRACKET

- Permits pre-assembly of wire or plain rod
- Suspends wire or plain rod from horizontal structures
- Complete with concrete nail gun insert bracket
- Clips onto nozzle of gas or battery-actuated nail guns allowing for hands-off installation at structure or from the floor using a pole
- Longer leg angle bracket for tool clearance
- Quickly and easily attaches to concrete, steel or composite metal decking



Material: Steel, Spring Steel  
Finish: Electrogalvanized, nVent CADDY Armour

Part #	Description	F ↓	📦
708GBSF	1/4" Rod	100 lb	100 pc

Static Load represents the static load of the nail gun insert assembly. Please consult with the nail manufacturer to evaluate the static load of the nail and type of concrete used for the installation. Maximum load is the lesser of the static load from the nail manufacturer or the published load for the assembly. Nail gun insert is compatible with BeA® CN60-688ES, Hilti® BX 3, GX 3, DEWALT® Trak-It C3, SPIT® PULSA 800E, 700, 1000 or equivalent nailers.

## PUSH INSTALL ROD/WIRE HANGER WITH ANGLE BRACKET

- Suspends wire or plain rod from horizontal structures such as laminated wood or concrete beams, joists, ceilings and walls



Material: Steel, Spring Steel  
Finish: Pregalvanized, nVent CADDY Armour



Part #	Description	F ↓	📦
708AB	1/4" Rod, #8 Wire	160 lb	100 pc

Loads indicated are for nVent CADDY Fasteners only. Method of attachment to structure must be evaluated separately.

## THREADED ROD HANGERS

### PUSH INSTALL ROD/WIRE HANGER WITH OFFSET BRACKET

- Suspends plain rod, threaded rod or wire drops from vertical structures such as laminated wood or concrete beams, joists, ceilings and walls



Material: Steel, Spring Steel  
Finish: Pregalvanized, nVent CADDY Armour



Part #	Description	F ↓	
708AO	1/4" Rod, #8 Wire	160 lb	100 pc

Loads indicated are for nVent CADDY Fasteners only. Method of attachment to structure must be evaluated separately.

### PUSH INSTALL ROD/WIRE HANGER WITH PIN DRIVEN ANGLE BRACKET

- Longer leg angle bracket for tool clearance
- Designed to fit a variety of pin drivers
- Improved for easier installation with pin drivers



Material: Steel, Spring Steel  
Finish: Pregalvanized, nVent CADDY Armour

Part #	Description	F ↓	
708AFAB3	1/4" Rod, #8 Wire	160 lb	100 pc

Load limits apply to nVent CADDY Fasteners only. Pin must be evaluated separately.

# THREADED ROD HANGERS

## THREAD INSTALL ROD HANGER

- Supports wire or rod from block or concrete walls



Material: Spring Steel  
Finish: nVent CADDY Armour



Part #	Description	F	⊞
4TI	0.25" Hole 1, Threaded, 0.25" Hole 2	160 lb	100 pc
6T	0.375" Hole 1, Plain, 0.25" Hole 2	160 lb	100 pc
6TI	0.375" Hole 1, Threaded, 0.25" Hole 2	160 lb	100 pc

Threaded Rod Hangers

## THREAD INSTALL ROD HANGER WITH ANGLE BRACKET

- Suspends threaded rod from horizontal structures such as laminated wood or concrete beams, joists, ceilings and walls



Material: Spring Steel, Steel  
Finish: nVent CADDY Armour, Pregalvanized



Part #	Description	F	⊞
4TIB	0.25" Hole 1 Plain, 0.25" Hole 2 Threaded	160 lb	100 pc
6TB	0.25" Hole 1, Plain, 0.375" Hole 2, Plain	160 lb	100 pc
6TIB	0.25" Hole 1, Plain, 0.375" Hole 2, Threaded	160 lb	100 pc

Loads indicated are for nVent CADDY Fasteners only. Method of attachment to structure must be evaluated separately.

# THREADED ROD HANGERS

## THREAD INSTALL ROD HANGER WITH SHOT-FIRE BRACKET

Threaded Rod Hangers

- Suspends threaded rod without the need for additional hardware
- Complete with shot-fire bracket and pre-assembled drive pin from DEWALT®
- Quickly and easily attaches to concrete, steel or composite metal decking
- Integrated pin installs easily using powder-actuated or single-shot gas-actuated tools
- ICC-ES ESR-2024 evaluation report available for drive pin from DEWALT®



Material: Steel, Spring Steel  
 Finish: Electrogalvanized, nVent CADDY Armour

Part #	Description	F	
4TIBSF	EG, CADDY ARMOUR, 1/4" Rod, 2.35" x 2.31"	100 lb	50 pc
6TIBSF	EG, CADDY ARMOUR, 3/8" Rod, 2.35" x 2.31"	100 lb	50 pc

Uses Powers Fasteners, Inc. part number 50032. Static load was established based on a 1" (25.4 mm) embedment depth and 3,000 psi (20.68 MPa) lightweight concrete. For variations in embedment and material please consult anchors.dewalt.com. For shot-fired supports in seismic design category D, E, or F, maximum load is the lesser of 90 lb (400 N) or the published load.

## THREAD INSTALL ROD HANGER WITH NAIL GUN BRACKET

- Suspends threaded rod without the need for additional hardware
- Complete with concrete nail gun insert bracket
- Clips onto nozzle of gas or battery-actuated nail guns allowing for hands-off installation at structure or from the floor using a pole
- Longer leg angle bracket for tool clearance
- Quickly and easily attaches to concrete, steel or composite metal decking



Material: Steel, Spring Steel, Nylon  
 Finish: nVent CADDY Armour, Electrogalvanized

Part #	Description	F	
4TIBGBSF	1/4" Rod	100 lb	50 pc
6TIBGBSF	3/8" Rod	100 lb	50 pc

Static Load represents the static load of the nail gun insert assembly. Please consult with the nail manufacturer to evaluate the static load of the nail and type of concrete used for the installation. Maximum load is the lesser of the static load from the nail manufacturer or the published load for the assembly. Nail gun insert is compatible with BeA® CN60-688ES, Hilti® BX 3, GX 3, DEWALT® Trak-it C3, SPIT® PULSA 800E, 700, 1000 or equivalent nailers.

# THREADED ROD HANGERS

## THREAD INSTALL ROD HANGER WITH OFFSET BRACKET

- Suspends plain rod, threaded rod or wire drops from vertical structures such as laminated wood or concrete beams, joists, ceilings and walls



Material: Steel, Spring Steel  
Finish: nVent CADDY Armour, ElectroGalvanized



Threaded Rod Hangers

Part #	Description	F	Box
4TIO	1/4" Hole, Threaded	160 lb	100 pc
6TIO	3/8" Hole, Threaded	160 lb	100 pc
6TO	3/8" Hole, Plain	160 lb	100 pc

Loads indicated are for nVent CADDY Fasteners only. Method of attachment to structure must be evaluated separately.

## THREAD INSTALL ROD HANGER WITH PIN DRIVEN ANGLE BRACKET

- Longer leg angle bracket for tool clearance
- Designed to fit a variety of pin drivers
- Improved for easier installation with pin drivers



Material: Steel, Spring Steel  
Finish: Pregalvanized, nVent CADDY Armour

Part #	Description	F	Box
4TIAFAB3	1/4" Hole 1, Threaded	160 lb	50 pc
6TAFAB3	3/8" Hole 1, Plain	160 lb	50 pc
6TIAFAB3	3/8" Hole 1, Threaded	160 lb	50 pc

Load limits apply to nVent CADDY Fasteners only. Pin must be evaluated separately.

# THREADED ROD HANGERS

Threaded Rod Hangers

## **nVENT CADDY ROD LOCK SPRING STEEL ROD HANGER**

- Supports rod from block or concrete walls
- Easy "push-to-install" design allows installers to simply push the threaded rod through the mounting hole, instantly holding it in position
- Prefabricated assemblies easily lift and lock into place, helping to save time and money
- Works with slightly damaged threads and minor burrs on threaded rod ends
- Design includes a release mechanism that works with pliers



**Innovative Solution**

Material: Spring Steel  
Finish: nVent CADDY Armour



Part #	Description	F ↓	📦
4QTI	1/4" Rod	75 lb	100 pc

## **nVENT CADDY ROD LOCK SPRING STEEL ROD HANGER WITH ANGLE BRACKET**

- Suspends threaded rod from horizontal structures such as laminated wood or concrete beams, joists, ceilings and walls
- Easy "push-to-install" design allows installers to simply push the threaded rod through the mounting hole, instantly holding it in position
- Prefabricated assemblies easily lift and lock into place, helping to save time and money
- Works with slightly damaged threads and minor burrs on threaded rod ends
- Design includes a release mechanism that works with pliers



**Innovative Solution**

Material: Spring Steel, Steel  
Finish: nVent CADDY Armour, Pregalvanized



Part #	Description	F ↓	📦
4QTIB	1/4" Rod	75 lb	100 pc

Loads indicated are for nVent CADDY Fasteners only. Method of attachment to structure must be evaluated separately.



# THREADED ROD HANGERS

## nVENT CADDY ROD LOCK SPRING STEEL ROD HANGER WITH SHOT-FIRE BRACKET

- Suspends threaded rod without the need for additional hardware
- Complete with shot-fire bracket and pre-assembled drive pin from DEWALT®
- Quickly and easily attaches to concrete, steel or composite metal decking
- Integrated pin installs easily using powder-actuated or single-shot gas-actuated tools
- ICC-ES ESR-2024 evaluation report available for drive pin from DEWALT®
- Easy “push-to-install” design allows installers to simply push the threaded rod through the mounting hole, instantly holding it in position
- Prefabricated assemblies easily lift and lock into place, helping to save time and money
- Works with slightly damaged threads and minor burrs on threaded rod ends
- Design includes a release mechanism that works with pliers



**Innovative Solution**

Threaded Rod Hangers

Material: Spring Steel, Steel  
Finish: nVent CADDY Armour, ElectroGalvanized



Part #	Description		
4QTIBSF	1/4" Rod	75 lb	50 pc

Uses DEWALT® part number DFD3374. Static load was established based on a 1" (25.4 mm) embedment depth and 3,000 psi (20.68 MPa) lightweight concrete. For variations in embedment and material please consult [anchors.dewalt.com](http://anchors.dewalt.com). Pre-assembled drive pin from DEWALT® works with DEWALT® P1000, P2201, P3500/PA3500, P35s, P60, P7201, T1000, Sniper; Hilti® DX2, DX35, DX350/DX351/DX36M, DX400, DX460/DX5, DXA40, DXA41, DXE37, DXE72; Ramset® 721, Cobra, D45, M70, SA270, Viper/Viper4 or equivalent nailers.

# THREADED ROD HANGERS

## nVENT CADDY ROD LOCK SPRING STEEL ROD HANGER WITH NAIL GUN BRACKET

Threaded Rod Hangers

- Suspends threaded rod without the need for additional hardware
- Complete with concrete nail gun insert bracket
- Clips onto nozzle of gas or battery-actuated nail guns allowing for hands-off installation at structure or from the floor using a pole
- Longer leg angle bracket for tool clearance
- Quickly and easily attaches to concrete, steel or composite metal decking
- Easy "push-to-install" design allows installers to simply push the threaded rod through the mounting hole, instantly holding it in position
- Prefabricated assemblies easily lift and lock into place, helping to save time and money
- Works with slightly damaged threads and minor burrs on threaded rod ends
- Design includes a release mechanism that works with pliers



Innovative Solution

Material: Spring Steel, Steel, Nylon  
Finish: nVent CADDY Armour, ElectroGalvanized



Part #	Description	F	
4QTIGBSF	1/4" Rod	75 lb	50 pc

Static Load represents the static load of the nail gun insert assembly. Please consult with the nail manufacturer to evaluate the static load of the nail and type of concrete used for the installation. Maximum load is the lesser of the static load from the nail manufacturer or the published load for the assembly. Nail gun insert is compatible with BeA® CN60-688ES, Hilti® BX 3, GX 3, DEWALT® Trak-It C3, SPIT® PULSA 800E, 700, 1000 or equivalent nailers.

# THREADED ROD HANGERS

## **nVENT CADDY ROD LOCK SPRING STEEL ROD HANGER WITH OFFSET BRACKET**

- Suspends threaded rod from vertical structures such as laminated wood or concrete beams, joists, ceilings and walls
- Easy “push-to-install” design allows installers to simply push the threaded rod through the mounting hole, instantly holding it in position
- Prefabricated assemblies easily lift and lock into place, helping to save time and money
- Works with slightly damaged threads and minor burrs on threaded rod ends
- Design includes a release mechanism that works with pliers





**Innovative  
Solution**

Threaded Rod Hangers

Material: Spring Steel, Steel  
Finish: nVent CADDY Armour, ElectroGalvanized



Part #	Description		
4QT10	1/4" Rod	75 lb	100 pc

Loads indicated are for nVent CADDY Fasteners only. Method of attachment to structure must be evaluated separately.

## THREADED ROD HANGERS

### nVENT CADDY ROD LOCK SPRING STEEL ROD HANGER WITH PIN DRIVEN ANGLE BRACKET

- Longer leg angle bracket for tool clearance
- Designed to fit a variety of pin drivers
- Improved for easier installation with pin drivers
- Quickly and easily attaches to concrete, steel or composite metal decking
- Easy “push-to-install” design allows installers to simply push the threaded rod through the mounting hole, instantly holding it in position
- Prefabricated assemblies easily lift and lock into place, helping to save time and money
- Works with slightly damaged threads and minor burrs on threaded rod ends
- Design includes a release mechanism that works with pliers





**Innovative  
Solution**

Threaded Rod Hangers

Material: Spring Steel, Steel  
Finish: nVent CADDY Armour, Pregalvanized



Part #	Description		
4QTIAFAB3	1/4" Rod	75 lb	100 pc

Load limits apply to nVent CADDY Fasteners only. Pin must be evaluated separately.

# Strap Hangers



Strap Hangers

## STRAP HANGERS

### H-MSR 90° STRAP HANGER WITH FLANGE CLIP

- Supports pipe or duct from flange with banding or strapping
- Pre-measure length of strap, hammer clip on to flange, then trapeze pipe or duct



Material: Steel, Spring Steel  
Finish: nVent CADDY Armour, Pregalvanized

Part #	Description	F	
MSR24	0.125"–0.25" Flange, 1 1/4" Max Strap	200 lb	50 pc
MSR58	0.3125"–0.5" Flange, 1 1/4" Max Strap	200 lb	50 pc
MSR912	0.5625"–0.75" Flange, 1 1/4" Max Strap	200 lb	50 pc

Strap Hangers

### H-MSS INLINE STRAP HANGER WITH FLANGE CLIP

- Supports pipe or duct from flange with banding or strapping



Material: Steel, Spring Steel  
Finish: nVent CADDY Armour, Pregalvanized

Part #	Description	F		Cert
MSS24	0.125"–0.25" Flange, 1 1/4" Max Strap	200 lb	50 pc	ITB
MSS58	0.3125"–0.5" Flange, 1 1/4" Max Strap	200 lb	50 pc	ITB
MSS912	0.5625"–0.75" Flange, 1 1/4" Max Strap	200 lb	50 pc	ITB

# STRAP HANGERS

## STRAP HANGER WITH SHOT-FIRE BRACKET

- Supports pipe or duct with banding or strapping
- Complete with shot-fire bracket and pre-assembled drive pin from DEWALT®
- Quickly and easily attaches to concrete, steel or composite metal decking
- Integrated pin installs easily using powder-actuated or single-shot gas-actuated tools
- ICC-ES ESR-2024 evaluation report available for drive pin from DEWALT®



Material: Steel, Spring Steel  
 Finish: nVent CADDY Armour, Pregalvanized

Part #	Description	F	
MSSSF	1 1/4" Max Strap	100 lb	MSSSF

Uses Powers Fasteners, Inc. part number 50032.

Static load was established based on a 1" (25.4 mm) embedment depth and 3,000 psi (20.68 MPa) lightweight concrete. For variations in embedment and material please consult anchors. dewalt.com.

Pre-assembled drive pin from Powers Fasteners, Inc. works with Powers® C4CZ, Simpson® GCN-MEPKT, SPIT® P1000, P200, P2201, P3500 / PA3500, P35s, P45, P60, P7201, Sniper; Ramset® 721, Cobra, D45 / D60 / D60L, M70, SA270, T3SS, TS750P, TS60P, Viper; Hilti® DX35, DX350 / DX351 / DX36M, DX100 / DX200, DX460, DXA40, DXA41, DXE72 / DX400; Würth® Diva-1, BST-1, BST-2 or equivalent nailers.

For shot-fired supports in seismic design category D, E, or F, maximum load is the lesser of 90 lb (400 N) or the published load.

# nVent CADDY Speed Link Air Duct Bracket Kit



- Ideal for modular assembly – allows attachment of brackets to sections of duct while safely on the ground
- Ready to use out of the box and eliminates the need for cutting and preparing sections of strut
- Prevents the wire rope from damaging the duct
- Angle bracket for installation on to square duct
- Designed to be installed with nVent CADDY Speed Link SLS Locking Devices (both sizes)
- Includes self-tapping sheet metal screws to attach bracket to duct

**SEE PAGE  
20-25**





# nVent CADDY Pyramid



nVent CADDY Pyramid

# NVENT CADDY PYRAMID ROOFTOP SYSTEMS

## nVent CADDY Pyramid ST Strut-Based Supports

### NVENT CADDY PYRAMID ST FIXED STRUT SUPPORT

- Provides superior support for pipe, conduit, duct, cable tray and equipment
- Foam bottom offers low abrasion interface for better roof membrane protection
- Compatible with roof surfaces including single ply, bituminous, metal and spray foam
- Provides superior load distribution, even with varying rooftop surfaces
- Ready to use out of the box, saving installation time and labor
- Multiple sizes and load ratings offer the ability to tailor the solution to the application
- Easy to transport to the roof
- Hot-dip galvanized and UV stabilized for long lasting performance
- Supports green building requirements; thermoplastic bases are made from recycled material and can contribute to earning LEED credits



Material: Polyethylene, Polypropylene, Steel

Finish: Hot-Dip Galvanized

Temperature: -50 to 150 °F

Static Load Safety Factor: 3:1

Part #	Description	F ↓	↓	Cert
PSF6C	6" x 4.8"	300 lb	20 pc	
PSF10C	10" x 4.8"	1,000 lb	10 pc	ITB
PSF10D	10" x 6.4"	1,000 lb	5 pc	ITB
PSF16C	16" x 4.8"	1,500 lb	5 pc	ITB
PSF16D	16" x 6.4"	1,500 lb	5 pc	ITB

Static load at 73.1 kPa (10.6 psi) roof loading. Contact project or roofing engineer for maximum allowable load on individual project roof system.

# NVENT CADDY PYRAMID ROOFTOP SYSTEMS

## nVent CADDY Pyramid ST Strut-Based Supports

### NVENT CADDY PYRAMID ST ADJUSTABLE STRUT SUPPORT

- Height adjustability provides effective navigation of pipe, conduit, duct and cable tray around obstructions
- Foam bottom offers low abrasion interface for better roof membrane protection
- Compatible with roof surfaces including single ply, bituminous, metal and spray foam
- Provides superior load distribution, even with varying rooftop surfaces
- Ready to use out of the box, saving installation time and labor
- Multiple sizes and load ratings offer the ability to tailor the solution to the application
- Hot-dip galvanized and UV stabilized for long lasting performance
- Supports green building requirements; thermoplastic bases are made from recycled material and can contribute to earning LEED credits



Material: Polyethylene, Polypropylene, Steel  
 Finish: Hot-Dip Galvanized  
 Temperature: -50 to 150 °F  
 Static Load Safety Factor: 3:1

Part #	Description	F ↓	☐
PSA10CH13	10" x 6"-13"	1,000 lb	5 pc
PSA16AH18	16" x 7"-18"	1,500 lb	5 pc

nVent CADDY Pyramid

# NVENT CADDY PYRAMID ROOFTOP SYSTEMS

## nVent CADDY Pyramid ST Strut-Based Supports

### NVENT CADDY PYRAMID ST BRIDGE ASSEMBLY

- Ideal for supporting multiple pipe runs, cable tray and air handling units
- Foam bottom offers low abrasion interface for better roof membrane protection
- Compatible with roof surfaces including single ply, bituminous, metal and spray foam
- Provides superior load distribution, even with varying rooftop surfaces
- Ready to use out of the box, saving installation time and labor
- Multiple sizes and load ratings offer the ability to tailor the solution to the application
- Hot-dip galvanized and UV stabilized for long lasting performance
- Supports green building requirements; thermoplastic bases are made from recycled material and can contribute to earning LEED credits



Material: Polyethylene, Polypropylene, Steel  
Finish: Hot-Dip Galvanized  
Temperature: -50 to 150 °F  
Static Load Safety Factor: 3:1

nVent CADDY Pyramid

Part #	Description	F ↓	📦
PSB24A	24"	2,000 lb	2 pc
PSB30A	30"	2,000 lb	2 pc
PSB36A	36"	2,000 lb	2 pc
PSB42A	42"	3,000 lb	2 pc
PSB48A	48"	3,000 lb	2 pc
PSB60A	60"	3,000 lb	2 pc

Static loads are assumed to be uniformly distributed.

# NVENT CADDY PYRAMID ROOFTOP SYSTEMS



## nVent CADDY Pyramid RL Roller-Based Supports

### NVENT CADDY PYRAMID RL FIXED ROLLER SUPPORT

- Roller-based support designed specifically for rooftop applications
- Roller capability allows longitudinal movement of pipe, resulting from thermal expansion or contraction
- Polymeric rollers ensure corrosion free rotation
- Foam bottom offers low abrasion interface for better roof membrane protection
- Compatible with roof surfaces including single ply, bituminous, metal and spray foam
- Ready to use out of the box, saving installation time and labor
- Hot-dip galvanized and UV stabilized for long lasting performance
- Supports green building requirements; thermoplastic bases are made from recycled material and can contribute to earning LEED credits



Material: Polyethylene, Polypropylene, Steel  
 Finish: Hot-Dip Galvanized  
 Temperature: -50 to 150 °F  
 Static Load Safety Factor: 3:1

Part #	Description			Cert
PRF2	2" Max Pipe	100 lb	20 pc	ITB
PRF3	3" Max Pipe	250 lb	5 pc	
PRF6	6" Max Pipe	600 lb	5 pc	ITB

nVent CADDY Pyramid

# NVENT CADDY PYRAMID ROOFTOP SYSTEMS

## nVent CADDY Pyramid RL Roller-Based Supports

### NVENT CADDY PYRAMID RL ADJUSTABLE ROLLER SUPPORT

- Height-adjustable roller-based support designed specifically for rooftop applications
- Height adjustability allows for effective navigation of pipe around obstructions
- Polymeric rollers ensure corrosion free rotation
- Foam bottom offers low abrasion interface for better roof membrane protection
- Compatible with roof surfaces including single ply, bituminous, metal and spray foam
- Ready to use out of the box, saving installation time and labor
- Hot-dip galvanized and UV stabilized for long lasting performance
- Supports green building requirements; thermoplastic bases are made from recycled material and can contribute to earning LEED credits



Material: Polyethylene, Polypropylene, Steel  
Finish: Hot-Dip Galvanized  
Temperature: -50 to 150 °F  
Static Load Safety Factor: 3:1

Part #	Description	F ↓	📦
PRA3H12	3" Max Pipe, 6"-12"	250 lb	5 pc
PRA6H16	6" Max Pipe, 6 1/2"-16"	600 lb	5 pc

nVent CADDY Pyramid

### RETAINER STRAP

- Prevents pipe from being dislodged from roller supports
- Innovative twist-lock design allows for easy installation without requiring hardware removal



Material: Steel  
Finish: Hot-Dip Galvanized

Part #	Description	📦
PRS2	2" Max Pipe	25 pc
PRS3	3" Max Pipe	25 pc
PRS6	6" Max Pipe	25 pc

Retainer straps must be used with roller supports that have an equivalent pipe size.

# NVENT CADDY PYRAMID ROOFTOP SYSTEMS



## nVent CADDY Pyramid H-Frame

### NVENT CADDY PYRAMID H-FRAME POST BASE

- Foam or rubber bottom offers low abrasion interface for better roof membrane protection
- Compatible with roof surfaces including single ply, bituminous, metal and spray foam
- Provides superior load distribution, even with varying rooftop surfaces
- Rubber rooftop interface ideal for solar panel array installations
- Mounting hardware pre-installed in bases
- Hot-dip galvanized and UV stabilized for long lasting performance
- Accepts standard strut channels
- Supports green building requirements; thermoplastic bases are made from recycled material and can contribute to earning LEED credits



Material: Steel, Polypropylene, Polyethylene  
 Finish: Hot-Dip Galvanized  
 Temperature: -30 to 130 °F  
 Static Load Safety Factor: 3:1

Part #	Description		
PHB	Rooftop Pyramid H-Frame Post Base, Foam	750 lb	1 pc
PHBR	Rooftop Pyramid H-Frame Post Base, Rubber	750 lb	1 pc

# NVENT CADDY PYRAMID ROOFTOP SYSTEMS

## nVent CADDY Pyramid H-Frame

### NVENT CADDY PYRAMID H-FRAME KIT

- Foam or rubber bottom offers low abrasion interface for better roof membrane protection
- Compatible with roof surfaces including single ply, bituminous, metal and spray foam
- Provides superior load distribution, even with varying rooftop surfaces
- Rubber rooftop interface ideal for solar panel array installations
- Kit includes 2 post bases with pre-installed mounting hardware, 6 bolts, 6 strut nuts, and 2 L-brackets to complete H-frame
- Hot-dip galvanized and UV stabilized for long lasting performance
- Accepts standard strut channels
- Supports green building requirements; thermoplastic bases are made from recycled material and can contribute to earning LEED credits



Material: Polypropylene, Polyethylene

Temperature: -30 to 130 °F

Static Load Safety Factor: 3:1

Part #	Description	F		Cert
PHK	Rooftop Pyramid H-Frame Kit, Foam	1,500 lb	1 pc	ITB
PHKR	Rooftop Pyramid H-Frame Kit, Rubber	1,500 lb	1 pc	ITB

Static load represents 750 lb (3,335 N) per post base. The end user must select and evaluate the strut framing to ensure the assembled H-frame can properly support the applied load.

### NVENT CADDY PYRAMID H-FRAME HARDWARE KIT

- Kit includes six bolts, six strut nuts, and two L-brackets to build custom multi-tier H-frame assemblies



Material: Steel

Finish: Hot-Dip Galvanized

Part #	Description	
HFRMHDW	nVent CADDY Pyramid H-Frame Hardware Kit	1 pc



# NVENT CADDY PYRAMID ROOFTOP SYSTEMS

## nVent CADDY Pyramid Equipment Supports

### NVENT CADDY PYRAMID EQUIPMENT SUPPORT KIT, 4 POST BASE

- Kit includes post-base assemblies, frame and equipment-support clamps
- Assembles and adjusts to size and height in minutes by one person with one tool
- Innovative crossbar and equipment-support clamps enable quick assembly
- Integral foam pad provides gentle interface for all roof types
- Hot-dip galvanized and UV stabilized for long lasting performance
- Assembled support can be lifted as one unit and easily relocated
- Supports green building requirements; thermoplastic bases are made from recycled material and can contribute to earning LEED credits

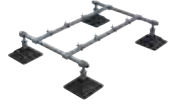

Material: Steel, Polypropylene, Polyethylene  
 Finish: Hot-Dip Galvanized  
 Temperature: -30 to 130 °F  
 Height: 12" – 18"  
 Length: 49 1/2"

Part #	Description	F ↓	📦	Cert
PEK4B	Rooftop Pyramid Equipment Support Kit, 4 Post Base	1,120 lb	1 pc	ITB

Static load must be stable and uniformly distributed across frame.

# NVENT CADDY PYRAMID ROOFTOP SYSTEMS

## nVent CADDY Pyramid Equipment Supports

### NVENT CADDY PYRAMID EQUIPMENT SUPPORT KIT, 6 POST BASE

- Kit includes post-base assemblies, frame and equipment-support clamps
- Assembles and adjusts to size and height in minutes by one person with one tool
- Innovative crossbar and equipment-support clamps enable quick assembly
- Integral foam pad provides gentle interface for all roof types
- Hot-dip galvanized and UV stabilized for long lasting performance
- Assembled support can be lifted as one unit and easily relocated
- Supports green building requirements; thermoplastic bases are made from recycled material and can contribute to earning LEED credits



Material: Steel, Polypropylene, Polyethylene  
Finish: Hot-Dip Galvanized  
Temperature: -30 to 130 °F  
Height: 12" – 18"  
Length: 85 1/2"

Part #	Description	F ↓		Cert
PEK6B	Rooftop Pyramid Equipment Support Kit, 6 Post Base	2,240 lb	1 pc	ITB

Static load must be stable and uniformly distributed across frame.

# NVENT CADDY PYRAMID ROOFTOP SYSTEMS



## nVent CADDY Pyramid Equipment Supports

### NVENT CADDY PYRAMID EQUIPMENT SUPPORT FRAME EXTENSION KIT

- Allows creation of custom equipment support lengths by attaching the nVent CADDY Pyramid Extension Kit in series to a nVent CADDY Pyramid Equipment Support Kit
- Kit includes two post-base assemblies, frame and equipment-support clamps for easy attachment to a nVent CADDY Pyramid Equipment Support Kit
- Square tube and cross bars provide superior load and deflection capabilities over standard strut profiles
- Assembles and adjusts to size and height in minutes by one person with one tool
- Innovative crossbar and equipment-support clamps enable quick assembly
- Integral foam pad provides gentle interface for all roof types
- Hot-dip galvanized and UV stabilized for long lasting performance
- Supports green building requirements; thermoplastic bases are made from recycled material and can contribute to earning LEED credits



Material: Steel, Polypropylene, Polyethylene  
 Finish: Hot-Dip Galvanized  
 Temperature: -30 to 130 °F  
 Height: 12" – 18"  
 Length: 62 1/2"

Part #	Description		
PEKEF	nVent CADDY Pyramid Equipment Support Frame Extension Kit	1,120 lb	1 pc

Static load must be stable and uniformly distributed across frame. nVent CADDY Pyramid Equipment Support Frame Extension must be used in conjunction with a nVent CADDY Pyramid Equipment Support Kit.

nVent CADDY Pyramid

### NVENT CADDY PYRAMID EQUIPMENT SUPPORT POST

- Individual height adjustable leg gives the flexibility to customize the equipment support solution
- Accepts standard strut channels



Material: Steel  
 Finish: Hot-Dip Galvanized

Part #	Description	
RPSC34	nVent CADDY Pyramid Equipment Support Post	2 pc

## NVENT CADDY PYRAMID ROOFTOP SYSTEMS

### nVent CADDY Pyramid Equipment Supports

#### **NVENT CADDY PYRAMID EQUIPMENT SUPPORT SQUARE TUBE**

- Individual square tube gives the flexibility to customize the equipment support solution



Material: Steel  
Finish: Hot-Dip Galvanized

Part #	Description	
RPSC24	42"	2 pc
RPSC25	78"	2 pc

#### **NVENT CADDY PYRAMID EQUIPMENT SUPPORT CROSSBAR**

- Includes innovative support clamps



Material: Steel  
Finish: Hot-Dip Galvanized

Part #	Description	
RPSC28	nVent CADDY Pyramid Equipment Support Crossbar	2 pc

#### **NVENT CADDY PYRAMID EQUIPMENT SUPPORT HEIGHT EXTENSION**

- Increases the height between the equipment support frame and roof deck
- Inserts directly into nVent CADDY Pyramid Equipment Support Bases



Material: Steel  
Finish: Hot-Dip Galvanized

Part #	Description	
PEH31	nVent CADDY Pyramid Equipment Support Height Extension	1 pc

# NVENT CADDY PYRAMID ROOFTOP SYSTEMS

## nVent CADDY Pyramid Equipment Supports

### NVENT CADDY PYRAMID EQUIPMENT SUPPORT POST BASE

- Ideal for use with strut channel type A and U-shaped brackets to create custom equipment supports
- Height adjustable
- Foam bottom offers low abrasion interface for better roof membrane protection
- Compatible with roof surfaces including single ply, bituminous, metal and spray foam
- Provides superior load distribution, even with varying rooftop surfaces
- Hot-dip galvanized and UV stabilized for long lasting performance
- Supports green building requirements; thermoplastic bases are made from recycled material and can contribute to earning LEED credits

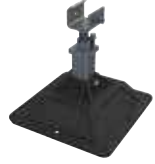

Material: Steel, Polypropylene, Polyethylene  
 Finish: Hot-Dip Galvanized  
 Temperature: -30 to 130 °F  
 Static Load Safety Factor: 3:1

Part #	Description	F	Box
PEB	nVent CADDY Pyramid Equipment Support Post Base	750 lb	2 pc

The end user must select and evaluate the strut framing to ensure the custom assembled equipment support can properly support the applied load.

### NVENT CADDY PYRAMID EQUIPMENT SUPPORT CLAMP

- Ideal for use with strut channel type A and square tube to create custom equipment supports
- Slotted design offers fast and easy installation



Material: Steel  
 Finish: Hot-Dip Galvanized

Part #	Description	Box
PEC	nVent CADDY Pyramid Equipment Support Clamp	20 pc

nVent CADDY Pyramid

# NVENT CADDY PYRAMID ROOFTOP SYSTEMS

## nVent CADDY Pyramid Crossovers and Walkways

### NVENT CADDY PYRAMID CROSSOVER LADDER, 50°

- Standard angle ladders provide easy changes in elevation
- Interchangeable components are easily assembled yielding labor-saving and quick installations
- nVent CADDY Pyramid bases provide superior load distribution and roof membrane compatibility
- Foam bottom offers low abrasion interface for better roof membrane protection
- Aluminum construction designed to withstand harsh environments
- Walking surfaces with serrated tread provides maximum slip resistance and drainage
- Compliant with OSHA, Cal/OSHA and ANSI® standards



Material: Aluminum, Polypropylene, Polyethylene

Part #	Description	F ↓	☐
PCL50S2	20° Walkway Height, 2 Steps	500 lb	1 pc
PCL50S3	30° Walkway Height, 3 Steps	500 lb	1 pc
PCL50S4	40° Walkway Height, 4 Steps	500 lb	1 pc
PCL50S5	50° Walkway Height, 5 Steps	500 lb	1 pc
PCL50S6	60° Walkway Height, 6 Steps	500 lb	1 pc

Clearance of walkway is 3" less than the walkway height.

# NVENT CADDY PYRAMID ROOFTOP SYSTEMS

## nVent CADDY Pyramid Crossovers and Walkways

### NVENT CADDY PYRAMID CROSSOVER LADDER, 90°

- Vertical ladders ideal for tight spaces
- Interchangeable components are easily assembled yielding labor-saving and quick installations
- nVent CADDY Pyramid bases provide superior load distribution and roof membrane compatibility
- Foam bottom offers low abrasion interface for better roof membrane protection
- Aluminum construction designed to withstand harsh environments
- Walking surfaces with serrated tread provides maximum slip resistance and drainage
- Compliant with OSHA, Cal/OSHA and ANSI® standards



Material: Aluminum, Polypropylene, Polyethylene

Part #	Description	F ↓	☐
PCL90S2	20" Walkway Height, 2 Steps	500 lb	1 pc
PCL90S3	30" Walkway Height, 3 Steps	500 lb	1 pc
PCL90S4	40" Walkway Height, 4 Steps	500 lb	1 pc
PCL90S5	50" Walkway Height, 4 Steps	500 lb	1 pc
PCL90S6	60" Walkway Height, 5 Steps	500 lb	1 pc

Clearance of walkway is 3" less than the walkway height.

# NVENT CADDY PYRAMID ROOFTOP SYSTEMS

## nVent CADDY Pyramid Crossovers and Walkways

### NVENT CADDY PYRAMID CROSSOVER SUPPORT TOWER

- Additional support towers ideal for supporting long walkways at varying heights
- Interchangeable components are easily assembled yielding labor-saving and quick installations
- nVent CADDY Pyramid bases provide superior load distribution and roof membrane compatibility
- Foam bottom offers low abrasion interface for better roof membrane protection
- Aluminum construction designed to withstand harsh environments
- Walking surfaces with serrated tread provides maximum slip resistance and drainage
- Compliant with OSHA, Cal/OSHA and ANSI® standards



Material: Aluminum, Polypropylene, Polyethylene

Part #	Description	F ↓	☐
PCT20	20" Walkway Height	500 lb	1 pc
PCT30	30" Walkway Height	500 lb	1 pc
PCT40	40" Walkway Height	500 lb	1 pc
PCT50	50" Walkway Height	500 lb	1 pc
PCT60	60" Walkway Height	500 lb	1 pc

Walkway height represents the height of the walkway when a nVent CADDY Pyramid Crossover Bridge is attached to the support tower. Clearance of walkway is 3" less than the walkway height.



# NVENT CADDY PYRAMID ROOFTOP SYSTEMS

## nVent CADDY Pyramid Crossovers and Walkways

### NVENT CADDY PYRAMID CROSSOVER BRIDGE

- Standard bridge spans that can be combined to create custom pathway lengths
- Interchangeable components are easily assembled yielding labor-saving and quick installations
- Aluminum construction designed to withstand harsh environments
- Walking surfaces with serrated tread provides maximum slip resistance and drainage
- Compliant with OSHA, Cal/OSHA and ANSI® standards



Material: Aluminum

Part #	Description	F ↓	☐
PCB36X12	12"	500 lb	1 pc
PCB36	40"	500 lb	1 pc

Bridge spans require support on each end. Bridge spans exceeding 90" require an additional support tower.

### NVENT CADDY PYRAMID CROSSOVER BRIDGE TURN KIT

- Turn bridges allow for configurations beyond a straight pathway, "L", "U" or "Z" pathways can be created by using turn bridges
- Interchangeable components are easily assembled yielding labor-saving and quick installations
- nVent CADDY Pyramid bases provide superior load distribution and roof membrane compatibility
- Foam bottom offers low abrasion interface for better roof membrane protection
- Aluminum construction designed to withstand harsh environments
- Walking surfaces with serrated tread provides maximum slip resistance and drainage
- Compliant with OSHA, Cal/OSHA and ANSI® standards



nVent CADDY Pyramid

Material: Aluminum, Polypropylene, Polyethylene

Part #	Description	F ↓	☐
PCB36H20	20" Walkway Height	500 lb	1 pc
PCB36H30	30" Walkway Height	500 lb	1 pc
PCB36H40	40" Walkway Height	500 lb	1 pc
PCB36H50	50" Walkway Height	500 lb	1 pc
PCB36H60	60" Walkway Height	500 lb	1 pc

Clearance of walkway is 3" less than the walkway height.

# NVENT CADDY PYRAMID ROOFTOP SYSTEMS

## nVent CADDY Pyramid Crossovers and Walkways

### NVENT CADDY PYRAMID CROSSOVER GUARDRAIL KIT

- Use an extra guardrail kit to block off the end of a pathway or create custom pathway configurations while ensuring all safety criteria are met
- Interchangeable standard components for flexibility while providing safe access over piping, duct, equipment or other utilities on a roof surface
- Aluminum construction designed to withstand harsh environments
- Compliant with OSHA, Cal/OSHA and ANSI® standards



Material: Aluminum

Part #	Description	
PCGK	nVent CADDY Pyramid Crossover Guardrail Kit	1 pc

### NVENT CADDY PYRAMID CROSSOVER PLATFORM

- Height adjustable interlocking platforms allow for quick and easy installation of a custom pathway across rooftop surfaces
- Protect roof surfaces by providing a clearly defined pathway
- Modular design allows for easily configurable heights and lengths to address varying applications
- nVent CADDY Pyramid bases provide superior load distribution and roof membrane compatibility
- Foam bottom offers low abrasion interface for better roof membrane protection
- Aluminum construction designed to withstand harsh environments
- Walking surfaces with serrated tread provides maximum slip resistance and drainage

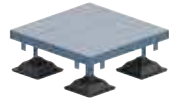

nVent CADDY Pyramid

Material: Aluminum, Polypropylene, Polyethylene

Part #	Description	F	
PCP36	nVent CADDY Pyramid Crossover Platform	500 lb	1 pc

# NVENT CADDY PYRAMID ROOFTOP SYSTEMS



## nVent CADDY Pyramid 50 Foam-Based Support

### NVENT CADDY PYRAMID 50 FOAM-BASED SUPPORT

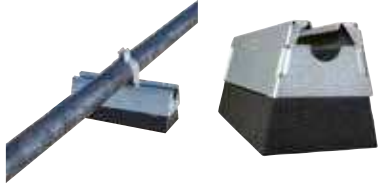
- Replaces slow and labor-intensive installation methods
- Supports pipe, conduit, cable tray and equipment on roofs and below raised floors
- Easily increase load capacity by combining similar nVent CADDY Pyramid supports
- Protects the roof membrane while absorbing shock and vibration, without absorbing water
- Metal cover protects against weather and other environmental conditions, such as bird damage



Material: Steel, Polyethylene  
Static Load Safety Factor: 3:1

Part #	Description		
Finish: Electrogalvanized			
RPS50H4EG	Rooftop Pyramid 50 Foam-Based Support, EG, 4"	50 lb	10 pc
RPS50H6EG	Rooftop Pyramid 50 Foam-Based Support, EG, 6"	50 lb	10 pc
Finish: Hot-Dip Galvanized			
RPS50H6HD	HD, 6"	50 lb	10 pc

# NVENT CADDY PYRAMID ROOFTOP SYSTEMS

## nVent CADDY Pyramid Rooftop Anchor System

### NVENT CADDY PYRAMID ROOFTOP ANCHOR

- Anchors require minimal roof membrane penetration
- System preserves membrane manufacturers' warranty
- Matching membrane material allows for consistent performance and aesthetic
- Installation creates a watertight seal, eliminating water intrusion and damage to the structure



Part #	Description	
Material: EPDM-SBR Rubber		
CRAU24EB1C	EPDM-SBR, CARLISLE Membrane, 11 3/4"	10 pc
CRAU24EB1CR2	EPDM-SBR, CARLISLE Membrane, 11 3/4"	2 pc
Material: Modified Asphalt		
CRAU26ST2F	FIRESTONE Membrane, 18"	10 pc
CRAU26ST2FR2	FIRESTONE Membrane, 18"	2 pc
CRAU26STCR2F	FIRESTONE Membrane, 18"	10 pc
CRAU26STCR2FR2	FIRESTONE Membrane, 18"	2 pc
CRAU26SW12C	CERTAINTeed Membrane, 18"	10 pc
CRAU26SW12CR2	CERTAINTeed Membrane, 18"	2 pc
Material: Polyvinylchloride		
CRAU24PW3J	JOHNS MANVILLE Membrane, 11 3/4"	10 pc
CRAU24PW3JR2	JOHNS MANVILLE Membrane, 11 3/4"	2 pc
CRAU24PW8S	SIKA SARNAFIL Membrane, 11 3/4"	10 pc
CRAU24PW8SR2	SIKA SARNAFIL Membrane, 11 3/4"	2 pc
Material: Thermoplastic Polyolefin (TPO)		
CRAU24TW1C	CARLISLE Membrane, 11 3/4"	10 pc
CRAU24TW1CR2	CARLISLE Membrane, 11 3/4"	2 pc
CRAU24TW2F	FIRESTONE Membrane, 11 3/4"	10 pc
CRAU24TW2FR2	FIRESTONE Membrane, 11 3/4"	2 pc
CRAU24TW3J	JOHNS MANVILLE Membrane, 11 3/4"	10 pc
CRAU24TW3JR2	JOHNS MANVILLE Membrane, 11 3/4"	2 pc
CRAU24TW4G	GAF Membrane, 11 3/4"	10 pc
CRAU24TW4GR2	GAF Membrane, 11 3/4"	2 pc

Anchor system must be installed by a certified roofing contractor according to membrane manufacturer's guidelines to preserve membrane warranty.

# NVENT CADDY PYRAMID ROOFTOP SYSTEMS

## nVent CADDY Pyramid Rooftop Anchor System

### NVENT CADDY PYRAMID ROOFTOP ANCHOR CABLE BRACING

- Stainless steel components of cable assembly provides superior corrosion performance
- Multiple length configurations provide flexibility for various installations
- Pre-assembled cable terminations enable easy installation



Material: Stainless Steel 316 (EN 1.4401)



Part #	Description	
CRA36SS38L2	6.6'	10 pc
CRA36SS38L3	9.8'	10 pc
CRA36SS38L4	13.1'	10 pc

### DECK SCREW

- Secures nVent CADDY Pyramid Rooftop Anchors to various roof substrate materials



Material: Steel  
Finish: Epoxy Coated  
Color: Black

Part #	Description		Part #	Description	
A927W001P100	#14, 2" Screw	100 pc	A927W011P100	#15, 5" Screw	100 pc
A927W002P100	#14, 3" Screw	100 pc	A927W012P100	#15, 6" Screw	100 pc
A927W003P100	#14, 4" Screw	100 pc	A927W013P100	#15, 7" Screw	100 pc
A927W004P100	#14, 5" Screw	100 pc	A927W014P100	#15, 8" Screw	100 pc
A927W005P100	#14, 6" Screw	100 pc	A927W016P100	#14, 10" Screw	100 pc
A927W006P100	#14, 7" Screw	100 pc	A927W018P100	#14, 12" Screw	100 pc
A927W007P100	#14, 8" Screw	100 pc	A927W019P100	#15, 9" Screw	100 pc
A927W008P100	#15, 2" Screw	100 pc	A927W020P100	#15, 10" Screw	100 pc
A927W009P100	#15, 3" Screw	100 pc	A927W021P100	#15, 12" Screw	100 pc
A927W010P100	#15, 4" Screw	100 pc	A927W022P100	#15, 14" Screw	100 pc

#14 deck screws are for general purpose use.  
#15 deck screws are specially suited for OSB and light gauge steel.

# NVENT CADDY PYRAMID ROOFTOP SYSTEMS

## nVent CADDY Pyramid Rooftop Anchor System

### WIRE ROPE CUTTER

- Designed to reduce cable fraying



Material: Steel

Part #	Description	
CSBC48	#36 Brace, 1/4" Max Cable Diameter	1 pc

For brace sizes #12 and #18 use SLWC Wire Rope Cutter.

### MULTI-SIZE MANUAL SWAGING TOOL



Material: Steel

Part #	Description	
CSB3346SB	#12, #18, #36 Brace	1 pc

# NVENT CADDY PYRAMID ROOFTOP SYSTEMS



## nVent CADDY Pyramid EZ Rubber-Based Supports

### NVENT CADDY PYRAMID EZ RUBBER-BASED ADJUSTABLE SUPPORT

- Quick height adjustment accommodates for uneven roofs or sloped condensate lines
- No tools or fasteners needed; fast snap-on installation
- Design sheds water and helps reduce pipe corrosion
- Roof-friendly; made of UV-stabilized EPDM material



Material: EPDM-SBR Rubber

Part #	Description			Cert
RPSE1H24	1" Rigid/Pipe, 1.315" OD, 1 3/4"-4"	170 lb	20 pc	ITB
RPSE1H57	1" Rigid/Pipe, 1.315" OD, 5"-7"	170 lb	10 pc	
RPSE2H46	2" Rigid/Pipe, 2.37" OD, 4"-6"	250 lb	10 pc	ITB
RPSE4H46	4" Rigid/Pipe, 4.5" OD, 4"-6"	400 lb	5 pc	ITB

Ultimate load at 1/4" (6.35 mm) deflection. Contact project or roofing engineer for maximum allowable load on individual project roof system.

### NVENT CADDY PYRAMID EZ RUBBER-BASED SUPPORT

- No tools or fasteners needed; fast snap-on installation
- Design sheds water and helps reduce pipe corrosion
- Roof-friendly; made of UV-stabilized EPDM material



Material: EPDM-SBR Rubber

Part #	Description		
RPSE1H	1" Rigid/Pipe, 1.315" OD, 1"	170 lb	20 pc

Ultimate load at 1/4" (6.35 mm) deflection. Contact project or roofing engineer for maximum allowable load on individual project roof system.

nVent CADDY Pyramid

# NVENT CADDY PYRAMID ROOFTOP SYSTEMS

## nVent CADDY Pyramid Universal Support

### NVENT CADDY PYRAMID TOOL-FREE PIPE SUPPORT KIT

- Push-in clamps install without the need for additional tools or strut clamps
- Ready to use out of the box, saving installation time and labor
- Plastic clamps and base will not corrode pipe
- Clamps come in two different sizes to fit project needs
- Base includes multiple holes to accommodate a variety of clamp sizes and configurations
- Additional clamps can be purchased separately for additional pipe runs
- Foam bottom offers low abrasion interface for better roof membrane protection
- Provides superior load distribution, even with varying rooftop surfaces
- Compatible with roof surfaces including single ply, bituminous, metal and spray foam
- Multiple sizes and load ratings offer the ability to tailor the solution to the application
- Easy to transport to the roof
- Supports green building requirements; thermoplastic bases are made from recycled material and can contribute to earning LEED credits



Material: Polyethylene, Polypropylene, Nylon

Temperature: -50 to 150 °F

Static Load Safety Factor: 3:1

nVent CADDY Pyramid

Part #	Description	
PTF6	8"	20 pc
PTF10	12 1/2"	10 pc
PTF16	19"	5 pc

Part #	Number of Clamps Included		Maximum Clamp Capacity	
	Part #	Part #	Part #	Part #
PTF6	1	1	3	1
PTF10	-	2	5	2
PTF16	-	2	7	3



# NVENT CADDY PYRAMID ROOFTOP SYSTEMS

## nVent CADDY Pyramid Tool-Free Supports

### NVENT CADDY PYRAMID TOOL-FREE PIPE CLAMP

- Push-in clamps install without the need for additional tools or strut clamps
- Clamps come in two different sizes to fit project needs
- Plastic clamps and base will not corrode pipe



Material: Nylon  
 Temperature: -50 to 150 °F

Part #	Description	
PTF1C	0.5"–1.32" OD	100 pc
PTF2C	0.84"–2.38" OD	100 pc

### NVENT CADDY PYRAMID UNIVERSAL SUPPORT

- Captive stainless steel nuts allow for custom attachment methods to the support base including easy attachment of stainless steel strut, threaded rod or other project-specific hardware
- Foam bottom offers low abrasion interface for better roof membrane protection
- Compatible with roof surfaces including single ply, bituminous, metal and spray foam
- Provides superior load distribution, even with varying rooftop surfaces
- Multiple sizes and load ratings offer the ability to tailor the solution to the application
- Includes square holes for creating an H-Frame with a 12" (305 mm) cross support (PBU16 only)
- Base is manufactured from UV-stabilized thermoplastic material
- Supports green building requirements; thermoplastic bases are made from recycled material and can contribute to earning LEED credits



nVent CADDY Pyramid

Material: Polyethylene, Polypropylene, Stainless Steel 18-8 (EN 1.4305)  
 Temperature: -50 to 150 °F  
 Static Load Safety Factor: 3:1

Part #	Description	
PBU6	5 1/2" x 4"	20 pc
PBU10	10" x 4"	10 pc
PBU16	16" x 4"	5 pc

# NVENT CADDY PYRAMID ROOFTOP SYSTEMS



## nVent CADDY Pyramid 25 Pipe and Conduit Support, Plastic

### NVENT CADDY PYRAMID 25 PIPE AND CONDUIT SUPPORT, PLASTIC

- Simple solution for supporting small pipes or conduit runs
- Lightweight plastic construction
- UV resistant, designed and tested for outdoor use
- No tools or fasteners needed for installation
- Rounded edges to help protect the roof membrane



Material: Acrylonitrile Butadiene Styrene

Part #	Description			Cert
PPRPS25H4	4 7/16"	25 lb	25 pc	ITB
PPRPS25H6	6 7/16"	25 lb	20 pc	



nVent CADDY Speed Link

# NVENT CADDY SPEED LINK UNIVERSAL SUPPORT SYSTEM

## nVent CADDY Speed Link SLK System

### NVENT CADDY SPEED LINK SLK WITH ANGLE BRACKET

- Complete system includes wire, locking device and pre-assembled angle bracket end fitting
- Ideal for attaching to concrete, steel or wood surfaces
- Simple alternative to jack chain and additional hardware



Material: Steel, Zinc Alloy, Polypropylene  
 Finish: Electrogalvanized  
 Static Load Safety Factor: 5:1  
 Complies With: SMACNA HVAC-DCS



Part #	Description	F		Cert
Wire Rope Diameter: 1.5 mm				
SLK15L1AB	1.5 mm Wire, 3.3' Length	44 lb	20 pc	cULus, ITB
SLK15L2AB	1.5 mm Wire, 6.6' Length	44 lb	20 pc	cULus, ITB
SLK15L3AB	1.5 mm Wire, 9.9' Length	44 lb	20 pc	cULus, ITB
SLK15L5AB	1.5 mm Wire, 16.4' Length	44 lb	20 pc	cULus, ITB
Wire Rope Diameter: 2.0 mm				
SLK2L2AB	2 mm Wire, 6.6' Length	100 lb	10 pc	cULus, ITB
SLK2L3AB	2 mm Wire, 9.9' Length	100 lb	10 pc	cULus, ITB
SLK2L5AB	2 mm Wire, 16.4' Length	100 lb	10 pc	cULus, ITB
Wire Rope Diameter: 3.0 mm				
SLK3L5AB	3 mm Wire, 16.4' Length	200 lb	5 x 10 pc	
SLK3L7AB	3 mm Wire, 22.9' Length	200 lb	5 x 5 pc	
SLK3L10AB	3 mm Wire, 32.8' Length	200 lb	5 x 5 pc	

# NVENT CADDY SPEED LINK UNIVERSAL SUPPORT SYSTEM

## nVent CADDY Speed Link SLK System

### NVENT CADDY SPEED LINK SLK WITH SHOT-FIRE BRACKET

- Complete system includes wire, locking device and shot-fire bracket with pre-assembled drive pin from Powers Fasteners, Inc.
- Quickly and easily attaches to concrete, steel or composite metal decking
- Integrated pin installs easily using powder-actuated or single-shot gas-actuated tools
- ICC-ES ESR-2024 evaluation report available for drive pin from DEWALT®



Material: Steel, Zinc Alloy, Polypropylene  
 Finish: Electrogalvanized  
 Static Load Safety Factor: 5:1  
 Complies With: SMACNA HVAC-DCS



Part #	Description	F	
Wire Rope Diameter: 1.5 mm			
SLK15L1SF	1.5 mm Wire, 3.3' Length	44 lb	20 pc
SLK15L2SF	1.5 mm Wire, 6.6' Length	44 lb	20 pc
SLK15L3SF	1.5 mm Wire, 9.9' Length	44 lb	20 pc
SLK15L5SF	1.5 mm Wire, 16.4' Length	44 lb	20 pc
Wire Rope Diameter: 2.0 mm			
SLK2L2SF	2 mm Wire, 6.6' Length	100 lb	10 pc
SLK2L3SF	2 mm Wire, 9.9' Length	100 lb	10 pc

Uses Powers Fasteners, Inc. part number 50032. Static load was established based on a 1" (25.4 mm) embedment depth and 3,000 psi (20.68 MPa) lightweight concrete. For variations in embedment and material please consult anchors.dewalt.com. Pre-assembled drive pin from Powers Fasteners, Inc. works with Powers® C4CZ, Simpson® GCN-MEPKT, SPIT® P1000, P200, P2201, P3500 / PA3500, P35s, P45, P60, P7201, Sniper; Ramset® 721, Cobra, D45 / D60 / D60L, M70, SA270, T3SS, TS750P, TS60P, Viper; Hilti® DX35, DX350 / DX351 / DX36M, DX100 / DX200, DX460, DXA40, DXA41, DXE72 / DX400; Würth® Diva-1, BST-1, BST-2 or equivalent nailers. For shot-fired supports in seismic design category D, E, or F, maximum load is the lesser of 90 lb (400 N) or the published load.

nVent CADDY Speed Link

# NVENT CADDY SPEED LINK UNIVERSAL SUPPORT SYSTEM

## nVent CADDY Speed Link SLK System

### NVENT CADDY SPEED LINK SLK WITH NAIL GUN BRACKET

- Complete system includes wire, locking device and concrete nail gun insert bracket
- Clips onto nozzle of gas or battery-actuated nail guns allowing for hands-off installation at structure or from the floor using a pole
- Longer leg angle bracket for tool clearance
- Quickly and easily attaches to concrete, steel or composite metal decking



Material: Steel, Zinc Alloy, Polypropylene  
Finish: Electrogalvanized  
Static Load Safety Factor: 5:1

Part #	Description	F ↓	📦
Wire Rope Diameter: 1.5 mm			
SLK15L2GBSF	1.5 mm Wire, 6.6' Length	44 lb	20 pc
SLK15L3GBSF	1.5 mm Wire, 9.9' Length	44 lb	20 pc
Wire Rope Diameter: 2.0 mm			
SLK2L2GBSF	2 mm Wire, 6.6' Length	100 lb	10 pc
SLK2L3GBSF	2 mm Wire, 9.9' Length	100 lb	10 pc

Static Load represents the static load of the nail gun insert assembly. Please consult with the nail manufacturer to evaluate the static load of the nail and type of concrete used for the installation. Maximum load is the lesser of the static load from the nail manufacturer or the published load for the assembly. Nail gun insert is compatible with BeA® CN60-688ES, Hilti® BX 3, GX 3, DEWALT® Trak-It C3, SPIT® PULSA 800E, 700, 1000 or equivalent nailers.

# NVENT CADDY SPEED LINK UNIVERSAL SUPPORT SYSTEM

## nVent CADDY Speed Link SLK System

### NVENT CADDY SPEED LINK SLK WITH DECKING HOOK

- Complete system includes wire, locking device and pre-assembled decking hook end fitting
- Quickly and easily attaches to hollow metal decking
- Spring-loaded ends snap into decking hole and lock into place
- Innovative design helps protect the wire from sharp edges of decking hole, minimizing risk of damage to wire



Material: Steel, Zinc Alloy, Polypropylene  
 Finish: Electrogalvanized  
 Static Load Safety Factor: 5:1  
 Complies With: SMACNA HVAC-DCS



Part #	Description	F ↓	↓ Cube
Wire Rope Diameter: 1.5 mm			
SLK15L2DH	1.5 mm Wire, 6.6' Length	44 lb	5 x 20 pc
SLK15L3DH	1.5mm Wire, 9.9' Length	44 lb	20 pc
SLK15L5DH	1.5 mm Wire, 16.4' Length	44 lb	20 pc
Wire Rope Diameter: 2.0 mm			
SLK2L3DH	2mm Wire, 9.9' Length	100 lb	10 pc
SLK2L5DH	2 mm Wire, 16.4' Length	100 lb	10 pc

Load rating is only applicable if the load-bearing capacity of the supporting element (steel decking) is adequate. Check with deck manufacturer for recommended load capacity.

# NVENT CADDY SPEED LINK UNIVERSAL SUPPORT SYSTEM

## nVent CADDY Speed Link SLK System

### **NVENT CADDY SPEED LINK SLK WITH HAMMER-ON FLANGE CLIP**

- Complete system includes wire, locking device and pre-assembled nVent CADDY Hammer-On Flange Clip end fitting
- Installs with just a hammer
- Fits most beams



Material: Steel, Polypropylene, Zinc Alloy  
 Finish: Electrogalvanized  
 Static Load Safety Factor: 5:1  
 Complies With: SMACNA HVAC-DCS



Part #	Description	F ↓	⊞
Wire Rope Diameter: 1.5 mm			
SLK15L34H24	1.5 mm Wire, 9.9' Length, 1/8"-1/4" Flange	44 lb	20 pc
SLK15L34H58	1.5 mm Wire, 9.9' Length, 5/16"-1/2" Flange	44 lb	20 pc
Wire Rope Diameter: 2.0 mm			
SLK2L34H24	2 mm Wire, 9.9' Length, 1/8"-1/4" Flange	100 lb	10 pc
SLK2L34H58	2 mm Wire, 9.9' Length, 5/16"-1/2" Flange	100 lb	10 pc



# NVENT CADDY SPEED LINK UNIVERSAL SUPPORT SYSTEM

## nVent CADDY Speed Link SLK System

### NVENT CADDY SPEED LINK SLK WITH HOOK

- Complete system includes wire, locking device and pre-assembled hook end fitting
- Hooks to a wide range of nVent CADDY fasteners
- Fastens to the building structure or hanging services by looping around and hooking to wire rope
- Easy to remove for applications requiring maintenance
- Spring latch helps provide secure connection
- Insert cable through hole and use bottom side of hook as an end stop
- Also available in Y-hook configuration



Material: Steel, Polypropylene, Zinc Alloy  
 Finish: Electrogalvanized  
 Static Load Safety Factor: 5:1



Part #	Description		Cert	
<b>Wire Rope Diameter: 1.5 mm</b>				
SLK15L1	1.5 mm Wire, 3.3' Length	20 pc	cULus, SMACNA	
SLK15L2	1.5 mm Wire, 6.6' Length	20 pc		
SLK15L2R2	1.5 mm Wire, 6.6' Length	15 x 2 pc		
SLK15L3	1.5 mm Wire, 9.9' Length	20 pc		
SLK15L3R2	1.5 mm Wire, 9.9' Length	15 x 2 pc		
SLK15L5	1.5 mm Wire, 16.4' Length	20 pc		
SLK15L5R2	1.5 mm Wire, 16.4' Length	15 x 2 pc		
SLK15L10	1.5 mm Wire, 32.8' Length	20 pc		
<b>Wire Rope Diameter: 2.0 mm</b>				
SLK2L1	2 mm Wire, 3.3' Length	10 pc		cULus, SMACNA
SLK2L2	2 mm Wire, 6.6' Length	10 pc		
SLK2L2R2	2 mm Wire, 6.6' Length	15 x 2 pc		
SLK2L3	2 mm Wire, 9.9' Length	10 pc		
SLK2L3R2	2 mm Wire, 9.9' Length	15 x 2 pc		
SLK2L5	2 mm Wire, 22.9' Length	10 pc		
SLK2L7	2 mm Wire, 22.9' Length	10 pc		
SLK2L10	2 mm Wire, 32.8' Length	10 pc		
<b>Wire Rope Diameter: 3.0 mm</b>				
SLK3L1	3 mm Wire, 3.3' Length	10 pc	SMACNA	
SLK3L2	3 mm Wire, 6.6' Length	10 pc		
SLK3L3	3 mm Wire, 9.9' Length	10 pc		
SLK3L3R2	3 mm Wire, 9.9' Length	10 x 2 pc		
SLK3L5	3 mm Wire, 16.4' Length	10 pc		
SLK3L5R2	3 mm Wire, 16.4' Length	15 x 2 pc		
SLK3L10	3 mm Wire, 32.8' Length	10 pc		

nVent CADDY Speed Link

# NVENT CADDY SPEED LINK UNIVERSAL SUPPORT SYSTEM

## nVent CADDY Speed Link SLK System

### NVENT CADDY SPEED LINK SLK WITH LOOP

- Complete system includes wire, locking device and pre-assembled loop end fitting
- Easy and flexible solution attaches to building structures
- Wire rope wraps around structure and through loop for quick installation
- Ideal for attaching to purlins, beams and other structural members
- Works well in tight or confined spaces
- Loop attaches directly to pipe, ductwork or other hanging assemblies



Material: Steel, Polypropylene, Zinc Alloy  
 Finish: Electrogalvanized  
 Static Load Safety Factor: 5:1



Part #	Description	F		Cert
Wire Rope Diameter: 1.5 mm				
SLK15L1LP	1.5 mm Wire, 3.3' Length	44 lb	20 pc	cULus, SMACNA
SLK15L1LPR2	1.5 mm Wire, 3.3' Length	44 lb	15 x 2 pc	
SLK15L2LP	1.5 mm Wire, 6.6' Length	44 lb	20 pc	
SLK15L2LPR2	1.5 mm Wire, 6.6' Length	44 lb	15 x 2 pc	
SLK15L3LP	1.5 mm Wire, 9.9' Length	44 lb	20 pc	
SLK15L3LPR2	1.5 mm Wire, 9.9' Length	44 lb	15 x 2 pc	
SLK15L5LP	1.5 mm Wire, 16.4' Length	44 lb	20 pc	
SLK15L5LPR2	1.5 mm Wire, 16.4' Length	44 lb	15 x 2 pc	
SLK15L7LP	1.5 mm Wire, 22.9' Length	44 lb	20 pc	
SLK15L10LP	1.5 mm Wire, 32.8' Length	44 lb	20 pc	
Wire Rope Diameter: 2.0 mm				
SLK2L1LP	2 mm Wire, 3.3' Length	100 lb	10 pc	cULus, SMACNA
SLK2L2LP	2 mm Wire, 6.6' Length	100 lb	10 pc	
SLK2L3LP	2 mm Wire, 9.9' Length	100 lb	10 pc	
SLK2L5LP	2 mm Wire, 16.4' Length	100 lb	10 pc	
SLK2L7LP	2 mm Wire, 22.9' Length	100 lb	5 pc	
SLK2L10LP	2 mm Wire, 32.8' Length	100 lb	5 pc	
Wire Rope Diameter: 3.0 mm				
SLK3L1LP	3 mm Wire, 3.3' Length	200 lb	10 x 10 pc	SMACNA
SLK3L2LP	3 mm Wire, 6.6' Length	200 lb	10 x 10 pc	
SLK3L3LP	3 mm Wire, 9.9' Length	200 lb	5 x 10 pc	
SLK3L5LP	3 mm Wire, 16.4' Length	200 lb	5 x 10 pc	
SLK3L10LP	3 mm Wire, 32.8' Length	200 lb	5 x 5 pc	

# NVENT CADDY SPEED LINK UNIVERSAL SUPPORT SYSTEM

## nVent CADDY Speed Link SLK System

### NVENT CADDY SPEED LINK SLK WITH THREADED STUD END

- Complete system includes wire, locking device and pre-assembled threaded stud end fitting
- Attaches to structures with threaded anchors or devices with threaded hole
- Connects directly to threaded devices in trapeze assemblies, light fixtures, HVAC assemblies or signage



Material: Steel, Polypropylene, Zinc Alloy  
 Finish: Electrogalvanized  
 Static Load Safety Factor: 5:1  
 Complies With: SMACNA HVAC-DCS



Part #	Description	F		Cert
Wire Rope Diameter: 1.5 mm				
SLK15L2SE250	1.5 mm Wire, 6.6' Length, 1/4" Rod	44 lb	20 pc	cULus
SLK15L3SE250	1.5 mm Wire, 9.9' Length, 1/4" Rod	44 lb	20 pc	cULus
SLK15L5SE250	1.5 mm Wire, 16.4' Length, 1/4" Rod	44 lb	20 pc	cULus
Wire Rope Diameter: 2.0 mm				
SLK2L2SE250	2 mm Wire, 6.6' Length, 1/4" Rod	100 lb	10 pc	cULus
SLK2L3SE375	2 mm Wire, 9.9' Length, 3/8" Rod	100 lb	10 pc	cULus
SLK2L5SE250	2 mm Wire, 16.4' Length, 1/4" Rod	100 lb	10 pc	cULus
SLK2L5SE375	2 mm Wire, 16.4' Length, 3/8" Rod	100 lb	10 pc	cULus
Wire Rope Diameter: 3.0 mm				
SLK3L1SE375	3 mm Wire, 3.3' Length, 3/8" Rod	200 lb	10 x 10 pc	
SLK3L2SE375	3 mm Wire, 6.6' Length, 3/8" Rod	200 lb	10 x 10 pc	
SLK3L3SE375	3 mm Wire, 9.9' Length, 3/8" Rod	200 lb	5 x 10 pc	
SLK3L7SE375	3 mm Wire, 22.9' Length, 3/8" Rod	200 lb	5 x 5 pc	

# NVENT CADDY SPEED LINK UNIVERSAL SUPPORT SYSTEM

## nVent CADDY Speed Link SLK System

### NVENT CADDY SPEED LINK SLK WITH WEDGE ANCHOR

- Complete system includes wire, locking device and wedge anchor from Powers Fasteners, Inc.
- Quickly and easily attaches into cracked and non-cracked concrete
- No special tools required



Material: Steel, Polypropylene, Zinc Alloy  
 Finish: Electrogalvanized  
 Static Load Safety Factor: 5:1  
 Complies With: SMACNA HVAC-DCS

Part #	Description	F ↓	📦
Wire Rope Diameter: 1.5 mm			
SLK15L1WA6	1.5 mm Wire, 3.3' Length	44 lb	5 x 20 pc
SLK15L2WA6	1.5 mm Wire, 6.6' Length	44 lb	5 x 20 pc
SLK15L5WA6	1.5 mm Wire, 16.4' Length	44 lb	5 x 20 pc
Wire Rope Diameter: 2.0 mm			
SLK2L2WA6	2 mm Wire, 6.6' Length	100 lb	10 pc
SLK2L3WA6	2 mm Wire, 9.9' Length	100 lb	10 pc
SLK2L5WA6	2 mm Wire, 16.4' Length	100 lb	10 pc
Wire Rope Diameter: 3.0 mm			
SLK3L2WA6	3 mm Wire, 6.6' Length	200 lb	10 pc
SLK3L5WA6	3 mm Wire, 16.4' Length	200 lb	10 pc
SLK3L10WA6	3 mm Wire, 32.8' Length	200 lb	5 pc

# NVENT CADDY SPEED LINK UNIVERSAL SUPPORT SYSTEM

## nVent CADDY Speed Link SLK System

### NVENT CADDY SPEED LINK SLK WITH TOGGLE

- Complete system includes wire, locking device and pre-assembled toggle end fitting
- Attaches to clearance holes in a variety of structures or hanging devices
- Ideal for supporting lighting fixtures
- Also available in Y-toggle configuration



Material: Steel, Zinc Alloy, Polypropylene  
 Finish: Electrogalvanized  
 Static Load Safety Factor: 5:1  
 Complies With: SMACNA HVAC-DCS  
 Wire Rope Diameter: 1.5 mm



Part #	Description	F ↓	📦
SLK15L1T	1.5 mm Wire, 3.3' Length	44 lb	20 pc
SLK15L1TR2	1.5 mm Wire, 3.3' Length	44 lb	15 x 2 pc
SLK15L2T	1.5 mm Wire, 6.6' Length	44 lb	20 pc
SLK15L2TR2	1.5 mm Wire, 6.6' Length	44 lb	15 x 2 pc
SLK15L3T	1.5 mm Wire, 9.9' Length	44 lb	20 pc
SLK15L3TR2	1.5 mm Wire, 9.9' Length	44 lb	15 x 2 pc
SLK15L5T	1.5 mm Wire, 16.4' Length	44 lb	20 pc
SLK15L7T	1.5 mm Wire, 22.9' Length	44 lb	20 pc
SLK15L10T	1.5 mm Wire, 32.8' Length	44 lb	20 pc

# NVENT CADDY SPEED LINK UNIVERSAL SUPPORT SYSTEM

## nVent CADDY Speed Link SLK System

### NVENT CADDY SPEED LINK SLK WITH Y-HOOK

- Complete system includes wire, locking device and two pre-assembled hook end fittings
- Fastens to the building structure and hooks to hanging services and tray
- Spring latch helps provide secure connection
- Convenient design allows one hook to be temporarily detached for maintenance or to add cables to the tray
- Single drop with double hook provides increased stability to the system
- Also available in a single-hook end fitting configuration



Material: Steel, Zinc Alloy, Polypropylene  
 Finish: Electrogalvanized  
 Static Load Safety Factor: 5:1  
 Complies With: SMACNA HVAC-DCS  
 Wire Rope Diameter: 2 mm



Part #	Description	F ↓	↓ Cube
SLK2YH500L2	6.6' Length, 19.6" Y-Length	100 lb	10 pc
SLK2YH500L2R2	6.6' Length, 19.6" Y-Length	100 lb	15 x 2 pc
SLK2YH500L3	9.9' Length, 19.6" Y-Length	100 lb	10 pc
SLK2YH500L3R2	9.9' Length, 19.6" Y-Length	100 lb	15 x 2 pc
SLK2YH500L7	22.3' Length, 19.6" Y-Length	100 lb	10 pc

# NVENT CADDY SPEED LINK UNIVERSAL SUPPORT SYSTEM

## nVent CADDY Speed Link SLK System

### NVENT CADDY SPEED LINK SLK WITH Y-TOGGLE

- Complete system includes wire, locking device and two pre-assembled toggle end fittings
- Attaches to clearance holes in a variety of structures or hanging devices
- Ideal for supporting lighting fixtures



Material: Steel, Zinc Alloy, Polypropylene  
 Finish: Electrogalvanized  
 Static Load Safety Factor: 5:1  
 Complies With: SMACNA HVAC-DCS



Part #	Description	F ↓	☐
Wire Rope Diameter: 1.5 mm			
SLK15Y300L3	1.5 mm Wire, 9.9' Length, 11.8" Y-Length	44 lb	20 pc
SLK15Y300L3R2	1.5 mm Wire, 9.9' Length, 11.8" Y-Length	44 lb	20 x 2 pc
SLK15Y500L3	1.5 mm Wire, 9.9' Length, 19.6" Y-Length	44 lb	20 pc
SLK15Y500L3R2	1.5 mm Wire, 9.9' Length, 19.6" Y-Length	44 lb	15 x 2 pc
SLK15Y300L5	1.5 mm Wire, 16.4' Length, 11.8" Y-Length	44 lb	20 pc
Wire Rope Diameter: 2.0 mm			
SLK2Y300L2	2 mm Wire, 6.6' Length, 11.8" Y-Length	100 lb	10 pc
SLK2Y300L3	2 mm Wire, 9.9' Length, 11.8" Y-Length	100 lb	10 pc
SLK2Y300L3R2	2 mm Wire, 9.9' Length, 11.8" Y-Length	100 lb	15 x 2 pc
SLK2Y500L3	2 mm Wire, 9.9' Length, 19.6" Y-Length	100 lb	10 pc
SLK2Y300L5	2 mm Wire, 16.4' Length, 11.8" Y-Length	100 lb	10 pc
SLK2Y300L7	2 mm Wire, 22.9' Length, 11.8" Y-Length	100 lb	10 pc
SLK2Y300L10	2 mm Wire, 32.8' Length, 11.8" Y-Length	100 lb	10 pc

# NVENT CADDY SPEED LINK UNIVERSAL SUPPORT SYSTEM

## nVent CADDY Speed Link SLS System

### NVENT CADDY SPEED LINK SLS WITH DECKING HOOK

- Complete system includes wire, locking device and pre-assembled decking hook end fitting
- Quickly and easily attaches to hollow metal decking
- Spring-loaded ends snap into decking hole and lock into place
- Innovative design helps protect the wire from sharp edges of decking hole, minimizing risk of damage to wire
- Finger tightening of nut secures the locking device into position without tools
- Installs in strut profiles without the need to insert fingers or tools into the strut



Material: Steel, Zinc Alloy, Polypropylene  
Finish: Electrogalvanized  
Static Load Safety Factor: 5:1  
Complies With: SMACNA HVAC-DCS  
Wire Rope Diameter: 2 mm



Part #	Description	F	
SLS2L3DH	2 mm Wire, 9.9' Length	60 lb	10 pc
SLS2L7DH	2 mm Wire, 22.9' Length	60 lb	10 pc

The 2 mm locking device is compatible with C-Channel Types E0 and E0L.  
Total load per wire on a multi-tier trapeze must not exceed static load.  
Load rating is only applicable if the load-bearing capacity of the supporting element (steel decking) is adequate. Check with deck manufacturer for recommended load capacity.



# NVENT CADDY SPEED LINK UNIVERSAL SUPPORT SYSTEM

## nVent CADDY Speed Link SLS System

### NVENT CADDY SPEED LINK SLS WITH HOOK

- Complete system includes wire, locking device and pre-assembled hook end fitting
- Hooks to a wide range of nVent CADDY fasteners
- Fastens to the building structure or hanging services by looping around and hooking to wire rope
- Easy to remove for applications requiring maintenance
- Spring latch helps provide secure connection
- Insert cable through hole and use bottom side of hook as an end stop
- Finger tightening of nut secures the locking device into position without tools
- Installs in strut profiles without the need to insert fingers or tools into the strut



Material: Steel, Zinc Alloy, Polypropylene  
 Finish: Electrogalvanized  
 Static Load Safety Factor: 5:1  
 Complies With: SMACNA HVAC-DCS



Part #	Description	
Wire Rope Diameter: 2 mm		
SLS2L1	2 mm Wire, 3.3' Length	10 pc
SLS2L2	2 mm Wire, 6.6' Length	10 pc
SLS2L3	2 mm Wire, 9.9' Length	10 pc
SLS2L10	2 mm Wire, 32.8' Length	10 pc
Wire Rope Diameter: 3 mm		
SLS3L1	3 mm Wire, 3.3' Length	10 x 10 pc
SLS3L2	3 mm Wire, 6.6' Length	10 x 10 pc
SLS3L3	3 mm Wire, 9.9' Length	10 x 5 pc
SLS3L5	3 mm Wire, 16.4' Length	10 x 5 pc
SLS3L7	3 mm Wire, 22.9' Length	5 x 5 pc
SLS3L10	3 mm Wire, 32.8' Length	5 x 5 pc

The 2 mm locking device is compatible with C-Channel Types E0 and E0L.  
 The 3 mm locking device is compatible with C-Channel Types E1, E2, E2L, E3, E4, E5, Strut Channel Type C, Slotted, Strut Channel Type A, Slotted, Strut Channel Type AS, Perforated, Strut Channel Type CC, Slotted, Strut Channel Type AA, Slotted. Total load per wire on a multi-tier trapeze must not exceed static load.

nVent CADDY Speed Link

# NVENT CADDY SPEED LINK UNIVERSAL SUPPORT SYSTEM

## nVent CADDY Speed Link SLS System

### NVENT CADDY SPEED LINK SLS WITH THREADED STUD END

- Complete system includes wire, locking device and pre-assembled threaded stud end fitting
- Attaches to structures with threaded anchors or devices with threaded hole
- Finger tightening of nut secures the locking device into position without tools
- Installs in strut profiles without the need to insert fingers or tools into the strut



Material: Steel, Polypropylene, Zinc Alloy  
Finish: Electrogalvanized  
Static Load Safety Factor: 5:1  
Complies With: SMACNA HVAC-DCS  
Wire Rope Diameter: 2 mm



Part #	Description	F	
SLS2L2SE250	2 mm Wire, 6.6' Length, 1/4" Rod	60 lb	10 pc
SLS2L3SE250	2 mm Wire, 9.9' Length, 1/4" Rod	60 lb	10 pc
SLS2L5SE250	2 mm Wire, 16.4' Length, 1/4" Rod	60 lb	10 pc

The 2 mm locking device is compatible with C-Channel Types E0 and E0L.  
Total load per wire on a multi-tier trapeze must not exceed static load.

# NVENT CADDY SPEED LINK UNIVERSAL SUPPORT SYSTEM

## nVent CADDY Speed Link SLS System

### NVENT CADDY SPEED LINK SLS WITH WEDGE ANCHOR

- Complete system includes wire, locking device and wedge anchor from Powers Fasteners, Inc.
- Quickly and easily attaches into cracked and non-cracked concrete
- Installs in strut profiles without the need to insert fingers or tools into the strut
- Finger tightening of nut secures the locking device into position without tools
- No special tools required
- ETA-13/0106 assessment available for wedge anchor from Powers Fasteners, Inc



Material: Steel, Polypropylene, Zinc Alloy  
 Finish: Electrogalvanized  
 Static Load Safety Factor: 5:1  
 Complies With: SMACNA HVAC-DCS  
 Wire Rope Diameter: 2 mm



Part #	Description	F ↓	↓ ↓
SLS2L3WA6	2 mm Wire, 9.9' Length	60 lb	10 pc
SLS2L5WA6	2 mm Wire, 16.4' Length	60 lb	10 pc

The 2 mm locking device is compatible with C-Channel Types E0 and E0L.  
 Total load per wire on a multi-tier trapeze must not exceed static load.

nVent CADDY Speed Link

# NVENT CADDY SPEED LINK UNIVERSAL SUPPORT SYSTEM

## nVent CADDY Speed Link SLS System

### NVENT CADDY SPEED LINK SLS TRAPEZE KIT

- Out of the box trapeze solution includes Telescoping Strut Replacement, wire rope with pre-assembled hook end-fitting, and two nVent CADDY Speed Link SLS locking devices
- Telescopes to the desired length and is locked in place by snapping closed a spring retainer clip
- Standard strut profile runs the entire length of the Telescoping Strut Replacement, allowing most standard fittings to be placed anywhere between the wire rope supports
- Supports up to seven 2" (50 DN) conduits, six 2" (50 DN) water filled pipes at 10' (3 m) spacing, or up to 18" (450 mm) cable tray
- Conduit and pipe can be placed directly on the strut profile, saving vertical space in buildings with limited room for installation
- Fastens to the building structure or hanging services by looping around and hooking to wire rope
- Hooks to a wide range of nVent CADDY fasteners
- Finger tightening of nut secures the locking device into position without tools
- Installs in telescoping strut replacement without the need to insert fingers or tools into the channel
- Easy to remove for applications requiring maintenance



Material: Steel, Zinc Alloy, Polyamide  
Finish: Electrogalvanized, Pregalvanized  
Wire Rope Diameter: 3 mm

Part #	Description	
TSR1220SLS3	nVent CADDY Speed Link SLS Trapeze Kit	10 pc

Static Load 1 represents a distributed load for 12" - 20" (300 - 500 mm) installations and a point load for 12" - 16" (300 - 400 mm) installations. Static Load 2 represents a point load for 16" - 20" (400 - 500 mm) installations.

# nVent CADDY SPEED LINK UNIVERSAL SUPPORT SYSTEM

## nVent CADDY Speed Link LD System

### nVent CADDY SPEED LINK LD WITH HOOK

- Complete system includes wire, locking device and pre-assembled hook end fitting
- Hooks to a wide range of nVent CADDY fasteners
- Fastens to the building structure or hanging services by looping around and hooking to wire rope
- Easy to remove for applications requiring maintenance
- Spring latch helps provide secure connection
- Insert cable through hole and use bottom side of hook as an end stop



Material: Stainless Steel 316 (DIN 1.4401)  
 Static Load Safety Factor: 5:1  
 Wire Rope Diameter: 1.5 mm



Part #	Description	F	Icon
SLD15L2S	1.5 mm Wire, 6.6' Length	44 lb	20 x 2 pc
SLD15L5S	1.5 mm Wire, 16.4' Length	44 lb	20 x 2 pc
SLD15L10S	1.5 mm Wire, 32.8' Length	44 lb	20 x 2 pc

### nVent CADDY SPEED LINK Y-HOOK WITH EYELET EXTENSION

- Double hook offers easy attachment to basket tray, cable tray or lighting
- Convenient design allows one hook to be temporarily detached for maintenance or to add cables to the tray
- Y-design provides improved stability
- Spring latch helps provide secure connection

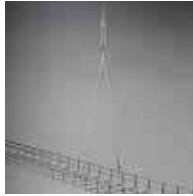

Material: Steel  
 Finish: Electrogalvanized  
 Static Load Safety Factor: 5:1



Part #	Description	F	Icon	Cert
Wire Rope Diameter: 2 mm				
SLD2YH500	2 mm Wire, 19.6" Y-Length	100 lb	10 pc	cULus, ITB
SLD2YH800	2 mm Wire, 31.4" Y-Length	100 lb	10 pc	cULus
Wire Rope Diameter: 3 mm				
SLD3YH500	3 mm Wire, 19.6" Y-Length	200 lb	10 pc	cULus
SLD3YH800	3 mm Wire, 31.4" Y-Length	200 lb	20 pc	cULus, ITB

nVent CADDY Speed Link locking device not included.

nVent CADDY Speed Link

# NVENT CADDY SPEED LINK UNIVERSAL SUPPORT SYSTEM

## nVent CADDY Speed Link Extensions



### NVENT CADDY SPEED LINK Y-TOGGLE WITH EYELET EXTENSION

- Attaches to clearance holes in a variety of structures or hanging devices
- Ideal for supporting lighting fixtures
- Y-design provides improved stability



Material: Steel  
 Finish: Electrogalvanized  
 Static Load Safety Factor: 5:1



Part #	Description			Cert
Wire Rope Diameter: 1.5 mm				
SLD15Y200	1.5 mm Wire, 7.8" Y-Length	44 lb	20 pc	cULus
SLD15Y300	1.5 mm Wire, 11.8" Y-Length	44 lb	20 pc	cULus
SLD15Y500	1.5 mm Wire, 19.6" Y-Length	44 lb	20 pc	cULus, ITB
SLD15Y800	1.5 mm Wire, 31.4" Y-Length	44 lb	20 pc	cULus, ITB
Wire Rope Diameter: 2.0 mm				
SLD2Y300	2 mm Wire, 11.8" Y-Length	100 lb	20 pc	cULus
SLD2Y500	2 mm Wire, 19.6" Y-Length	100 lb	20 pc	cULus, ITB

nVent CADDY Speed Link locking device not included.



### NVENT CADDY SPEED LINK QUAD-TOGGLE WITH EYELET EXTENSION

- Secure hanging solution for use on control access points, projectors, etc.



Material: Steel  
 Finish: Electrogalvanized  
 Static Load Safety Factor: 5:1



Part #	Description		
SLD15QT250	1.5 mm Wire, 9.8" Y-Length	44 lb	20 pc

nVent CADDY Speed Link locking device not included.

# NVENT CADDY SPEED LINK UNIVERSAL SUPPORT SYSTEM

## nVent CADDY Speed Link Extensions

### NVENT CADDY SPEED LINK SLK SPOOL KIT

- Kit includes spool of nVent CADDY Speed Link steel wire and nVent CADDY Speed Link SLK locking devices
- Wire spool and locking devices are packaged together, simplifying transportation to the jobsite and reducing inventory
- Packaging allows end-users to pull and cut any length of wire that is needed without having to take the spool out of the box
- Ideal for rework and installations where custom lengths of wire may be needed
- Wire rope constructed from seven bundles of seven strands each of steel aircraft wire
- Push/pull keyless release allows easy adjustments
- Low-profile locking device minimizes visual impact
- Cable spread of 90 degrees allows positioning the device closer to the load
- Keyless release tubes are easy to operate while wearing gloves
- Double-sided locking mechanism enables simple height adjustment



Material: Steel  
Finish: Electrogalvanized

Part #	Description
SLK15L500PACK	1.5mm Wire, 500', 100 Locking Devices
SLK15L50MPACK	1.5mm Wire, 164', 25 Locking Devices
SLK2L100PACK	2 mm Wire, 328', 50 Locking Devices

# NVENT CADDY SPEED LINK UNIVERSAL SUPPORT SYSTEM

## nVent CADDY Speed Link Locking Devices and Wire Rope

### NVENT CADDY SPEED LINK SLK LOCKING DEVICE

- Push/pull keyless release allows easy adjustments
- Low-profile locking device minimizes visual impact
- Cable spread of 90 degrees allows positioning the device closer to the load
- Keyless release tubes are easy to operate while wearing gloves
- Double-sided locking mechanism enables simple height adjustment



Material: Steel, Polypropylene, Zinc Alloy



Part #	Description		Cert
SLK2C200	1.5–2 mm Wire	200 pc	cULus, ITB
SLK2C50	1.5–2 mm Wire	50 pc	cULus
SLK3C200	3 mm Wire	200 pc	
SLK3C50	3 mm Wire	50 pc	

Locking devices are only to be used with nVent CADDY Speed Link wire spools and accessories with the same specified Wire Rope Diameter as the locking device. Do not use with any other wires.

### NVENT CADDY SPEED LINK LD LOCKING DEVICE

- Low-profile locking device minimizes visual impact
- Suitable for 1.5 mm nVent CADDY Speed Link cable



Material: Stainless Steel 304 (EN 1.4301)

Part #	Description	
SLJR200	Stainless Steel Hanger for 1.5mm Stainless Steel Wire Rope	200 pc

The 1.5 mm locking devices are only to be used with the SLC15L1000SP and SLC15L50MSP wire spools, or any other 1.5 mm nVent CADDY Speed Link accessories. Do not use with any other wires.



# NVENT CADDY SPEED LINK UNIVERSAL SUPPORT SYSTEM

## nVent CADDY Speed Link Locking Devices and Wire Rope

### NVENT CADDY SPEED LINK SLS LOCKING DEVICE

- Single barrel locking device allows for quick prefabrication of strut or brackets
- Push-on nut quickly and securely installs to strut or bracket to keep the locking device in position and eases installation
- Finger tightening of nut secures the locking device into position without tools
- Installs in strut profiles without the need to insert fingers or tools into the strut
- Push-on nut guides the cable into the locking device and brings stability to the support
- Installs with open side of the strut channel facing up or down for more flexibility



Material: Steel, Polypropylene, Zinc Alloy

Part #	Description	
SLS2C50	2 mm Wire	50 pc
SLS3C50	3 mm Wire	50 pc

The 2 mm locking device is compatible with C-Channel Types E0 and E0L. The 3 mm locking device is compatible with C-Channel Types E1, E2, E2L, E3, E4, E5, Strut Channel Type C, Slotted, Strut Channel Type A, Slotted, Strut Channel Type AS, Perforated, Strut Channel Type CC, Slotted, Strut Channel Type AA, Slotted. Locking devices are only to be used with nVent CADDY Speed Link wire spools and accessories with the same specified Wire Rope Diameter as the locking device. Do not use with any other wires.

### WIRE SPOOL

- Spool with nVent CADDY Speed Link steel wire
- Wire rope constructed from seven bundles of seven strands each of steel aircraft wire



nVent CADDY Speed Link

Material: Steel  
Finish: Electrogalvanized

Part #	Description	
SLC15L50MSP	1.5 mm Wire, 164'	44 lb
SLC15L1000SP	1.5 mm Wire, 1000'	44 lb
SLC2L1000SP	2mm Wire, 1000'	100 lb
SLC3L1000SP	3 mm Wire, 1000'	200 lb

# NVENT CADDY SPEED LINK UNIVERSAL SUPPORT SYSTEM

## nVent CADDY Speed Link Locking Devices and Wire Rope

### WIRE ROPE CUTTER

- Designed to reduce wire rope fraying



Material: Steel

Part #	Description	
SLWC	Wire Rope Cutter	1 pc

### AIR DUCT CORNER PROTECTOR

- Includes rib to keep the wire rope in place
- Prevents the wire rope from damaging the duct

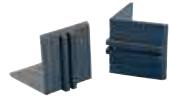

Material: Polyvinylchloride  
Color: Black

Part #	Description	
SLADCP	Air Duct Corner Protector	10 pc

### AIR DUCT SUPPORT ATTACHMENT

- Angled bracket for installation on to round or square duct
- Designed to accept nVent CADDY Speed Link wire rope or hook



Material: Steel  
Finish: Electrogalvanized

Part #	Description	
SLADS	Air Duct Support Attachment	100 pc

# nVent CADDY SPEED LINK UNIVERSAL SUPPORT SYSTEM

## nVent CADDY Speed Link Locking Devices and Wire Rope

### AIR DUCT BRACKET KIT

- Ideal for modular assembly – allows attachment of brackets to sections of duct while safely on the ground
- Ready to use out of the box and eliminates the need for cutting and preparing sections of strut
- Prevents the wire rope from damaging the duct
- Angle bracket for installation on to square duct
- Designed to be installed with nVent CADDY Speed Link SLS Locking Devices (both sizes)
- Includes self-tapping sheet metal screws to attach bracket to duct



**Innovative Solution**

Material: Steel  
Finish: Electrogalvanized

Part #	Description	
SLDBK	Air Duct Bracket Kit	50 pc

### ANGLE BRACKET WITH OBLONG HOLE

- 90° angle mounting bracket
- Suitable for shot firing or screw fixing
- With oblong hole to allow nVent CADDY Speed Link hook



Material: Steel  
Finish: Pregalvanized

Part #	Description		
SLAFAB3	3/16" Hole	200 lb	50 pc

nVent CADDY Speed Link

# NVENT CADDY SPEED LINK UNIVERSAL SUPPORT SYSTEM

## nVent CADDY Speed Link Accessories

### CONCRETE FIXING EYEBOLT SCREW

- For use in concrete and brick
- Includes drill bit adapter for easy installation



Material: Steel  
Finish: ElectroGalvanized

Part #	Description	F ↓	☐
CFEB05	0.256" Hole, H6 Screw	160 lb	100 pc

### WOOD FIXING EYE SCREW

- Designed to accept nVent CADDY Speed Link wire rope or hook



Material: Steel  
Finish: ElectroGalvanized

Part #	Description	☐
SLEBWS	Wood Fixing Eye Screw	100 pc

### EYE SCREW

- Designed to accept nVent CADDY Speed Link wire rope or hook



Material: Steel  
Finish: ElectroGalvanized

Part #	Description	☐
SLEB250	1/4" Screw	100 pc
SLEB375	3/8" Screw	100 pc

# Rigid Bracing System



# RIGID BRACING SYSTEM

## STEEL FLANGE ADAPTER

- Meets requirements of the Buy American Act
- Installs on top or bottom flange of I-beams or bar joists. Low profile easily fits between metal deck and steel structure
- Thumb spring retainer allows for ease of positioning
- Available pre-assembled to the Universal Structural Bracket, eliminating field assembly
- Snap-off bolt head helps enable easy installation and inspection of seismic sway braces
- Meets NFPA® 13 as pre-qualified for seismic applications



Material: Steel  
Finish: Electrogalvanized



Part #	Description	
CSBS1	1/4"–3/4" Flange	10 pc
CSBS2	3/4"–1 1/4" Flange	10 pc

UL Loads				
Part Number	Structure Attachment Fitting	Flange Thickness	Brace Member	Load Rating
CSBS1	CSBU1	1/4" - 3/8"	1" - 2" Sch. 40 NPS	1500 lb
		3/8" - 3/4"		1700 lb
	CSBURC12	1/4" - 3/4"	CSB12CBL	418 lb
			CSB18CBL	772 lb
			CSB36CBL	1100 lb
CSBS2	CSBU1	3/4" - 1-1/4"	1" - 2" Sch. 40 NPS	1700 lb
				CSB12CBL
	CSBURC12	3/4" - 1-1/4"	CSB18CBL	772 lb
			CSB36CBL	1100 lb

FM Approved Loads								
Part Number	Horizontal Capacity per Installation Angle from Vertical							
	Perpendicular to Structure				Parallel to Structure			
	30° - 44°	45° - 59°	60° - 74°	75° - 90°	30° - 44°	45° - 59°	60° - 74°	75° - 90°
CSBS1	850 lb	1,780 lb	2,770 lb	2,840 lb	880 lb	1,430 lb	2,020 lb	2,410 lb
CSBS2	1,220 lb	2,140 lb	2,580 lb	2,870 lb	1,100 lb	1,820 lb	2,190 lb	2,680 lb

# RIGID BRACING SYSTEM

## STEEL FLANGE ADAPTER ASSEMBLY

- Meets requirements of the Buy American Act
- Steel Flange Adapter and Universal Structural Bracket are preassembled, limiting work required in the field
- Installs on top or bottom flange of I-beams or bar joists. Low profile easily fits between metal deck and steel structure
- Thumb spring retainer allows for ease of positioning
- Integrated angle gauge easily displays brace member angle of installation
- Snap-off bolt head helps enable easy installation and inspection of seismic sway braces
- Works with 1" through 2" brace pipes to reduce inventory
- Meets NFPA® 13 as pre-qualified for seismic applications



Material: Steel  
Finish: Electrogalvanized



Part #	Description	
CSBS1A	1/4"-3/4" Flange	10 pc

UL Loads			
Part Number	Flange Thickness	Brace Member	Load Rating
CSBS1A	1/4" - 3/8"	1" - 2" Sch. 40 NPS	1,500 lb
	3/8" - 3/4"	1" - 2" Sch. 40 NPS	1,885 lb

FM Approved Loads								
Part Number	Horizontal Capacity per Installation Angle from Vertical							
	Perpendicular to Structure				Parallel to Structure			
	30° - 44°	45° - 59°	60° - 74°	75° - 90°	30° - 44°	45° - 59°	60° - 74°	75° - 90°
CSBS1A	850 lb	1,780 lb	2,770 lb	2,840 lb	880 lb	1,430 lb	2,020 lb	2,410 lb

# RIGID BRACING SYSTEM

## ADJUSTABLE I-BEAM ADAPTER

- Meets requirements of the Buy American Act
- No loose parts
- No assembly required
- Snap-off bolt head helps enable easy installation and inspection of seismic sway braces
- Meets NFPA®-13 requirements for seismic sway bracing



Material: Steel  
Finish: Electrogalvanized



Part #	Description	
CSBS3	EG, 1/4"-3/4" Flange, 4"-8 1/2"	10 pc
CSBS4	EG, 1/4"-3/4" Flange, 4"-14 1/2"	10 pc
CSBS5	EG, 3/4"-1 1/4" Flange, 4"-18"	10 pc

UL Loads				
Part Number	Structure Attachment Fitting	Flange Thickness	Brace Member	Load Rating
CSBS3	CSBU1	1/4" - 3/8"	1" - 2" Sch. 40 NPS	1500 lb
		3/8" - 3/4"		1700 lb
	CSBURC12	1/4" - 3/4"	CSB12CBL	418 lb
			CSB18CBL	772 lb
			CSB36CBL	1100 lb
CSBS4	CSBU1	1/4" - 3/8"	1" - 2" Sch. 40 NPS	1500 lb
		3/8" - 3/4"		1700 lb
	CSBURC12	1/4" - 3/4"	CSB12CBL	418 lb
			CSB18CBL	772 lb
			CSB36CBL	1100 lb
CSBS5	CSBU1	3/4" - 1-1/4"	1" - 2" Sch. 40 NPS	1700 lb
				CSB12CBL
	CSBURC12	3/4" - 1-1/4"	CSB18CBL	772 lb
			CSB36CBL	1100 lb

FM Approved Loads								
Part Number	Horizontal Capacity per Installation Angle from Vertical							
	Perpendicular to Structure				Parallel to Structure			
	30° - 44°	45° - 59°	60° - 74°	75° - 90°	30° - 44°	45° - 59°	60° - 74°	75° - 90°
CSBS3	1,180 lb	2,210 lb	2,830 lb	2,940 lb	820 lb	1,380 lb	2,080 lb	3,010 lb
CSBS4	1,180 lb	2,210 lb	2,830 lb	2,940 lb	820 lb	1,380 lb	2,080 lb	3,010 lb
CSBS5	1,220 lb	2,140 lb	2,580 lb	2,870 lb	1,100 lb	1,820 lb	2,190 lb	2,680 lb



# RIGID BRACING SYSTEM

## MULTI ATTACHMENT

- Disperses load over two anchors
- Minimizes the number of installed braces needed for concrete and wood structures
- Ideal for deck installations
- Use for both lateral and longitudinal sway brace applications
- Meets NFPA®-13 requirements for seismic sway bracing
- Meets CEN/TS 17551:2021 requirements for Seismic Sway Bracing



Material: Steel  
Finish: Electrogalvanized



Part #	Description	
CSBMA050050EG	9/16" Hole 1, 9/16" Hole 2	10 pc
CSBMA050075EG	13/16" Hole 1, 9/16" Hole 2	10 pc

UL Loads				
Part Number	Structure Attachment Fitting	Brace Member	Load Rating	
CSBMA050050	CSBU1	1" - 2" Sch. 40 NPS	680 lb	
	CSBUNIV050	1" - 2" Sch. 40 NPS	680 lb	
	CSBURC12	CSB12CBL	418 lb	
		CSB18CBL	772 lb	
		CSB36CBL	1100 lb	
	CSBNPC12	CSB12CBL	418 lb	
		CSB18CBL	772 lb	
		CSB36CBL	1300 lb	
	CSBMA050050	CSBU1	1" - 2" Sch. 40 NPS	680 lb
		CSBUNIV050	1" - 2" Sch. 40 NPS	680 lb
CSBURC12		CSB12CBL	418 lb	
		CSB18CBL	772 lb	
		CSB36CBL	1100 lb	
CSBNPC12		CSB12CBL	418 lb	
		CSB18CBL	772 lb	
		CSB36CBL	1300 lb	

FM Approved Loads				
Part Number	Horizontal Capacity per Installation Angle from Vertical			
	30° - 44°	45° - 59°	60° - 74°	75° - 90°
CSBMA050050EG	3,290 lb	4,520 lb	5,540 lb	6,200 lb
CSBMA050075EG	3,290 lb	4,520 lb	5,540 lb	6,200 lb

# RIGID BRACING SYSTEM

## STRUT SEISMIC HINGE BRACKET ASSEMBLY

- Used for installations where strut brace is parallel to structure
- One wrench size fits all required hardware, eliminating the need to change tools
- Shear-off head helps ensure correct torque and simplifies inspection
- Compatible with brace members of 12 GA strut type A



Material: Steel  
Finish: Electrogalvanized



Part #	Description	
CSBUS1PA	9/16" Hole	20 pc
CSBUS2PA	13/16" Hole	20 pc

FM Approved Loads						
Part Number	Brace Member	Horizontal Capacity per Installation Angle from Vertical				
		30° - 44°	45° - 59°	60° - 74°	75° - 90°	
CSBUS1PA	12 GA Strut Channel	1,160 lb	1,860 lb	1,860 lb	1,680 lb	
CSBUS2PA	12 GA Strut Channel	1,160 lb	1,860 lb	1,860 lb	1,680 lb	

# RIGID BRACING SYSTEM

## UNIVERSAL STRUCTURAL BRACKET

- Meets requirements of the Buy American Act
- Universal design allows one product to attach directly to concrete, wood, bar joist or I-beam adapters
- Integrated angle gauge easily displays brace member angle of installation
- Snap-off bolt head helps enable easy installation and inspection of seismic sway braces
- Works with 1" through 2" brace pipes to reduce inventory
- Low profile minimizes prying effect on concrete fasteners
- Meets NFPA® 13 as pre-qualified for seismic applications



Material: Steel  
Finish: Electrogalvanized



Part #	Description	UL Listed Load	
CSBU1	EG, 9/16" Hole	2,000 lb	25 pc
CSBU2	EG, 13/16" Hole	2,000 lb	25 pc

### FM Approved Loads

Part Number	Brace Member	Horizontal Capacity per Installation Angle from Vertical			
		30° - 44°	45° - 59°	60° - 74°	75° - 90°
CSBU1	Schedule 40 Pipe	1,690 lb	2,210 lb	2,660 lb	3,090 lb
	12 GA Strut Channel (Back)	1,450 lb	1,830 lb	1,870 lb	2,070 lb
	12 GA Strut Channel (Side)	1,000 lb	1,380 lb	1,830 lb	2,030 lb
CSBU2	Schedule 40 Pipe	1,480 lb	2,290 lb	2,860 lb	3,090 lb
	12 GA Strut Channel (Back)	1,450 lb	1,830 lb	1,870 lb	2,070 lb
	12 GA Strut Channel (Side)	1,000 lb	1,380 lb	1,830 lb	2,030 lb

### FM Specification Tested Loads

Part Number	Brace Member	Horizontal Capacity per Installation Angle from Vertical			
		30° - 44°	45° - 59°	60° - 74°	75° - 90°
CSBU1	1" EMT Conduit	530 lb	911 lb	1,108 lb	1,223 lb
	1" Rigid Conduit	530 lb	911 lb	1,108 lb	1,223 lb

# RIGID BRACING SYSTEM

## UNIVERSAL SWAY BRACE

- Meets requirements of the Buy American Act
- Use for both lateral and longitudinal sway brace applications
- Unique slotted holes provide for easy slip-on installation eliminating loose hardware
- Snap-off bolt head helps enable easy installation and inspection of seismic sway braces
- Works with 1" through 2" brace pipes to reduce inventory
- Meets NFPA®-13 requirements for seismic sway bracing
- Meets CEN/TS 17551:2021 requirements for Seismic Sway Bracing



Material: Steel  
Finish: Electrogalvanized



Part #	Description		Cert
CSB0100	1" Pipe	10 pc	cULus,
CSB0125	1 1/4" Pipe	10 pc	FM Approved,
CSB0150	1 1/2" Pipe	10 pc	Seismic,
CSB0200	2" Pipe	10 pc	OSHDP,
CSB0250	2 1/2" Pipe	10 pc	OSHDP/HCAI
CSB0300	3" Pipe	10 pc	
CSB0400	4" Pipe	10 pc	
CSB0500	5" Pipe	10 pc	
CSB0600	6" Pipe	10 pc	
CSB0800	8" Pipe	5 pc	
CSB1000	10" Pipe	5 pc	
CSB1200	12" Pipe	1 pc	FM Approved, Seismic, OSHDP/HCAI

FM® Specification Tested for 1-1/2" to 4" pipe sizes using no hub cast iron pipe. Load ratings for Sch 10 may also be applied to AS 1074 Medium, GB/T 3091, EN 10255 (Medium or Heavy), and JIS G3452 pipe. Load ratings for Sch 40 may also be applied to AS 1074 Heavy, GB/T 3091, EN 10255 (Heavy), and JIS G3454 pipe. Load ratings for FM approved lightwall may also be applied to AS 1074 Lightwall, EN 10255 L, EN 10220, and GB/T 8163 pipe.

# RIGID BRACING SYSTEM

## UL Loads

Part Number	Lateral, Service Pipe Type				Longitudinal, Service Pipe Type			
	Sch 10 / Sch 40	Bull Moose Eddy Flow	Wheatland Mega-Flow	Youngstown Fire-Flo	Sch 10 / Sch 40	Bull Moose Eddy Flow	Wheatland Mega-Flow	Youngstown Fire-Flo
CSB0100	1800 lb	N/A	N/A	N/A	1000 lb	N/A	N/A	N/A
CSB0125	1800 lb	1800 lb	1800 lb	N/A	680 lb	680 lb	680 lb	N/A
CSB0150	1800 lb	1800 lb	1800 lb	1800 lb	1000 lb	1000 lb	1000 lb	1000 lb
CSB0200	1800 lb	1800 lb	1800 lb	1800 lb	1300 lb	1300 lb	1300 lb	1300 lb
CSB0250	1800 lb	1800 lb	1800 lb	1800 lb	1300 lb	1300 lb	1300 lb	1300 lb
CSB0300	1800 lb	1800 lb	1800 lb	1800 lb	1400 lb	1400 lb	1400 lb	1400 lb
CSB0400	1800 lb	1800 lb	1800 lb	1800 lb	1700 lb	1700 lb	1700 lb	1700 lb
CSB0500	1800 lb	N/A	N/A	N/A	1700 lb	N/A	N/A	N/A
CSB0600	1800 lb	N/A	1800 lb	N/A	1700 lb	N/A	1700 lb	N/A
CSB0800	1800 lb	N/A	N/A	N/A	1700 lb	N/A	N/A	N/A
CSB1000	1900 lb	N/A	N/A	N/A	1900 lb	N/A	N/A	N/A
CSB1200	N/A	N/A	N/A	N/A	N/A	N/A	N/A	N/A

## FM Approved Loads

Part Number	Brace Member	Horizontal Capacity per Installation Angle from Vertical							
		Lateral				Longitudinal			
		30° - 44°	45° - 59°	60° - 74°	75° - 90°	30° - 44°	45° - 59°	60° - 74°	75° - 90°

### FM Approved Lightwall, Sch 10 and Sch 40 Service Pipes

CSB0100		1,490 lb	2,110 lb	2,580 lb	2,900 lb	1,290 lb	1,240 lb	1,260 lb	1,400 lb
CSB0125		1,380 lb	1,960 lb	2,400 lb	2,690 lb	1,290 lb	1,240 lb	1,260 lb	1,400 lb
CSB0150		1,380 lb	1,960 lb	2,400 lb	2,690 lb	1,200 lb	1,860 lb	2,180 lb	2,250 lb
CSB0200	1" - 2" Sch. 40	1,380 lb	1,960 lb	2,400 lb	2,690 lb	1,200 lb	1,820 lb	2,180 lb	2,250 lb
CSB0250		1,440 lb	2,030 lb	2,490 lb	2,790 lb	1,320 lb	1,820 lb	2,190 lb	2,500 lb
CSB0300		1,390 lb	1,970 lb	2,420 lb	2,710 lb	1,300 lb	1,790 lb	2,190 lb	2,500 lb
CSB0400		1,390 lb	1,970 lb	2,420 lb	2,710 lb	1,300 lb	1,790 lb	2,190 lb	2,500 lb
CSB0500		1,390 lb	1,970 lb	2,420 lb	2,710 lb	1,300 lb	1,790 lb	2,190 lb	2,500 lb
CSB0600		1,460 lb	2,060 lb	2,520 lb	2,830 lb	1,410 lb	1,950 lb	2,350 lb	2,680 lb
CSB0100		12 GA Strut	1,040 lb	1,470 lb	1,800 lb	2,010 lb	660 lb	580 lb	640 lb
CSB0125	1,040 lb		1,470 lb	1,800 lb	2,010 lb	1,320 lb	580 lb	640 lb	NR
CSB0150	1,580 lb		2,240 lb	2,740 lb	3,070 lb	890 lb	1,340 lb	1,620 lb	NR
CSB0200	1,580 lb		2,240 lb	2,740 lb	3,070 lb	890 lb	1,220 lb	1,830 lb	NR
CSB0250	1,620 lb		2,300 lb	2,820 lb	3,160 lb	890 lb	1,220 lb	1,830 lb	NR
CSB0300	1,520 lb		2,160 lb	2,640 lb	2,690 lb	890 lb	1,220 lb	1,830 lb	NR
CSB0400	1,520 lb		2,160 lb	2,640 lb	2,690 lb	1,340 lb	1,850 lb	2,350 lb	NR
CSB0500	1,520 lb		2,160 lb	2,640 lb	2,690 lb	1,340 lb	1,850 lb	2,350 lb	NR
CSB0600	1,570 lb		2,220 lb	2,720 lb	3,050 lb	1,540 lb	1,850 lb	2,350 lb	NR

### 0.188" Wall and Sch 40 Service Pipes

CSB0800	1" - 2" Sch. 40	1,330 lb	1,880 lb	2,300 lb	2,580 lb	1,400 lb	1,920 lb	2,350 lb	2,640 lb
CSB1000		1,330 lb	1,880 lb	2,300 lb	2,580 lb	1,400 lb	1,920 lb	2,350 lb	2,640 lb
CSB1200		1,680 lb	2,370 lb	2,910 lb	3,260 lb	1,600 lb	1,860 lb	2,240 lb	2,590 lb
CSB0800	12 GA Strut	1,410 lb	2,000 lb	2,450 lb	2,740 lb	1,270 lb	1,750 lb	2,160 lb	NR
CSB1000		1,410 lb	2,000 lb	2,450 lb	2,740 lb	1,270 lb	1,750 lb	2,160 lb	NR
CSB1200		1,460 lb	2,070 lb	2,530 lb	2,840 lb	1,390 lb	1,750 lb	2,110 lb	NR

# RIGID BRACING SYSTEM

## QUICK GRIP JR. LATERAL SWAY BRACE

- Easy two-step installation eliminates extra trips between structure and service pipe
- Works with 1" and 1 1/4" brace pipes to reduce inventory
- Snap-off bolt head helps enable easy installation and inspection of seismic sway braces
- Meets NFPA®-13 requirements for seismic sway bracing
- Meets CEN/TS 17551:2021 requirements for Seismic Sway Bracing



Material: Steel  
Finish: Electrogalvanized



Part #	Description	
CSBQIKCL0100EG	1" Pipe	25 pc
CSBQIKCL0125EG	1 1/4" Pipe	25 pc
CSBQIKCL0150EG	1 1/2" Pipe	25 pc
CSBQIKCL0200EG	2" Pipe	25 pc

## RIGID BRACING SYSTEM

### UL Loads (Listed for Restraints)

Part Number	Service Pipe Schedule	Lateral	
		1" Brace Pipe	1 1/4" Brace Pipe
CSBQIKCL0100EG	Dyna-Flow®	N/A	N/A
	10	655 lb	655 lb
	40	655 lb	655 lb
CSBQIKCL0125EG	Dyna-Flow®	655 lb	540 lb
	10	655 lb	540 lb
	40	655 lb	540 lb
CSBQIKCL0150EG	Dyna-Flow®	750 lb	655 lb
	10	750 lb	655 lb
	40	750 lb	655 lb
CSBQIKCL0200EG	Dyna-Flow®	750 lb	540 lb
	10	750 lb	540 lb
	40	750 lb	540 lb

### FM Approved Loads

Part Number	Service Pipe Schedule	Lateral			
		Horizontal Capacity per Installation Angle from Vertical			
		30° - 44°	45° - 59°	60° - 74°	75° - 90°
CSBQIKCL0100EG	Lightwall	290 lb	410 lb	495 lb	550 lb
	10	150 lb	210 lb	280 lb	315 lb
	40	475 lb	665 lb	825 lb	925 lb
CSBQIKCL0125EG	Lightwall	290 lb	410 lb	495 lb	550 lb
	10	150 lb	210 lb	280 lb	315 lb
	40	475 lb	665 lb	825 lb	925 lb
CSBQIKCL0150EG	Lightwall	290 lb	410 lb	495 lb	550 lb
	10	150 lb	210 lb	280 lb	315 lb
	40	475 lb	665 lb	825 lb	925 lb
CSBQIKCL0200EG	Lightwall	390 lb	550 lb	670 lb	750 lb
	10	350 lb	500 lb	620 lb	690 lb
	40	490 lb	690 lb	850 lb	950 lb

# RIGID BRACING SYSTEM

## QUICK GRIP LATERAL SWAY BRACE

- Easy two-step installation eliminates extra trips between structure and service pipe
- Works with 1" and 1 1/4" brace pipes to reduce inventory
- Yellow tips provide a visual indicator that the bolts have been properly torqued
- Easy installation with an impact wrench from the bottom side of the clamp
- Meets NFPA®-13 requirements for seismic sway bracing
- Meets CEN/TS 17551:2021 requirements for Seismic Sway Bracing



Material: Steel  
Finish: Electrogalvanized



Part #	Description	
CSBQG0250EG	2 1/2" Pipe	10 pc
CSBQG0300EG	3" Pipe	10 pc
CSBQG0400EG	4" Pipe	10 pc
CSBQG0600EG	6" Pipe	10 pc
CSBQG0800EG	8" Pipe	5 pc



## RIGID BRACING SYSTEM

### UL Loads

Part Number	Lateral, Service Pipe Type			
	Sch 10 / Sch 40	Bull Moose Eddy Flow	Wheatland Mega-Flow	Youngstown Fire-Flo
CSBQG0250	1500 lb	1500 lb	1500 lb	1500 lb
CSBQG0300	1300 lb	1300 lb	1300 lb	1300 lb
CSBQG0400	1500 lb	1500 lb	1500 lb	1500 lb
CSBQG0500	N/A	N/A	N/A	N/A
CSBQG0600	1400 lb	N/A	1400 lb	N/A
CSBQG0800	1400 lb	N/A	N/A	N/A

### FM Approved Loads

Part Number	Service Pipe Schedule	Lateral			
		Horizontal Capacity per Installation Angle from Vertical			
		30° - 44°	45° - 59°	60° - 74°	75° - 90°
CSBQG0250EG	Lightwall	1,410 lb	2,000 lb	2,450 lb	2,740 lb
	10	1,410 lb	2,000 lb	2,450 lb	2,740 lb
	40	1,410 lb	2,000 lb	2,450 lb	2,740 lb
CSBQG0300EG	Lightwall	1,190 lb	1,680 lb	2,060 lb	2,300 lb
	10	1,190 lb	1,680 lb	2,060 lb	2,300 lb
	40	1,190 lb	1,680 lb	2,060 lb	2,300 lb
CSBQG0400EG	Lightwall	1,190 lb	1,680 lb	2,060 lb	2,300 lb
	10	1,190 lb	1,680 lb	2,060 lb	2,300 lb
	40	1,190 lb	1,680 lb	2,060 lb	2,300 lb
CSBQG0600EG	Lightwall	870 lb	1,230 lb	1,510 lb	1,690 lb
	10	870 lb	1,230 lb	1,510 lb	1,690 lb
	40	970 lb	1,370 lb	1,680 lb	1,870 lb
CSBQG0800EG	0.188" (Wall Thickness)	790 lb	1,110 lb	1,360 lb	1,520 lb
	40	790 lb	1,110 lb	1,360 lb	1,520 lb

# RIGID BRACING SYSTEM

## UNIVERSAL STRUCTURAL BRACKET, STRUT BRACE

- Meets requirements of the Buy American Act
- Used for installations where strut brace is perpendicular to structure
- One wrench size fits all required hardware, eliminating the need to change tools
- Shear-off head helps ensure correct torque and simplifies inspection
- Compatible with brace members of 12 GA strut type A



Material: Steel  
Finish: ElectroGalvanized



Part #	Description	
CSBUS1	9/16" Hole	20 pc
CSBUS2	13/16" Hole	20 pc

Cut length for strut member is +/- 1" (25 mm) of measured length.

FM Approved Loads		Horizontal Capacity per Installation Angle from Vertical			
Part Number	Brace Member	30° - 44°	45° - 59°	60° - 74°	75° - 90°
		CSBUS1	12 GA Strut Channel	2,010 lb	2,840 lb
CSBUS2	12 GA Strut Channel	2,010 lb	2,840 lb	3,420 lb	3,810 lb

# RIGID BRACING SYSTEM

## TRAPEZE SWAY BRACE, STRUT

- Meets requirements of the Buy American Act
- Seismically braces trapeze hangers
- Retrofit ability allows for the brace to be installed after the trapeze assembly is installed
- One wrench size fits all required hardware, eliminating the need to change tools
- Shear-off head helps ensure correct torque and simplifies inspection
- FM® Specification Tested
- Compatible with brace members of 12 GA strut type A



Material: Steel  
Finish: Electrogalvanized



Part #	Description	
--------	-------------	---

CSBR2	3/8", 1/2", 5/8", 3/4" Rod	15 pc
-------	----------------------------	-------

Cut length for strut member is +/- 1" (25 mm) of measured length.

FM Specification Tested Loads		Horizontal Capacity per Installation Angle from Vertical			
Part Number	Brace Member	Horizontal Capacity per Installation Angle from Vertical			
		30° - 44°	45° - 59°	60° - 74°	75° - 90°
CSBR2	12 GA Strut Channel	1,051 lb	1,480 lb	1,781 lb	1,987 lb

# RIGID BRACING SYSTEM

## TRAPEZE SWAY BRACE, PIPE

- Meets requirements of the Buy American Act
- Seismically braces trapeze hangers
- Retrofit ability allows for the brace to be installed after the trapeze assembly is installed
- Works with brace members of schedule 40 pipe, EMT conduit, and rigid conduit
- One wrench size fits all required hardware, eliminating the need to change tools
- Shear-off head helps ensure correct torque and simplifies inspection
- FM® Specification Tested



Material: Steel  
Finish: Electrogalvanized



Part #	Description	
CSBR1	3/8", 1/2", 5/8", 3/4" Rod	15 pc

FM Specification Tested Loads					
Part Number	Brace Member	Horizontal Capacity per Installation Angle from Vertical			
		30° - 44°	45° - 59°	60° - 74°	75° - 90°
CSBR1	1" EMT Conduit	623 lb	876 lb	1,055 lb	1,176 lb
	1" Rigid Conduit	623 lb	876 lb	1,055 lb	1,176 lb
	1" - 2" Sch 40 Pipe	755 lb	1,109 lb	1,681 lb	1,875 lb

# RIGID BRACING SYSTEM

## LATERAL TELESCOPING BRACE ASSEMBLY

- Complete, out of the box assembly is compatible with both steel (IPS) and CPVC piping
- Telescoping brace member eliminates the need to cut pipe, minimizing waste and allowing one person to effectively complete the installation
- Easy “push-to-install” nVent CADDY Rod Lock feature allows the V-bolt to assemble quickly, and helps eliminate the risk of compressing CPVC pipe
- Length of telescoping lateral brace is fixed by installing the included self-drilling screw
- Electrogalvanized coating throughout the entire assembly provides superior corrosion resistance, and eliminates the risk of exposing CPVC pipe to any harmful oils or residue
- Designed to reduce the installation time of a complete brace by up to 80%
- Design allows center loading of brace on the service pipe
- Meets requirements of NFPA® 13
- FM® Specification Tested
- Certified chemically compatible with CPVC piping systems
- Meets CEN/TS 17551:2021 requirements for Seismic Sway Bracing



Material: Steel  
Finish: Electrogalvanized



Part #	Description	UL Loads	
CSBT1	1'-1 1/2' Brace Length	680 lbs.	5 pc
CSBT2	1 1/2'-3' Brace Length	680 lbs.	5 pc

UL Listed Load applies to Sch 40, Sch 10, Youngstown Tube Fire-Flo (1-1/2" to 4"), Bull Moose Eddy Flo (1-1/4" to 4"), and Wheatland Mega Flow (1-1/4" to 4") service pipes in the lateral direction.

### Vertical Distance from Structure to Pipe Centerline Based on 45° Brace Angle

Part Number	Pipe Size			
	1"	2"	3"	4"
CSBT1	10" - 13"	10" - 13"	11" - 14"	11" - 14"
CSBT2	12" - 22"	12" - 23"	13" - 23"	13" - 24"

## SELF DRILLING SCREW

- Replacement screw for Lateral Telescoping Brace Assembly



Material: Steel  
Finish: STALGARD®

Part #	Screw Diameter	Screw Length	Wrench Size	
CSBTS1	0.2"	1 1/4"	5/16"	10 pc

## RIGID BRACING SYSTEM

### CONE POINT SHEAR BOLT



Material: Steel  
Finish: Electrogalvanized

Part #	Product	
CSBSB50EG	Steel Flange Adapter, Steel Flange Adapter Assembly, Adjustable I-Beam Adapter	100 pc
CSBUB62EG	Trapeze Sway Brace, Pipe, Universal Structural Bracket, Universal Sway Brace (1" - 12" sizes)	100 pc

### RIVET HEAD SHEAR BOLT

- One wrench size fits all required hardware, eliminating the need to change tools



Material: Steel  
Finish: Electrogalvanized

Part #	Product	
CSBSBR50EG	Strut Seismic Hinge Bracket Assembly, Trapeze Sway Brace, Strut, Universal Structural Bracket, Strut Brace	100 pc

### SHEAR NUT



Material: Steel  
Finish: Electrogalvanized

Part #	Product	
CSBHN50EG	Universal Sway Brace (5"-12" sizes)	100 pc
CSBLN50EG	Universal Sway Brace (1"-4" sizes)	100 pc
CSBQIKCLSN37EG	Quick Grip Jr. Lateral Sway Brace	100 pc
CSBSN37EG	Adjustable I-Beam Adapter, Trapeze Sway Brace, Pipe, Trapeze Sway Brace, Strut	100 pc

## DETERMINING FACTORS IN BRACING

The requirements for seismic protection depend on the building risk category or risk classification as well as the building location. The higher the seismicity of the location and greater the building occupancy, the more stringent the requirements. For example, military or healthcare facilities in a generally seismically-moderate area will typically require some bracing because of the buildings importance to disaster recovery, when an adjacent strip mall may not require it.

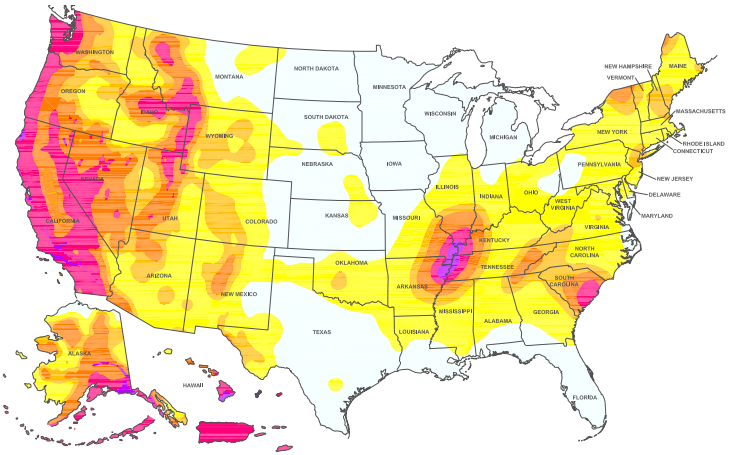

### Risk Category

**Category I:** Low hazard to human life, barns

**Category II:** Residential, strip malls, individual commercial buildings

**Category III:** High occupancy, stadiums, buildings containing hazardous materials

**Category IV:** Hospitals and essential facilities, government buildings

# Seismic Bracing and Vibration Isolation

Earthquakes and similar events pose a direct risk to the ongoing operations of government, businesses, and public operations. To protect against these risks, building and industry codes include requirements for the design and installation of seismic bracing for non-structural components, such as HVAC, fire sprinkler, mechanical, electrical and plumbing systems.

The nVent CADDY Seismic Bracing System was developed to keep these critical building systems operational after a seismic event.

We also offer Vibration Isolation Solutions (such as Spring Hangers, Spring Mounts, Pads, and Expansion Joints) for shock and noise control.

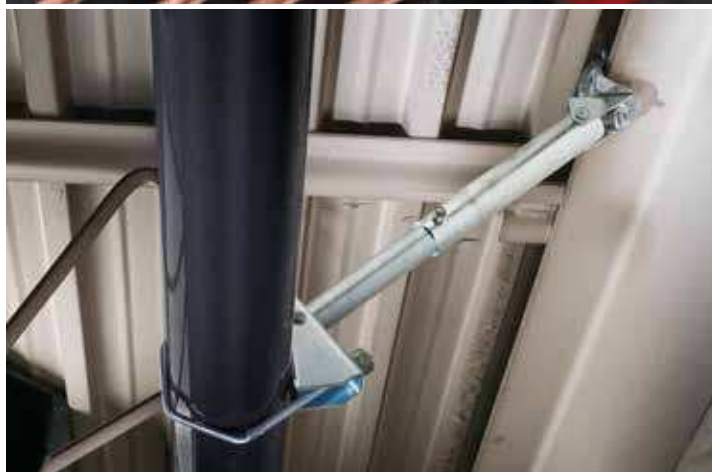



# Cable Bracing System

Cable Bracing System



# CABLE BRACING SYSTEM

## CABLE SPOOL

- Cut to length as needed
- Pre-stretched restraint cable
- Certified chemically compatible with CPVC piping systems
- Meets CEN/TS 17551:2021 requirements for Seismic Sway Bracing



Material: Steel  
Finish: Pregalvanized, Painted



Part #	Description	UL Listed Load	
CSB12CBL	#12 Brace, Red	418 lb	250'
CSB18CBL	#18 Brace, White	772 lb	250'
CSB36CBL	#36 Brace, Blue	1,909 lb	250'



Cable is powder coated.

## CABLE SPOOL, STAINLESS STEEL

- Cut to length as needed
- Pre-stretched restraint cable
- Certified chemically compatible with CPVC piping systems



Material: Stainless Steel 316 (EN 1.4401)  
Static Load Safety Factor: 1.5:1

Part #	Description		
CSB12CBLSS	#12 Brace	317 lb	250'
CSB18CBLSS	#18 Brace	618 lb	250'
CSB36CBLSS	#36 Brace	1,317 lb	250'

# CABLE BRACING SYSTEM

## WIRE ROPE CUTTER

- Designed to reduce cable fraying



Material: Steel

Part #	Description	
CSBC48	#36 Brace, 1/4" Max Cable Diameter	1 pc
SLWC	For brace sizes #12 and #18	1 pc

## OVAL SLEEVE

- Creates secure loop ends
- Swage with swaging tools



Part #	Description	
Material: Copper – Finish: Electrogalvanized		
CSB12SLVB	EG, #12 Brace	5 x 100 pc
CSB18SLVB	EG, #18 Brace	5 x 100 pc
CSB36SLVB	EG, #36 Brace	5 x 50 pc
Material: Stainless Steel 316 (EN 1.4401)		
CSB12SLVBSS	S316, #12 Brace	5 x 100 pc
CSB18SLVBSS	S316, #18 Brace	5 x 100 pc
CSB36SLVBSS	S316, #36 Brace	5 x 50 pc

# CABLE BRACING SYSTEM

## UNIVERSAL RESTRAINT CLIP

- Attaches cable brace to structure
- Meets CEN/TS 17551:2021 requirements for Seismic Sway Bracing



Part #	Description	Cert	
<b>Material: Stainless Steel 316 (EN 1.4401)</b>			
CSBURC38SS	S316, #12, #18, #36 Brace, 7/16" Hole		50 pc
CSBURC12SS	S316, #12, #18, #36 Brace, 9/16" Hole		50 pc
CSBURC58SS	S316, #12, #18, #36 Brace, 11/16" Hole		25 pc
<b>Material: Steel – Finish: Electrogalvanized</b>			
CSBURC38	EG, #12, #18, #36 Brace, 7/16" Hole	UL	50 pc
CSBURC12	EG, #12, #18, #36 Brace, 9/16" Hole	UL	50 pc
CSBURC58	EG, #12, #18, #36 Brace, 11/16" Hole	UL	25 pc
CSBURC34	EG, #12, #18, #36 Brace, 13/16" Hole	UL	25 pc
CSBURC78	EG, #12, #18, #36 Brace, 15/16" Hole	UL	25 pc

Brace member is not included.

Mount to the structure using the center hole. Loop cable through the holes in the bent tabs and swage in place.

UL Loads		
Part Number	Brace Member	Load Rating
CSBURC38	CSB12CBL	418 lb
	CSB18CBL	772 lb
CSBURC12	CSB12CBL	418 lb
	CSB18CBL	772 lb
CSBURC58	CSB12CBL	418 lb
	CSB18CBL	772 lb
CSBURC34	CSB12CBL	418 lb
	CSB18CBL	772 lb
CSBURC78	CSB12CBL	418 lb
	CSB18CBL	772 lb

# CABLE BRACING SYSTEM

## UNIVERSAL RESTRAINT CLIP, SLOTTED

- Slotted design ideal for attaching to existing threaded rod on trapezes
- Meets CEN/TS 17551:2021 requirements for Seismic Sway Bracing



Material: Steel  
Finish: Electrogalvanized



Part #	Description	
CSBURCR38	#12, #18 Brace, 3/8" Rod	50 pc
CSBURCR12	#12, #18 Brace, 1/2" Rod	50 pc
CSBURCR58	#12, #18 Brace, 5/8" Rod	25 pc

Brace member is not included.

UL Loads		
Part Number	Brace Member	Load Rating
CSBURCR38	CSB12CBL	418 lb
	CSB18CBL	772 lb
CSBURCR12	CSB12CBL	418 lb
	CSB18CBL	772 lb
CSBURCR58	CSB12CBL	418 lb
	CSB18CBL	772 lb

## CABLE BRACING SYSTEM

### NO PRY CLIP

- Eliminates prying effect on fasteners and anchors
- Meets CEN/TS 17551:2021 requirements for Seismic Sway Bracing



Material: Steel  
Finish: ElectroGalvanized



Part #	Description	
CSBNPC38	#12, #18, #36 Brace, 7/16" Hole	50 pc
CSBNPC12	#12, #18, #36 Brace, 9/16" Hole	50 pc
CSBNPC58	#12, #18, #36 Brace, 11/16" Hole	50 pc

Brace member is not included.

UL Loads		
Part Number	Brace Member	Load Rating
CSBNPC38	CSB12CBL	418 lb
	CSB18CBL	772 lb
	CSB36CBL	1909 lb
CSBNPC12	CSB12CBL	418 lb
	CSB18CBL	772 lb
	CSB36CBL	1909 lb
CSBNPC58	CSB12CBL	418 lb
	CSB18CBL	772 lb
	CSB36CBL	1909 lb

# CABLE BRACING SYSTEM

## URC ATTACHMENT KIT

- Attaches cable brace to structure
- Two-way bracing kit with oval sleeves
- Wraps around structural steel members



Material: Steel  
Finish: Electrogalvanized, Painted



Part #	Description	UL Listed Load	
<b>Brace Size: #12 – Color: Red</b>			
CSB2W12URC38L10	7/16" Hole, 10' Brace Length	418 lb	1 pc
CSB2W12URC38L20	7/16" Hole, 20' Brace Length	418 lb	1 pc
CSB2W12URC12L10	9/16" Hole, 10' Brace Length	–	1 pc
CSB2W12URC12L20	9/16" Hole, 20' Brace Length	–	1 pc
<b>Brace Size: #18 – Color: White</b>			
CSB2W18URC38L10	7/16" Hole, 10' Brace Length	772 lb	1 pc
CSB2W18URC38L20	7/16" Hole, 20' Brace Length	772 lb	1 pc
CSB2W18URC12L10	9/16" Hole, 10' Brace Length	772 lb	1 pc
CSB2W18URC12L20	9/16" Hole, 20' Brace Length	772 lb	1 pc
<b>Brace Size: #36 – Color: Blue</b>			
CSB2W36URC12L10	9/16" Hole, 10' Brace Length	1,100 lb	1 pc
CSB2W36URC12L20	9/16" Hole, 20' Brace Length	1,100 lb	1 pc
CSB2W36URC58L10	11/16" Hole, 10' Brace Length	–	1 pc
CSB2W36URC58L20	11/16" Hole, 20' Brace Length	–	1 pc

# CABLE BRACING SYSTEM

## MANUAL SWAGING TOOL



Material: Steel

Part #	Description	
CSB12SBHS	#12 Brace	1 pc

## MULTI-SIZE MANUAL SWAGING TOOL



Material: Steel

Part #	Description	
CSB3346SB	#12, #18, #36 Brace	1 pc

## BATTERY-OPERATED SWAGING TOOL

- Battery-operated tool provides consistent swaging
- Provides less strenuous installation when compared to manual swaging tools
- Cordless design allows installers to easily move around the job site
- Compatible with large diameter cables



Material: Steel



Part #	Description	
CSBBS121836	#12, #18, #36 Brace	1 pc



# Branch Line Restraint System



Branch Line Restraint System

## BRANCH LINE RESTRAINT SYSTEM

### BRANCH LINE RESTRAINT PIPE ATTACHMENT

- Accepts 3/8" or 1/2" (M10 or M12) threaded rod
- Quick grip clamp simplifies measuring and cutting of threaded rod
- Eliminates need to cut threaded rod to exact dimensions
- Works with rough-cut threaded rod and eliminates pipe-side deburring
- Can be installed with threaded rod above or below the service pipe
- Shear-off head helps ensure correct torque and simplifies inspection



Branch Line Restraint System

Material: Steel  
Finish: Electrogalvanized



Part #	Description	
CSBBRP0100EG	1" Pipe	50 pc
CSBBRP0125EG	1 1/4" Pipe	50 pc
CSBBRP0150EG	1 1/2" Pipe	25 pc
CSBBRP0200EG	2" Pipe	25 pc

### BRANCH LINE RESTRAINT STRUCTURE ATTACHMENT TO STEEL

- Swivel barrel nut accepts 3/8" or 1/2" (M10 or M12) threaded rod
- Attaches to steel members with self-drilling/tapping screw



Material: Steel  
Finish: Electrogalvanized



Part #	Description	
CSBBRS1EG	3/8", 1/2" Rod	50 pc

Branch line structural attachments are for restraint only and not for the hanging of fire sprinkler piping.

# BRANCH LINE RESTRAINT SYSTEM

## BRANCH LINE RESTRAINT STRUCTURE ATTACHMENT TO WOOD/CONCRETE

- Swivel barrel nut accepts 3/8" or 1/2" (M10 or M12) threaded rod
- Attaches to wood or concrete where cracked concrete approval is not needed



Material: Steel  
Finish: Electrogalvanized



Part #	Description	
CSBBRS2EG	3/8", 1/2" Rod	50 pc

Branch line structural attachments are for restraint only and not for the hanging of fire sprinkler piping.

## BRANCH LINE RESTRAINT STRUCTURE ATTACHMENT TO THREADED HOLE

- Swivel barrel nut accepts 3/8" or 1/2" (M10 or M12) threaded rod
- Attaches to concrete anchors or structural attachments with female threads
- Can be used for bolting through steel



Material: Steel  
Finish: Electrogalvanized



Part #	Description	
CSBBRS3EG	3/8", 1/2" Rod. 3/8" Screw Diameter	50 pc

Branch line structural attachments are for restraint only and not for the hanging of fire sprinkler piping.

The Branch Line Restraint Structure Attachment to Threaded Hole works well with the 3/8" Drop-in Anchor. More information available on page 26-3.



Part #	Description	
CA0037EG	EG, 3/8" Hole, 1.563"	50 pc

Branch Line Restraint System

# Bracing Systems Calculator

Now it's easier than ever to select the correct bracing products for use in fire protection applications. nVent has unveiled the Bracing Systems Calculator, a new web-based calculator which allows users to create and save designs for multiple projects while providing the necessary submittal forms. This time-saving calculator simplifies the selection of products and provides the necessary engineering calculations – providing a complete solution to support rigid bracing, cable bracing and branch line restraints.

## FEATURES

- No installation needed – access via a current web browser
- Offers dynamic design preview and uses visual design tools
- Generates a complete submittal and project materials list
- Create, manage, and re-use designs
- Supports NFPA® 13 including 2013 ed., IBC® and other building codes



Visual Design Tools



Dynamic Design Preview



Materials List

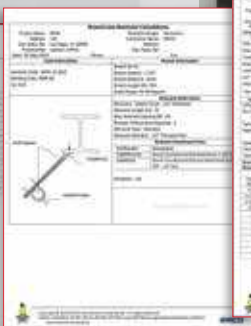

Branch Line Restraint Submittal



Seismic Brace Submittal

nVent is trusted for developing innovative and time-saving products for the fire and sprinkler bracing market. To request access to the Bracing Systems Calculator, contact your local nVent representative or visit [nVent.com/CADDY](http://nVent.com/CADDY)

# Bracing Accessories



Bracing Accessories

## BRACING ACCESSORIES

### STRUT SEISMIC HINGE

- Complete hinge assembly
- Ideal for attaching sway bracing to MEP system supports
- Attaches to strut trapezes and to structure



Material: Steel  
Finish: Electrogalvanized

Part #	Description	
CSBSH00375EG	9/16" Hole 1, 7/16" Hole 2	10 pc
CSBSH00500EG	9/16" Hole 1, 9/16" Hole 2	10 pc
CSBSH00625EG	9/16" Hole 1, 11/16" Hole 2	10 pc
CSBSH00750EG	9/16" Hole 1, 13/16" Hole 2	10 pc

### CLEVIS BOLT SPACER

- Seismically braces the 401 Clevis Hanger series for lateral load
- Retrofit ability allows the spacer to be installed after the clevis and pipe are installed
- Ears easily pinch closed around the clevis hanger cross bolt with pliers
- FM® Specification Tested (up to 8" Pipe Size)



Material: Steel  
Finish: Electrogalvanized

Part #	Description	
CSBCS0100	1" Pipe	100 pc
CSBCS0125	1 1/4" Pipe	100 pc
CSBCS0150	1 1/2" Pipe	100 pc
CSBCS0200	2" Pipe	100 pc
CSBCS0250	2 1/2" Pipe	100 pc
CSBCS0300	3" Pipe	100 pc
CSBCS0350	3 1/2" Pipe	50 pc
CSBCS0400	4" Pipe	50 pc
CSBCS0500	5" Pipe	50 pc
CSBCS0600	6" Pipe	50 pc
CSBCS0800	8" Pipe	25 pc
CSBCS1000	10" Pipe	25 pc
CSBCS1200	12" Pipe	25 pc

# BRACING ACCESSORIES

## PIPE ROD STIFFENER

- For use with Schedule 40 or Schedule 10 pipe
- Secures pipe to threaded rod for stiffening
- For use with EN-10255 H and EN-10255 M pipe



Material: Steel  
Finish: Electrogalvanized

Part #	Description	
CSBRS1	1" Brace Pipe, 3/8", 1/2", 5/8" Rod	10 x 10 pc

## STRUT ROD STIFFENER

- Secures strut channel to threaded rod for stiffening



Material: Steel  
Finish: Electrogalvanized

Part #	Description	
CSBRS37EG	3/8", 1/2", 5/8", 3/4" Rod	25 pc

## NVENT CADDY QUICK CLIP ROD STIFFENER

- Secures strut channel to threaded rod for stiffening
- One hand, snap-in place installation
- No tools or bolt tightening required



Material: Stainless Steel 316 (EN 1.4401)

Part #	Description	
CSBRS2	3/8" Rod	50 pc
CSBRS3	1/2" Rod	50 pc
CSBRS4	5/8" Rod	50 pc

# BRACING ACCESSORIES

## SEISMIC LIGHTING FIXTURE CLAMP

- Secures fluorescent light fixtures to the ceiling frame members
- Requires no additional chains, cables or slack wires attached to the fixture
- Helps strengthen integrity of the T-Grid system
- Holds in place against the force of standard fire-hose pressure
- Meets U.S. building code and electrical code specifications
- Also satisfies NEC® 410.16(C) positive attachment for secure fastening of luminaires (fixtures) complying with Building Code Reference AC184
- Reusable and cost effective

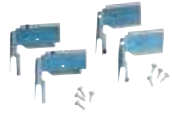

Material: Steel  
Finish: Plain



Bracing Accessories

Part #	Description	
SFCLT	One Standard Tapered 2' x 4' Fixture	25 x 4 pc
SFCLTCF	One 2' x 2' Fixture	50 x 2 pc
SFCLTCFS	Reinforcement of T-Bar Main Runner/Cross Runner Connections	50 x 2 pc
SFCLTE	Two Standard Tapered 2' x 4' Fixtures End-to-End	25 x 2 pc
SFCLTS	Two Standard Tapered 2' x 4' Fixtures Side-by-Side	25 x 2 pc

Tested for compliance to the UBC, NEC®, NBC, and CEC.



# Hardware



Hardware



# HARDWARE

## THREADED ROD

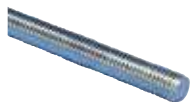
- Cut to length as needed



Material: Steel  
Finish: Electrogalvanized  
Tensile Strength: 58,000 psi  
Yield Strength: 36,000 psi

Part #	Description		
0502506EG	EG, 1/4" Rod, 6'	240 lb	6'
0502510EG	EG, 1/4" Rod, 10'	240 lb	10'
0503706EG	EG, 3/8" Rod, 6'	600 lb	6'
0503710EG	EG, 3/8" Rod, 10'	610 lb	10'
0503712EG	EG, 3/8" Rod, 12'	600 lb	12'
0505006EG	EG, 1/2" Rod, 6'	1,130 lb	6'
0505010EG	EG, 1/2" Rod, 10'	1,130 lb	10'
0505012EG	EG, 1/2" Rod, 12'	1,130 lb	12'
0506206EG	EG, 5/8" Rod, 6'	1,810 lb	6'
0506210EG	EG, 5/8" Rod, 10'	1,810 lb	10'
0506212EG	EG, 5/8" Rod, 12'	1,810 lb	12'
0507506EG	EG, 3/4" Rod, 6'	2,710 lb	6'
0507510EG	EG, 3/4" Rod, 10'	2,710 lb	10'
0507512EG	EG, 3/4" Rod, 12'	2,710 lb	12'
0508706EG	EG, 7/8" Rod, 6'	3,770 lb	6'
0508710EG	EG, 7/8" Rod, 10'	3,770 lb	10'



Load based on Max. 650 degrees F.

## THREADED STUD

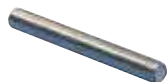
- Pre-cut lengths of threaded rod



Material: Steel  
Finish: Plain  
Tensile Strength: 58,000 psi  
Yield Strength: 36,000 psi

Part #	Description		
0513702PL	3/8" Rod, 2"	600 lb	100 pc

# HARDWARE

## EM-HEX ROD COUPLER



Material: Steel  
Finish: Electrogalvanized

Part #	Description	F ↓	☐
0250025EG	1/4" Rod	240 lb	100 pc
0250037EG	3/8" Rod	600 lb	100 pc
0250050EG	1/2" Rod	1,130 lb	100 pc
0250062EG	5/8" Rod	1,810 lb	100 pc
0250075EG	3/4" Rod	2,710 lb	100 pc
0250087EG	7/8" Rod	3,770 lb	50 pc

## 25R HEX ROD REDUCER

- Threaded rod reducing coupling



Material: Steel  
Finish: Electrogalvanized

Part #	Description	F ↓	☐
025R3725EG	3/8" Rod 1, 1/4" Rod 2	240 lb	100 pc
025R5037EG	1/2" Rod 1, 3/8" Rod 2	600 lb	100 pc
025R6250EG	5/8" Rod 1, 1/2" Rod 2	1,130 lb	100 pc

Never use smaller rod sizes than the minimum rod sizes defined by applicable code.

## HARDWARE

### 26 BEAM CLAMP EXTENSION PIECE

- Accessory that may attach to the side of a structural member or to a beam clamp
- Extension may be used in conjunction with Model #360



Material: Steel  
Finish: Plain

Part #	Description	F ↓	☐
0260037PL	3/8" Rod	600 lb	100 pc
0260050PL	1/2" Rod	1,130 lb	100 pc
0260062PL	5/8" Rod	1,550 lb	50 pc
0260075PL	3/4" Rod	2,100 lb	50 pc

### 35 HEAVY DUTY EYE NUT

- Accessory for high temperature piping used in conjunction with 320L and 320W Weld Beam Attachments and the 360 Malleable Iron Adjustable Center Load Beam Clamps
- Conforms with Federal Specification WW-H-171 (Type 17), Manufacturers Standardization Society MSS-SP-58 (Type 17)



Material: Steel  
Finish: Plain

Part #	Description	F ↓	☐
0350037PL	3/8" Rod	1,250 lb	50 pc

Install in accordance with applicable code.

# HARDWARE

## 47 EYE NUT

- Attachment for various types of pipe supports and structural attachments
- Conforms with Federal Specification WW-H-171 (Type 16), Manufacturers Standardization Society MSS-SP-58 (Type 16)



Material: Steel  
Finish: Plain

Part #	Description	F ↓	↓
0470025PL	1/4" Rod	230 lb	100 pc
0470037PL	3/8" Rod	600 lb	100 pc
0470050PL	1/2" Rod	1,130 lb	100 pc

Install in accordance with applicable code.

## SWFF SWIVEL FEMALE-FEMALE

- Attachment with the capability to swivel



Material: Steel  
Finish: Electrogalvanized

Part #	Description	F ↓	↓
SWFF0037EG	3/8" Rod	1,000 lb	50 pc
SWFF0050EG	1/2" Rod	1,800 lb	50 pc

## SWMF SWIVEL MALE-FEMALE

- Attachment with the capability to swivel



Material: Steel  
Finish: Electrogalvanized

Part #	Description	F ↓	↓
SWMF0037EG	3/8" Rod	1,000 lb	50 pc
SWMF0050EG	1/2" Rod	1,800 lb	50 pc

# HARDWARE

## FIXTURE SUPPORT FROM PLAIN ROD/WIRE

- No tools required for installation
- Eliminates the use of nut and allows the use of plain rod



Material: Spring Steel  
Finish: nVent CADDY Armour

Part #	Description	
2EBN	#8 Wire	100 pc
4EBN	1/4" Rod	100 pc



## THREADED ROD HANGER FROM BAR JOIST

- Fits open web joists with round bottom chords
- Permits accurate centering



Material: Spring Steel  
Finish: nVent CADDY Armour



Part #	Description		
4TW	1/4" Rod, Threaded	100 lb	100 pc
6W	3/8" Rod, Plain	200 lb	100 pc

# HARDWARE

## 41 COACH SCREW

- Light duty hanger rod for wood structures



Material: Steel  
Finish: Plain

Part #	Description	F ↓	☐
0413704PL	3/8" Rod, 4"	390 lb	100 pc
0413706PL	3/8" Rod, 6"	390 lb	100 pc
0413708PL	3/8" Rod, 8"	390 lb	100 pc
0413710PL	3/8" Rod, 10"	390 lb	100 pc
0415004PL	1/2" Rod, 4"	640 lb	100 pc
0415006PL	1/2" Rod, 6"	640 lb	100 pc
0415008PL	1/2" Rod, 8"	640 lb	100 pc

## 42 HEX HEAD LAG SCREW

- For use with wood structures



Material: Steel  
Finish: Electrogalvanized

Part #	Description	☐
0422515EG	1/4" Screw, 1 1/2" Screw	100 pc
0422520EG	1/4" Screw, 2" Screw	100 pc
0423715EG	3/8" Screw, 1 1/2" Screw	100 pc
0423720EG	3/8" Screw, 2" Screw	100 pc
0423725EG	3/8" Screw, 2 1/2" Screw	100 pc
0423730EG	3/8" Screw, 3" Screw	50 pc
0425020EG	1/2" Screw, 2" Screw	50 pc
0425025EG	1/2" Screw, 2 1/2" Screw	50 pc
0425030EG	1/2" Screw, 3" Screw	50 pc

## HARDWARE

### 43 WOOD DRIVE SCREW

- Light duty fastener for mounting various structural attachments onto wood



Material: Steel  
Finish: Electrogalvanized

Part #	Description	
0431602EG	#16 Screw, 2" Screw	100 pc

Install only in shear, never use under pull-out configuration.

### A33 SCREW

- Long indented hex washer head, self tapping screw with pierce point



Material: Steel  
Finish: Electrogalvanized

Part #	Description	
A3308AP100	#10 Screw, 1" Screw	100 pc

Hardware

### COMBI DOME SCREW

- Cross recess combi screw for use with both Slot and Phillips driver



Material: Steel  
Finish: Black Oxide

Part #	Description	
S3575BP100	1/4" Screw, 3/8" Screw	100 pc
S3575BP50	1/4" Screw, 3/8" Screw	50 pc
S3575DP100	1/4" Screw, 3/4" Screw	100 pc



# HARDWARE

## FLAT HEAD CARRIAGE BOLT



Material: Steel  
Finish: Electrogalvanized

Part #	Description	
S31199P100	1/4" Screw, 9/16" Screw	100 pc
S311924P100	1/4" Screw, 1 1/2" Screw	100 pc

## HEX HEAD BOLT

• Fully threaded hexagon head bolt



Material: Steel  
Finish: Electrogalvanized

Part #	Description	
HSCR3710EG	EG, 3/8" Screw, 1" Screw	100 pc
HSCR3712EG	EG, 3/8" Screw, 1.25" Screw	100 pc
HSCR3715EG	EG, 3/8" Screw, 1.5" Screw	100 pc
HSCR3720EG	EG, 3/8" Screw, 2" Screw	100 pc
HSCR5010EG	EG, 1/2" Screw, 1" Screw	100 pc
HSCR5012EG	EG, 1/2" Screw, 1.25" Screw	100 pc
HSCR5015EG	EG, 1/2" Screw, 1.5" Screw	100 pc

Hardware

# HARDWARE

## HEX NUT

- Internally threaded with a hex drive for many applications

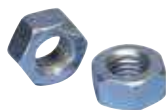

Material: Steel

Part #	Description	
Finish: Electrogalvanized		
0100025EG	EG, 1/4" Rod	100 pc
0100037EG	EG, 3/8" Rod	1,000 pc
0100050EG	EG, 1/2" Rod	1,000 pc
0100062EG	EG, 5/8" Rod	50 pc
0100075EG	EG, 3/4" Rod	50 pc
0100087EG	EG, 7/8" Rod	25 pc
Finish: Plain		
0100025PL	1/4" Rod	100 pc
0100037PL	3/8" Rod	100 pc
0100050PL	1/2" Rod	100 pc
0100062PL	5/8" Rod	50 pc
0100075PL	3/4" Rod	50 pc

Hardware

## HEAVY DUTY HEX NUT

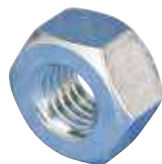

Material: Steel  
Finish: Electrogalvanized

Part #	Description	
010H0037EG	EG, 3/8" Rod	1,000 pc
010H0050EG	EG, 1/2" Rod	1,000 pc
010H0062EG	EG, 5/8" Rod	50 pc
010H0075EG	EG, 3/4" Rod	50 pc
010H0087EG	EG, 7/8" Rod	25 pc

# HARDWARE

## FLAT WASHER

- Use under the head of a bolt or nut in order to distribute the fastener load over a wider surface area



Material: Steel

Part #	Description	
Finish: Electrogalvanized		
0110025EG	EG, 0.313" Hole	100 pc
0110037EG	EG, 0.438" Hole	1,000 pc
0110050EG	EG, 0.563" Hole	1,000 pc
0110062EG	EG, 0.688" Hole	500 pc
0110075EG	EG, 0.813" Hole	50 pc
0110087EG	EG, 0.938" Hole	25 pc
Finish: Plain		
0110025PL	0.313" Hole	100 pc
0110037PL	0.438" Hole	100 pc
0110050PL	0.563" Hole	100 pc
0110062PL	0.688" Hole	50 pc
0110075PL	0.813" Hole	50 pc

## LARGE WASHER



Material: Steel  
Finish: Electrogalvanized

Part #	Description	
0120025EG	0.313" Hole, 1.063" dia	100 pc
0120037EG	0.438" Hole, 1.5" dia	100 pc
0120050EG	0.563" Hole, 2" dia	100 pc

## HARDWARE

### 740 PIPE SLEEVE POSITIONER

- Used to position pipe sleeves and prevent movement during concrete pours
- Requires only a hammer to install
- Can be used for Schedule 40 pipe with sleeve diameter of 2" through 6"
- Can be used for wall thicknesses of 5/16" and under with all sleeve diameters



Material: Spring Steel

Finish: nVent CADDY Armour

Part #	Description	
740	740 Pipe Sleeve Positioner	100 pc

No load rating, for positioning only. For pipe sizes 6" to 14" use 4H Hammer-On Flange Clip, Side Mount

# Anchors



Anchors

## ANCHORS

### WEDGE EXPANSION ANCHOR BOLT

- ICC® approved for use in cracked and uncracked concrete
- Includes nut and washer
- Meets NFPA® 13 as pre-qualified for seismic applications



Material: Steel  
Finish: Electrogalvanized

Part #	Description	
CSBCAB030037EG	3/8" Screw, 3"	50 pc
CSBCAB037550EG	1/2" Screw, 3 3/4"	50 pc
CSBCAB045050EG	1/2" Screw, 4 1/2"	50 pc
CSBCAB055050EG	1/2" Screw, 5 1/2"	25 pc
CSBCAB047562EG	5/8" Screw, 4 3/4"	25 pc
CSBCAB060062EG	5/8" Screw, 6"	25 pc
CSBCAB055075EG	3/4" Screw, 5 1/2"	20 pc
CSBCAB062575EG	3/4" Screw, 6 1/4"	20 pc

### CONCRETE ANCHOR SCREW

- For use with screw drill bits
- ICC® approved for use in cracked and uncracked concrete
- Meets NFPA® 13 as pre-qualified for seismic applications



Material: Steel  
Finish: Electrogalvanized

Part #	Description	
CSBCAS025037EG	3/8" Screw, 2 1/2" Screw, 3/8" Drill Bit Diameter	50 pc
CSBCAS030050EG	1/2" Screw, 3" Screw, 1/2" Drill Bit Diameter	50 pc
CSBCAS040050EG	1/2" Screw, 4" Screw, 1/2" Drill Bit Diameter	50 pc
CSBCAS050050EG	1/2" Screw, 5" Screw, 1/2" Drill Bit Diameter	25 pc
CSBCAS040062EG	5/8" Screw, 4" Screw, 5/8" Drill Bit Diameter	25 pc
CSBCAS050062EG	5/8" Screw, 5" Screw, 5/8" Drill Bit Diameter	25 pc
CSBCAS050075EG	3/4" Screw, 5" Screw, 3/4" Drill Bit Diameter	20 pc

# ANCHORS

## DROP-IN ANCHOR

- Internal thread provides easy removal and serviceability
- Installs flush or below the base surface
- Fire resistance class R30-R120 for design of anchorages under exposure to fire



Material: Steel  
Finish: Electrogalvanized

Part #	Description	
CA0025EG	EG, 1/4" Hole, 1"	100 pc
CA0037EG	EG, 3/8" Hole, 1.563"	50 pc
CA0050EG	EG, 1/2" Hole, 2"	50 pc

The maximum load per fixing point for multiple use for non-structural applications may, depending on national regulations, be below the approved load of the anchor. The approved loads per fixing point are regulated for their respective countries in the ETAG 001, Part 6. Total safety factor as per ETAG 001 included (Ym and Yf).

## FLANGED DROP-IN ANCHOR

- Internal thread provides easy removal and serviceability
- Installs flush for standard embedment
- Fire resistance class R30-R120 for design of anchorages under exposure to fire
- Lip makes the flush installation easier by helping achieve consistent anchor depth and easy threaded rod alignment



Material: Steel  
Finish: Electrogalvanized

Part #	Description	
LA0025EG	1/4" Hole	100 pc
LA0037EG	3/8" Hole	50 pc
LA0050EG	1/2" Hole	50 pc

The maximum load per fixing point for multiple use for non-structural applications may, depending on national regulations, be below the approved load of the anchor. The approved loads per fixing point are regulated for their respective countries in the ETAG 001, Part 6. Total safety factor as per ETAG 001 included (Ym and Yf).

## ANCHORS

### SPIKE ANCHOR

- Use in concrete with threaded rod
- Vibration resistant
- Pre-expanded anchor design allows for easy installation
- Mushroom and flat head spike anchors are tamper-proof
- Removable forming spike can be used for temporary installations
- Pipe spike is an easy to install alternative to direct fastening



Material: Steel  
Finish: Electrogalvanized



Part #	Description	
RAWL3758	3/8" Rod, 1/4" Drill Bit Diameter	50 pc

### HANGERMATE® VERTICAL MOUNT SCREW FOR STEEL

- Convenient design allows fast and easy installation
- Eliminates the need for labor-intensive operations, such as pre-punching or drilling of steel components
- Only one driver needed for all anchor sizes
- Tapped head permits in-line mounting of threaded rod systems



Material: Steel  
Finish: Electrogalvanized

Part #	Description	
HMZG160	1/4" Rod, 0.06"-0.25" Flange	50 pc
HMZG470	3/8" Rod, 0.06"-0.25" Flange	50 pc



# ANCHORS

## HANGERMATE® VERTICAL MOUNT SCREW FOR STEEL WITH LOCK NUT

- Convenient design allows fast and easy installation
- Eliminates the need for labor-intensive operations, such as pre-punching or drilling of steel components
- Only one driver needed for all anchor sizes
- Tapped head permits in-line mounting of threaded rod systems



Material: Steel  
Finish: Electrogalvanized

Part #	Description	
HMZG471	3/8" Rod, 0.06"–0.25" Flange	50 pc

## HANGERMATE® HORIZONTAL MOUNT SCREW FOR STEEL

- Convenient design allows fast and easy installation
- Eliminates the need for labor-intensive operations, such as pre-punching or drilling of steel components
- Only one driver needed for all anchor sizes
- Cross-drilled and tapped head permits horizontal mounting of threaded rod systems



Material: Steel  
Finish: Electrogalvanized

Part #	Description	
HMZH475	3/8" Rod, 0.06"–0.25" Flange	50 pc

## HANGERMATE® HORIZONTAL MOUNT SCREW FOR STEEL WITH LOCK NUT

- Convenient design allows fast and easy installation
- Eliminates the need for labor-intensive operations, such as pre-punching or drilling of steel components
- Only one driver needed for all anchor sizes
- Cross-drilled and tapped head permits horizontal mounting of threaded rod systems



Material: Steel  
Finish: Electrogalvanized

Part #	Description	
HMZH476	3/8" Rod, 0.06"–0.25" Flange	50 pc

## ANCHORS

### HANGERMATE® VERTICAL MOUNT SCREW FOR WOOD

- Convenient design allows fast and easy installation
- Only one driver needed for all anchor sizes
- Tapped head permits in-line mounting of threaded rod systems



Material: Steel  
Finish: Electrogalvanized

Part #	Description	
HMZG315	1/4" Rod, 5/16" Screw, 2 1/4" Screw	50 pc
HMZG650	3/8" Rod, 5/16" Screw, 2 1/4" Screw	50 pc

### HANGERMATE® HORIZONTAL MOUNT SCREW FOR WOOD

- Convenient design allows fast and easy installation
- Only one driver needed for all anchor sizes
- Cross-drilled and tapped head permits horizontal mounting of threaded rod systems



Material: Steel  
Finish: Electrogalvanized

Part #	Description	
HMZH665	3/8" Rod, 5/16" Screw, 2 1/4" Screw	50 pc

# ANCHORS

## HANGERMATE® VERTICAL MOUNT SCREW FOR CONCRETE

- End-drilled and tapped for attaching threaded components to concrete
- Solid, one piece cold formed part; head cannot spin off or unscrew from body
- Tapered threads allow for easy starting in pre-drilled hole



Material: Steel  
Finish: Electrogalvanized

Part #	Description	F ↓	☐
HMZG365	1/4" Rod, 5/16" Screw, 2 1/4" Screw	2,188 lb	50 pc
HMZG730	3/8" Rod, 5/16" Screw, 2 1/4" Screw	2,188 lb	50 pc

Tested in 3650 psi concrete. Appropriate safety factors should be applied for design purposes.

## HANGERMATE® HEX DRIVE SOCKET

- Installs anchors quickly and easily
- Automatically disengages when anchor is seated



Material: Steel  
Finish: Electrogalvanized

Part #	Description	☐
HMZE215	HangerMate Hex Drive Socket	1 pc

## HANGERMATE® SDS DRILL BIT FOR HAMMER DRILLS

- Engineered for accurate drilling in concrete applications



Material: Steel  
Finish: Plain

Part #	Description	☐
HMZE350	1/4" Drill Bit Diameter	1 pc

# ANCHORS

## 145 SPRING TOGGLE

- Used with threaded rod in hollow wall applications



Material: Steel  
Finish: Electrogalvanized

Part #	Description	
1450037EG	3/8" Rod	100 pc
1450050EG	1/2" Rod	50 pc

# nVent CADDY Eristrut



nVent CADDY Eristrut

# NVENT CADDY ERISTRUT

## TELESCOPING STRUT REPLACEMENT

- Captive threaded nuts enable fastening to threaded rod supports without loose parts
- Telescopes to the desired length and is locked in place by snapping closed a spring retainer clip
- Standard strut profile runs the entire length of the part, allowing most standard fittings to be placed anywhere between the rods
- Integrated ruler displays space between hanger rods in inches and centimeters
- Supports up to seven 2" (50 DN) conduits, six 2" (50 DN) water filled pipes at 10' (3 m) spacing, or up to 18" (450 mm) cable tray
- Conduit can be supported on the top and bottom, eliminating the need for double sided strut
- Conduit and pipe can be placed directly on the strut profile, saving vertical space in buildings with limited room for installation
- Meets requirements of the Buy American Act



**Innovative Solution**

Material: Steel  
Finish: Pregalvanized

Part #	Description	F1	F2	Icon
TSR122025	1/4" Rod	300 lb	200 lb	20 pc
TSR1220	3/8" Rod	300 lb	200 lb	20 pc

Static Load 1 represents a distributed load for 12" - 20" (300 - 500 mm) installations and a point load for 12" - 16" (300 - 400 mm) installations. Static Load 2 represents a point load for 16" - 20" (400 - 500 mm) installations.



### Telescoping Strut Replacement with CADDY Rod Lock "push-to-install" technology is featured on page 8-13 & 27-5.

- Easy "push-to-install" design allows installers to simply push the threaded rod through the mounting hole, instantly holding it in position
- Telescopes to the desired length and is locked in place by snapping closed a spring retainer clip
- Standard strut profile runs the entire length of the part, allowing most standard fittings to be placed anywhere between the rods
- Allows installers to prefabricate complex assemblies and quickly lift and lock them into place
- Lock nut can be finger tightened, locking the rod in place

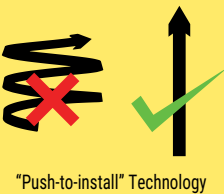

"Push-to-install" Technology

# NVENT CADDY ERISTRUT

## TELESCOPING STRUT REPLACEMENT, NO NUT

- Can be attached directly to a wall for wall-mounted applications
- Telescopes to the desired length and is locked in place by snapping closed a spring retainer clip
- Standard strut profile runs the entire length of the part, allowing most standard fittings to be placed anywhere between the rods
- Integrated ruler displays space between hanger rods in inches and centimeters
- Supports up to seven 2" (50 DN) conduits, six 2" (50 DN) water filled pipes at 10' (3 m) spacing, or up to 18" (450 mm) cable tray
- Conduit can be supported on the top and bottom, eliminating the need for double sided strut
- Conduit and pipe can be placed directly on the strut profile, saving vertical space in buildings with limited room for installation
- Meets requirements of the Buy American Act



**Innovative  
Solution**

Material: Steel

Finish: Pregalvanized

Part #	Description			
TSR1220N	No Nut	300 lb	200 lb	25 pc

Static Load 1 represents a distributed load for 12" - 20" (300 - 500 mm) installations and a point load for 12" - 16" (300 - 400 mm) installations. Static Load 2 represents a point load for 16" - 20" (400 - 500 mm) installations.



# NVENT CADDY ERISTRUT

## TELESCOPING STRUT REPLACEMENT, RETROFIT

- Slotted ends allow the bracket to be installed with four nVent CADDY SN Nuts on threaded rod above an existing trapeze, saving contractor time and limiting building downtime
- Telescopes to the desired length and is locked in place by snapping closed a spring retainer clip
- Standard strut profile runs the entire length of the part, allowing most standard fittings to be placed anywhere between the rods
- Integrated ruler displays space between hanger rods in inches and centimeters
- Supports up to seven 2" (50 DN) conduits, six 2" (50 DN) water filled pipes at 10' (3 m) spacing, or up to 18" (450 mm) cable tray
- Conduit can be supported on the top and bottom, eliminating the need for double sided strut
- Conduit and pipe can be placed directly on the strut profile, saving vertical space in buildings with limited room for installation
- Winner of the EC&M 2017 Product of the Year Platinum Award
- Meets requirements of the Buy American Act



**Innovative  
Solution**

Material: Steel  
Finish: Pregalvanized

Part #	Description			
TSR1220R	3/8" Rod	300 lb	200 lb	25 pc

Static Load 1 represents a distributed load for 12" - 20" (300 - 500 mm) installations and a point load for 12" - 16" (300 - 400 mm) installations. Static Load 2 represents a point load for 16" - 20" (400 - 500 mm) installations.



# NVENT CADDY ERISTRUT

## **NVENT CADDY ROD LOCK TELESCOPING STRUT REPLACEMENT**

- Easy “push-to-install” design allows installers to simply push the threaded rod through the mounting hole, instantly holding it in position
- Telescopes to the desired length and is locked in place by snapping closed a spring retainer clip
- Standard strut profile runs the entire length of the part, allowing most standard fittings to be placed anywhere between the rods
- Allows installers to prefabricate complex assemblies and quickly lift and lock them into place
- Lock nut can be finger tightened, locking the rod in place
- Allows for the quick creation, installation, and adjustment of multi-level trapeze assemblies
- Captive threaded nuts enable fastening to threaded rod supports without loose parts
- Integrated ruler displays space between hanger rods in inches and centimeters
- Supports up to seven 2” (50 DN) conduits, six 2” (50 DN) water filled pipes at 10’ (3 m) spacing, or up to 18” (450 mm) cable tray
- Conduit can be supported on the top and bottom, eliminating the need for double sided strut
- Conduit and pipe can be placed directly on the strut profile, saving vertical space in buildings with limited room for installation
- Meets requirements of the Buy American Act



**Innovative  
Solution**

Material: Steel  
Finish: Pregalvanized

Part #	Description			
TSR122038RL	3/8" Rod	300 lb	200 lb	20 pc

Static Load 1 represents a distributed load for 12" - 20" (300 - 500 mm) installations and a point load for 12" - 16" (300 - 400 mm) installations. Static Load 2 represents a point load for 16" - 20" (400 - 500 mm) installations.

# NVENT CADDY ERISTRUT

## NVENT CADDY SPEED LINK SLS TRAPEZE KIT

- Out of the box trapeze solution includes Telescoping Strut Replacement, wire rope with pre-assembled hook end-fitting, and two nVent CADDY Speed Link SLS locking devices
- Telescopes to the desired length and is locked in place by snapping closed a spring retainer clip
- Standard strut profile runs the entire length of the Telescoping Strut Replacement, allowing most standard fittings to be placed anywhere between the wire rope supports
- Supports up to seven 2" (50 DN) conduits, six 2" (50 DN) water filled pipes at 10' (3 m) spacing, or up to 18" (450 mm) cable tray
- Conduit and pipe can be placed directly on the strut profile, saving vertical space in buildings with limited room for installation
- Fastens to the building structure or hanging services by looping around and hooking to wire rope
- Hooks to a wide range of nVent CADDY fasteners
- Finger tightening of nut secures the locking device into position without tools
- Installs in telescoping strut replacement without the need to insert fingers or tools into the channel
- Easy to remove for applications requiring maintenance



Material: Steel, Zinc Alloy, Polyamide  
Finish: Electrogalvanized, Pregalvanized  
Wire Rope Diameter: 3 mm

Part #	Description	
TSR1220SLS3	nVent CADDY Speed Link SLS Trapeze Kit	10 pc

Static Load 1 represents a distributed load for 12" - 20" (300 - 500 mm) installations and a point load for 12" - 16" (300 - 400 mm) installations. Static Load 2 represents a point load for 16" - 20" (400 - 500 mm) installations.

# NVENT CADDY ERISTRUT

## STRUT CHANNEL TYPE A, SLOTTED

- Cold formed channel, slotted
- Strut channels for heavy applications
- For individual fastening or for efficiently constructing pipe or tube routes

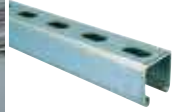

Part #	Description	
Material: Stainless Steel 304 (EN 1.4301)		
A12H1000S4	S304, 10' x 1.625" x 1.625" x 12 GA	10'
Material: Steel – Finish: Hot-Dip Galvanized		
A12H1000HD	HD, 10' x 1.625" x 1.625" x 12 GA	10'
A12H2000HD	HD, 20' x 1.625" x 1.625" x 12 GA	20'
Material: Steel – Finish: PaintedColor – Green:		
A12H1000GN	10' x 1.625" x 1.625" x 12 GA	500'
A14H1000GN	10' x 1.625" x 1.625" x 14 GA	500'
A12H2000GN	20' x 1.625" x 1.625" x 12 GA	500'
A14H2000GN	20' x 1.625" x 1.625" x 14 GA	500'
Material: Steel – Finish: Pregalvanized		
A12H1000PG	PG, 10' x 1.625" x 1.625" x 12 GA	500'
A14H1000PG	PG, 10' x 1.625" x 1.625" x 14 GA	500'
A12H2000PG	PG, 20' x 1.625" x 1.625" x 12 GA	500'
A14H2000PG	PG, 20' x 1.625" x 1.625" x 14 GA	500'

## STRUT CHANNEL TYPE A, SOLID

- Cold formed channel, solid
- Strut channels for heavy applications
- For individual fastening or for efficiently constructing pipe or tube routes

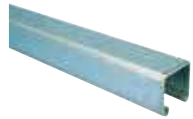

Material: Steel  
Finish: Pregalvanized

Part #	Description	
A121000PG	PG, 10' x 1.625" x 1.625"	10'
A141000PG	PG, 10' x 1.625" x 1.625"	10'

## NVENT CADDY ERISTRUT

### STRUT CHANNEL TYPE AA, SLOTTED

- Cold formed channel, slotted
- Welded back to back
- Strut channels for heavy applications
- For individual fastening or for efficiently constructing pipe or tube routes



Material: Steel

Part #	Description	
Finish: Painted – Color: Green		
A12AH200GN	20' x 3.25" x 1.625" x 12 GA	20'
Finish: Pregalvanized		
A12AH100PG	PG, 10" x 3.25" x 1.625" x 12 GA	10'
A12AH200PG	PG, 20' x 3.25" x 1.625" x 12 GA	20'

### STRUT CHANNEL TYPE C, SLOTTED

- Cold formed channel, slotted
- Strut channels for medium to heavy applications
- For individual fastening or for efficiently constructing pipe or tube routes



Part #	Description	
Material: Stainless Steel 304 (EN 1.4301)		
C14H1000S4	S304, 10' x 13/16" x 1 5/8" x 14 GA	10'
Material: Steel – Finish: PaintedColor – Green:		
C12H1000GN	10' x 13/16" x 1 5/8" x 12 GA	10'
C14H1000GN	10' x 13/16" x 1 5/8" x 14 GA	10'
C12H2000GN	20' x 13/16" x 1 5/8" x 12 GA	20'
C14H2000GN	20' x 13/16" x 1 5/8" x 14 GA	20'
Material: Steel – Finish: Pregalvanized		
C12H1000PG	PG, 10' x 13/16" x 1 5/8" x 12 GA	10'
C14H1000PG	PG, 10' x 13/16" x 1 5/8" x 14 GA	10'
C12H2000PG	PG, 20' x 13/16" x 1 5/8" x 12 GA	20'
C14H2000PG	PG, 20' x 13/16" x 1 5/8" x 14 GA	20'

# NVENT CADDY ERISTRUT

## STRUT CHANNEL TYPE C, SOLID

- Cold formed channel, solid
- Strut channels for medium to heavy applications
- For individual fastening or for efficiently constructing pipe or tube routes

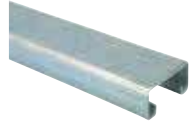

Material: Steel  
Finish: Pregalvanized

Part #	Description	
C121000PG	PG, 10" x 12 GA	500 pc
C141000PG	PG, 10" x 14 GA	500 pc

## STRUT CHANNEL TYPE D, SLOTTED

- Cold formed channel, slotted



Material: Steel  
Finish: Pregalvanized

Part #	Description	
D12H1000PG	PG, 10' x 2.438" x 1.625"	10'
D12H2000PG	PG, 20' x 2.438" x 1.625"	20'

## NVENT CADDY ERISTRUT

### STRUT CHANNEL TYPE D, SOLID

- Cold formed channel, solid
- Strut channels for heavy applications
- For individual fastening or for efficiently constructing pipe or tube routes



Material: Steel  
Finish: Pregalvanized

Part #	Description	
D121000PG	2 7/16" x 1 5/8"	100 pc

### STRUT CHANNEL TYPE E, SLOTTED

- Cold formed channel, slotted



Material: Steel  
Finish: Pregalvanized

Part #	Description	Cert	
E12H1000PG	PG, 10' x 3.25" x 1.625" x 12 GA	ITB	10'
E12H2000PG	PG, 20' x 3.25" x 1.625" x 12 GA		20'

### STRUT CHANNEL TYPE E, SOLID

- Cold formed channel, solid
- Strut channels for heavy applications
- For individual fastening or for efficiently constructing pipe or tube routes



Material: Steel  
Finish: Pregalvanized

Part #	Description	
E121000PG	PG, 10" x 3.25" x 12 GA x 1.625"	100 pc

# NVENT CADDY ERISTRUT

## STRUT CHANNEL CONCRETE INSERT

- Cold formed, with anchor legs
- Polystyrene filler prevents concrete from entering in the channel
- Complete with end caps

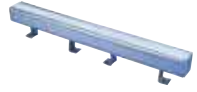

Material: Steel  
Finish: Pregalvanized

Part #	Description	
CONB122000PG	1 5/8" x 12 GA	20'

## STRUT TO STRUT CONNECTOR

- Consists of two halve castings, nut and bolt
- Allows for bolting two strut channels back to back through the slots



Material: Steel  
Finish: Electrogalvanized

Part #	Description		
STS	Strut to Strut Connector	1,000 lb	100 pc

Minimum of 2 required. Maximum spacing 1 foot (300mm). Minimum half-slot dimensions 9/16" x 7/8" (14.3 mm x 22.2 mm).

## ADK STRUT END CAP

- Fits into ERISTRUT Type A channel
- When separated, provides two end caps for ERISTRUT Type C channel



Material: Polyethylene

Part #	Description	
ADK421	Strut End Cap, Blue	100 pc
ADK421GN	Green	100 pc
ADK421GY	Gray	100 pc
ADK421RD	Red	100 pc

## NVENT CADDY ERISTRUT

### ENDC STRUT END CAP

- Fits into ERISTRUT Type A channel

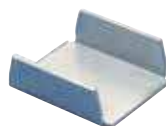

Material: Steel  
Finish: Electrogalvanized

Part #	Description	
ENDCA120EG	ENDC Strut End Cap	100 pc

### STRUT CHANNEL COVER

- Easily snaps into any ERISTRUT strut channel





Part #	Description	
Material: Polystyrene		
CL100000PS	Polystyrene	10'
Material: Steel – Finish: Electrogalvanized		
CL100000EG	EG	10'

### NVENT CADDY SLICK NUT

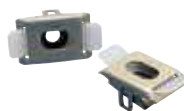
- Provides fast universal attachment of threaded rod and hardware to standard strut profiles



Material: Polyamide, Spring Steel  
Finish: nVent CADDY Armour

Part #	Description			
SLICK250	1/4" Hole, Threaded	400 lb	100 lb	100 pc
SLICK375	3/8" Hole, Threaded	600 lb	100 lb	100 pc
SLICK500	1/2" Hole, Threaded	600 lb	100 lb	100 pc

Indicated loads are independent of the threaded stud or rod. Indicated loads are applicable on 14 GA and 12 GA (2 mm and 2.5 mm) strut channels only.



# NVENT CADDY ERISTRUT

## STRUT NUT WITHOUT SPRING

- Used to create metal frames with nVent CADDY Eristrut channels



Static Load Safety Factor: 3:1

Part #	Description	
Material: Stainless Steel 316 (EN 1.4401)		
NUT0050S6	S316, 1/2" Rod, 0.5"	100 pc
Material: Steel – Finish: Electrogalvanized		
NUT0025EG	EG, 1/4" Rod, 0.25"	100 pc
NUT0037EG	EG, 3/8" Rod, 0.375"	100 pc
NUT0050EG	EG, 1/2" Rod, 0.5"	100 pc
NUT0062EG	EG, 5/8" Rod, 0.5"	100 pc

Pull-Out Strength			
Part #	Channel Type	Channel Thickness	
		12 GA	14 GA
NUT0025xx	A, C	450 lb	450 lb
	D, E	450 lb	-
NUT0037xx	A, C	1,100 lb	1,000 lb
	D, E	1,100 lb	-
NUT0050xx	A	2,000 lb	1,400 lb
	D, E	1,500 lb	-
NUT0062xx	A	2,000 lb	1,400 lb
	D, E	1,500 lb	-
NUT0075xx	A	2,000 lb	1,400 lb
	D, E	1,500 lb	-

## NVENT CADDY ERISTRUT

### STRUT NUT WITH SPRING, CHANNEL TYPE A

- Used to create metal frames with nVent CADDY Eristrut channels
- Spring allows for easy installation



Material: Steel  
Finish: Electrogalvanized  
Static Load Safety Factor: 3:1

Part #	Description	
SPRA0025EG	EG, 1/4" Rod	100 pc
SPRA0037EG	EG, 3/8" Rod	100 pc
SPRA0050EG	EG, 1/2" Rod	100 pc
SPRA0062EG	EG, 5/8" Rod	100 pc

Pull-Out Strength		
Part #	Channel Thickness	
	12 GA	14 GA
SPRA0025EG	450 lb	450 lb
SPRA0037EG	1,100 lb	1,000 lb
SPRA0050EG	2,000 lb	1,400 lb
SPRA0062EG	2,000 lb	1,400 lb

### STRUT NUT WITH SPRING, CHANNEL TYPE C

- Used to create metal frames with nVent CADDY Eristrut channels
- Spring allows for easy installation



Material: Steel  
Finish: Electrogalvanized  
Static Load Safety Factor: 3:1

Part #	Description	
SPRC0025EG	EG, 1/4" Rod	100 pc

Pull-Out Strength		
Part #	Channel Thickness	
	12 GA	14 GA
SPRC0025EG	450 lb	450 lb

# NVENT CADDY ERISTRUT

## STRUT NUT WITH TOP SPRING

- Used to create metal frames with nVent CADDY Eristrut channels
- Spring allows for easy installation

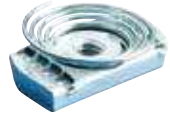

Material: Steel  
 Finish: Electrogalvanized  
 Static Load Safety Factor: 3:1

Part #	Description	
TSNT0025EG	EG, 1/4" Rod	100 pc
TSNT0037EG	EG, 3/8" Rod	100 pc
TSNT0050EG	EG, 1/2" Rod	100 pc

Pull-Out Strength			
Part #	Channel Type	Channel Thickness	
		12 GA	14 GA
TSNT0025EG	A, C	450 lb	450 lb
	D, E	450 lb	-
TSNT0037EG	A, C	1,100 lb	1,000 lb
	D, E	1,100 lb	-
TSNT0050EG	A	2,000 lb	1,400 lb
	D, E	1,500 lb	-



## CLIP-ON STRUT NUT

- Easily snaps into strut using a screwdriver



Material: Spring Steel  
 Finish: nVent CADDY Armour



Part #	Description			
MFA4I	1/4" Hole, Threaded	100 lb	50 lb	100 pc
MFA625	1/4" Hole, w/Screw, 0.625" Screw	100 lb	50 lb	100 pc

# NVENT CADDY ERISTRUT

## NVENT CADDY ROD LOCK SPRING STEEL STRUT NUT

- Easy “push-to-install” design allows installers to simply push the threaded rod through the mounting hole, instantly holding it in position
- Works with slightly damaged threads and minor burrs on the threaded rod
- Perfect for quickly installing branch runs either at the load with standard strut or at the structure in combination with embedded strut
- Integrated design eliminates the need for finicky spring nuts and loose hardware, simplifying installation
- Quickly wall mount enclosures using common threaded bolts
- Designed for use with standard strut widths (1 5/8” or 41mm) both shallow and deep profiles



Material: Spring Steel  
Finish: nVent CADDY Armour

Part #	Description	F1	F2	
4QCN	1/4" Rod	75 lb	20 lb	100 pc
5QCN	5/16" Rod	100 lb	25 lb	100 pc
6QCN	3/8" Rod	110 lb	30 lb	100 pc
8QCN	1/2" Rod	125 lb	30 lb	100 pc

The QCN requires a longer bolt than standard strut nuts. See instruction sheet for detailed information.

# nVENT CADDY ERISTRUT

## STRUT CANTILEVER ARM TYPE A, SLOTTED

- Slotted channel
- Welded on flat mounting plate



Material: Steel  
Finish: Electrogalvanized

Part #	Description	Cert	
KA25H0150EG	EG, 6" x 1.625" x 1.625" x 0.098"	ITB	20 pc
KA25H0300EG	EG, 11.875"x1.625x 1.625"x0.098"	ITB	10 pc
KA25H0450EG	EG, 17.75"x1.625"x1.625"x0.098"	ITB	5 pc
KA25H0600EG	EG, 23.625"x1.625"x1.625"x0.098"	ITB	1 pc

## SQUARE CHANNEL WASHER

- Use to secure objects to nVent CADDY Eristrut channels

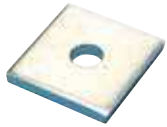

Material: Steel  
Finish: Electrogalvanized

Part #	Description	
F130000EG	EG, 5/16" Rod, 0.375" Hole	100 pc
F140000EG	EG, 3/8" Rod, 0.438" Hole	100 pc
F150000EG	EG, 1/2" Rod, 0.563" Hole	100 pc
F160000EG	EG, 5/8" Rod, 0.688" Hole	100 pc
F170000EG	EG, 3/4" Rod, 0.813" Hole	100 pc

## NVENT CADDY ERISTRUT

### TWO HOLE FLAT BRACKET

- Used to create metal frames with nVent CADDY Eristrut channels



Material: Steel  
Finish: Electrogalvanized

Part #	Description	
F090000EG	EG, 3.5"	50 pc
F220000EG	EG, 3.25"	50 pc

### THREE HOLE FLAT BRACKET

- Used to create metal frames with nVent CADDY Eristrut channels



Material: Steel  
Finish: Electrogalvanized

Part #	Description	
F200000EG	EG, 5.375"	25 pc

### THREE HOLE FLAT CORNER BRACKET

- Used to create metal frames with nVent CADDY Eristrut channels



Material: Steel  
Finish: Electrogalvanized

Part #	Description	
F360000EG	EG, 3.5" x 3.5"	25 pc

# NVENT CADDY ERISTRUT

## FOUR HOLE FLAT BRACKET

- Used to create metal frames with nVent CADDY Eristrut channels



Material: Steel  
Finish: Electrogalvanized

Part #	Description	
F230000EG	EG, 7.25"	25 pc

## FOUR HOLE FLAT CORNER BRACKET

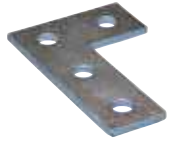

Material: Steel  
Finish: Electrogalvanized

Part #	Description	
F370000EG	3 1/2" x 5 3/8"	20 pc

## FOUR HOLE FLAT TEE PLATE

- Used to create metal frames with nVent CADDY Eristrut channels



Material: Steel  
Finish: Electrogalvanized

Part #	Description	
F250000EG	EG, 5.375" x 3.5"	20 pc

# NVENT CADDY ERISTRUT

## FIVE HOLE FLAT CROSS BRACKET



Material: Steel  
Finish: Electrogalvanized

Part #	Description	
F280000EG	EG, 5.38" x 5.38"	15 pc

## 1-1 HOLE ANGLE BRACKET

- Used to create metal frames with nVent CADDY Eristrut channels

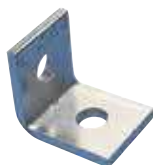

Material: Steel  
Finish: Electrogalvanized

Part #	Description	
L100000EG	EG, 2.25" x 1.625"	50 pc
L110000EG	EG, 2" x 1.875"	50 pc

## 1-1 HOLE CLOSED CORNER ANGLE BRACKET

- Used to create metal frames with nVent CADDY Eristrut channels

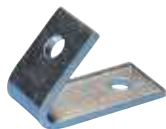

Material: Steel  
Finish: Electrogalvanized

Part #	Description	
L470450EG	EG, 45° x 3.5" x 2.5"	25 pc



# NVENT CADDY ERISTRUT

## 1-1 HOLE OPEN CORNER ANGLE BRACKET

- Used to create metal frames with nVent CADDY Eristrut channels

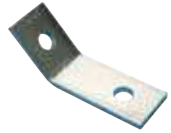

Material: Steel  
Finish: Electrogalvanized

Part #	Description	
L460450EG	EG, 45°	25 pc

## 1-1 HOLE UNEQUAL LONG ANGLE BRACKET

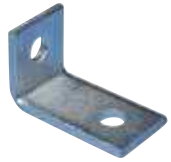

Material: Steel  
Finish: Electrogalvanized

Part #	Description	
L120300EG	3" x 1 7/8"	25 pc

## 1-2 HOLE CORNER ANGLE BRACKET

- Used to create metal frames with nVent CADDY Eristrut channels

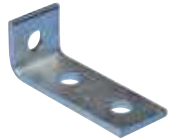

Material: Steel  
Finish: Electrogalvanized

Part #	Description	
L180000EG	EG, 3.5" x 2.5"	25 pc

## NVENT CADDY ERISTRUT

### 1-2 HOLE CORNER SHORT ANGLE BRACKET

- Used to create metal frames with nVent CADDY Eristrut channels

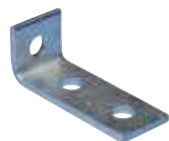

Material: Steel  
Finish: Electrogalvanized

Part #	Description	
L190000EG	EG, 3.875" x 1.875"	25 pc
L200000EG	EG, 4.125" x 1.625"	25 pc

### 2-2 HOLE CORNER ANGLE BRACKET

- Used to create metal frames with nVent CADDY Eristrut channels



Material: Steel  
Finish: Electrogalvanized

Part #	Description	
L220000EG	EG, 4.125" x 3.5"	25 pc

### 1-1 HOLE 45° ANGLE BRACE



Material: Steel  
Finish: Electrogalvanized

Part #	Description	
L441200EG	EG, 12" x 10.5"	20 pc
L441600EG	EG, 16" x 13.313"	500 pc

# NVENT CADDY ERISTRUT

## 3-3-1 HOLE CORNER GUSSET

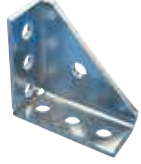

Material: Steel  
Finish: Electrogalvanized

Part #	Description	
L23U0000EG	4 1/8" x 4 1/8"	15 pc

## SIX HOLE CORNER CONNECTOR, 3-WAY

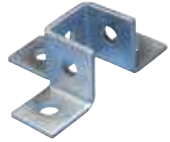

Material: Steel  
Finish: Electrogalvanized

Part #	Description	
W190000EG	1 5/8" x 5 7/16" x 2"	10 pc

## EIGHT HOLE DOUBLE CORNER CONNECTOR, 3-WAY

• Used to create metal frames with nVent CADDY Eristrut channels



Material: Steel  
Finish: Electrogalvanized

Part #	Description	
W170000EG	EG, 1.625" x 5.5" x 4"	10 pc

## NVENT CADDY ERISTRUT

### NINE HOLE CORNER CONNECTOR, 3-WAY



Material: Steel  
Finish: Electrogalvanized



Part #	Description	
W200000EG	EG, 3.5" x 5.438" x 3.75"	25 pc

### STRUT BEAM CLAMP WITH U-BOLT

- Complete with U-bolt and nuts
- Requires installation in pairs



Material: Steel  
Finish: Electrogalvanized

Part #	Description		
BC17A000EG	EG, A, C Strut	1,200 lb	25 pc
BC17D000EG	EG, AA, D, E Strut	1,200 lb	25 pc

Static Load is based on one pair of Strut Beam Clamps.

# NVENT CADDY ERISTRUT

## STRUT BEAM CLIP

- Beam Clip for clamping the open side of strut to a beam
- Suitable for all strut channels
- Requires installation in pairs
- Structural attachment to beams to support nVent CADDY Eristrut
- FM® Specification Tested

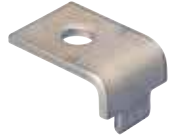

Material: Steel  
Finish: Electrogalvanized

Part #	Description	F ↓	↓ Cube
BC200000EG	EG, 0.5" Flange, 0.563" Hole	460 lb	50 pc

Indicated loads are based on installation with 1/2" (M12) hardware and strut channel type A.

## STRUT BEAM CLAMP WITH BOLT, WINDOW SHAPE

- Complete with bolt
- Requires installation in pairs



Material: Steel  
Finish: Electrogalvanized

Part #	Description	F ↓	↓ Cube
BC16A000EG	EG, A, CC Strut	740 lb	20 pc

# nVENT CADDY ERISTRUT

## INTERNAL STRUT BEAM CLAMP WITH BOLT

- U-shaped clip for clamping the back of strut channel to a beam
- Hex bolt included
- Requires installation in pairs



Material: Steel  
Finish: Electrogalvanized

Part #	Description	F	□
BC180037EG	EG, 3/8" Screw	660 lb	25 pc

Static Load is based on one pair of Strut Beam Clamps. Include strut channel thickness when calculating flange thickness.

## STRUT AND ROD BEAM CLAMP

- Multifunctional beam clamp suitable for strut channel or threaded rod
- Bolt included
- Requires installation in pairs



Material: Steel  
Finish: Electrogalvanized



Part #	Description	F	□
STCB6	3/8" Rod, 2" Max Flange	400 lb	10 pc

# NVENT CADDY ERISTRUT

## BC23 INTERNAL STRUT BEAM CLAMP

- Kit of two inserts for A type channel
- Complete with pointed head hex bolts for easy installation



Material: Steel  
Finish: ElectroGalvanized

Part #	Description	F	↓	☐
BC23A000EG	Internal Strut Beam Clamp	800 lb		25 pc

## INC8 INTERNAL STRUT BEAM CLAMP

- Mounts strut within beams



Material: Spring Steel  
Finish: nVent CADDY Armour

Part #	Description	F	↓	☐
INC8T5	INC8 Internal Strut Beam Clamp	100 lb		100 pc

Strut channel must be cut 3/4" (20mm) shorter than the inner distance between the two beam flanges in order to accommodate the clamps.

# NVENT CADDY ERISTRUT

## POST BASE FOR STRUT TYPE A

- Post base to create metal frames for attachment to nVent CADDY Eristrut



Material: Steel  
Finish: Electrogalvanized

Part #	Description	
P11SQ000EG	EG, 6" x 6" x 3.5" x 0.81"	5 pc

## 45° POST BASE FOR STRUT TYPE A

- Post base to create metal frames for attachment to nVent CADDY Eristrut or nVent CADDY Pyramid



Material: Steel

Part #	Description	
Finish: Electrogalvanized		
P110000EG	EG, 6" x 6" x 3.5"	5 pc
Finish: Hot-Dip Galvanized		
P110000HD	HD, 6" x 6" x 3.5"	5 pc



# NVENT CADDY ERISTRUT

## 45° POST BASE FOR STRUT TYPE AA

- Post base to create metal frames for attachment to nVent CADDY Eristrut or nVent CADDY Pyramid

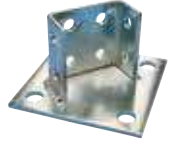

Material: Steel  
Finish: Electrogalvanized

Part #	Description	
P130000EG	EG, 6" x 3.5"	5 pc

## RECTANGULAR POST BASE PLATE

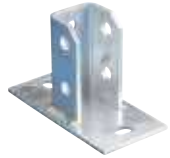

Material: Steel  
Finish: Hot-Dip Galvanized

Part #	Description	
ZGA512	3.94" x 6.3" x 3.15"	5 pc

## FOUR HOLE EXTERNAL COUPLER

- Used to create metal frames with nVent CADDY Eristrut channels



Material: Steel  
Finish: Electrogalvanized

Part #	Description	
U24A0000EG	EG, A Strut	10 pc

# NVENT CADDY ERISTRUT

## 2-2 HOLE ADJUSTABLE STRUT SWIVEL BRACKET

- Strut to strut applications for seismic bracing



Material: Steel  
Finish: Hot-Dip Galvanized

Part #	Description	
ZAA180	2-2 Hole Adjustable Strut Swivel Bracket	10 pc

## STRUT TRAPEZE ATTACHMENT PLATE

- Creates fast install trapeze brackets
- Includes hex bolt and strut nut



Material: Steel  
Finish: ElectroGalvanized

Part #	Description	
ISSP375	3/8" Rod	100 pc

# NVENT CADDY ERISTRUT

## STRUT TRAPEZE ATTACHMENT KIT

- Kit includes 2 strut trapeze attachment plates and 4 SN series nuts
- Creates fast install trapeze brackets

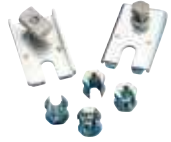

Material: Steel  
Finish: Electrogalvanized

Part #	Description	F ↓	☐
ISSPK	3/8" Rod	500 lb	12 pc

Ultimate Static Load is based on one strut trapeze attachment plate supported by two SN Series Nuts. When evaluating the complete trapeze structure (Strut Trapeze Attachment Kit and strut member), deformation and material yield of the strut must be taken into consideration. The lesser of the loads should be used as the Ultimate Static Load.

## STRUT TROLLEY, ONE AXLE

- Fits in A channel or higher



Material: Steel  
Finish: Electrogalvanized

Part #	Description	☐
ROL10000EG	Strut Trolley, One Axle	25 pc

## STRUT TROLLEY, TWO AXLES

- Fits in A channel or higher



Material: Steel  
Finish: Electrogalvanized

Part #	Description	☐
ROL11000EG	Strut Trolley, Two Axles	10 pc

## NVENT CADDY ERISTRUT

### ESC STRUT ATTACHMENT CLIP

- Attaches to open side of a strut channel
- Designed to accept nVent CADDY Speed Link wire rope or hook



Material: Spring Steel  
Finish: nVent CADDY Armour



Part #	Description	F ↓	📦
ESC4	Plain	150 lb	100 pc

### THREADED ROD TO STRUT CLIP

- Attaches to open side of a strut channel
- With threaded rod attachment



Material: Steel  
Finish: nVent CADDY Armour



Part #	Description	F ↓	📦
ESC4TI	1/4" Hole	150 lb	100 pc
ESC6TI	3/8" Hole	150 lb	100 pc

### SOUND INSULATION RUBBER FOR STRUT PIPE CLAMPS

- For use in strut pipe clamps
- Suitable for high temperatures



Material: EPDM-SBR Rubber  
Temperature: -76 to 376 °F

Part #	Description	📦
VS200000	Sound Insulation Rubber for Strut Pipe Clamps	20'

# Technical Section

## I. MATERIALS & FINISHES

Technical Section



# Technical Section

## I. Materials & Finishes

### MATERIALS – METALS

---

#### STEEL

Steel is an alloy of iron and other elements, the most common being carbon. Varying the amount of alloying elements and the form of their presence in the steel controls qualities such as the hardness, ductility, tensile strength and corrosion resistance of the resulting steel.

#### SPRING STEEL

Spring steel is an alloy of iron and carbon. Spring steel alloys can be easily formed into complex shapes, and then heat-treated to greatly increase strength.

nVent CADDY spring steel fasteners are heat treated in modern shaker hearth furnaces. Parts are conveyed directly from a high temperature furnace to a quench tank, through a cleaning cycle and into a tempering furnace. Precision controls maintain heat treat operations within established limits developed for nVent CADDY fasteners.

\*Note : Spring steel fasteners are for indoor use in non-corrosive environments. Mild steel fasteners can be used outdoors in humid or mildly corrosive environments. Not to be used in certain areas such as over indoor pools, etc.

#### STAINLESS STEEL

Stainless Steel is an alloy of iron and carbon that is more resistant to rust, staining and corrosion than regular steel.

#### STAINLESS SPRING STEEL 301

A highly ductile steel used on formed products that hardens rapidly during mechanical working. Stainless 301 has better wear resistance and fatigue strength than Stainless 304 or standard Spring Steel.

#### STAINLESS STEEL 304 (1.4301)

The most familiar stainless steel is Type 304, containing 18-20% chromium and 8-10% nickel.

- Also referred to as 'A2'

#### STAINLESS STEEL 316 (1.4401)

The second most common stainless steel is 316, also called marine grade stainless, used primarily for its increased resistance to corrosion.

- Also referred to as 'A4'

#### CAST IRON

Cast Iron is a commercial alloy of iron, carbon and silicon that is cast in a mold. This results in a product that is hard, brittle, non-malleable and incapable of being hammer-welded but more easily fusible than steel.

# Technical Section

## I. Materials & Finishes

### MATERIALS – PLASTICS AND RUBBERS

#### PLASTICS VERSUS THERMOSETS

- Thermoplastics will melt and flow when heated.
- Thermosets have undergone an irreversible chemical reaction and additional heat will not melt them further.

#### POLYETHYLENE (PE)

Polyethylene is a tough, light, flexible synthetic resin and is the most common thermoplastic. Many different grades exist with a broad range of physical properties.

#### POLYPROPYLENE (PP)

Polypropylene is a thermoplastic that is light, rugged and resistant to many chemical solvents, bases and acids. It is typically tough and flexible.

#### POLYVINYL CHLORIDE (PVC)

Polyvinyl chloride (abbreviated PVC), is a thermoplastic made from a tough, chemically resistant synthetic resin. Unplasticized PVC is stiff and strong, but can be made softer and more flexible by the addition of plasticizers.

#### EPDM RUBBER

EPDM (Ethylene Propylene Diene Monomer) is a thermoset elastomer that is inherently resistant to ozone, water and weather, and characterized by a wide range of applications.

#### SBR RUBBER

SBR (Styrene Butadiene Rubber) is the most common type of synthetic rubber. This thermoset has good

abrasion resistance, flexibility, and aging stability when protected by additives.

#### NYLON

Nylon is part of a family of thermoplastics known generically as polyamides. It is generally characterized by its durability, high elongation and excellent abrasion resistance.

#### POLYAMIDE

See nylon

#### XENOY

Xenoy is a thermoplastic blend that offers good chemical resistance, great impact resistance (even at low temperatures), and some heat resistance in conditions that require a high degree of toughness.

#### POLYISOCYANURATE

Polyisocyanurate (also called PIR, polyiso, or ISO) is a cellular, thermoset that is typically produced as a foam and used in rigid thermal insulation. As a result of its excellent thermal insulating efficiency, polyiso foam has become the standard for low temperature insulation applications.

#### HYDROUS CALCIUM SILICATE

Hydrous calcium silicate is an asbestos-free insulating material that can be molded into rigid shapes and forms for applications where precise temperature control, personnel protection and energy savings are required.

# Technical Section

## I. Materials & Finishes

### FINISHES

---

#### PAINTED

Paint is any liquid composition, which after application to a surface in a thin layer, is converted to a solid film. It is most commonly used to protect, color or provide texture to objects.

#### nVENT CADDY ARMOUR

ISO 12944-6 C4

The Armour coating system features bi-metallic corrosion protection with an inorganic basecoat for sacrificial protection and an organic topcoat for barrier protection. The nVent standard for Armour includes at least 1,000 hours resistance against red rust when tested per the ASTM B117 and DIN 50021 salt spray tests. Armour is RoHS compliant.

#### ELECTRO-GALVANIZED (EG)

ASTM B633

This corrosion protective coating is applied after the fabrication of steel or malleable iron parts and uses an electrolytic plating process that deposits zinc. A second passivation coating of chromate is then applied for additional protection. Zinc electroplate products are recommended for indoor and mildly corrosive applications.

#### PRE-GALVANIZED ZINC (PG)

ASTM A653/A653M

Pre-galvanized zinc is produced by continuously rolling steel coils or sheets through molten zinc at the mills. The coils or sheets are slit to size and fabricated by forming, shearing or punching to produce the finished product. During fabrication cut edges are not generally zinc coated; however, the zinc near

the uncoated metal becomes a sacrificial anode to protect the bare areas. Pre-galvanized zinc products are generally recommended for indoor use on mildly corrosive environments.

#### HOT DIP GALVANIZED ZINC (HDG)

ASTM A123

After a product has finished its fabrication process, it is dipped into a bath of molten zinc. The zinc completely coats all edges and surfaces. Zinc thickness is controlled by the time the part is immersed in the molten zinc bath. Hot dip galvanized zinc products are recommended for indoor, outdoor and mildly corrosive environments.

#### BLACK OXIDE

ASTM D769

Black oxide or blackening is a conversion coating for ferrous materials, copper and copper based alloys, zinc, powdered metals, and silver solder. It is used to add mild corrosion resistance and for appearance.

#### COPPER ELECTRO-PLATED

Copper plating is the process in which a thin layer of copper is deposited on an item via an electric current.

#### EPOXY POWDER COATED

Epoxy powder coating is applied electrostatically as a free-flowing, dry powder and finished by curing under heat to form a "skin". It is typically used to create a durable, hard wearing finish that is tougher than conventional paint.



# Technical Section

## II. PIPE HANGER & SUPPORT RECOMMENDED SPECIFICATIONS

Technical Section



# Technical Section

## II. Pipe Hanger & Support Recommended Specifications

This specification has been compiled from generally accepted engineering principles and standards from the American National Standards Institute (ANSI®), Manufacturers Standardization Society (MSS), Factory Mutual (FM), Underwriters Laboratories (UL®) and other pertinent documents. The specification is intended as a guide only and it is the design engineers responsibility to use it in conjunction with the data found in this catalog to determine the best product or products for the user's application. The Model numbers are those of nVent.

### I. MATERIAL DESIGN AND MANUFACTURE

All pipe hanger and supports shall be manufactured to comply with the latest edition of MSS-SP-58. Where applicable, design and manufacture of these products must also conform to

ANSI/ASME® Code for Pressure Piping, B31.1; UL203 Standard for Pipe Hanger Equipment and Fire Protection Service; Factory Mutual FM1951 Approval Standard for Pipe Hanger Components for Automatic Sprinkler Systems; Metal Framing Manufacturers Association, MFMA-2 and Local Building Codes. Pipe hangers and supports shall be supplied by nVent.

### II. SELECTION

#### A. STANDARDS

All selection and installation of pipe supports shall conform to MSS-SP-58 and other specifications that may apply which are listed in this document.

#### B. LOAD CALCULATIONS

Hangers, supports, anchors and restraints must be selected to withstand all static and dynamic loading conditions which act upon the piping system and associated equipment. Piping supports and equipment must be considered as a total system and appropriate balance calculations made to determine load forces at critical

stress points. Loading conditions to be considered may include but are not limited to:

1. The total load of pipe, fittings, valves, insulation and any expected contents of the pipe.
2. Thermal expansion and contraction.
3. Stress from cycling of equipment or process.
4. Vibration transmitted to or from equipment or terminal connection.
5. Wind, snow or ice loading on outdoor piping.
6. Loading due to seismic forces if required by code or specification.

#### C. STRUCTURAL LOADS

Static and dynamic forces at points of attachment must be considered to help ensure structural integrity of buildings or equipment. Hanger and supports must be selected so as to minimize the effect of piping system loading on the structure.

#### D. MATERIALS

1. Appropriate materials and protective coatings shall be used to prevent failure from environmental and galvanic corrosion.
2. Material that comes in contact with pipe shall be compatible with piping material so that neither has a deteriorating effect on the other.

#### E. HANGER SPACING

The maximum allowable spacing for pipe hangers shall be in accordance with Hanger Locations and Spacing Table on page 359. Where concentrated loads of flanges, valves, fittings, etc. occur, or there are building structural loading limitations, close spacing will be necessary and shall be based on the weight to be supported and the maximum recommended loads for the pipe hangers.

#### F. PIPE ATTACHMENTS – HOT SYSTEMS

1. Hot systems are classified as those piping systems that have operating temperatures over 120°F (49°C).

# Technical Section

## II. Pipe Hanger & Support Recommended Specifications

2. Systems with operating temperatures over 450°F (232°C) require special designs for any hanger or support that is in direct contact with pipe. This is important in determining the raw materials needed as required by MSS SP-58. Maximum operating temperatures should be specified to the support manufacturer.
3. If piping is insulated, the connection of the pipe attachments to the hanger rod shall be outside the insulation so that movement of the line will not cause damage to the insulation.
4. Horizontal hot piping shall allow for expansion and contraction. If pipe movement is negligible, a nVent CADDY Model #103 shall be used for pipe up thru 3". If pipe is supported from above and the movement is less than 4°, hanger components shall be selected to allow for swing using Models #450 or #452 Pipe Clamps in conjunction with a Model #35 Forged Steel Eye Nut. If the swing is greater than 4°, a traveling device should be provided for horizontal movement. If pipe is supported from above, Models #605 or #610 Roller Hangers are to be used. For piping supported below, use nVent CADDY #615, #617, or #619 Roller Supports. Models #630 thru #635 Protection Saddles should be tack welded to the pipe to protect the insulation from damage due to pipe movement and then filled with the specified insulating material.
5. Vertical hot piping requires a resilient support if significant movement occurs due to expansion and contraction of the pipe. Selection of the supports depends on the permissible load variation and effects on adjacent equipment. If vertical movement is negligible an Model #510 shall be used for steel pipe or a Model #511 shall be used for copper pipe. Use nVent CADDY Variable Spring Hangers if supporting force must be limited to 6 percent and cannot

be accommodated by a Variable Spring Hanger, Constant Support Hangers should be specified.

### G. PIPE ATTACHMENTS – AMBIENT SYSTEMS

1. Ambient systems are classified as those piping systems that have operating temperatures between 60°F (16°C) and 119°F (48°C).
2. Horizontal piping systems shall be supported by nVent CADDY Swivel Loop Hangers for 1/2"-8" steel pipe and Clevis Hangers for steel pipe 8" and larger. Copper pipe shall be supported by Model #102A PVC Coated Swivel Loop Hanger.
3. Vertical piping requires support at each floor by Model #510 EZ Riser Clamp for steel pipe and Model #511 EZ Riser Clamp for copper pipe. Also acceptable are U-bolts, Model #150M used with steel plates bolted securely to building structure or equipment framing.

### H. PIPE ATTACHMENTS – COLD SYSTEMS

1. Cold systems are classified as those piping systems that have operating temperature below 60°F (16°C).
2. Hangers exposed to temperatures below -40°F (-40°C) require special design by the design engineer.
3. Horizontal piping requiring insulation shall be provided with vapor barriers. Under no circumstances shall supports or guides be applied directly to horizontal pipe or tubing on vapor barriered lines. Pipe shall be supported by nVent Model #103 Pre-Insulated Swivel Loop Hangers for pipe up to 3" and Model #403 Pre-Insulated Clevis Hangers for pipe larger than 3". Pipe not requiring insulation shall be supported in the same manner as required for ambient temperature piping.
4. Vertical piping requirements are the same as required for ambient piping systems.

# Technical Section

## II. Pipe Hanger & Support Recommended Specifications

### I. PIPE ATTACHMENTS – PLASTIC PIPE

1. Rigid plastic pipe (ABS, PVC, CPVC etc.) shall be supported by hangers with a welded-in support shield to spread the load bearing surface, Model #103 for sizes through 6" pipe and Model #403 on 8" pipe and larger.
2. Flexible plastic (polyethylene, etc.) shall be supported continuously by an 18 gauge sheet metal through Model #104 and #VTR.

### J. PIPE ATTACHMENTS – GLASS PIPE

Glass pipe shall be supported with a PVC cushioned wrought steel swivel loop hanger, Model #102.

### K. SPECIALTY PIPING

Asbestos Cement, Reinforced Fiberglass or any other specialty piping shall be supported per the pipe manufacturer's recommendations.

### L. INTERMEDIATE ATTACHMENTS

1. Where negligible movement of pipe occurs at hanger locations, the below listed minimum hanger rod sizes shall be used.

Nominal Pipe or Tubing Size	Minimum Rod Size
1/4" - 2"	3/8"
2-1/2" - 3-1/2"	1/2"
4" - 5"	5/8"
6"	3/4"
8" - 12"	7/8"
14" - 18"	1"
20" - 24"	1-1/4"

2. Where significant vertical movement of the pipe occurs at the support location, a resilient support shall be used. Selection of resilient supports shall be based on permissible variation and effects on adjacent equipment. Use nVent CADDY Variable Spring Hangers or if supporting force must be limited to percent and cannot be accommodated by a Variable Spring Hanger, a Constant

Support Spring Hanger should be specified.

3. The contractor shall furnish all miscellaneous hardware items designed to be utilized with various support components such as bolts, nuts, washers, turnbuckles, etc. All threads must use lock nuts or vibration resistant nuts where potential vibration may cause failure.

### M. STRUCTURAL ATTACHMENTS

1. In general, piping shall be supported from walls, beams, columns and slabs using approved structural attachments. In situations where approved attachments cannot be used, alternative attachments or substructure assemblies must receive approval prior to installation. Prior approval must be given for any cutting or drilling of building structural steel. Damage to the structure through welding, cutting or drilling will not be permitted if it reduces the structures strength to a point below the established safety factor for said structure. Approvals may only be granted by a qualified structural engineer.
2. BUILDING STEEL HORIZONTAL: For eccentric loading applications, utilize the Model #300 or #310 Universal Beam attachments For concentric loading, utilize the Model # 360 or #361 Center Load Beam Clamps.
3. BUILDING STEEL VERTICAL: Use Models: #348, #352 or #353 Steel Wall Brackets where horizontal piping adjustment is necessary; where vertical piping adjustment is necessary use strut, Models: #A12, #B12 or #C14 with strut pipe clamps; Model #RIGD, or strut tubing clamps; Model #COPC, or #USC.
4. POURED CONCRETE CEILING, AND WALLS: Use accurately located spot inserts, nVent Model #355 or Continuous Inserts Model # CONCT and place on forms before concrete is poured.

# Technical Section

## II. Pipe Hanger & Support Recommended Specifications

5. Where pre-set spot inserts cannot be in place before the pour, use expansions shields, Model #345 CA series, or as approved. No drilling of precast, pre-stressed concrete will be permitted. Special types of clamps which attach to the precast slab ribbing shall be provided as structural attachments.
6. Expansion loops and expansion joints shall have pipe guides, Models: #650 and #651 on each side of the loop or joint to maintain alignment. Each line that has this expansion potential shall be anchored to the structure at each change of direction.
7. Any additional structural steel required to properly

## N. MAXIMUM HORIZONTAL PIPE HANGER AND SUPPORT SPACING

### 1. MSS SP-58-2009

Nominal Pipe or Tube Size		STD WT Steel Pipe				Copper Tube			
		Water Service		Vapor Service		Water Service		Vapor Service	
NPS (In.)	DN (mm)	ft	m	ft	m	ft	m	ft	m
1/4	8					5	1.5	5	1.5
3/8	10	7	2.1	8	2.4	5	1.5	6	1.8
1/2	15	7	2.1	8	2.4	5	1.5	6	1.8
3/4	20	7	2.1	9	2.7	5	1.5	7	2.1
1	25	7	2.1	9	2.7	6	1.8	8	2.4
1-1/4	32	7	2.1	9	2.7	7	2.1	9	2.7
1-1/2	40	9	2.7	12	3.7	8	2.4	10	3.0
2	50	10	3.0	13	4.0	8	2.4	11	3.4
2-1/2	65	11	3.4	14	4.3	9	2.7	13	4.0
3	80	12	3.7	15	4.6	10	3.0	14	4.3
3-1/2	90	13	4.0	16	4.9	11	3.4	15	4.6
4	100	14	4.3	17	5.2	12	3.7	16	4.9
5	125	16	4.9	19	5.8	13	4.0	18	5.5
6	150	17	5.2	21	6.4	14	4.3	20	6.1
8	200	19	5.8	24	7.3	16	4.9	23	7.0
10	250	22	6.7	26	7.9	18	5.5	25	7.6
12	300	23	7.0	30	9.1	19	5.8	28	8.5
14	350	25	7.6	32	9.8	NA	NA	NA	NA
16	400	27	8.2	35	10.7	NA	NA	NA	NA
18	450	28	8.5	37	11.3	NA	NA	NA	NA
20	500	30	9.1	39	11.9	NA	NA	NA	NA
24	600	32	9.8	42	12.8	NA	NA	NA	NA
30	750	33	10.1	44	13.4	NA	NA	NA	NA

NOTE: These spacings do not apply where span calculations are made or where there are concentrated loads between supports such as flanges, valves, specialties, etc. or changes in direction requiring additional supports.

# Technical Section

## II. Pipe Hanger & Support Recommended Specifications

2. Fire Protection:  
follow requirements of the National Fire Protection Assoc.
3. Ductile Iron Pipe:  
10 feet (3.0 m) maximum spacing with a minimum of one (1) hanger per section close to joint on the behind the bell and at change of direction and branch connections. For pipe sizes 6" and under, installed on ASME B31 projects, that are subjected to loadings other weight of pipe and contents, the span should be limited to the maximum spacing for water service steel pipe.
4. Cast Iron Soil:  
10 feet (3.0 m) maximum spacing with a minimum of one (1) hanger per section close to joint on the barrel. Also at change of direction and branch connection.
5. Glass:  
8 feet (2.4 m) maximum spacing, follow manufacturer's recommendations.
6. Plastic:  
follow pipe manufacturer's recommendations for material and service condition.
7. FIBERGLASS REINFORCED:  
follow pipe manufacturer's recommendations for spacing material and service condition.
8. NO SUB SOIL PIPE:  
horizontal piping shall be hung at every other joint except when the developed length between the hangers exceeds four (4) feet, the pipe shall be hung at each joint. Hangers shall be provided at each horizontal branch connection, on each water closet bend or elbow and at each trap. Where piping and fittings are suspended on hangers more than 18 inches

long and on each water closet bend or elbow, rigid hangers or sway bracing shall be provided at every other hanger and hung piping and closet bends shall not have any horizontal movement in any direction. Hangers shall be placed within one inch of the coupling at each joint requiring a hanger. Vertical piping shall be supported at each floor level including slabs on grade with riser clamps.

9. In general, a hanger shall be used within one foot of each change of direction and at each valve or equipment connection.

### O. SPECIAL SITUATIONS

In general, all special situations not specifically covered herein must be approved prior to installation.

### P. ATTACHMENTS MADE BY WELDING

All welded type support components shall be in accordance with MSS-SP-58. All attachments welded to the pipe shall be in accordance with MSS-SP-58 and Pipe Fabrication Institute, Standard ES-26. Welded and bolted attachments to the building structural steel shall be in accordance with the requirements of AISC Specification for the Design, Fabrication and Erection of Structural Steel Buildings.

Some text in Sections N through P was extracted from ANSI/MSS SP-58-2009, with permission of the publisher, The Manufacturer's Standardization Society of the Valve and Fittings Industry).

Visit [nVent.com/ERICO](http://nVent.com/ERICO) for the most current specifications.

# Technical Section

## II. Pipe Hanger & Support Recommended Specifications

### STEEL PIPE DATA (SCHEDULE 40 & 80)

Nominal Pipe Size (Inches)	Sched. Number	OD of Pipe (Inches)	Wall Thickness (Inches)	Weight (lbs/ft)	Weight of Pipe filled w/ Water (lbs/ft)
3/8	40	.675	.091	.567	.647
	80		.126	.738	.798
1/2	40	.840	.109	.850	.980
	80		.147	1.09	1.19
3/4	40	1.050	.113	1.13	1.36
	80		.154	1.47	1.66
1	40	1.315	.133	1.68	1.99
	80		.179	2.17	2.54
1-1/4	40	1.660	.140	2.27	2.92
	80		.191	3.00	3.56
1-1/2	40	1.900	.145	2.72	3.60
	80		.200	3.63	4.40
2	40	2.375	.154	3.65	5.10
	80		.218	5.02	6.30
2-1/2	40	2.875	.203	5.79	7.86
	80		.276	7.66	9.49
3	40	3.500	.216	7.58	10.78
	80		.300	10.25	13.11
3-1/2	40	4.000	.226	9.11	13.39
	80		.318	12.51	16.36
4	40	4.500	.237	10.79	16.30
	80		.337	14.98	19.96
5	40	5.563	.258	14.62	23.28
	80		.375	20.78	28.65
6	40	6.625	.280	18.98	31.49
	80		.432	28.57	39.86
8	40	8.625	.322	25.55	47.15
	80		.500	43.40	63.20
10	40	10.750	.365	40.50	74.60
	80		.593	64.74	95.84
12	40	12.750	.406	53.60	102.10
	80		.687	88.60	132.60
14	40	14.000	.437	63.37	121.87
	80		.750	107.00	158.20
16	40	16.000	.500	83.00	159.50
	80		.843	137.00	206.70
18	40	18.000	.563	105.00	202.20
	80		.937	171.00	259.50
20	40	20.000	.593	123.00	243.40
	80		1.031	209.00	318.40
24	40	24.000	.687	171.00	345.20
	80		1.218	297.00	455.20

# Technical Section

## II. Pipe Hanger & Support Recommended Specifications

### STANDARD COPPER TUBING DATA

Nom. Size (In.)	Type "K"				Type "L"		
	OD (In.)	ID (In.)	Weight (lbs/ft)	Wt. Filled With Water (lbs/ft)	ID (In.)	Weight (lbs/ft)	Wt. Filled With Water (lbs/ft)
1/4	.375	.305	.145	.177	.315	.126	.160
3/8	.500	.402	.269	.275	.430	.198	.261
1/2	.625	.527	.344	.438	.545	.285	.385
5/8	.750	.652	.418	.563	.666	.362	.512
3/4	.875	.745	.641	.829	.785	.455	.667
1	1.125	.995	.839	1.176	1.025	.655	1.011
1-1/4	1.375	1.245	1.040	1.570	1.265	.884	1.427
1-1/2	1.625	1.481	1.360	2.109	1.505	1.140	1.889
2	2.125	1.959	2.060	3.364	1.985	1.750	3.092
2-1/2	2.625	2.435	2.930	4.927	2.465	2.480	4.539
3	3.125	2.907	4.000	6.870	2.945	3.330	6.263
3-1/2	3.625	3.385	5.120	9.051	3.425	4.290	8.284
4	4.125	3.857	6.510	11.564	3.905	5.380	10.559
5	5.125	4.805	9.670	17.532	4.875	7.610	15.697
6	6.125	5.741	13.900	25.132	5.845	10.200	21.806
8	8.125	7.583	25.900	45.494	7.725	19.300	39.580
10	10.125	9.449	40.300	70.689	9.625	30.100	61.612
12	12.125	11.315	57.800	101.355	11.565	40.400	85.890

### AWWA CAST IRON PIPE (CLASS 150)

Nominal Pipe Size (In.)	OD of Pipe (In.)	Wall Thickness (in.)	Weight of Pipe (lbs/ft)	Weight of Pipe Filled w/Water (lbs/ft)
3	3.96	.32	12.19	15.92
4	4.80	.35	16.25	21.97
6	6.90	.38	25.63	38.43
8	9.05	.41	36.56	59.66
10	11.10	.44	48.44	73.94
12	13.20	.48	62.82	113.82
14	15.30	.51	78.75	148.05
16	17.40	.54	95.00	185.30
18	19.50	.58	114.69	228.69
20	21.60	.62	135.94	277.44
24	25.80	.73	190.31	391.31
30	32.00	.85	277.19	589.19
36	38.30	.94	365.90	814.90
42	44.50	1.05	475.30	1087.30
48	50.80	1.14	589.60	1392.60



# Technical Section

## II. Pipe Hanger & Support Recommended Specifications

### SERVICE WEIGHT CAST IRON SOIL PIPE (BELL & SPIGOT TYPE)

Nominal Pipe Size (In.)	OD of Pipe (In.)	Wall Thickness (In.)	Weight of Pipe (lbs/ft)	Weight of Pipe Filled w/ Water (lbs/ft)
2	2.25	.17	4.0	5.5
3	3.25	.17	6.0	9.4
4	4.25	.18	8.0	14.2
5	5.25	.18	10.4	22.7
6	6.25	.18	13.0	26.9
8	8.38	.23	20.0	45.7
10	10.5	.28	29.0	69.6
12	12.5	.28	38.0	96.2
15	15.62	.31	51.0	147.6

Based on ASTM® A74

### EXTRA WEIGHT CAST IRON SOIL PIPE (BELL & SPIGOT TYPE)

Nominal Pipe Size (In.)	OD of Pipe (In.)	Wall Thickness (In.)	Weight of Pipe (lbs/ft)	Weight of Pipe Filled w/ Water (lbs/ft)
2	2.38	.19	5.0	6.6
3	3.50	.25	9.0	12.7
4	4.50	.25	12.0	18.5
5	5.50	.25	15.0	25.2
6	6.50	.25	19.0	33.7
8	8.62	.31	30.0	56.1
10	10.75	.37	43.0	83.8
12	12.75	.38	54.0	112.8
15	15.88	.44	75.0	166.8

Based on ASTM® A74

### NO HUB CAST IRON SOIL PIPE

Nominal Pipe Size (In.)	OD of Pipe (In.)	Wall Thickness (In.)	Weight of Pipe (lbs/ft)	Weight of Pipe Filled w/ Water (lbs/ft)
1-1/2	1.90	.16	2.7	6.2
2	2.35	.16	3.6	8.6
3	3.35	.16	5.2	13.5
4	4.38	.19	7.4	20.2
5	5.30	.19	9.6	27.5
6	6.30	.19	11.0	34.0
8	8.38	.23	18.0	57.5

Based on ASTM® A74

# Technical Section

## II. Pipe Hanger & Support Recommended Specifications

### PVC PLASTIC PIPE

Nominal Pipe Size (In.)	Schedule Number	OD of Pipe (In.)	Wall Thickness (In.)	Weight (lbs/ft)	Weight of Pipe Filled w/Water (lbs/ft)
1/8	40	.405	.068	.043	.068
	80		.095	.055	.071
1/4	40	.540	.088	.074	.119
	80		.119	.094	.125
3/8	40	.675	.091	.100	.183
	80		.126	.129	.190
1/2	40	.840	.109	.150	.282
	80		.147	.150	.251
3/4	40	1.050	.113	.199	.429
	80		.154	.295	.481
1	40	1.315	.133	.295	.669
	80		.179	.382	.693
1-1/4	40	1.660	.140	.400	1.047
	80		.191	.527	1.082
1-1/2	40	1.900	.145	.478	1.360
	80		.200	.639	1.404
2	40	2.375	.154	.643	2.095
	80		.218	.884	2.163
2-1/2	40	2.875	.203	1.020	3.092
	80		.276	1.350	3.184
3	40	3.500	.216	1.333	4.533
	80		.300	1.804	4.664
3-1/2	40	4.000	.226	1.598	5.878
	80		.318	2.195	6.045
4	40	4.500	.237	1.899	7.409
	80		.337	2.636	7.616
5	40	5.563	.258	2.770	11.430
	80		.375	4.126	11.996
6	40	6.625	.280	3.339	15.489
	80		.432	5.028	16.318
8	40	8.625	.322	5.280	26.880
	80		.500	8.023	27.823
10	40	10.750	.366	7.505	41.605
	80		.593	11.894	42.994
12	40	12.750	.406	10.023	58.523
	80		.687	16.365	60.365

# Technical Section

## II. Pipe Hanger & Support Recommended Specifications

### GLASS PIPE DATA

Nominal Pipe Size (In.)	OD of Pipe (In.)	Wall Thickness (In.)	Weight of Pipe (lbs/ft)	Weight of Pipe Filled w/Water (lbs/ft)
<b>Regular Schedule</b>				
1-1/2	1.84	.12	.64	.89
2	2.34	.14	.94	1.45
3	3.41	.17	1.60	3.19
4	4.53	.20	2.60	5.79
6	6.66	.24	4.70	12.78
<b>Heavy Schedule</b>				
1	1.31	.16	.60	.95
1-1/2	1.84	.17	.87	1.63
2	2.34	.17	1.10	2.46
3	3.41	.20	2.00	5.06
4	4.53	.26	3.40	N/A
6	6.66	.33	6.30	N/A

### INSULATION SHIELDS AND HANGERS – SIZING CHART FOR COPPER TUBING

Nominal Pipe (Inches)		Insulation Thickness			
Size	OD	1/2"	3/4"	1"	1-1/2"
1/2	0.625	1-1/2	1-1/2	2-1/2	3-1/2
3/4	0.875	2	2	2-1/2	3-1/2
7/8	1.000	2	2-1/2	3	3-1/2
1	1.125	2	2-1/2	3	3-1/2
1-1/4	1.375	2	2-1/2	3	4
1-1/2	1.625	2-1/2	3	3-1/2	4-1/2
2	2.125	3	3-1/2	4	5
2-1/2	2.625	3-1/2	4	4	5
3	3.125	4	4-1/2	5	6
3-1/2	3.625	4-1/2	4-1/2	6	6
4	4.125	5	5	7	7
5	5.125	6	6	8	8
6	6.125	7	7	9	9

# Technical Section

## II. Pipe Hanger & Support Recommended Specifications

### INSULATION SHIELDS AND HANGERS – SIZING CHART FOR IRON PIPE

Nominal Pipe (Inches)		Insulation Thickness				
Size	OD	1/2"	3/4"	1"	1-1/2"	2"
1/2	0.840	2	2	2-1/2	3-1/2	4-1/2
3/4	1.050	2	2-1/2	2-1/2	3-1/2	4-1/2
1	1.315	2	2-1/2	3	4	5
1-1/4	1.660	2-1/2	3	3	4-1/2	5
1-1/2	1.900	2-1/2	3	3-1/2	4-1/2	6
2	2.375	3	3-1/2	4	5	6
2-1/2	2.875	3-1/2	4	4-1/2	6	7
3	3.500	4	4-1/2	5	7	8
3-1/2	4.000	4-1/2	5	6	7	8
4	4.500	5	6	6	7	8
5	5.562	6	7	7	8	9
6	6.625	7	8	8	9	10
8	8.625	9	10	10	11	12
10	10.750	11	12	12	14	15
12	12.750	14	14	14	16	17

Nominal Pipe (Inches)		Insulation Thickness				
Size	OD	2-1/2"	3"	3-1/2"	4"	4-1/2"
1/2	0.840	6	7	–	–	–
3/4	1.050	6	7	–	–	–
1	1.315	6	7	–	–	–
1-1/4	1.660	6	7	–	–	–
1-1/2	1.900	7	8	–	–	–
2	2.375	7	8	9	–	–
2-1/2	2.875	8	9	10	–	–
3	3.500	9	10	10	11	–
3-1/2	4.000	9	10	11	12	–
4	4.500	9	10	11	12	–
5	5.562	10	11	12	14	–
6	6.625	12	12	14	16	–
8	8.625	14	15	16	18	18
10	10.750	16	17	18	20	20
12	12.750	18	19	20	22	22

# Technical Section

## III. Eristrut Load Applications



# Technical Section

## III. Eristrut Load Applications

### CHANNEL FRAMING

Eristrut channel and continuous inserts are cold roll-formed from high quality carbon steel. The raw steel used conforms to the following ASTM® specifications:

Guage	Finish	ASTM No.
12, 14	GR, HD, PG	A1011 GR33 A653 GR33

### FINISHES

#### GREEN POWDER COATED (GN)

Eristrut green polyurethane powder coating is electrostatically applied after fabrication. Once the channel is pre-treated and cleaned, it is coated with the powder. It proceeds through a baking process creating a chemical bond, resulting in a 1.5 mil thickness of polyurethane coating. This coating provides excellent resistance to chipping, peeling, and corrosion.

#### PRE-GALVANIZED (PG)

The zinc coating on this channel is produced by hot dipping the steel coil or sheet at the mill prior to fabrication. This process is also known as "mill galvanized". The steel is then rolled and processed to produce various sizes and configurations of channel. During the fabrication of this product, the cut edges and welded areas are no longer zinc coated. However, the zinc near the uncoated metal provides sufficient protection to any bare areas. Pre-galvanized channel is suitable for use in dry or mildly corrosive atmospheres.

#### HOT DIP GALVANIZED (HD)

The zinc coating in this finish is applied after rolling and fabrication. The bond formed by dipping the finished product in molten zinc, completely covers all surfaces, including edges and welds. This zinc coating is recommended for prolonged outdoor exposure and will normally protect steel for up to 20 years or more. For best results, any field cuts should be treated with a zinc-rich paint to ensure the integrity of the finish.

#### STAINLESS STEEL (S4 OR S6)

Eristrut offers channel and accessories in AISI Type 304 of Type 316 stainless steel. Both are non magnetic. Stainless steel reduces long term maintenance costs, is ideal for use in extreme ambient temperatures and is resistant to corrosion.

#### ALUMINUM (AL)

Aluminum channel offers low installation costs through ease of handling and field cutting, while providing excellent corrosion resistance. All aluminum channels are extruded from aluminum alloy 6063-T6. Strut fittings are made from aluminum alloy 5052-H32.

#### PLAIN (PL)

The plain finish designation means that the channel retains the oiled surface applied to the steel prior to the rolling process. This channel offers no protection from corrosion.

#### ELECTRO-PLATED ZINC (EG)

The Electro-plated Zinc process deposits a coating of zinc over the steel by electrolysis from a bath of zinc sales. EG finish is usually recommended for indoor use in relatively dry areas. Unless otherwise noted, the standard finish for all Eristrut fittings and accessories is EG. This finish conforms with ASTM B633 SC1.

#### FITTINGS

Eristrut fittings, unless otherwise noted, are punch pressed from hot rolled, pickled and oiled steel plates, strip or coil, and conform to ASTM specifications A575, A576, A635 and A36. The pickling of the steel provides a smooth scale-free surface.

# Technical Section

## III. Eristrut Load Applications

### HARDWARE

Eristrut's Channel nuts are designed to provide gripping power and ease during installation. Channel nuts are press formed, machined and hardened from steel that meets the requirements of ASTM A576, ASTM A675 and ASTM A108. Standard finish is electro-plated zinc (ASTM B663).

Channel nuts are rectangular with beveled end to permit quarter turn in the channel after insertion through the rolled opening. Toothed grooves engage the rolled edges of the channel and prevent movement of the nut after tightening of the bolt and nut. All bolts, screws and nuts meet the physical and chemical requirements of ASTM A307, SAE J429 and ASTM A563, as well as having unified inch screw threads (course, UNC). Metric threads are also available.

### USING ERISTRUT LOAD TABLES

The calculation for beam loading on a piece of strut or a simply supported beam with a uniformly distributed load is based on the following equations taken from "Machinery's Handbook, 26th edition":

Stress at center (worst case) =

$$[\text{eq. 1}] \quad - \frac{WL}{8Z}$$

Maximum deflection at center =

$$[\text{eq. 2}] \quad \frac{5}{384} * \frac{WL^3}{EI}$$

W = Load value evenly distributed over the strut (maximum supplied by the manufacturer)

Z = Section modulus (calculated or supplied by the manufacturer)

E = Modulus of elasticity of the material  
(29,000,000 psi for commercial grade steel)

I = Moment of inertia of the cross section of the strut (calculated or supplied by the manufacturer)

L = Length of strut

### SELECTING THE ERISTRUT PROFILE

Typically the capacity ratings for strut are listed for an evenly distributed load as shown above. Although this case may be rare for pipe support applications, it does provide a baseline from which the acceptable load for a given piping layout can be obtained. The figures listed in the load tables are based on a yield stress rating for steel. Eristrut uses 25,000 psi as the maximum stress allowed in the strut member.

The most commonly asked question concerning beam design for strut is how are the loads calculated if a point load or several point loads are applied instead of a uniformly distributed load. This can be derived from the supplied information using simple

conversion numbers derived from the formulas in "Machinery's Handbook". A sample of the calculation used for the listed, evenly distributed load and a single-point load is shown in the next equation.

Point load stress =

$$\frac{WL}{4Z}$$

Evenly distributed load stress =

$$\frac{WL}{8Z}$$

Point Load Stress =  
Evenly distributed load stress

$$\frac{1}{2} = 0.50$$

# Technical Section

## III. Eristrut Load Applications

The comparison formula shows the stress is doubled and the allowable load cut in half when applying a point load instead of an evenly distributed load. This is case 2 on the Loading Application Tables. Other load factors are also shown. Simply apply the load factor for the appropriate case to the maximum loads shown in the catalog to obtain the maximum load for the situation. The load used in the calculation should include a factor of safety appropriate for the application in which the strut is being used.

Consider an applied load of 250 lb. (AL) as a point load to the center of a 24-in. section of strut. Assume that the strut has half slots and the

required factor of safety (FS) is 3. First, determine the appropriate hole factor (HF) and load factor (LF) from the Load Application Table. Then calculate the design load.

$$\text{Design Load} = \frac{AL * FS}{LF * HF} = \frac{250 \text{ lb.} * 3}{0.5 * 0.9} = 1667 \text{ lb.}$$

Next, in the load tables, find the strut section which has a uniform load rating higher than the design load for a 24 inch section. Note that A12 allows 1692 lb. for a 24 inch section. If no strut sections will support the design load, a different support configuration may need to be selected.

## DEFLECTION CALCULATIONS

The maximum allowable deflection is based on an industry standard of the length of the member divided by 240. For a 24-in. section of channel, this would yield an allowable

deflection of 0.10-in. These values are listed in the load tables. (For A12 strut, the deflection for a simply supported beam with uniform load of 250 lb. using equation 2 is:

$$\text{Uniform Load Deflection (ULD)} = \frac{5}{384} * \frac{WL^3}{EI} = \frac{5 * 250 \text{ lb.} * (24 \text{ in.})^3}{384 * 29,000,000 \text{ lb. in.}^2 * 0.188 \text{ in.}^4} = 0.008 \text{ in.}$$

In order to determine the deflection for other loading cases, multiply the deflection amount for the uniform loading case by the deflection factor found in the Load Application Chart.

An allowance must be made for channel that is punched with slots or holes. For a simply supported beam with full slots and a concentrated load in the center of the span, where:

$$\text{Deflection} = \text{ULD} * \text{DF} \div \text{HF} = \frac{0.008 \text{ in.} * 1.6}{0.90} = 0.014 \text{ in.}$$

$$\text{Allowable Deflection} = \frac{L}{240} = \frac{24 \text{ in.}}{240} = 0.10 \text{ in.}$$

Note that this deflection is within the recommended range. If it is not, another beam or another support configuration should be selected.

ULD = Uniform Load Deflection (see calculation pg. 370)

DF = Deflection Factor (see Table pg. 370-372)

HF = Hole Factor (see Table pg. 372)

LF = Load Factor (see Table pg. 370-372)



# Technical Section

## III. Eristrut Load Applications

### FACTOR OF SAFETY CALCULATIONS

Eristrut uses 25,000 psi as the maximum stress allowed in the strut member. Considering a 1-5/8" X 1-5/8" piece of 12 gauge channel

(Eristrut Model A12) two (2) feet in length with an applied load of 250 lb. Using Equation 1 we find the values of:

$$\text{Stress} = \frac{WL}{8Z} = \frac{250 \text{ lb.} * 24 \text{ in.}}{8 * 0.203 \text{ in.}^3} = 3695 \text{ psi.}$$

Since our example is for a point load, the stress will be doubled per the Load Application Chart.

$$\text{Factor of Safety} = \frac{\text{LF} * \text{HF} * 25,000 \text{ psi.}}{\text{Actual Stress}} = \frac{0.5 * 0.9 * 25,000}{3695} = 3$$



The figures on these pages illustrate the load applications and the derived conversion factors. These factors multiplied by the load ratings listed

on pages 268-274 will give the maximum recommended load in that application for the type of Eristrut being used.

Loading Application	Load Factor (LF)	Deflection Factor (DF)
Simple beam with a uniformly applied load and supported at each end.	1.00	1.00
Simple beam with a concentrated load at center and supported at each end.	0.50	1.60
Simple beam with 2 equal concentrated loads at 1/4 total length from ends and supported at each end.	1.00	1.10
Beam fixed at both ends with a uniformly applied load	1.50	0.20
Beam fixed at both ends with a concentrated load at center	1.00	0.40

# Technical Section

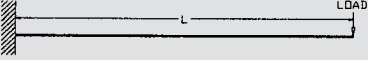
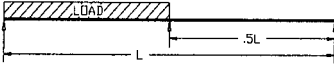
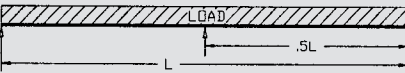
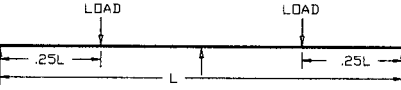
## III. Eristrut Load Applications

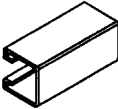
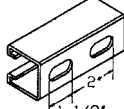
Loading Application	Load Factor (LF)	Deflection Factor (DF)
Cantilever Beam with a uniform load.	0.25	9.60
		
Cantilever beam with a concentrated load at the end or at any point along the length.	0.12	25.60
		
Continuous beam over 2 equal spans with a uniform load on one span.	1.30	0.71
		
Continuous beam over 2 equal spans with a uniform load on both spans.	1.00	0.42
		
Continuous beam over 2 equal spans with a concentrated load at the center of both spans.	0.67	0.72
		
A beam supported at both ends with a concentrated load at distance "A" from the end.	$\frac{L^2}{8 * A * B}$	Contact nVent
		
A beam supported at both ends with 2 symmetrical loads each the same distance from each end.	$\frac{2 * L}{8 * A}$	Contact nVent
		
	Hole Type	Hole Factor (HF)
None/ Solid	1.00	
	Hole Type	Hole Factor (HF)
None/ Solid	0.85	

# Technical Section

## III. Eristrut Load Applications

### ERISTRUT CHANNEL

Model No.	Width (In.)	Height (In.)	Gauge
A12	1-5/8	1-5/8	12
A14	1-5/8	1-5/8	14
C12	1-5/8	13/16	12
C14	1-5/8	13/16	14
D12	1-5/8	2-7/16	12
E12	1-5/8	3-1/4	12

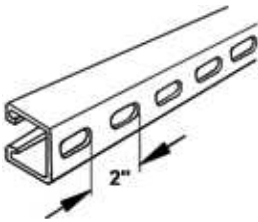

#### HALF SLOT (H)

1-1/8" x 9/16" slots,  
punched 2" on center

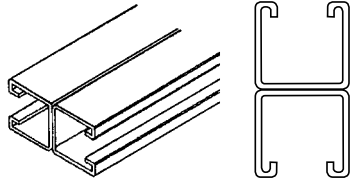

#### WELDED

Two lengths spot  
welded together.  
(Available only in the  
configuration above)

**BEAM LOADS** – Loads listed are uniformly distributed.  
When deflection is not a factor, use stress of 25,000 psi  
When deflection is a factor, use deflection of  $\frac{\text{span}}{240}$

**COLUMN LOADS** – Loads listed are allowable axial loads applied at the section centroid and are based upon an effective length factor  $K = 0.8$ , standard engineering practice required for evaluation of other conditions. Loads applied at the slot face must be reduced for eccentricity.

**NOTE:** Must specify length, finish, and hole configuration when ordering

# Technical Section

## III. Eristrut Load Applications

### ERISTRUT CHANNEL: A12

#### ELEMENTS OF SECTION

Weight lbs/ft	Area of Section in <sup>2</sup>	Axis x-x			Axis y-y		
		I (in <sup>4</sup> )	Z (in <sup>3</sup> )	r (in)	I (in <sup>4</sup> )	Z (in <sup>3</sup> )	r (in)
1.88	.553	.182	.199	.574	.234	.289	.651

I = moment of inertia                      Z = section modulus                      r = radius of gyration

#### BEAM AND COLUMN LOADS DATA

BEAM SPAN or Unbraced Column Height (inches)	UNIFORM LOAD at Stress of 25,000 psi (lbs.)	DEFLECTION at Stress of 25,000 psi (lbs.)	UNIFORM LOAD (lbs.) when Maximum Deflection = <u>span</u> 240	Maximum Allowable Load of Column (lbs.)
18	2211	.032	2211	9481
24	1658	.057	1658	8582
30	1327	.088	1327	7601
36	1106	.127	1106	6595
42	948	.173	948	5595
48	829	.226	733	4718
54	737	.286	579	4090
60	633	.337	469	3616
72	553	.509	326	2936
84	474	.693	239	2461
96	415	.906	183	2101
108	369	1.147	145	1816
120	332	1.415	117	1583 **

\*\*  $\frac{KL}{r}$  exceeds 200

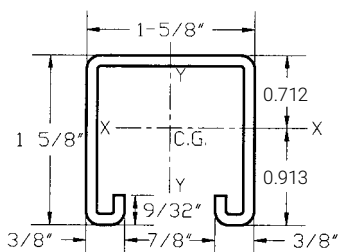

# Technical Section

## III. Eristrut Load Applications

### ERISTRUT CHANNEL: A12A

ELEMENTS OF SECTION							
Weight lbs/ft	Area of Section in <sup>2</sup>	Axis x-x			Axis y-y		
		I (in <sup>4</sup> )	Z (in <sup>3</sup> )	r (in)	I (in <sup>4</sup> )	Z (in <sup>3</sup> )	r (in)
3.76	1.105	.925	.569	.915	.469	.577	.651

I = moment of inertia      Z = section modulus      r = radius of gyration

BEAM AND COLUMN LOADS DATA				
BEAM SPAN or Unbraced Column Height (inches)	UNIFORM LOAD at Stress of 25,000 psi (lbs.)	DEFLECTION at Stress of 25,000 psi (lbs.)	UNIFORM LOAD (lbs.) when Maximum Deflection = $\frac{\text{span}}{240}$	Maximum Allowable Load of Column (lbs.)
18	2550*	.007	2550*	21239
24	2550*	.017	2550*	20819
30	2550*	.033	2550*	20279
36	2550*	.058	2550*	19619
42	2550*	.092	2550*	18840
48	2371	.127	2371	17940
54	2107	.161	2107	16920
60	1897	.199	1897	15781
72	1581	.286	1581	13141
84	1355	.390	1217	10076
96	1185	.509	931	7715
108	1054	.644	736	6096
120	948	.795	596	4937**

\* Load limited by spot weld shear

\*\*  $\frac{KL}{r}$  exceeds 200

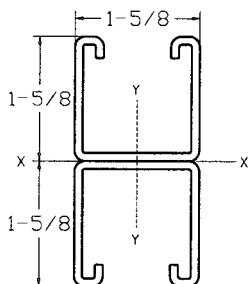

# Technical Section

## III. Eristrut Load Applications

### ERISTRUT CHANNEL: A14

#### ELEMENTS OF SECTION

Weight lbs/ft	Area of Section in <sup>2</sup>	Axis x-x			Axis y-y		
		I (in <sup>4</sup> )	Z (in <sup>3</sup> )	r (in)	I (in <sup>4</sup> )	Z (in <sup>3</sup> )	r (in)
1.40	.412	.145	.161	.592	.180	.221	.661

I = moment of inertia      Z = section modulus      r = radius of gyration

#### BEAM AND COLUMN LOADS DATA

BEAM SPAN or Unbraced Column Height (inches)	UNIFORM LOAD at Stress of 25,000 psi (lbs.)	DEFLECTION at Stress of 25,000 psi (lbs.)	UNIFORM LOAD (lbs.) when Maximum Deflection = <u>span</u> 240	Maximum Allowable Load of Column (lbs.)
18	1789	.032	1789	6058
24	1342	.057	1342	5483
30	1073	.090	1073	4958
36	894	.129	894	4302
42	767	.176	763	3571
48	671	.230	584	3008
54	596	.291	461	2488
60	537	.359	374	2200
72	477	.517	260	1740
84	383	.703	191	1444
96	335	.918	146	1236
108	298	1.162	115	1078
120	268	1.434	93	953**

\*\*  $\frac{KL}{r}$  exceeds 200

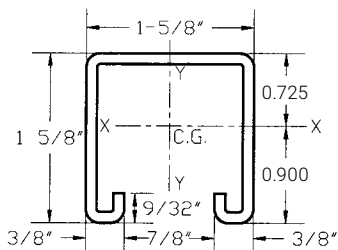

# Technical Section

## III. Eristrut Load Applications

### ERISTRUT CHANNEL: C12

#### ELEMENTS OF SECTION

Weight lbs/ft	Area of Section in <sup>2</sup>	Axis x-x			Axis y-y		
		I (in <sup>4</sup> )	Z (in <sup>3</sup> )	r (in)	I (in <sup>4</sup> )	Z (in <sup>3</sup> )	r (in)
1.32	.375	.030	.062	.282	.140	.172	.600

I = moment of inertia                      Z = section modulus                      r = radius of gyration

#### BEAM AND COLUMN LOADS DATA

BEAM SPAN or Unbraced Column Height (inches)	UNIFORM LOAD at Stress of 25,000 psi (lbs.)	DEFLECTION at Stress of 25,000 psi (lbs.)	UNIFORM LOAD (lbs.) when Maximum Deflection = $\frac{\text{span}}{240}$	Maximum Allowable Load of Column (lbs.)
18	689	.060	689	7204
24	517	.107	483	6521
30	413	.167	309	4167
36	344	.240	215	3616
42	295	.327	158	2415
48	258	.427	121	2034
54	230	.542	95	1473
60	207	.669	77	1302**
72	172	.961	54	904**
84	148	1.313	39	664**
96	129	1.708	30	-
108	115	2.168	24	-
120	103	2.664	19	-

\*\*  $\frac{KL}{r}$  exceeds 200

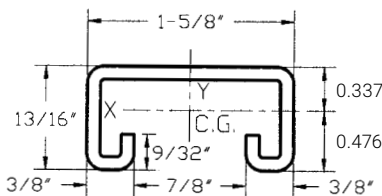

# Technical Section

## III. Eristrut Load Applications

### ERISTRUT CHANNEL: C14

#### ELEMENTS OF SECTION

Weight lbs/ft	Area of Section in <sup>2</sup>	Axis x-x			Axis y-y		
		I (in <sup>4</sup> )	Z (in <sup>3</sup> )	r (in)	I (in <sup>4</sup> )	Z (in <sup>3</sup> )	r (in)
.99	.290	.025	.053	.295	.107	.132	.607

I = moment of inertia

Z = section modulus

r = radius of gyration

#### BEAM AND COLUMN LOADS DATA

BEAM SPAN or Unbraced Column Height (inches)	UNIFORM LOAD at Stress of 25,000 psi (lbs.)	DEFLECTION at Stress of 25,000 psi (lbs.)	UNIFORM LOAD (lbs.) when Maximum Deflection = $\frac{\text{span}}{240}$	Maximum Allowable Load of Column (lbs.)
18	589	.062	589	5488
24	442	.110	403	4968
30	353	.171	258	3545
36	294	.246	179	3076
42	252	.335	132	2053
48	221	.439	101	1730
54	196	.554	80	1252
60	177	.687	64	1107**
72	147	.985	45	769**
84	126	1.341	33	565**
96	110	1.748	25	-
108	98	2.217	20	-
120	88	2.731	16	-

\*\*  $\frac{KL}{r}$  exceeds 200

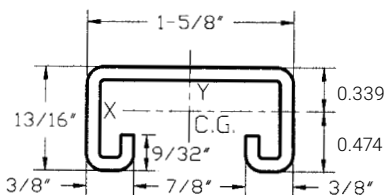



# Technical Section

## III. Eristrut Load Applications

### ERISTRUT CHANNEL: D12

#### ELEMENTS OF SECTION

Weight lbs/ft	Area of Section in <sup>2</sup>	Axis x-x			Axis y-y		
		I (in <sup>4</sup> )	Z (in <sup>3</sup> )	r (in)	I (in <sup>4</sup> )	Z (in <sup>3</sup> )	r (in)
2.46	.723	.516	.388	.845	.333	.410	.679

I = moment of inertia

Z = section modulus

r = radius of gyration

#### BEAM AND COLUMN LOADS DATA

BEAM SPAN or Unbraced Column Height (inches)	UNIFORM LOAD at Stress of 25,000 psi (lbs.)	DEFLECTION at Stress of 25,000 psi (lbs.)	UNIFORM LOAD (lbs.) when Maximum Deflection = $\frac{\text{span}}{240}$	Maximum Allowable Load of Column (lbs.)
18	4311	.022	4311	9533
24	3233	.039	3233	8629
30	2587	.061	2587	7821
36	2156	.088	2156	6786
42	1848	.119	1848	5680
48	1617	.156	1617	4785
54	1437	.197	1437	3984
60	1293	.243	1293	3523
72	1078	.350	924	2806
84	924	.477	679	2345
96	808	.622	520	2019
108	719	.788	411	1773
120	647	.973	333	1577

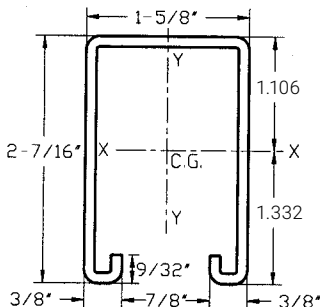

# Technical Section

## III. Eristrut Load Applications

### ERISTRUT CHANNEL: E12

#### ELEMENTS OF SECTION

Weight lbs/ft	Area of Section in <sup>2</sup>	Axis x-x			Axis y-y		
		I (in <sup>4</sup> )	Z (in <sup>3</sup> )	r (in)	I (in <sup>4</sup> )	Z (in <sup>3</sup> )	r (in)
3.040	.894	1.089	.624	1.104	.432	.532	.695

I = moment of inertia

Z = section modulus

r = radius of gyration

#### BEAM AND COLUMN LOADS DATA

BEAM SPAN or Unbraced Column Height (inches)	UNIFORM LOAD at Stress of 25,000 psi (lbs.)	DEFLECTION at Stress of 25,000 psi (lbs.)	UNIFORM LOAD (lbs.) when Maximum Deflection = $\frac{\text{span}}{240}$	Maximum Allowable Load of Column (lbs.)
18	6933	.017	6933	8598
24	5200	.030	5200	7783
30	4160	.046	4160	7495
36	3467	.067	3467	6503
42	2971	.091	2971	5921
48	2600	.119	2600	4988
54	2311	.150	2311	4066
60	2080	.185	2080	3595
72	1733	.267	1733	2790
84	1486	.363	1432	2291
96	1300	.474	1097	1953
108	1156	.600	866	1708
120	1040	.741	702	1522

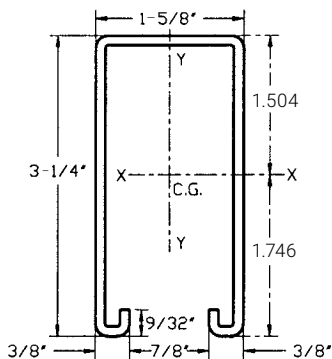

# Technical Section

## III. Eristrut Load Applications

### STRUT NUT PULL OUT STRENGTH

Thread Size	Part Number	Channel Size	12 GA (lbs)	14 GA (lbs)	16 GA (lbs)
#8 - 32	NUT, NUTC, SPRA, SPRC, SPRD	A, C, D, E,	200	200	200
#10 - 24	NUT, NUTC, SPRA, SPRC, SPRD	A, C, D, E,	250	250	250
1/4 - 20	NUT, NUTC, SPRA, SPRC, SPRD, TSNT	A, C, D, E,	450	450	450
5/16 - 18	NUT, NUTC, SPRA, SPRC, SPRD	A, C, D, E,	750	750	750
3/8 - 16	NUT, NUTC, SPRA, SPRC, SPRD, TSNT	A, C, D, E,	1100	1000	1000
1/2 - 13	NUT, NUTC, SPRA, SPRC, SPRD, TSNT	A, C,	2000	1400	1000
1/2 - 13	NUT, NUTC, SPRA, SPRC, SPRD, TSNT	D, E	1500	1400	1000
5/8 - 11	NUT, NUTC, SPRA, SPRC, SPRD	A, C,	2000	1400	1000
5/8 - 11	NUT, NUTC, SPRA, SPRC, SPRD	D, E	1500	1400	1000
3/4 - 10	NUT, NUTC, SPRA, SPRC, SPRD	A, C,	2000	1400	1000
3/4 - 10	NUT, NUTC, SPRA, SPRC, SPRD	D, E	1500	1400	1000
7/8 - 9	NUT, NUTC, SPRA, SPRC, SPRD	A, C,	2000	1400	1000
7/8 - 9	NUT, NUTC, SPRA, SPRC, SPRD	D, E	1500	1400	1000

# Grab some Popcorn and Check Out What's Happening on the nVent CADDY Channel.

Visit the nVent CADDY channel on YouTube® for the latest instructional 'how-to' videos, product testimonials and new product launches.

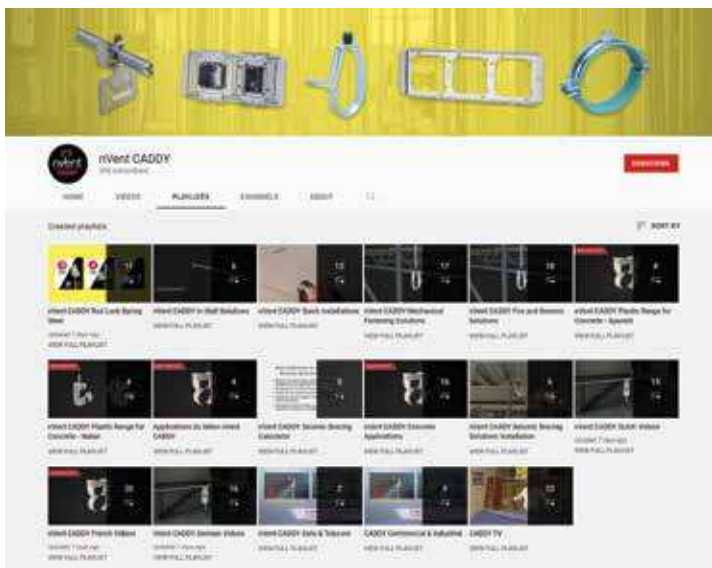

# Index

Part No.	Page	Part No.	Page	Part No.	Page
0070050EG	5-8	0120025EG	25-11	0425030EG	25-7
0070075EG	5-8	0120037EG	25-11	0431602EG	25-8
0070100EG	5-8	0120050EG	25-11	0470025PL	25-5
0070125EG	5-8	0250025EG	25-3	0470037PL	25-5
0070150EG	5-8	0250037EG	25-3	0470050PL	25-5
0070200EG	5-8	0250050EG	25-3	0502506EG	25-2
0080050EG	5-8	0250062EG	25-3	0502510EG	25-2
0080075EG	5-8	0250075EG	25-3	0503706EG	25-2
0080100EG	5-8	0250087EG	25-3	0503710EG	25-2
0080125EG	5-8	025R3725EG	25-3	0503712EG	25-2
0080150EG	5-8	025R5037EG	25-3	0505006EG	25-2
0080200EG	5-8	025R6250EG	25-3	0505010EG	25-2
0080250EG	5-8	0260037PL	25-4	0505012EG	25-2
0080300EG	5-8	0260050PL	25-4	0506206EG	25-2
0080400EG	5-8	0260062PL	25-4	0506210EG	25-2
0100025EG	25-10	0260075PL	25-4	0506212EG	25-2
0100025PL	25-10	0350037PL	25-4	0507506EG	25-2
0100037EG	25-10	035RS0600EG	9-10	0507510EG	25-2
0100037PL	25-10	035RS0800EG	9-10	0507512EG	25-2
0100050EG	25-10	035RS1000EG	9-10	0508706EG	25-2
0100050PL	25-10	035RS1200EG	9-10	0508710EG	25-2
0100062EG	25-10	035RS1400EG	9-10	0513702PL	25-2
0100062PL	25-10	035RS1600EG	9-10	2EBN	25-6
0100075EG	25-10	035RS1800EG	9-10	2H4	9-11
0100075PL	25-10	0370037EG	9-20	3TW	6-4
0100087EG	25-10	0370050EG	9-20	4EBN	25-6
010H0037EG	25-10	0380037EG	9-20	4H1318	9-11
010H0050EG	25-10	0413704PL	25-7	4H24	9-11
010H0062EG	25-10	0413706PL	25-7	4H24SS	9-11
010H0075EG	25-10	0413708PL	25-7	4H58	9-11
010H0087EG	25-10	0413710PL	25-7	4H58SS	9-11
0110025EG	25-11	0415004PL	25-7	4H912	9-11
0110025PL	25-11	0415006PL	25-7	4H912SS	9-11
0110037EG	25-11	0415008PL	25-7	4QCN	27-16
0110037PL	25-11	0422515EG	25-7	4QTI	17-20
0110050EG	25-11	0422520EG	25-7	4QTI24	17-4
0110050PL	25-11	0423715EG	25-7	4QTI58	17-4
0110062EG	25-11	0423720EG	25-7	4QTI912	17-4
0110062PL	25-11	0423725EG	25-7	4QTIAFAB3	17-24
0110075EG	25-11	0423730EG	25-7	4QTIB	17-20
0110075PL	25-11	0425020EG	25-7	4QTIBC	17-6
0110087EG	25-11	0425025EG	25-7	4QTIBSF	17-21

# Index

Part No.	Page	Part No.	Page	Part No.	Page
4QTIGBSF	17-22	100T0200EG	2-2	150M1200S4	5-10
4QTIO	17-23	100T0250EG	2-2	200RS375	9-9
4TI	17-17	100T0300EG	2-2	200RS500	9-9
4TI24	17-3	100T0350EG	2-2	304B2	15-2
4TI58	17-3	100T0400EG	2-2	355N0037EG	12-2
4TI912	17-3	122	9-15	355N0037PL	12-2
4TIAFAB3	17-19	123	9-16	355N0050EG	12-2
4TIB	17-17	150M0100EG	5-10	355N0050PL	12-2
4TIBGBSF	17-18	150M0100PL	5-10	365M0037CP	11-5
4TIBSF	17-18	150M0100S4	5-10	365M0037EG	11-5
4TIO	17-19	150M0125EG	5-10	365M0037PL	11-5
4TW	25-6	150M0125PL	5-10	365M0050CP	11-5
5QCN	27-16	150M0125S4	5-10	365M0050EG	11-5
6A	17-11	150M0150EG	5-10	365M0050PL	11-5
6A24	17-5	150M0150PL	5-10	370A0037PL	12-3
6A58	17-5	150M0150S4	5-10	370A0050PL	12-3
6A912	17-5	150M0200EG	5-10	370A0062PL	12-3
6AB	17-12	150M0200PL	5-10	515	16-2
6AFAB3	17-13	150M0200S4	5-10	515A	16-2
6AO	17-12	150M0250EG	5-10	515AWHA	16-2
6ASF	17-11	150M0250PL	5-10	708	17-13
6QCN	27-16	150M0250S4	5-10	708AB	17-15
6T	17-17	150M0300EG	5-10	708AFAB3	17-16
6TA24	17-3	150M0300PL	5-10	708AO	17-16
6TA58	17-3	150M0300S4	5-10	708GBSF	17-15
6TA912	17-3	150M0400EG	5-10	708SF	17-14
6TAFAB3	17-19	150M0400PL	5-10	740	25-12
6TB	17-17	150M0400S4	5-10	1224TI	17-7
6TI	17-17	150M0500EG	5-10	1226A	17-6
6TI24	17-3	150M0500PL	5-10	1226T	17-7
6TI58	17-3	150M0500S4	5-10	1226TI	17-7
6TI912	17-3	150M0600EG	5-10	70824	17-5
6TIAFAB3	17-19	150M0600PL	5-10	70858	17-5
6TIB	17-17	150M0600S4	5-10	122708	17-7
6TIBGBSF	17-18	150M0800EG	5-10	389001	5-4
6TIBSF	17-18	150M0800PL	5-10	389002	5-4
6TIO	17-19	150M0800S4	5-10	389003	5-4
6TO	17-19	150M1000EG	5-10	389004	5-4
6W	25-6	150M1000PL	5-10	389005	5-4
8QCN	27-16	150M1000S4	5-10	389006	5-4
100A0050EGP100	2-4	150M1200EG	5-10	389007	5-4
100N0037EGSP100	2-4	150M1200PL	5-10	389008	5-4

# Index

Part No.	Page	Part No.	Page	Part No.	Page
389009	5-4	1010200CP	2-3	1150150EG	2-5
389011	5-4	1010250CP	2-3	1150150FL	2-6
389012	5-4	1010300CP	2-3	1150200EG	2-5
389013	5-4	1010400CP	2-3	1150200FL	2-6
389014	5-4	1040100EG	2-3	1150250EG	2-5
389015	5-5	1040200EG	2-3	1150250FL	2-6
389017	5-4	1050050S4	2-4	1150300EG	2-5
389018	5-4	1050075S4	2-4	1150300FL	2-6
389071	5-5	1050100S4	2-4	1150350EG	2-5
454001	3-3	1050125S4	2-4	1150400EG	2-5
454002	3-3	1050150S4	2-4	1150400FL	2-6
454003	3-3	1050200S4	2-4	1150500EG	2-5
454004	3-3	1050250S4	2-4	1150600EG	2-5
454005	3-3	1050300S4	2-4	1150800EG	2-5
454006	3-3	1050350S4	2-4	1160100EP	2-7
454007	3-3	1050400S4	2-4	1160125EP	2-7
454008	3-3	1050500S4	2-4	1160150EP	2-7
454009	3-3	1050600S4	2-4	1160200EP	2-7
454010	3-3	1050800S4	2-4	1160250EP	2-7
454011	3-3	1070075EG	6-2	1160300EP	2-7
454012	3-3	1070100EG	6-2	1160400EP	2-7
454013	3-3	1070125EG	6-2	1160500EP	2-7
454014	3-3	1070150EG	6-2	1160600EP	2-7
454015	3-3	1070200EG	6-2	1160800EP	2-7
454016	3-3	1080075EG	6-2	1250150EG	13-4
454017	3-3	1080100EG	6-2	1250200EG	13-4
708912	17-5	1080125EG	6-2	1250250EG	13-4
1190200	13-2	1080150EG	6-2	1250300EG	13-4
1190250	13-2	1080200EG	6-2	1250350EG	13-4
1190300	13-2	1090075EG	6-3	1250400EG	13-4
1190350	13-2	1090100EG	6-3	1250500EG	13-4
1190400	13-2	1090125EG	6-3	1250600EG	13-4
1190500	13-2	1090150EG	6-3	1250800EG	13-4
1190600	13-2	1090200EG	6-3	1251000EG	13-4
1000500EG	2-2	1150050EG	2-5	1251200EG	13-4
1000600EG	2-2	1150050FL	2-6	1450037EG	26-8
1000800EG	2-2	1150075EG	2-5	1450050EG	26-8
1010050CP	2-3	1150075FL	2-6	2000037EG	9-8
1010075CP	2-3	1150100EG	2-5	3000037EG	9-2
1010100CP	2-3	1150100FL	2-6	3000037PL	9-2
1010125CP	2-3	1150125EG	2-5	3000050EG	9-2
1010150CP	2-3	1150125FL	2-6	3000050PL	9-2

# Index

Part No.	Page	Part No.	Page	Part No.	Page
3000062EG	9-2	4010100EG	1-2	4030300EG	1-4
3000062PL	9-2	4010100HD	1-3	4030350EG	1-4
3000075EG	9-2	4010125EG	1-2	4030400EG	1-4
3000075PL	9-2	4010125HD	1-3	4030500EG	1-4
3000087EG	9-2	4010150EG	1-2	4030600EG	1-4
3000087PL	9-2	4010150HD	1-3	4030800EG	1-4
3050037S4	9-4	4010200EG	1-2	4031000EG	1-4
3050050S4	9-4	4010200HD	1-3	4031200EG	1-4
3100037EG	9-3	4010250EG	1-2	4060050S4	1-5
3100037PL	9-3	4010250HD	1-3	4060075S4	1-5
3100050EG	9-3	4010300EG	1-2	4060100S4	1-5
3100050PL	9-3	4010300HD	1-3	4060125S4	1-5
3150037EG	9-15	4010350EG	1-2	4060150S4	1-5
3150037PL	9-15	4010400EG	1-2	4060200S4	1-5
3250037EG	9-18	4010400HD	1-3	4060250S4	1-5
3250037PL	9-18	4010500EG	1-2	4060300S4	1-5
3250050EG	9-18	4010500HD	1-3	4060350S4	1-5
3250050PL	9-18	4010600EG	1-2	4060400S4	1-5
3270037EG	9-18	4010600HD	1-3	4060500S4	1-5
3270037PL	9-18	4010800EG	1-2	4060600S4	1-5
3270050EG	9-18	4010800HD	1-3	4060800S4	1-5
3270050PL	9-18	4011000EG	1-2	4061000S4	1-5
3280037EG	9-19	4011000HD	1-3	4061200S4	1-5
3280037PL	9-19	4011200EG	1-2	4100050EG	1-6
3280050PL	9-19	4011200HD	1-3	4100075EG	1-6
3290037EG	9-19	4011400EG	1-2	4100100EG	1-6
3520100PL	11-6	4011600EG	1-2	4100125EG	1-6
3520200PL	11-6	4011800EG	1-2	4100150EG	1-6
3520300PL	11-6	4012000EG	1-2	4100200EG	1-6
3550000EG	12-2	4012400EG	1-2	4100250EG	1-6
3550000PL	12-2	4020050CP	1-3	4100300EG	1-6
3600037PL	9-11	4020075CP	1-3	4100350EG	1-6
3600050PL	9-11	4020100CP	1-3	4100400EG	1-6
3600062PL	9-11	4020125CP	1-3	4100500EG	1-6
3600075PL	9-11	4020150CP	1-3	4100600EG	1-6
3600087PL	9-11	4020200CP	1-3	4100800EG	1-6
3650037EG	11-5	4020250CP	1-3	4290050EG	3-4
3650037PL	11-5	4020300CP	1-3	4290075EG	3-4
4010050EG	1-2	4020400CP	1-3	4290100EG	3-4
4010050HD	1-3	4030150EG	1-4	4290125EG	3-4
4010075EG	1-2	4030200EG	1-4	4290150EG	3-4
4010075HD	1-3	4030250EG	1-4	4290200EG	3-4



# Index

Part No.	Page	Part No.	Page	Part No.	Page
4290250EG	3-4	4560300CP	3-6	5101600EG	4-3
4290300EG	3-4	4560400CP	3-6	5101800EG	4-3
4290350EG	3-4	5100050EG	4-3	5102000EG	4-3
4290400EG	3-4	5100050HD	4-3	5102400EG	4-3
4290500EG	3-4	5100050S4	4-2	5110050CP	4-4
4300050EG	3-2	5100075EG	4-3	5110075CP	4-4
4300075EG	3-2	5100075S4	4-2	5110100CP	4-4
4300100EG	3-2	5100100EG	4-3	5110125CP	4-4
4300125EG	3-2	5100100HD	4-3	5110150CP	4-4
4300150EG	3-2	5100100S4	4-2	5110200CP	4-4
4300200EG	3-2	5100125EG	4-3	5110250CP	4-4
4300250EG	3-2	5100125HD	4-3	5110300CP	4-4
4300300EG	3-2	5100125S4	4-2	5110400CP	4-4
4300350EG	3-2	5100150EG	4-3	5120100EG	4-4
4300400EG	3-2	5100150HD	4-3	5120125EG	4-4
4300500EG	3-2	5100150S4	4-2	5120150EG	4-4
4550050EG	3-5	5100200EG	4-3	5120200EG	4-4
4550050PL	3-5	5100200HD	4-3	5120250EG	4-4
4550075EG	3-5	5100200S4	4-2	5120300EG	4-4
4550075PL	3-5	5100250EG	4-3	5120400EG	4-4
4550100EG	3-5	5100250HD	4-3	5120600EG	4-4
4550100PL	3-5	5100250S4	4-2	5200050EP	4-6
4550125EG	3-5	5100300EG	4-3	5200075EP	4-6
4550125PL	3-5	5100300HD	4-3	5200100EP	4-6
4550150EG	3-5	5100300S4	4-2	5200125EP	4-6
4550150PL	3-5	5100350EG	4-3	5200150EP	4-6
4550200EG	3-5	5100400EG	4-3	5200200EP	4-6
4550200PL	3-5	5100400HD	4-3	5200250EP	4-6
4550250EG	3-5	5100400S4	4-2	5200300EP	4-6
4550250PL	3-5	5100500EG	4-3	5200400EP	4-6
4550300EG	3-5	5100500HD	4-3	5200500EP	4-6
4550300PL	3-5	5100500S4	4-2	5200600EP	4-6
4550400EG	3-5	5100600EG	4-3	6050600HD	14-2
4550400PL	3-5	5100600HD	4-3	6050800HD	14-2
4560037CP	3-6	5100600S4	4-2	6051000HD	14-2
4560050CP	3-6	5100800EG	4-3	6051200HD	14-2
4560075CP	3-6	5100800HD	4-3	6051400HD	14-2
4560100CP	3-6	5100800S4	4-2	6051600HD	14-2
4560125CP	3-6	5101000EG	4-3	6051800HD	14-2
4560150CP	3-6	5101000S4	4-2	6052000HD	14-2
4560200CP	3-6	5101200EG	4-3	6052400HD	14-2
4560250CP	3-6	5101400EG	4-3	6100300HD	14-3

# Index

Part No.	Page	Part No.	Page	Part No.	Page
6100350HD	14-3	6330300PL	13-12	A12AH100PG	27-8
6100400HD	14-3	6330350PL	13-12	A12AH200GN	27-8
6100500HD	14-3	6330500PL	13-12	A12AH200PG	27-8
6100600HD	14-3	6330800PL	13-12	A12H1000GN	27-7
6100800HD	14-3	6331000PL	13-12	A12H1000HD	27-7
6101000HD	14-3	6331600PL	13-12	A12H1000PG	27-7
6101200HD	14-3	6331800PL	13-12	A12H1000S4	27-7
6101400HD	14-3	6332000PL	13-12	A12H2000GN	27-7
6101600HD	14-3	6332400PL	13-12	A12H2000HD	27-7
6101800HD	14-3	6340200PL	13-14	A12H2000PG	27-7
6102000HD	14-3	6340250PL	13-14	A141000PG	27-7
6102400HD	14-3	6340300PL	13-14	A14H1000GN	27-7
6300150PL	13-6	6340350PL	13-14	A14H1000PG	27-7
6300350PL	13-6	6340500PL	13-14	A14H2000GN	27-7
6300500PL	13-6	6340800PL	13-14	A14H2000PG	27-7
6300600PL	13-6	6341000PL	13-14	A3308AP100	25-8
6300800PL	13-6	6341200PL	13-14	A927W001P100	19-21
6310150PL	13-8	6341400PL	13-14	A927W002P100	19-21
6310350PL	13-8	6341600PL	13-14	A927W003P100	19-21
6310500PL	13-8	6341800PL	13-14	A927W004P100	19-21
6310800PL	13-8	6342000PL	13-14	A927W005P100	19-21
6311000PL	13-8	6342400PL	13-14	A927W006P100	19-21
6311200PL	13-8	6350400PL	13-16	A927W007P100	19-21
6311400PL	13-8	6350500PL	13-16	A927W008P100	19-21
6311600PL	13-8	6350800PL	13-16	A927W009P100	19-21
6311800PL	13-8	6351000PL	13-16	A927W010P100	19-21
6312000PL	13-8	6351200PL	13-16	A927W011P100	19-21
6312400PL	13-8	6351600PL	13-16	A927W012P100	19-21
6320150PL	13-10	6351800PL	13-16	A927W013P100	19-21
6320350PL	13-10	6352000PL	13-16	A927W014P100	19-21
6320500PL	13-10	6352400PL	13-16	A927W016P100	19-21
6320800PL	13-10	800037050EP	5-9	A927W018P100	19-21
6321000PL	13-10	800050075EP	5-9	A927W019P100	19-21
6321200PL	13-10	800075100EP	5-9	A927W020P100	19-21
6321400PL	13-10	800100125EP	5-9	A927W021P100	19-21
6321600PL	13-10	801037050EP	5-9	A927W022P100	19-21
6321800PL	13-10	801050075EP	5-9	AB	11-3
6322000PL	13-10	801075100EP	5-9	AB375	11-3
6322400PL	13-10	801100125EP	5-9	ABGBSF	11-3
6330150PL	13-12	801125150EP	5-9	ABSF	11-2
6330200PL	13-12	801150000EP	5-9	ADK421	27-11
6330250PL	13-12	A121000PG	27-7	ADK421GN	27-11

# Index

Part No.	Page	Part No.	Page	Part No.	Page
ADK421GY	27-11	BH0050CP	3-6	CD0B37CP	5-7
ADK421RD	27-11	BH0075CP	3-6	CD0BCP	5-7
AF14	9-16	BH0100CP	3-6	CD0BCPNAM	10-4
AF144TI	17-9	C121000PG	27-9	CD0BTDH	10-4
AF146A	17-8	C12H1000GN	27-8	CD1B37CP	5-7
AF146T	17-9	C12H1000PG	27-8	CD1BCP	5-7
AF146TI	17-9	C12H2000GN	27-8	CD1BCPNAM	10-4
AF14708	17-8	C12H2000PG	27-8	CD1BTDH	10-4
AFAB3	11-4	C141000PG	27-9	CD2.5B37CP	5-7
AFAB4	11-4	C14H1000GN	27-8	CD2.5BCP	5-7
AFAB6	11-4	C14H1000PG	27-8	CD2.5BCPNAM	10-4
AO	11-4	C14H1000S4	27-8	CD2.5BTDH	10-4
BC	9-5	C14H2000GN	27-8	CD2B37CP	5-7
BC090900EG	9-10	C14H2000PG	27-8	CD2BCP	5-7
BC091200EG	9-10	C4TI24	17-4	CD2BCPNAM	10-4
BC091500EG	9-10	C4TI58	17-4	CD2BTDH	10-4
BC100000EG	9-6	C4TI912	17-4	CD3B37CP	5-7
BC101500EG	9-6	C6TI24	17-4	CD3BCP	5-7
BC110000EG	9-7	C6TI58	17-4	CD5B37CP	5-7
BC120000EG	9-7	C6TI912	17-4	CD5BCP	5-7
BC130025EG	9-7	CA0025EG	26-3	CFEB05	20-26
BC130037EG	9-7	CA0037EG	26-3	CL100000EG	27-12
BC130050EG	9-7	CA0050EG	26-3	CL100000PS	27-12
BC140037EG	9-8	CCC0025	7-8	CM24S	17-3
BC140050EG	9-8	CCC0037	7-8	CM58S	17-3
BC140062EG	9-8	CCC0050	7-8	CM912S	17-3
BC16A000EG	27-25	CCC0062	7-8	CONB122000PG	27-11
BC17A000EG	27-24	CCC0075	7-8	COPC0050CP	7-3
BC17D000EG	27-24	CCC0087	7-8	COPC0075CP	7-3
BC180037EG	27-26	CCC0100	7-8	COPC0100CP	7-3
BC200	9-5	CCC0112	7-8	COPC0125CP	7-3
BC200000EG	27-25	CCC0125	7-8	COPC0150CP	7-3
BC200CD0B	9-21	CCC0137	7-8	COPC0200CP	7-3
BC200CD1B	9-21	CCC0150	7-8	COPC0250CP	7-3
BC200CD2.5B	9-21	CCC0162	7-8	COPC0300CP	7-3
BC200CD2B	9-21	CCC0187	7-8	COPC0350CP	7-3
BC200CD3B	9-21	CCC0212	7-8	COPC0400CP	7-3
BC200CD4B	9-21	CCC0237	7-8	CPNAM	10-4
BC200CD5B	9-21	CCC0262	7-8	CRA36SS38L2	19-21
BC23A000EG	27-27	CCC0312	7-8	CRA36SS38L3	19-21
BC260025EG	9-3	CCC0412	7-8	CRA36SS38L4	19-21
BC400	9-5	CCC0450	7-8	CRAU24EB1C	19-20

# Index

Part No.	Page	Part No.	Page	Part No.	Page
CRAU24EB1CR2	19-20	CRLP237L26	8-12	CSB2W36URC12L10	22-5
CRAU24PW3J	19-20	CRLP237L38	8-12	CSB2W36URC12L20	22-5
CRAU24PW3JR2	19-20	CRLP237L50	8-12	CSB2W36URC58L10	22-5
CRAU24PW8S	19-20	CRLP250L14	8-12	CSB2W36URC58L20	22-5
CRAU24PW8SR2	19-20	CRLP250L18	8-12	CSB3346SB	19-22, 22-6
CRAU24TW1C	19-20	CRLP250L22	8-12	CSB36CBL	22-2
CRAU24TW1CR2	19-20	CRLP250L26	8-12	CSB36CBLSS	22-2
CRAU24TW2F	19-20	CRLP250L38	8-12	CSB36SLVB	22-3
CRAU24TW2FR2	19-20	CRLP250L50	8-12	CSB36SLVBSS	22-3
CRAU24TW3J	19-20	CRLS37EG	8-14	CSBBRP0100EG	23-2
CRAU24TW3JR2	19-20	CRLSL37EG	8-14	CSBBRP0125EG	23-2
CRAU24TW4G	19-20	CRLW37EG	8-8	CSBBRP0150EG	23-2
CRAU24TW4GR2	19-20	CRLW50EG	8-8	CSBBRP0200EG	23-2
CRAU26ST2F	19-20	CSB0100	21-9	CSBBSR1EG	23-2
CRAU26ST2FR2	19-20	CSB0125	21-9	CSBBSR2EG	23-3
CRAU26STCR2F	19-20	CSB0150	21-9	CSBBSR3EG	23-3
CRAU26STCR2FR2	19-20	CSB0200	21-9	CSBBS121836	22-6
CRAU26SW12C	19-20	CSB0250	21-9	CSBC48	19-22, 22-2
CRAU26SW12CR2	19-20	CSB0300	21-9	CSBCAB030037EG	26-2
CRLA37EG	8-5	CSB0400	21-9	CSBCAB037550EG	26-2
CRLA37EGR2	8-5	CSB0500	21-9	CSBCAB045050EG	26-2
CRLAKITA	8-5	CSB0600	21-9	CSBCAB047562EG	26-2
CRLB37EG	8-2	CSB0800	21-9	CSBCAB055050EG	26-2
CRLB50EG	8-3	CSB1000	21-9	CSBCAB055075EG	26-2
CRLC37EG	8-10	CSB1200	21-9	CSBCAB060062EG	26-2
CRLC37L1	8-10	CSB12CBL	22-2	CSBCAB062575EG	26-2
CRLD37BEG	8-11	CSB12CBLSS	22-2	CSBCAS025037EG	26-2
CRLJ37EG	8-4	CSB12SBHS	22-6	CSBCAS030050EG	26-2
CRLK37EG	8-9	CSB12SLVB	22-3	CSBCAS040050EG	26-2
CRLM37EG	8-6	CSB12SLVBSS	22-3	CSBCAS040062EG	26-2
CRLM50EG	8-6	CSB18CBL	22-2	CSBCAS050050EG	26-2
CRLMIP	8-7	CSB18CBLSS	22-2	CSBCAS050062EG	26-2
CRLN37EG	8-15	CSB18SLVB	22-3	CSBCAS050075EG	26-2
CRLP137L14	8-12	CSB18SLVBSS	22-3	CSBCS0100	24-2
CRLP137L18	8-12	CSB2W12URC12L10	22-5	CSBCS0125	24-2
CRLP137L22	8-12	CSB2W12URC12L20	22-5	CSBCS0150	24-2
CRLP137L26	8-12	CSB2W12URC38L10	22-5	CSBCS0200	24-2
CRLP137L38	8-12	CSB2W12URC38L20	22-5	CSBCS0250	24-2
CRLP150L14	8-12	CSB2W18URC12L10	22-5	CSBCS0300	24-2
CRLP237L14	8-12	CSB2W18URC12L20	22-5	CSBCS0350	24-2
CRLP237L18	8-12	CSB2W18URC38L10	22-5	CSBCS0400	24-2
CRLP237L22	8-12	CSB2W18URC38L20	22-5	CSBCS0500	24-2

# Index

Part No.	Page	Part No.	Page	Part No.	Page
CSBCS0600	24-2	CSBT2	6-5, 21-12	ESC4TI	27-32
CSBCS0800	24-2	CSBTS1	21-12	ESC6TI	27-32
CSBCS1000	24-2	CSBU1	21-7	ESG1	15-3
CSBCS1200	24-2	CSBU2	21-7	ESG1M	15-3
CSBHN50EG	21-13	CSBUB62EG	21-13	ESGFP	15-4
CSBLN50EG	21-13	CSBURC12	22-3	ESGP	15-3
CSBMA050050EG	21-5	CSBURC12SS	22-3	EZR0050	4-5
CSBMA050075EG	21-5	CSBURC34	22-3	EZR0075	4-5
CSBNPC12	22-4	CSBURC38	22-3	EZR0100	4-5
CSBNPC38	22-4	CSBURC38SS	22-3	EZR0125	4-5
CSBNPC58	22-4	CSBURC58	22-3	EZR0150	4-5
CSBQG0250EG	21-10	CSBURC58SS	22-3	EZR0200	4-5
CSBQG0300EG	21-10	CSBURC78	22-3	EZR0250	4-5
CSBQG0400EG	21-10	CSBURCR12	22-4	EZR0300	4-5
CSBQG0600EG	21-10	CSBURCR38	22-4	EZR0350	4-5
CSBQG0800EG	21-10	CSBURCR58	22-4	EZR0400	4-5
CSBQIKCL0100EG	21-10	CSBUS1	21-8	EZR0500	4-5
CSBQIKCL0125EG	21-10	CSBUS1PA	21-6	EZR0600	4-5
CSBQIKCL0150EG	21-10	CSBUS2	21-8	F090000EG	27-18
CSBQIKCL0200EG	21-10	CSBUS2PA	21-6	F130000EG	27-17
CSBQIKCLSN37EG	21-13	CTH037BC	9-12	F140000EG	27-17
CSBR1	21-11	CTH037TC	9-13	F150000EG	27-17
CSBR2	21-11	CTH050BC	9-12	F160000EG	27-17
CSBRS1	24-3	CTH050TC	9-13	F170000EG	27-17
CSBRS2	24-3	CTS04	14-9	F200000EG	27-18
CSBRS3	24-3	CTS10	14-9	F220000EG	27-18
CSBRS37EG	24-3	D121000PG	27-10	F230000EG	27-19
CSBRS4	24-3	D12H1000PG	27-9	F250000EG	27-19
CSBS1	21-2	D12H2000PG	27-9	F280000EG	27-20
CSBS1A	21-3	DH0100EG	2-8	F360000EG	27-18
CSBS2	21-2	DH0125EG	2-8	F370000EG	27-19
CSBS3	21-4	DH0150EG	2-8	HFRMHDW	19-8
CSBS4	21-4	DH0200EG	2-8	HMZE215	26-7
CSBS5	21-4	DH4TI	10-3	HMZE350	26-7
CSBSB50EG	21-13	DH6TI	10-3	HMZG160	26-4
CSBSBR50EG	21-13	DOSR075	6-3	HMZG315	26-6
CSBSH00375EG	24-2	DOSR100	6-3	HMZG365	26-7
CSBSH00500EG	24-2	E121000PG	27-10	HMZG470	26-4
CSBSH00625EG	24-2	E12H1000PG	27-10	HMZG471	26-5
CSBSH00750EG	24-2	E12H2000PG	27-10	HMZG650	26-6
CSBSN37EG	21-13	ENDCA120EG	27-12	HMZG730	26-7
CSBT1	6-5, 21-12	ESC4	27-32	HMZH475	26-5

# Index

Part No.	Page	Part No.	Page	Part No.	Page
HMZH476	26-5	MSR24	18-2	PCL90S6	19-15
HMZH665	26-6	MSR58	18-2	PCP36	19-18
HSCR3710EG	25-9	MSR912	18-2	PCT20	19-16
HSCR3712EG	25-9	MSS24	18-2	PCT30	19-16
HSCR3715EG	25-9	MSS58	18-2	PCT40	19-16
HSCR3720EG	25-9	MSS912	18-2	PCT50	19-16
HSCR5010EG	25-9	MSSSF	18-3	PCT60	19-16
HSCR5012EG	25-9	NUT0025EG	27-13	PEB	19-13
HSCR5015EG	25-9	NUT0037EG	27-13	PEC	19-13
INC8T5	27-27	NUT0050EG	27-13	PEH31	19-12
ISSP375	27-30	NUT0050S6	27-13	PEK4B	19-9
ISSPK	27-31	NUT0062EG	27-13	PEK6B	19-10
KA25H0150EG	27-17	P110000EG	27-28	PEKEF	19-11
KA25H0300EG	27-17	P110000HD	27-28	PFB1624	5-2
KA25H0450EG	27-17	P11SQ000EG	27-28	PFBC	5-3
KA25H0600EG	27-17	P130000EG	27-29	PFBNB	5-3
L100000EG	27-20	PAR0050HD	9-22	PH4	9-14
L110000EG	27-20	PAR0075HD	9-22	PH6	9-14
L120300EG	27-21	PAR0100HD	9-22	PH6FP	9-14
L180000EG	27-21	PAR0125HD	9-22	PHB	19-7
L190000EG	27-22	PAR0150HD	9-22	PHBR	19-7
L200000EG	27-22	PAR0200HD	9-22	PHK	19-8
L220000EG	27-22	PBU10	19-25	PHKR	19-8
L23U0000EG	27-23	PBU16	19-25	PHSW4	9-14
L441200EG	27-22	PBU6	19-25	PHSW6	9-14
L441600EG	27-22	PCB36	19-17	PHSW6FP	9-14
L460450EG	27-21	PCB36H20	19-17	PPRPS25H4	19-26
L470450EG	27-20	PCB36H30	19-17	PPRPS25H6	19-26
LA0025EG	26-3	PCB36H40	19-17	PRA3H12	19-6
LA0037EG	26-3	PCB36H50	19-17	PRA6H16	19-6
LA0050EG	26-3	PCB36H60	19-17	PRF2	19-5
M1318	17-2	PCB36X12	19-17	PRF3	19-5
M1318S	17-2	PCGK	19-18	PRF6	19-5
M24	17-2	PCL50S2	19-14	PRS2	19-6
M24S	17-2	PCL50S3	19-14	PRS3	19-6
M58	17-2	PCL50S4	19-14	PRS6	19-6
M58S	17-2	PCL50S5	19-14	PSA10CH13	19-3
M912	17-2	PCL50S6	19-14	PSA16AH18	19-3
M912S	17-2	PCL90S2	19-15	PSB24A	19-4
MFA4I	27-15	PCL90S3	19-15	PSB30A	19-4
MFA625	27-15	PCL90S4	19-15	PSB36A	19-4
MSP20	15-4	PCL90S5	19-15	PSB42A	19-4

# Index

Part No.	Page	Part No.	Page	Part No.	Page
PSB48A	19-4	RIGD0400S4	7-2	SCH6B	7-9
PSB60A	19-4	ROL10000EG	27-31	SCH72B	7-9
PSF10C	19-2	ROL11000EG	27-31	SCH8B	7-9
PSF10D	19-2	ROL12000EG	14-4	SFCLT	16-3, 24-4
PSF16C	19-2	ROL13034EG	14-6	SFCLTCF	16-3, 24-4
PSF16D	19-2	ROL13046EG	14-6	SFCLTCFS	16-3, 24-4
PSF6C	19-2	ROL13068EG	14-6	SFCLTE	16-3, 24-4
PTF10	19-24	ROL14000EG	14-7	SFCLTS	16-3, 24-4
PTF16	19-24	ROL15000EG	14-8	SGB16A	5-11
PTF1C	19-25	RPS50H4EG	19-19	SGB24A	5-11
PTF2C	19-25	RPS50H6EG	19-19	SK125I	7-10
PTF6	19-24	RPS50H6HD	19-19	SK12ALA	7-10
RA0037HD	9-21	RPSC24	19-12	SK165I	7-10
RA0050HD	9-21	RPSC25	19-12	SK16ALA	7-10
RA0075HD	9-21	RPSC34	19-11	SK205I	7-10
RA0100HD	9-21	RPSE1H	19-23	SK20ALA	7-10
RA0125HD	9-21	RPSE1H24	19-23	SK245I	7-10
RA0150HD	9-21	RPSE1H57	19-23	SK24ALA	7-10
RA0200HD	9-21	RPSE2H46	19-23	SK325I	7-10
RA0250HD	9-21	RPSE4H46	19-23	SK32ALA	7-10
RA0250HD	9-21	RS06	9-9	SK405I	7-10
RA0300HD	9-21	RS08	9-9	SK485I	7-10
RA0300HD	9-21	RS10	9-9	SK565I	7-10
RAWL3758	26-4	RS12	9-9	SK645I	7-10
RIGD0050EG	7-2	RS14	9-9	SK85I	7-10
RIGD0050S4	7-2	RS16	9-9	SK8ALA	7-10
RIGD0075EG	7-2	RS18	9-9	SLADCP	20-24
RIGD0075S4	7-2	S311924P100	25-9	SLADS	20-24
RIGD0100EG	7-2	S31199P100	25-9	SLAFAB3	20-25
RIGD0100S4	7-2	S3575BP100	25-8	SLC15L1000SP	20-23
RIGD0125EG	7-2	S3575BP50	25-8	SLC15L50MSP	20-23
RIGD0125S4	7-2	S3575DP100	25-8	SLC2L1000SP	20-23
RIGD0150EG	7-2	SBC037	9-4	SLC3L1000SP	20-23
RIGD0150S4	7-2	SCH12B	7-9	SLD15L10S	20-19
RIGD0200EG	7-2	SCH16B	7-9	SLD15L2S	20-19
RIGD0200S4	7-2	SCH20B	7-9	SLD15L5S	20-19
RIGD0250EG	7-2	SCH24B	7-9	SLD15QT250	20-20
RIGD0250S4	7-2	SCH32B	7-9	SLD15Y200	20-20
RIGD0300EG	7-2	SCH40B	7-9	SLD15Y300	20-20
RIGD0300S4	7-2	SCH48B	7-9	SLD15Y500	20-20
RIGD0350EG	7-2	SCH56B	7-9	SLD15Y800	20-20
RIGD0400EG	7-2	SCH64B	7-9	SLD2Y300	20-20

# Index

Part No.	Page	Part No.	Page	Part No.	Page
SLD2Y500	20-20	SLK15L3LP	20-8	SLK2L34H24	20-6
SLD2YH500	20-19	SLK15L3LPR2	20-8	SLK2L34H58	20-6
SLD2YH800	20-19	SLK15L3R2	20-7	SLK2L3AB	20-2
SLD3YH500	20-19	SLK15L3SE250	20-9	SLK2L3DH	20-5
SLD3YH800	20-19	SLK15L3SF	20-3	SLK2L3GBSF	20-4
SLDBK	20-25	SLK15L3T	20-11	SLK2L3LP	20-8
SLEB250	20-26	SLK15L3TR2	20-11	SLK2L3R2	20-7
SLEB375	20-26	SLK15L5	20-7	SLK2L3SE375	20-9
SLEBWS	20-26	SLK15L500PACK	20-21	SLK2L3SF	20-3
SLICK250	27-12	SLK15L50MPACK	20-21	SLK2L3WA6	20-10
SLICK375	27-12	SLK15L5AB	20-2	SLK2L5	20-7
SLICK500	27-12	SLK15L5DH	20-5	SLK2L5AB	20-2
SLJR200	20-22	SLK15L5LP	20-8	SLK2L5DH	20-5
SLK15L1	20-7	SLK15L5LPR2	20-8	SLK2L5LP	20-8
SLK15L10	20-7	SLK15L5R2	20-7	SLK2L5SE250	20-9
SLK15L10LP	20-8	SLK15L5SE250	20-9	SLK2L5SE375	20-9
SLK15L10T	20-11	SLK15L5SF	20-3	SLK2L5WA6	20-10
SLK15L1AB	20-2	SLK15L5T	20-11	SLK2L7	20-7
SLK15L1LP	20-8	SLK15L5WA6	20-10	SLK2L7LP	20-8
SLK15L1LPR2	20-8	SLK15L7LP	20-8	SLK2Y300L10	20-13
SLK15L1SF	20-3	SLK15L7T	20-11	SLK2Y300L2	20-13
SLK15L1T	20-11	SLK15Y300L3	20-13	SLK2Y300L3	20-13
SLK15L1TR2	20-11	SLK15Y300L3R2	20-13	SLK2Y300L3R2	20-13
SLK15L1WA6	20-10	SLK15Y300L5	20-13	SLK2Y300L5	20-13
SLK15L2	20-7	SLK15Y500L3	20-13	SLK2Y300L7	20-13
SLK15L2AB	20-2	SLK15Y500L3R2	20-13	SLK2Y500L3	20-13
SLK15L2DH	20-5	SLK2C200	20-22	SLK2YH500L2	20-12
SLK15L2GBSF	20-4	SLK2C50	20-22	SLK2YH500L2R2	20-12
SLK15L2LP	20-8	SLK2L1	20-7	SLK2YH500L3	20-12
SLK15L2LPR2	20-8	SLK2L10	20-7	SLK2YH500L3R2	20-12
SLK15L2R2	20-7	SLK2L100PACK	20-21	SLK2YH500L7	20-12
SLK15L2SE250	20-9	SLK2L10LP	20-8	SLK3C200	20-22
SLK15L2SF	20-3	SLK2L1LP	20-8	SLK3C50	20-22
SLK15L2T	20-11	SLK2L2	20-7	SLK3L1	20-7
SLK15L2TR2	20-11	SLK2L2AB	20-2	SLK3L10	20-7
SLK15L2WA6	20-10	SLK2L2GBSF	20-4	SLK3L10AB	20-2
SLK15L3	20-7	SLK2L2LP	20-8	SLK3L10LP	20-8
SLK15L34H24	20-6	SLK2L2R2	20-7	SLK3L10WA6	20-10
SLK15L34H58	20-6	SLK2L2SE250	20-9	SLK3L1LP	20-8
SLK15L3AB	20-2	SLK2L2SF	20-3	SLK3L1SE375	20-9
SLK15L3DH	20-5	SLK2L2WA6	20-10	SLK3L2	20-7
SLK15L3GBSF	20-4	SLK2L3	20-7	SLK3L2LP	20-8



# Index

Part No.	Page	Part No.	Page	Part No.	Page
SLK3L2SE375	20-9	SOSR150	6-4	TSM0050	7-4
SLK3L2WA6	20-10	SOSR200	6-4	TSM0062	7-4
SLK3L3	20-7	SPRA0025EG	27-14	TSM0075	7-4
SLK3L3LP	20-8	SPRA0037EG	27-14	TSM0087	7-4
SLK3L3R2	20-7	SPRA0050EG	27-14	TSM0112	7-4
SLK3L3SE375	20-9	SPRA0062EG	27-14	TSM0137	7-4
SLK3L5	20-7	SPRC0025EG	27-14	TSM0162	7-4
SLK3L5AB	20-2	SR0100EG	2-8	TSMI0062	7-5
SLK3L5LP	20-8	SR0125EG	2-8	TSMI0075	7-5
SLK3L5R2	20-7	SR0150EG	2-8	TSMI0087	7-5
SLK3L5WA6	20-10	SR0200EG	2-8	TSMI0100	7-5
SLK3L7AB	20-2	SR6	2-6	TSMI0112	7-5
SLK3L7SE375	20-9	STCB6	27-26	TSMI0125	7-5
SLS2C50	20-23	STS	27-11	TSMI0137	7-5
SLS2L1	20-15	SWFF0037EG	25-5	TSMI0150	7-5
SLS2L10	20-15	SWFF0050EG	25-5	TSMI0162	7-5
SLS2L2	20-15	SWMF0037EG	25-5	TSMI0200	7-5
SLS2L2SE250	20-16	SWMF0050EG	25-5	TSMI0212	7-5
SLS2L3	20-15	TCB	16-4	TSNT0025EG	27-15
SLS2L3DH	20-14	TDH	10-2	TSNT0037EG	27-15
SLS2L3SE250	20-16	TDHP2	10-3	TSNT0050EG	27-15
SLS2L3WA6	20-17	TDHP2PR10	10-3	TSR1220	27-2
SLS2L5SE250	20-16	TDHT4	10-2	TSR122025	27-2
SLS2L5WA6	20-17	TDHT6	10-2	TSR122038RL	8-13
SLS2L7DH	20-14	TPC112	5-6	TSR122038RL	27-5
SLS3C50	20-23	TPC238	5-6	TSR1220N	27-3
SLS3L1	20-15	TRC062	5-6	TSR1220R	27-4
SLS3L10	20-15	TRC075	5-6	TSR1220SLS3	20-18
SLS3L2	20-15	TRC087	5-6	TSR1220SLS3	27-6
SLS3L3	20-15	TRC100	5-6	U24A0000EG	27-29
SLS3L5	20-15	TRC112	5-6	USC006EG	7-6
SLS3L7	20-15	TRC125	5-6	USC010BR	7-3
SLWC	20-24, 22-2	TRC137	5-6	USC010EG	7-6
SMS8	15-2	TRC150	5-6	USC013BR	7-3
SN25	8-15	TRC162	5-6	USC013EG	7-6
SN37	8-15	TRC200	5-6	USC016BR	7-3
SN50	8-15	TRC212	5-6	USC016EG	7-6
SNSW37	8-16	TSGB16	5-12	USC017EG	7-6
SNSW50	8-16	TSGB1624	5-12	USC017HD	7-7
SOSR075	6-4	TSGB1624S	5-11	USC020BR	7-3
SOSR100	6-4	TSGB24	5-12	USC020EG	7-6
SOSR125	6-4	TSM0037	7-4	USC020HD	7-7

# Index

Part No.	Page	Part No.	Page	Part No.	Page
USC021EG	7-6	USC086EG	7-6	W190000EG	27-23
USC021HD	7-7	USC086HD	7-7	W200000EG	27-24
USC022BR	7-3	USC093EG	7-6	ZAA180	27-30
USC022EG	7-6	USC101EG	7-6	ZGA512	27-29
USC025EG	7-6	USC107BR	7-3		
USC026EG	7-6	USC107EG	7-7		
USC026HD	7-7	USC113EG	7-7		
USC028BR	7-3	USC113HD	7-7		
USC028EG	7-6	USC121EG	7-7		
USC031EG	7-6	USC129BR	7-3		
USC031HD	7-7	USC129EG	7-7		
USC033EG	7-6	USC135EG	7-7		
USC033HD	7-7	USC143EG	7-7		
USC036BR	7-3	USC143HD	7-7		
USC036EG	7-6	USC152EG	7-7		
USC040BR	7-3	USC159BR	7-3		
USC040EG	7-6	USC159EG	7-7		
USC040HD	7-7	USC168EG	7-7		
USC042BR	7-3	USC168HD	7-7		
USC042EG	7-6	USC178EG	7-7		
USC042HD	7-7	USC191EG	7-7		
USC046EG	7-6	USC200EG	7-7		
USC046HD	7-7	USC208EG	7-7		
USC048EG	7-6	USC218EG	7-7		
USC048HD	7-7	USC218HD	7-7		
USC053BR	7-3	USC228EG	7-7		
USC053EG	7-6	USC254EG	7-7		
USC054BR	7-3	USC277EG	7-7		
USC054EG	7-6	USC277HD	7-7		
USC054HD	7-7	USC324EG	7-7		
USC058EG	7-6	USC324HD	7-7		
USC058HD	7-7	USC400EG	7-7		
USC060EG	7-6	VAFT	9-17		
USC060HD	7-7	VAFTR	9-17		
USC063EG	7-6	VF14	9-17		
USC068BR	7-3	VF144TI	17-10		
USC068EG	7-6	VF146A	17-9		
USC073EG	7-6	VF146T	17-10		
USC073HD	7-7	VF146TI	17-10		
USC076EG	7-6	VF14708	17-10		
USC080BR	7-3	VS200000	27-32		
USC080EG	7-6	W170000EG	27-23		

- 1
- 2
- 3
- 4
- 5
- 6
- 7
- 8
- 9
- 10
- 11
- 12
- 13
- 14
- 15
- 16
- 17
- 18
- 19
- 20

Our powerful portfolio of brands:

**CADDY ERICO HOFFMAN RAYCHEM SCHROFF TRACER**



**[nVent.com/CADDY](https://nVent.com/CADDY)**

©2022 nVent. All nVent marks and logos are owned or licensed by nVent Services GmbH or its affiliates. All other trademarks are the property of their respective owners. nVent reserves the right to change specifications without notice.

CADDY-CAT-CMC-Mechanical-USEN-2204